

TOSHIBA BIPOLAR DIGITAL INTEGRATED CIRCUIT SILICON MONOLITHIC

ULN2803AP,ULN2803AFW,ULN2804AP,ULN2804AFW (Manufactured by Toshiba Malaysia)

8CH DARLINGTON SINK DRIVER

The ULN2803AP / AFW Series are high-voltage, high-current darlington drivers comprised of eight NPN darlington pairs. All units feature integral clamp diodes for switching inductive loads. Applications include relay, hammer, lamp and display (LED) drivers.

FEATURES

- Output current (single output)
500 mA (Max.)
- High sustaining voltage output
50 V (Min.)
- Output clamp diodes
- Inputs compatible with various types of logic.
- Package Type-AP : DIP-18pin
- Package Type-AFW : SOL-18pin

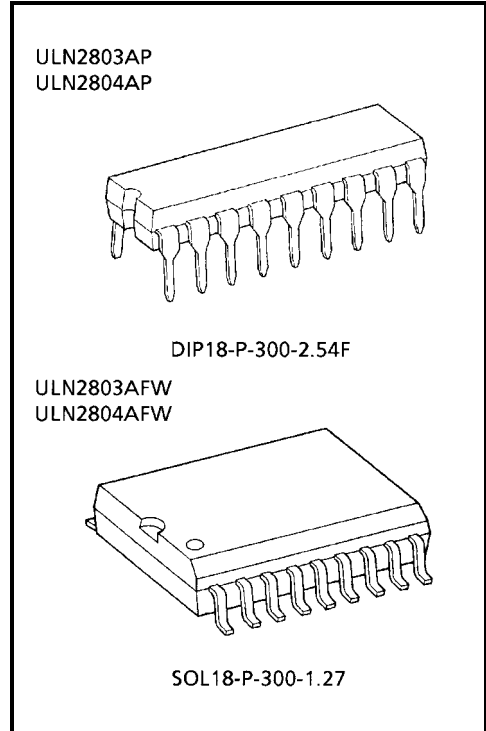

Weight
 DIP18-P-300-2.54F: 1.478 g (Typ.)
 SOL18-P-300-1.27 : 0.48 g (Typ.)

TYPE	INPUT BASE RESISTOR	DESIGNATION
ULN2803AP / AFW	2.7 kΩ	TTL, 5 V CMOS
ULN2804AP / AFW	10.5 kΩ	6~15 V PMOS, CMOS

PIN CONNECTION (TOP VIEW)

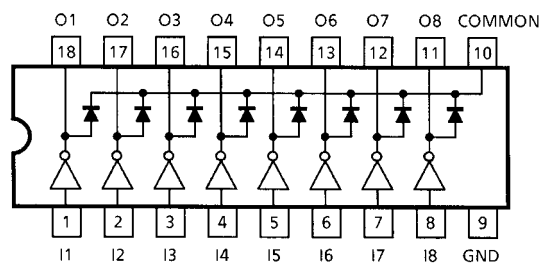

SCHEMATICS (EACH DRIVER)

ULN2803AP / AFW

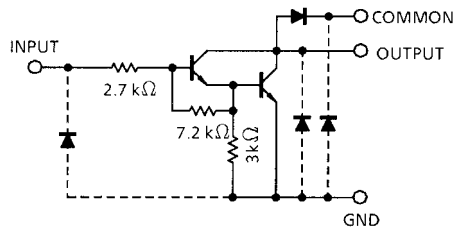

ULN2804AP / AFW

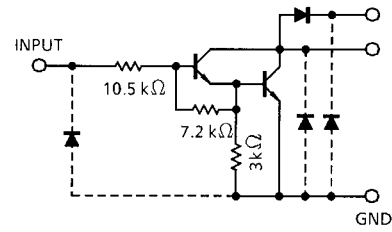

Note: The input and output parasitic diodes cannot be used as clamp diodes.

MAXIMUM RATINGS (Ta = 25°C)

CHARACTERISTIC	SYMBOL	RATING	UNIT
Output Sustaining Voltage	$V_{CE(SUS)}$	-0.5~50	V
Output Current	I_{OUT}	500	mA / ch
Input Voltage	V_{IN}	-0.5~30	V
Clamp Diode Reverse Voltage	V_R	50	V
Clamp Diode Forward Current	I_F	500	mA
Power Dissipation	AP	P_D	W
	AFW		
Operating Temperature	T_{opr}	-40~85	°C
Storage Temperature	T_{stg}	-55~150	°C

Note: On Glass Epoxy PCB (75 × 114 × 1.6 mm Cu 20%)

RECOMMENDED OPERATING CONDITIONS (Ta = -40~85°C)

CHARACTERISTIC		SYMBOL	TEST CONDITION	MIN	TYP.	MAX	UNIT
Output Sustaining Voltage		V _{CE (SUS)}		0	—	50	V
Output Current	AP	I _{OUT}	T _{pw} = 25 ms, Duty = 10%, 8 Circuits	0	—	347	mA / ch
			T _{pw} = 25 ms, Duty = 50%, 8 Circuits	0	—	123	
	AFW		T _{pw} = 25 ms, Duty = 10%, 8 Circuits	0	—	268	
			T _{pw} = 25 ms, Duty = 50%, 8 Circuits	0	—	90	
Input Voltage		V _{IN}		0	—	30	V
Input Voltage (Output On)	ULN2803AP / AFW	V _{IN (ON)}		3.5	—	30	V
	ULN2804AP / AFW			8	—	30	
Clamp Diode Reverse Voltage		V _R		—	—	50	V
Clamp Diode Forward Current		I _F		—	—	400	mA
Power Dissipation	AP	P _D	Ta = 85°C	—	—	0.76	W
	AFW		Ta = 85°C (Note)	—	—	0.48	

Note: On Glass Epoxy PCB (75 × 114 × 1.6 mm Cu 20%)

ELECTRICAL CHARACTERISTICS (Ta = 25°C)

CHARACTERISTIC		SYMBOL	TEST CIR-CUIT	TEST CONDITION	MIN	TYP.	MAX	UNIT
Output Leakage Current	ULN2804AP / AFW	I _{CEX}	1	V _{CE} = 50 V, Ta = 25°C	—	—	50	μA
				V _{CE} = 50 V, Ta = 85°C	—	—	100	
				V _{CE} = 50 V, V _{IN} = 1 V	—	—	500	
Collector-Emitter Saturation Voltage		V _{CE (sat)}	2	I _{OUT} = 350 mA, I _{IN} = 500 μA	—	1.3	1.6	V
				I _{OUT} = 200 mA, I _{IN} = 350 μA	—	1.1	1.3	
				I _{OUT} = 100 mA, I _{IN} = 250 μA	—	0.9	1.1	
Input Current	ULN2803AP / AFW	I _{IN (ON)}	2	V _{IN} = 3.85 V	—	0.93	1.35	mA
	ULN2804AP / AFW			V _{IN} = 5 V	—	0.35	0.5	
				V _{IN} = 12 V	—	1.0	1.45	
		I _{IN (OFF)}	4	I _{OUT} = 500 μA, Ta = 85°C	50	65	—	μA
Input Voltage (Output On)	ULN2803AP / AFW	V _{IN (ON)}	5	V _{CE} = 2 V, I _{OUT} = 200 mA	—	—	2.4	V
				V _{CE} = 2 V, I _{OUT} = 250 mA	—	—	2.7	
				V _{CE} = 2 V, I _{OUT} = 300 mA	—	—	3.0	
	ULN2804AP / AFW			V _{CE} = 2 V, I _{OUT} = 125 mA	—	—	5.0	
				V _{CE} = 2 V, I _{OUT} = 200 mA	—	—	6.0	
				V _{CE} = 2 V, I _{OUT} = 275 mA	—	—	7.0	
				V _{CE} = 2 V, I _{OUT} = 350 mA	—	—	8.0	
DC Current Transfer Ratio		h _{FE}	2	V _{CE} = 2 V, I _{OUT} = 350 mA	1000	—	—	
Clamp Diode Reverse Current		I _R	6	Ta = 25°C (Note)	—	—	50	μA
				Ta = 85°C (Note)	—	—	100	
Clamp Diode Forward Voltage		V _F	7	I _F = 350 mA	—	—	2.0	V
Input Capacitance		C _{IN}	—		—	15	—	pF
Turn-On Delay		t _{ON}	8	R _L = 125 Ω, V _{OUT} = 50 V	—	0.1	—	μs
Turn-Off Delay		t _{OFF}		R _L = 125 Ω, V _{OUT} = 50 V	—	0.2	—	

Note: V_R = V_R MAX.

TEST CIRCUIT

1. I_{CEX}

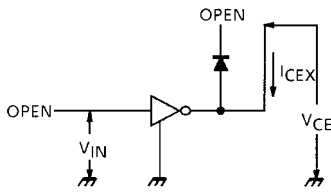

2. $V_{CE(sat)}$, h_{FE}

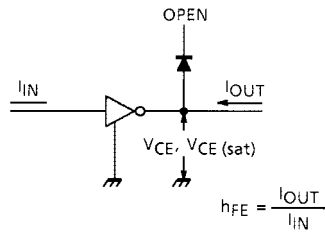

3. $I_{IN(ON)}$

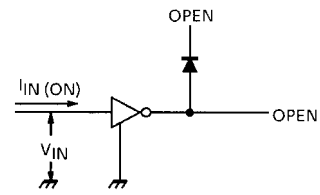

4. $I_{IN(OFF)}$

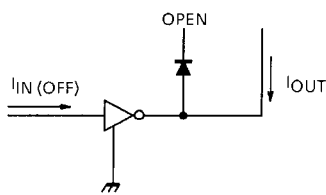

5. $V_{IN(ON)}$

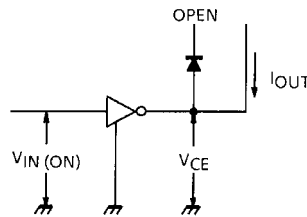

6. I_R

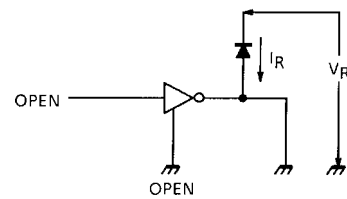

7. V_F

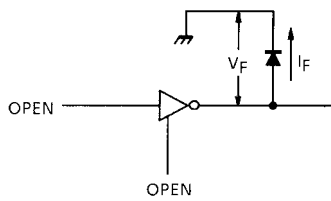

8. t_{ON} , t_{OFF}

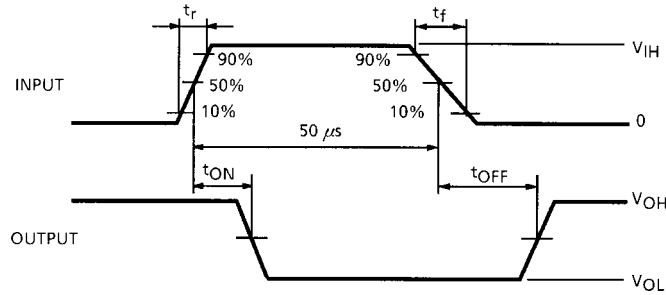
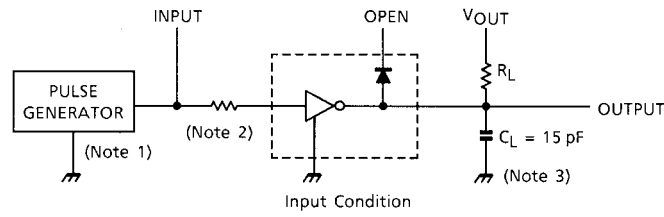

- Note 1: Pulse Width 50 μ s, Duty Cycle 10%
Output Impedance 50 Ω , $t_r \leq 5$ ns, $t_f \leq 10$ ns
- Note 2: See below.

INPUT CONDITION

TYPE NUMBER	R1	V_{IH}
ULN2803AP / AFW	0 Ω	3 V
ULN2804AP / AFW	0 Ω	8 V

Note 3: C_L includes probe and jig capacitance

PRECAUTIONS for USING

This IC does not integrate protection circuits such as overcurrent and overvoltage protectors. Thus, if excess current or voltage is applied to the IC, the IC may be damaged. Please design the IC so that excess current or voltage will not be applied to the IC. Utmost care is necessary in the design of the output line, COMMON and GND line since IC may be destroyed due to short-circuit between outputs, air contamination fault, or fault by improper grounding.

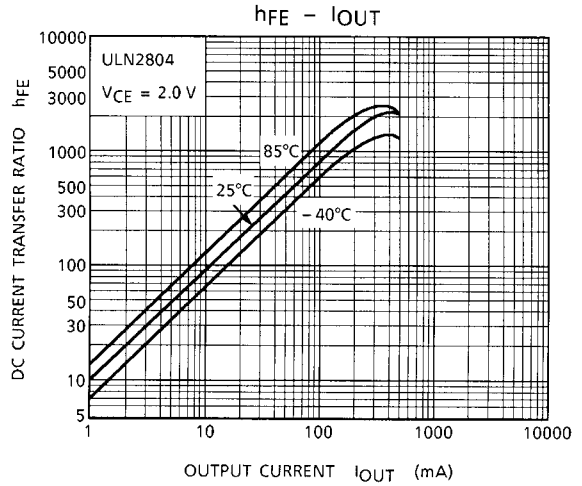
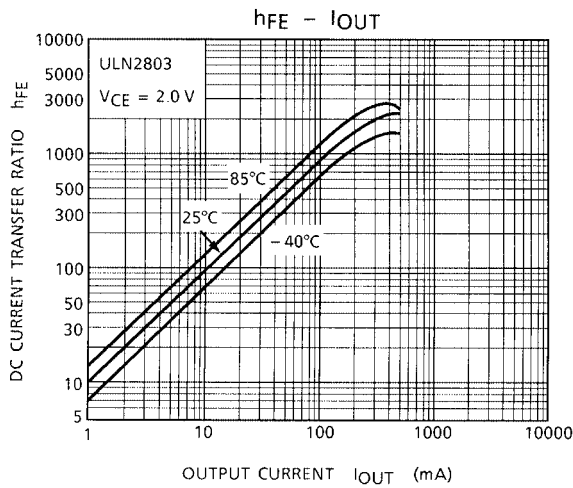
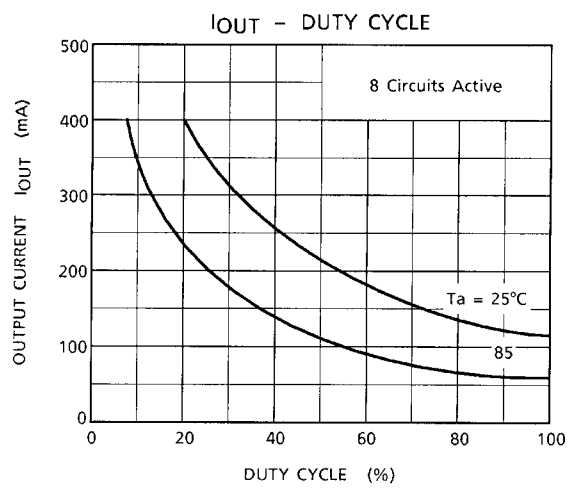
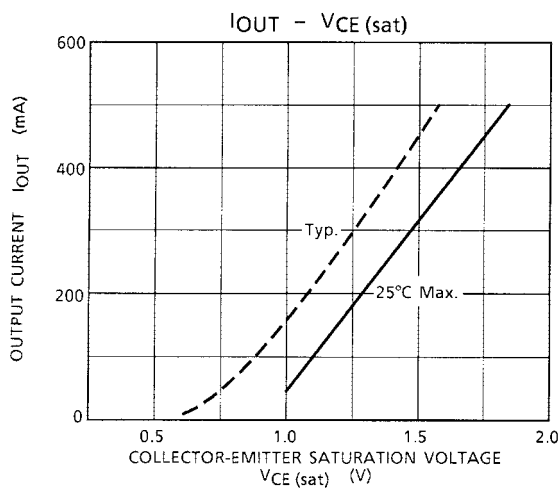
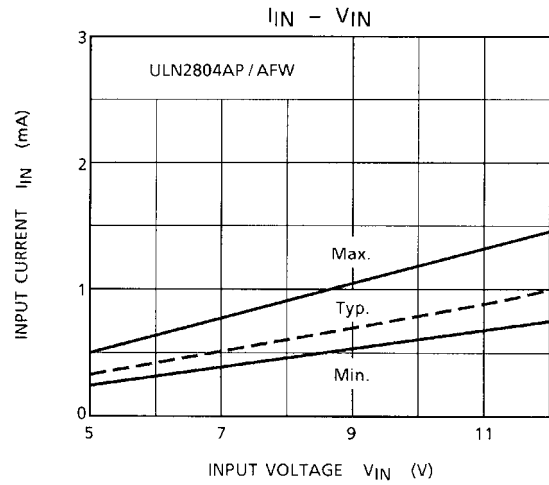
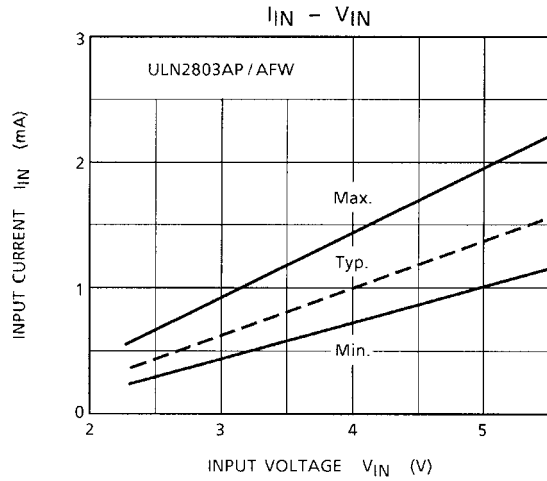

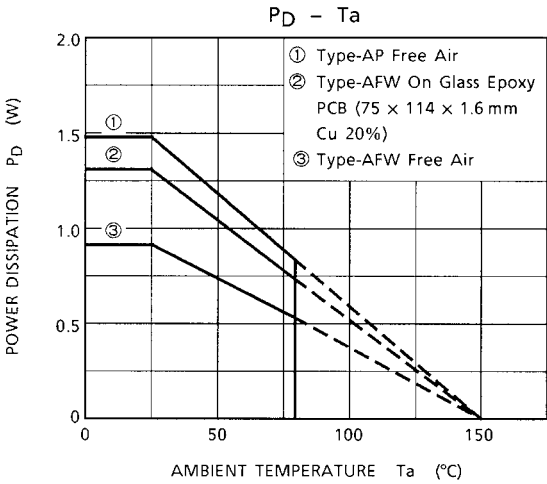

PACKAGE DIMENSIONS

DIP18-P-300-2.54F

Unit: mm

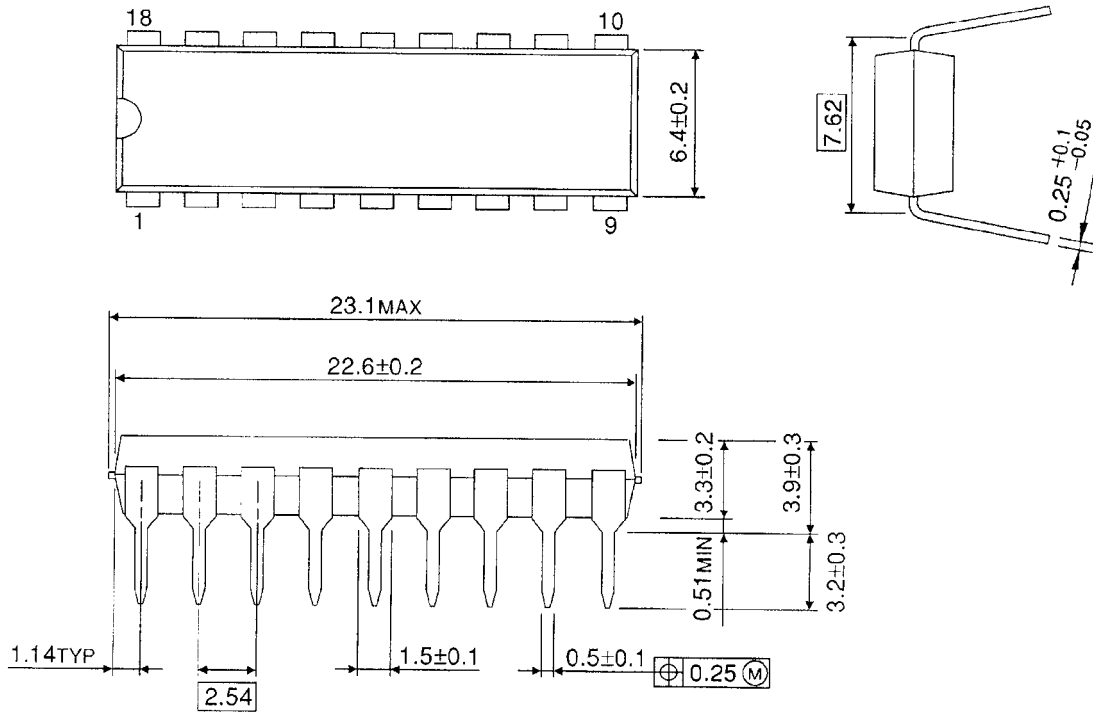

Weight: 1.478 g (Typ.)

PACKAGE DIMENSIONS

SOL18-P-300-1.27

Unit: mm

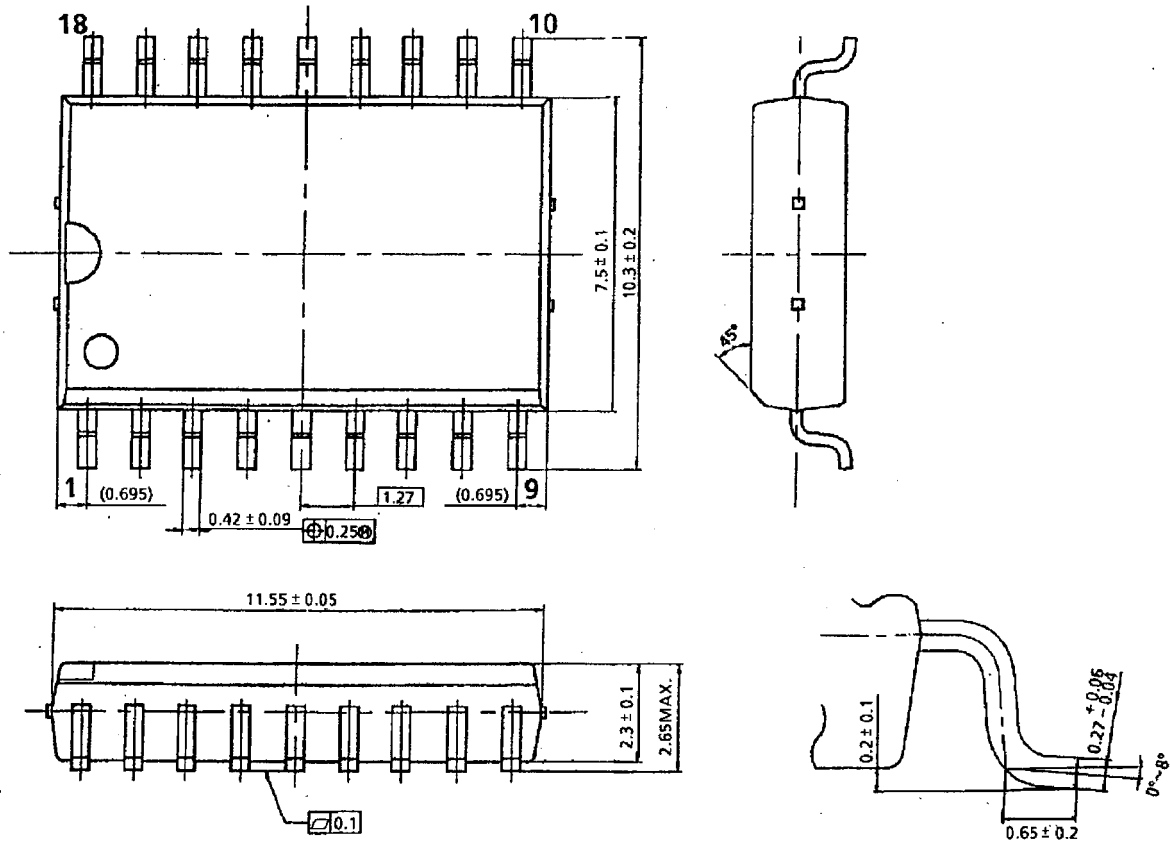

Weight: 0.48 g (Typ.)

RESTRICTIONS ON PRODUCT USE

000707EBA

- TOSHIBA is continually working to improve the quality and reliability of its products. Nevertheless, semiconductor devices in general can malfunction or fail due to their inherent electrical sensitivity and vulnerability to physical stress. It is the responsibility of the buyer, when utilizing TOSHIBA products, to comply with the standards of safety in making a safe design for the entire system, and to avoid situations in which a malfunction or failure of such TOSHIBA products could cause loss of human life, bodily injury or damage to property.
In developing your designs, please ensure that TOSHIBA products are used within specified operating ranges as set forth in the most recent TOSHIBA products specifications. Also, please keep in mind the precautions and conditions set forth in the "Handling Guide for Semiconductor Devices," or "TOSHIBA Semiconductor Reliability Handbook" etc..
- The TOSHIBA products listed in this document are intended for usage in general electronics applications (computer, personal equipment, office equipment, measuring equipment, industrial robotics, domestic appliances, etc.). These TOSHIBA products are neither intended nor warranted for usage in equipment that requires extraordinarily high quality and/or reliability or a malfunction or failure of which may cause loss of human life or bodily injury ("Unintended Usage"). Unintended Usage include atomic energy control instruments, airplane or spaceship instruments, transportation instruments, traffic signal instruments, combustion control instruments, medical instruments, all types of safety devices, etc.. Unintended Usage of TOSHIBA products listed in this document shall be made at the customer's own risk.
- The products described in this document are subject to the foreign exchange and foreign trade laws.
- The information contained herein is presented only as a guide for the applications of our products. No responsibility is assumed by TOSHIBA CORPORATION for any infringements of intellectual property or other rights of the third parties which may result from its use. No license is granted by implication or otherwise under any intellectual property or other rights of TOSHIBA CORPORATION or others.
- The information contained herein is subject to change without notice.