

ULx2803, ULx2804, ULx2823, and ULx2824

High Voltage High Current Darlington Arrays

Discontinued Product

These parts are no longer in production. The device should not be purchased for new design applications. Samples are no longer available.

Date of status change: October 31, 2005

Recommended Substitutions:

NOTE: For detailed information on purchasing options, contact your local Allegro field applications engineer or sales representative.

Allegro MicroSystems, Inc. reserves the right to make, from time to time, revisions to the anticipated product life cycle plan for a product to accommodate changes in production capabilities, alternative product availabilities, or market demand. The information included herein is believed to be accurate and reliable. However, Allegro MicroSystems, Inc. assumes no responsibility for its use; nor for any infringements of patents or other rights of third parties which may result from its use.



2803 THRU 2824 HIGH-VOLTAGE, HIGH-CURRENT DARLINGTON ARRAYS

DEVICE PART NUMBER DESIGNATION

| | | |
|----------------------|-------------------------|------------------------|
| $V_{CE(MAX)}$ | 50 V | 95 V |
| $I_{C(MAX)}$ | 500 mA | 500 mA |
| Logic | Part Number | |
| 5V TTL, CMOS | ULN2803A* ULN2803LW* | ULN2823A* ULN2823LW |
| 6-15 V CMOS, PMOS | ULN2804A* ULN2804LW* | ULN2824A* ULN2824LW |

*Also available for operation between -40°C and +85°C. To order, change prefix from 'ULN' to 'ULQ'.

**The ULx2804, ULx2823, & ULx2824 are discontinued.
Shown for reference only.**

PARTIAL SCHEMATICS

ULx28x3A/LW (Each Driver)

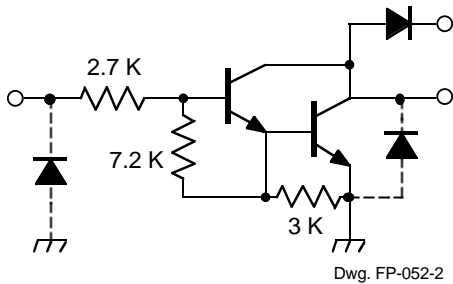

ULx28x4A/LW (Each Driver)

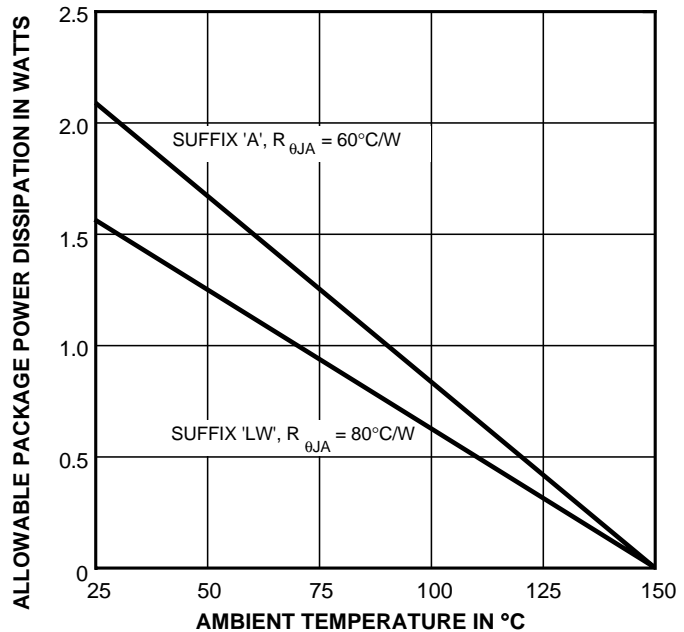
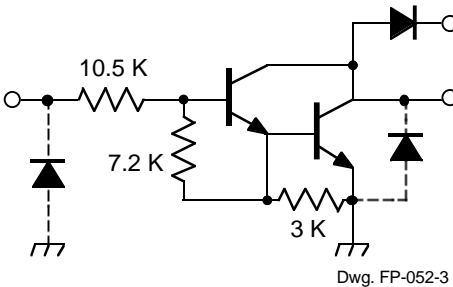

Dwg. GP-018B

x = Character to identify specific device. Specification shown applies to family of devices with remaining digits as shown. See matrix above.

2803 THRU 2824
HIGH-VOLTAGE,
HIGH-CURRENT
DARLINGTON ARRAYS

Types ULx2803A, ULx2803LW, ULx2804A, and ULx2804LW
ELECTRICAL CHARACTERISTICS at +25°C (unless otherwise noted).

| Characteristic | Symbol | Test Fig. | Applicable Devices | Test Conditions | Limits | | | |
|--------------------------------------|----------------------|-----------|--------------------|--|--------|------|------|-------|
| | | | | | Min. | Typ. | Max. | Units |
| Output Leakage Current | I _{CEX} | 1A | All | V _{CE} = 50 V, T _A = 25°C | — | < 1 | 50 | μA |
| | | | | V _{CE} = 50 V, T _A = 70°C | — | < 1 | 100 | μA |
| | | 1B | ULx2804x | V _{CE} = 50 V, T _A = 70°C, V _{IN} = 1.0 V | — | < 5 | 500 | μA |
| Collector-Emitter Saturation Voltage | V _{CE(SAT)} | 2 | All | I _C = 100 mA, I _B = 250 μA | — | 0.9 | 1.1 | V |
| | | | | I _C = 200 mA, I _B = 350 μA | — | 1.1 | 1.3 | V |
| | | | | I _C = 350 mA, I _B = 500 μA | — | 1.3 | 1.6 | V |
| Input Current | I _{IN(ON)} | 3 | ULx2803x | V _{IN} = 3.85 V | — | 0.93 | 1.35 | mA |
| | | | ULx2804x | V _{IN} = 5.0 V | — | 0.35 | 0.5 | mA |
| | | | ULx2804x | V _{IN} = 12 V | — | 1.0 | 1.45 | mA |
| | I _{IN(OFF)} | 4 | All | I _C = 500 μA, T _A = 70°C | 50 | 65 | — | μA |
| Input Voltage | V _{IN(ON)} | 5 | ULx2803x | V _{CE} = 2.0 V, I _C = 200 mA | — | — | 2.4 | V |
| | | | | V _{CE} = 2.0 V, I _C = 250 mA | — | — | 2.7 | V |
| | | | | V _{CE} = 2.0 V, I _C = 300 mA | — | — | 3.0 | V |
| | | | ULx2804x | V _{CE} = 2.0 V, I _C = 125 mA | — | — | 5.0 | V |
| | | | | V _{CE} = 2.0 V, I _C = 200 mA | — | — | 6.0 | V |
| | | | | V _{CE} = 2.0 V, I _C = 275 mA | — | — | 7.0 | V |
| | | | | V _{CE} = 2.0 V, I _C = 350 mA | — | — | 8.0 | V |
| Input Capacitance | C _{IN} | — | All | | — | 15 | 25 | pF |
| Turn-On Delay | t _{PLH} | 8 | All | 0.5 E _{IN} to 0.5 E _{OUT} | — | 0.25 | 1.0 | μs |
| Turn-Off Delay | t _{PHL} | 8 | All | 0.5 E _{IN} to 0.5 E _{OUT} | — | 0.25 | 1.0 | μs |
| Clamp Diode Leakage Current | I _R | 6 | All | V _R = 50 V, T _A = 25°C | — | — | 50 | μA |
| | | | | V _R = 50 V, T _A = 70°C | — | — | 100 | μA |
| Clamp Diode Forward Voltage | V _F | 7 | All | I _F = 350 mA | — | 1.7 | 2.0 | V |

Complete part number includes prefix to operating temperature range: ULN = -20°C to +85°C, ULQ = -40°C to +85°C and a suffix to identify package style: A = DIP, LW = SOIC.

The ULx2804 is discontinued.
Shown for reference only.

2803 THRU 2824 HIGH-VOLTAGE, HIGH-CURRENT DARLINGTON ARRAYS

Types ULx2823A, ULN2823LW, ULx2824A, and ULN2824LW ELECTRICAL CHARACTERISTICS at +25°C (unless otherwise noted).

| Characteristic | Symbol | Test Fig. | Applicable Devices | Test Conditions | Limits | | | |
|--------------------------------------|---------------|-----------|--------------------|---|--------|------|------|---------------|
| | | | | | Min. | Typ. | Max. | Units |
| Output Leakage Current | I_{CEX} | 1A | All | $V_{CE} = 95\text{ V}, T_A = 25^\circ\text{C}$ | — | < 1 | 50 | μA |
| | | | | $V_{CE} = 95\text{ V}, T_A = 70^\circ\text{C}$ | — | < 1 | 100 | μA |
| | | 1B | ULx2824x | $V_{CE} = 95\text{ V}, T_A = 70^\circ\text{C}, V_{IN} = 1.0\text{ V}$ | — | < 5 | 500 | μA |
| Collector-Emitter Saturation Voltage | $V_{CE(SAT)}$ | 2 | All | $I_C = 100\text{ mA}, I_B = 250\text{ }\mu\text{A}$ | — | 0.9 | 1.1 | V |
| | | | | $I_C = 200\text{ mA}, I_B = 350\text{ }\mu\text{A}$ | — | 1.1 | 1.3 | V |
| | | | | $I_C = 350\text{ mA}, I_B = 500\text{ }\mu\text{A}$ | — | 1.3 | 1.6 | V |
| Input Current | $I_{IN(ON)}$ | 3 | ULx2823x | $V_{IN} = 3.85\text{ V}$ | — | 0.93 | 1.35 | mA |
| | | | ULx2824x | $V_{IN} = 5.0\text{ V}$ | — | 0.35 | 0.5 | mA |
| | | | | $V_{IN} = 12\text{ V}$ | — | 1.0 | 1.45 | mA |
| | $I_{IN(OFF)}$ | 4 | All | $I_C = 500\text{ }\mu\text{A}, T_A = 70^\circ\text{C}$ | 50 | 65 | — | μA |
| Input Voltage | $V_{IN(ON)}$ | 5 | ULx2823x | $V_{CE} = 2.0\text{ V}, I_C = 200\text{ mA}$ | — | — | 2.4 | V |
| | | | | $V_{CE} = 2.0\text{ V}, I_C = 250\text{ mA}$ | — | — | 2.7 | V |
| | | | | $V_{CE} = 2.0\text{ V}, I_C = 300\text{ mA}$ | — | — | 3.0 | V |
| | | | ULx2824x | $V_{CE} = 2.0\text{ V}, I_C = 125\text{ mA}$ | — | — | 5.0 | V |
| | | | | $V_{CE} = 2.0\text{ V}, I_C = 200\text{ mA}$ | — | — | 6.0 | V |
| | | | | $V_{CE} = 2.0\text{ V}, I_C = 275\text{ mA}$ | — | — | 7.0 | V |
| | | | | $V_{CE} = 2.0\text{ V}, I_C = 350\text{ mA}$ | — | — | 8.0 | V |
| Input Capacitance | C_{IN} | — | All | | — | 15 | 25 | pF |
| Turn-On Delay | t_{PLH} | 8 | All | $0.5 E_{IN}$ to $0.5 E_{OUT}$ | — | 0.25 | 1.0 | μs |
| Turn-Off Delay | t_{PHL} | 8 | All | $0.5 E_{IN}$ to $0.5 E_{OUT}$ | — | 0.25 | 1.0 | μs |
| Clamp Diode Leakage Current | I_R | 6 | All | $V_R = 95\text{ V}, T_A = 25^\circ\text{C}$ | — | — | 50 | μA |
| | | | | $V_R = 95\text{ V}, T_A = 70^\circ\text{C}$ | — | — | 100 | μA |
| Clamp Diode Forward Voltage | V_F | 7 | All | $I_F = 350\text{ mA}$ | — | 1.7 | 2.0 | V |

Complete part number includes prefix to operating temperature range: ULN = -20°C to +85°C, ULQ = -40°C to +85°C and a suffix to identify package style: A = DIP, LW = SOIC. Note that the ULQ2823LW and ULQ2824LW are not presently available.

**The ULx2823 & ULx2824 are discontinued.
Shown for reference only.**

2803 THRU 2824 HIGH-VOLTAGE, HIGH-CURRENT DARLINGTON ARRAYS

TEST FIGURES

FIGURE 1A

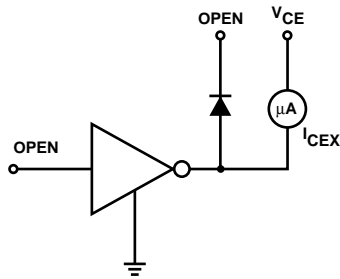

Dwg. No. A-9729A

FIGURE 1B

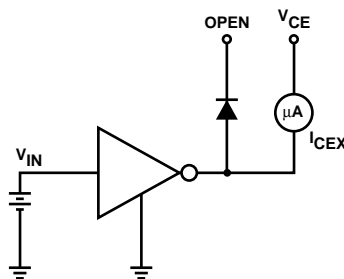

Dwg. No. A-9730A

FIGURE 2

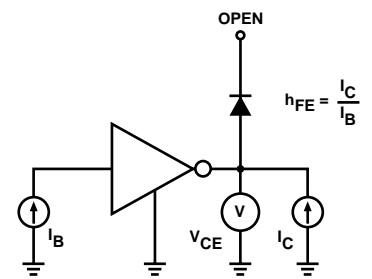

Dwg. No. A-9731A

FIGURE 3

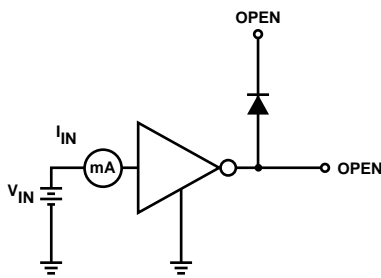

Dwg. No. A-9732A

FIGURE 4

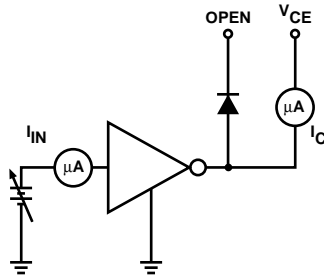

Dwg. No. A-9733A

FIGURE 5

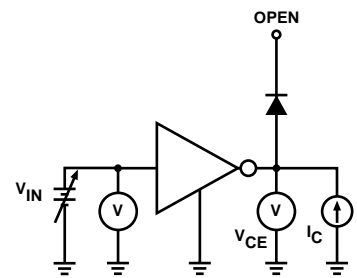

Dwg. No. A-9734A

FIGURE 6

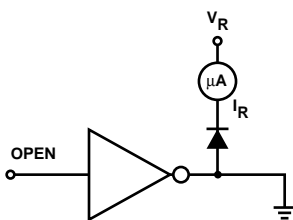

Dwg. No. A-9735A

FIGURE 7

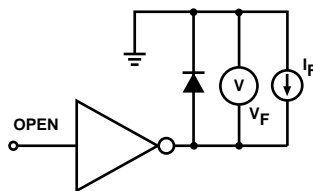

Dwg. No. A-9736A

FIGURE 8

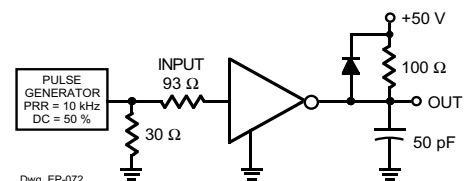

Dwg. EP-072

| | V_{in} |
|----------|----------|
| ULx28x3x | 3.5 V |
| ULx28x4x | 12 V |

2803 THRU 2824 HIGH-VOLTAGE, HIGH-CURRENT DARLINGTON ARRAYS

**ALLOWABLE COLLECTOR CURRENT
AS A FUNCTION OF DUTY CYCLE**
ULx28xxA

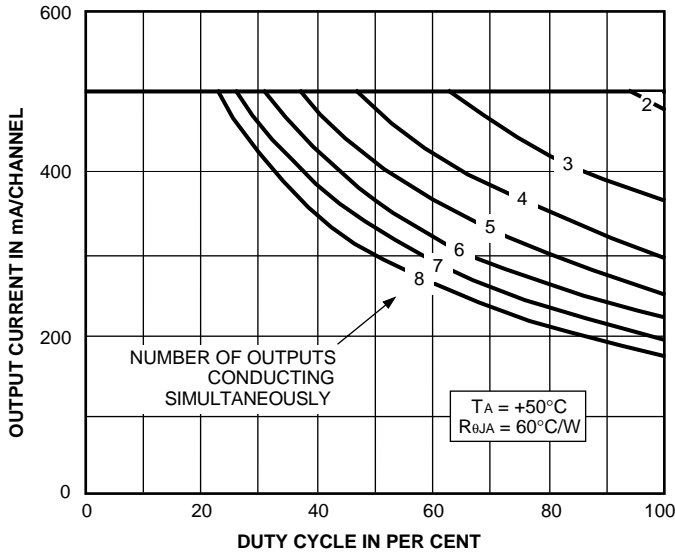

**ALLOWABLE COLLECTOR CURRENT
AS A FUNCTION OF DUTY CYCLE**
ULx28xxLW

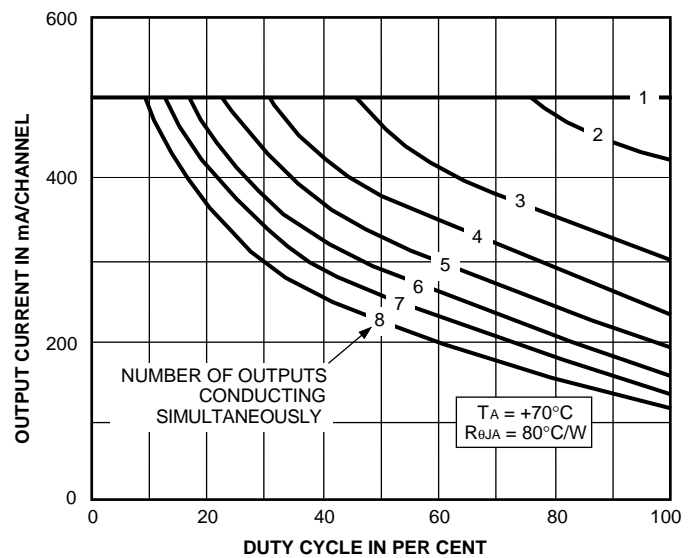
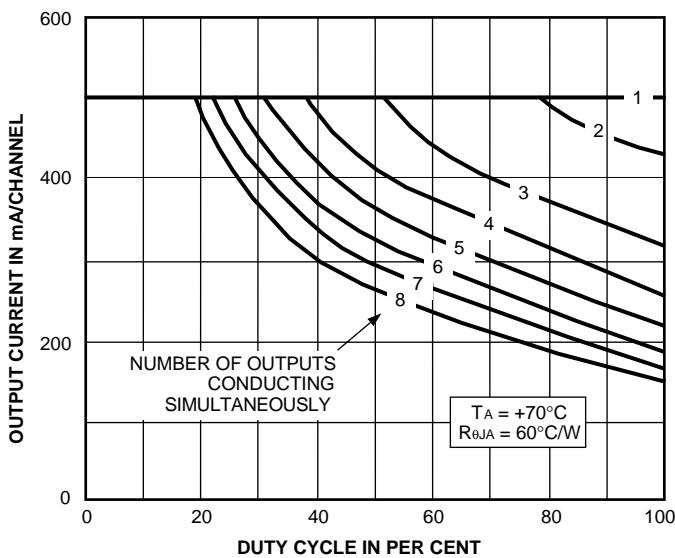
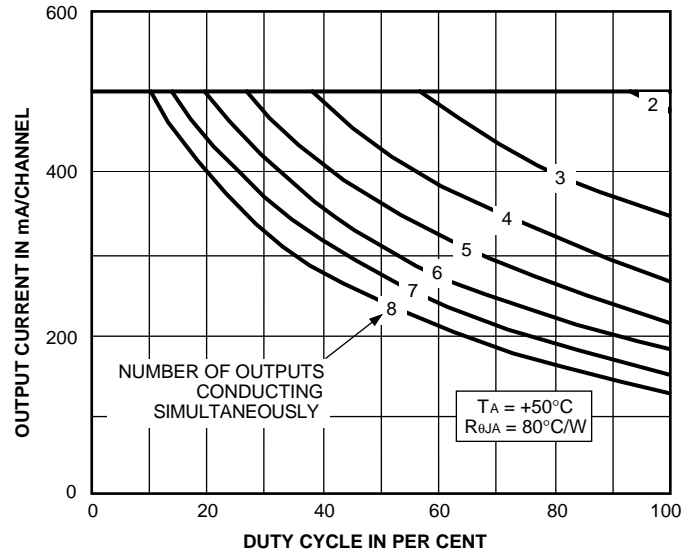

x = Characters to identify specific device. Specification shown applies to family of devices with remaining digits as shown.

2803 THRU 2824 HIGH-VOLTAGE, HIGH-CURRENT DARLINGTON ARRAYS

**INPUT CURRENT AS A
FUNCTION OF INPUT VOLTAGE**
ULx28x3x

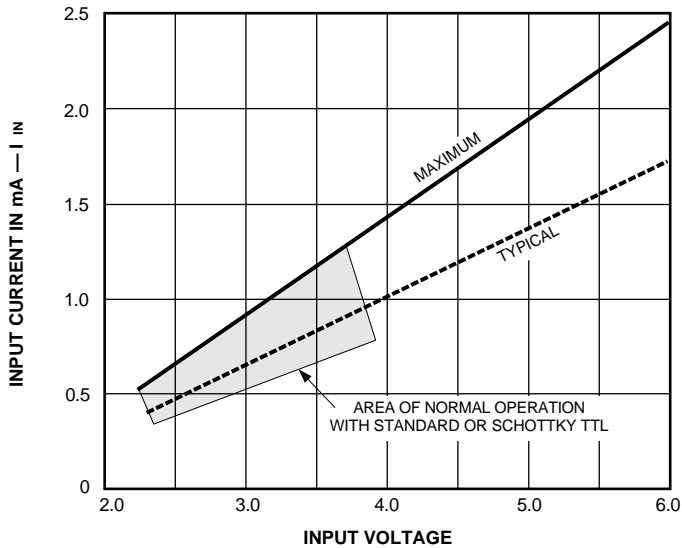

Dwg. GP-069

**SATURATION VOLTAGE AS A FUNCTION OF
COLLECTOR CURRENT**

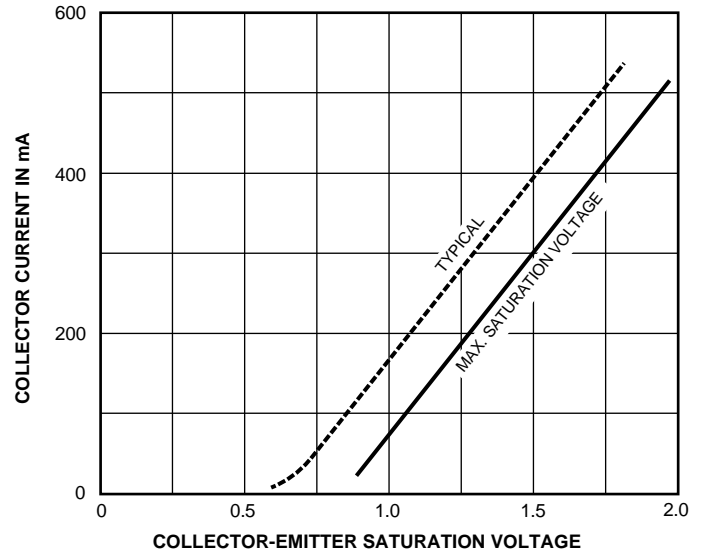

Dwg. GP-067

ULx28x4x

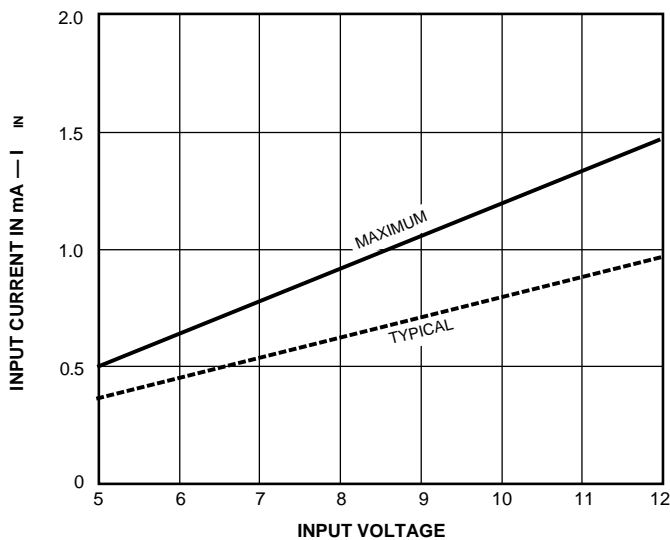

Dwg. GP-069-1

**COLLECTOR CURRENT AS A
FUNCTION OF INPUT CURRENT**

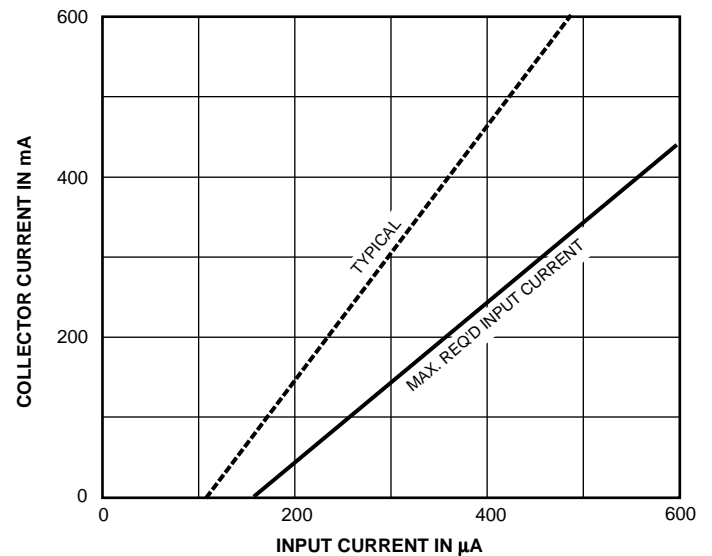

Dwg. GP-068

x = Characters to identify specific device. Characteristic shown applies to family of devices with remaining digits as shown.

**2803 THRU 2824
HIGH-VOLTAGE,
HIGH-CURRENT
DARLINGTON ARRAYS**

PACKAGE DESIGNATOR "A" DIMENSIONS

Dimensions in Inches
(controlling dimensions)

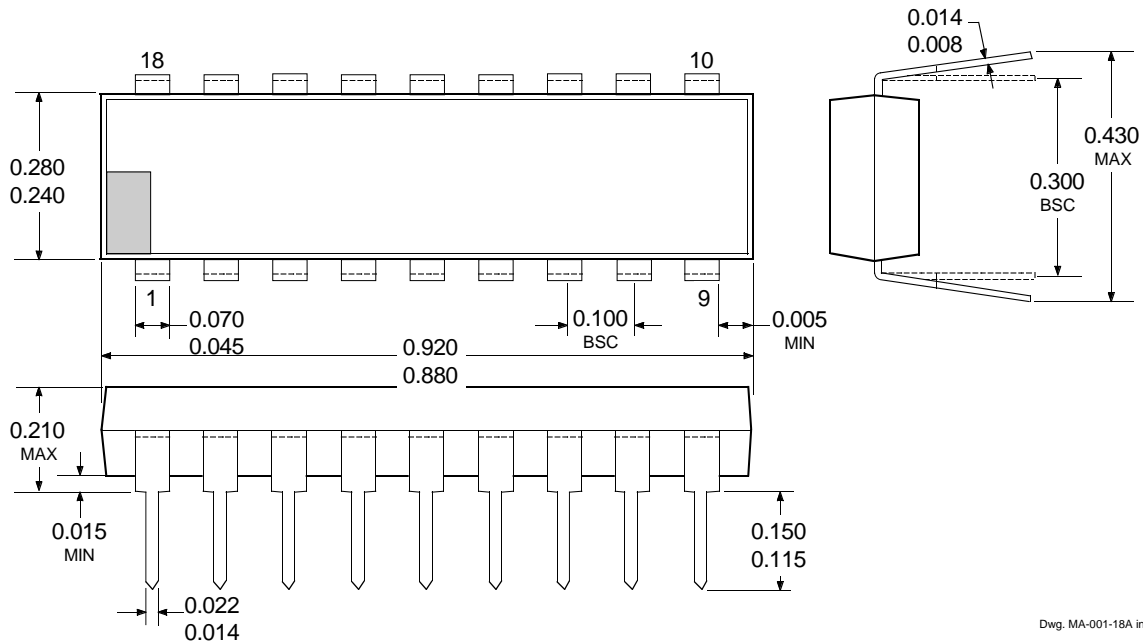

Dwg. MA-001-18A in

Dimensions in Millimeters
(for reference only)

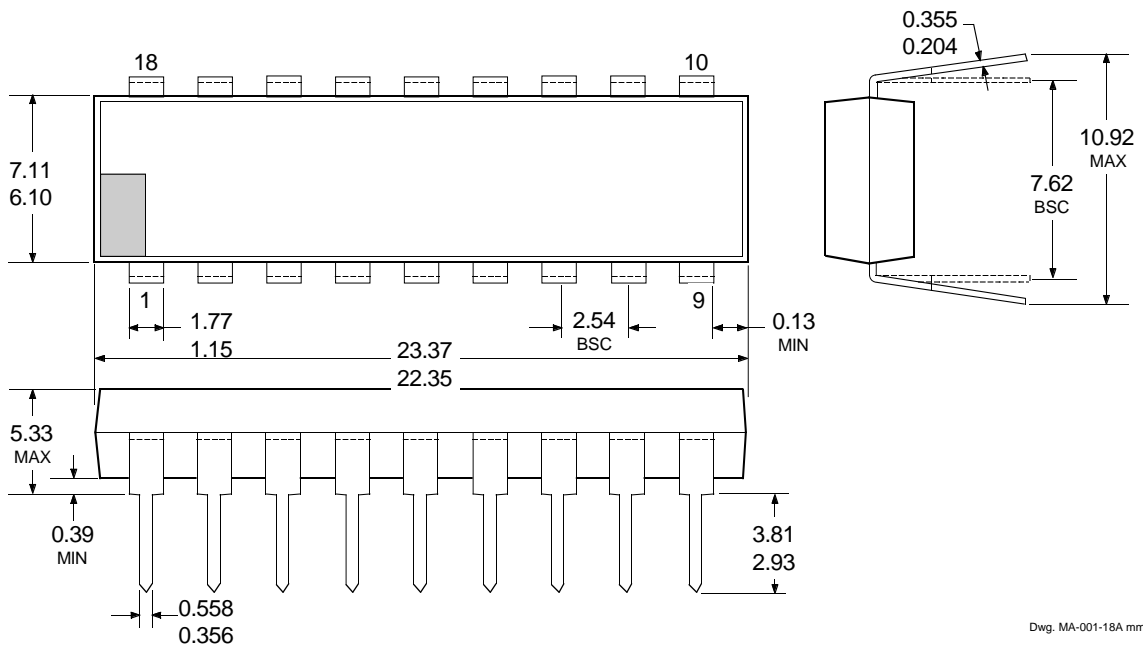

Dwg. MA-001-18A mm

- NOTES: 1. Exact body and lead configuration at vendor's option within limits shown.
2. Lead spacing tolerance is non-cumulative.
3. Lead thickness is measured at seating plane or below.

2803 THRU 2824 HIGH-VOLTAGE, HIGH-CURRENT DARLINGTON ARRAYS

PACKAGE DESIGNATOR "LW" DIMENSIONS

Dimensions in Inches
(for reference only)

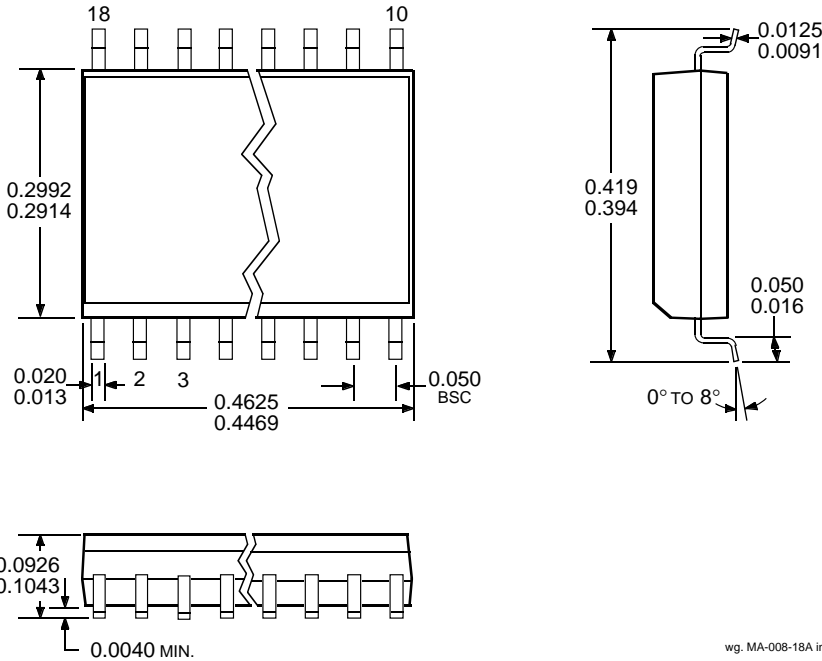

Dimensions in Millimeters
(controlling dimensions)

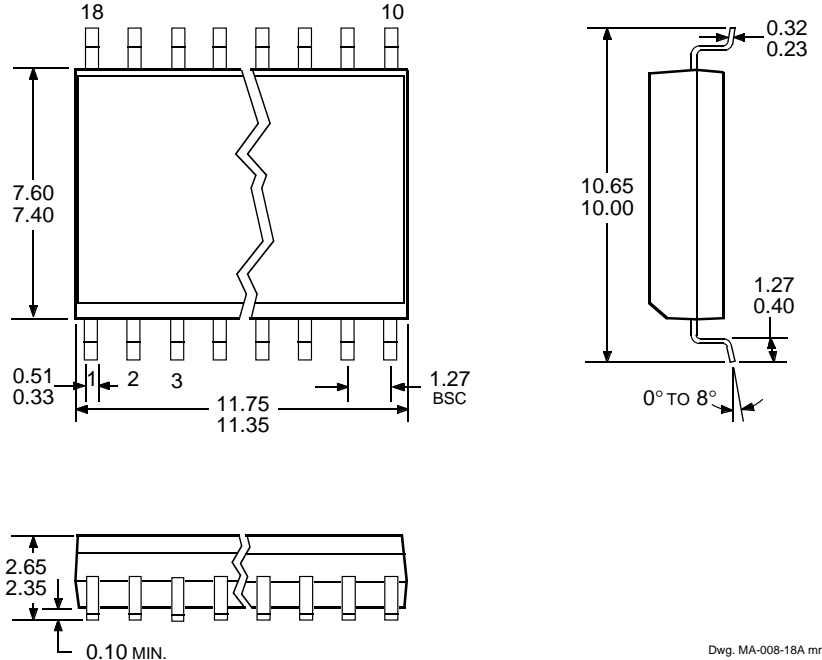

- NOTES: 1. Exact body and lead configuration at vendor's option within limits shown.
2. Lead spacing tolerance is non-cumulative.

2803 THRU 2824
HIGH-VOLTAGE,
HIGH-CURRENT
DARLINGTON ARRAYS

The products described here are manufactured under one or more U.S. patents or U.S. patents pending.

Allegro MicroSystems, Inc. reserves the right to make, from time to time, such departures from the detail specifications as may be required to permit improvements in the performance, reliability, or manufacturability of its products. Before placing an order, the user is cautioned to verify that the information being relied upon is current.

Allegro products are not authorized for use as critical components in life-support devices or systems without express written approval.

The information included herein is believed to be accurate and reliable. However, Allegro MicroSystems, Inc. assumes no responsibility for its use; nor for any infringement of patents or other rights of third parties which may result from its use.