

ULPMC10

Microcontroller for Struix System-in-Package (SiP)

Introduction

ULPMC10 is an industry-leading 32-bit microprocessor built around an ARM® Cortex®-M3 core that is designed for capturing and processing biometric signals within medical devices. ULPMC10 is ideally suited to be integrated with custom designed proprietary application specific integrated circuit (ASICs) within the Struix System-in-Package (SiP) solution from ON Semiconductor. This complete energy efficient solution enables manufacturers to develop miniature, high performance, low power, precision-sensing medical applications.

ULPMC10 delivers outstanding computational performance and exceptional system response to events, while meeting the challenges of low dynamic and static power constraints. The processor is highly configurable, enabling a wide range of medical implementations from those requiring low duty-cycle operations to size-sensitive devices requiring a minimal semiconductor footprint.

ULPMC10 features built-in, advanced power management including system monitoring for fail-safe operation. This allows for a wide variety of battery voltages for efficiently powering the device without the need for external, active components. It encompasses a combination of charge pump based power conversion and regulation providing an optimal balance between power and execution speed.

A comprehensive and easy-to-use suite of development tools is available from IAR Systems including CMSIS based software interfaces.

Key Features

Powerful and Efficient Processing Architecture

- 32-bit ARM Cortex-M3 Processor
- 512 kB On-chip Flash for Program and User Data Storage
- 24 kB On-chip SRAM Memory
- Flexible DMA, 2 General-purpose Timers, CRC Calculator
- No External Voltage Required for Flash Write Operation

Ultra Low-Power and Smart Power Management

- Less than 200 μA / MHz, up to 5 MHz Clock Speed
- Less than 400 μA / MHz, between 5 MHz and 40 MHz Clock Speed
- Flexible Input Voltage Range between 1.3 V; 3.6 V (3 V Nominal Supply Voltage)
- Ultra-low-current Sleep Mode with Real-time Clock Active (< 200 nA)
- On-chip Charge Pump for Effective Power Conversion and Powering of External, Devices such as Wireless Bluetooth® Low-energy

- Low-current Standby Mode with Real-time Clock Active, Register, and SRAM Retention (< 500 nA)
- Integrated Power Supplies Minimize Need for External Components, Only a Minimum of External Passives is Required

Clock Management

- Built-in RTC with External Crystal
- On-chip RC Oscillator for Internal Clock Generation up to 40 MHz
- Integrated PLL (up to 20 MHz Output Signal) – Allow for RTC Crystal only Operation (no Additional Crystal Required)
- Divider Structure to Efficiently Clock any Portion of the Device

Analog-to-Digital Conversion

- Single 12-bit ADC with 3 Multiplexed Inputs
- On-the-fly Data Rate Configurability

Temperature Sensor

- Built-in, Junction-based Temperature Sensor Covering 0°C up to 50°C



ON Semiconductor®

www.onsemi.com

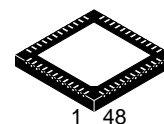

QFN48 6x6
CASE 485AN

MARKING DIAGRAM

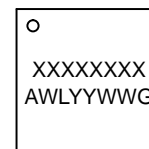

XXX = Specific Device Code
A = Assembly Location
WL = Wafer Lot
YY = Year
WW = Work Week
G = Pb-Free Package

ULPMC10

Digital Interface

- 24-pin DIO interface encompassing:
 - PWM for external actuator or sensor control
 - 2 SPI ports
 - UART
- PCM
- I²C
- JTAG (2-wire)
- GPIO
- IRQ

SYSTEM DIAGRAM

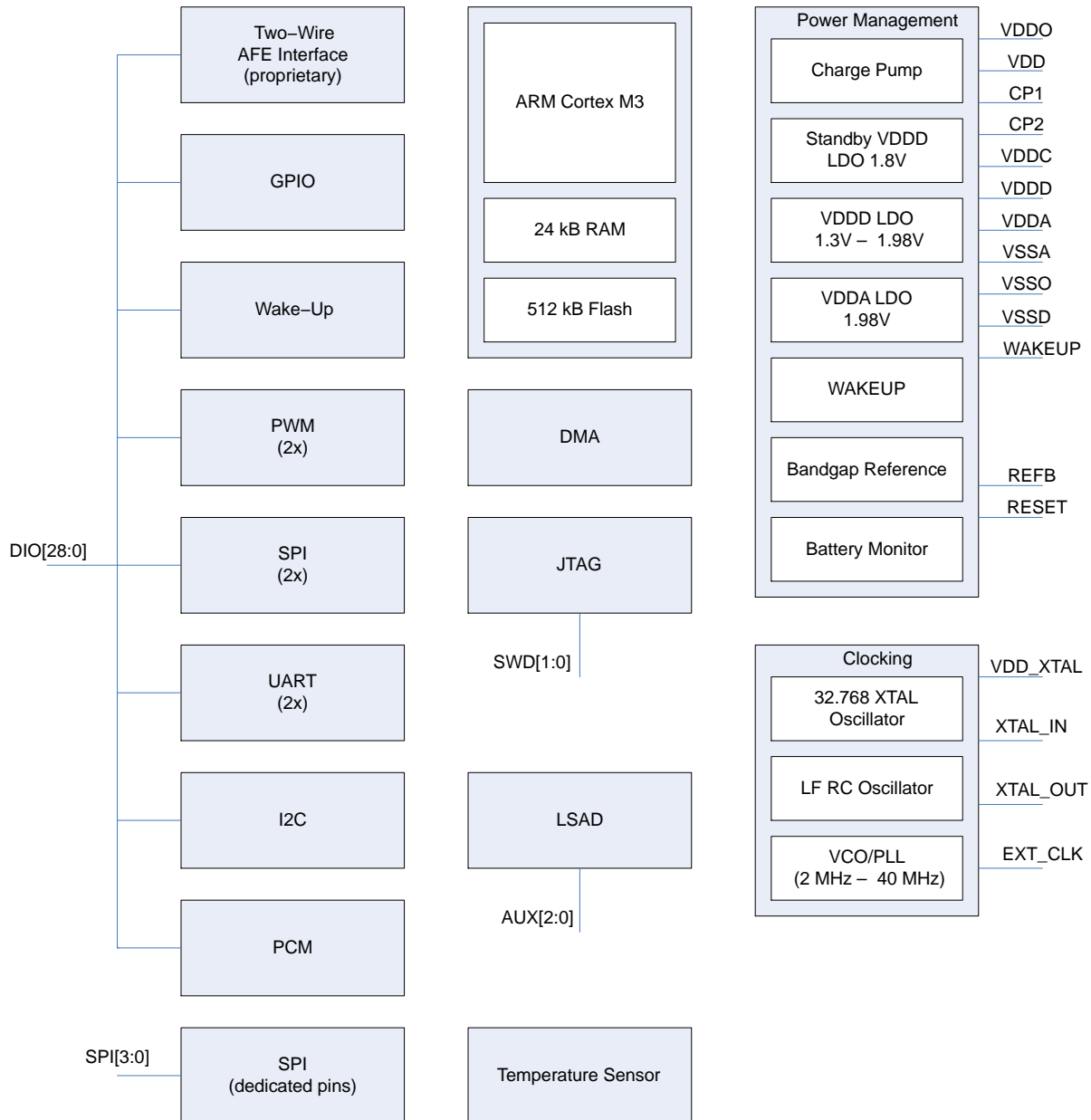

Figure 1. ULPMC10 System Overview

ULPMC10

ARCHITECTURE OVERVIEW

Operating Modes

Five low-power operating modes are available:

- Run mode
 - ◆ Run_Fast mode – used during normal program execution; the entire device is fully operational in Run mode
 - ◆ Run_Slow mode – used for lower current consumption, with slower program execution
- Standby mode – used for ultra-low current consumption, with no program execution but RAM and register retention
- Sleep mode – used for ultra low current consumption, with no program execution
- Shutdown mode – used for ultra low current consumption, with no program execution

Each mode is designed to provide the lowest possible current consumption, while maintaining power to specific parts of the device.

Run Mode

Run_Fast Mode

Run_Fast mode provides a low-power mode where the entire system is fully functional with a system clock up to 40 MHz. In Run_fast mode, the device enables the on-chip VDDD Digital Supply Regulator to provide power to the ARM Cortex-M3 processor. The processor is clocked from either an internal or an external clock source (via the PLL). The program can be executed from the internal flash or SRAM memory.

The application may also adjust the device clock frequency through the internal oscillator or through clock divisors to minimize power consumption. The Analog-to-Digital Converter (ADC) may be configured as required in run mode. Internal clock dividers provide all the necessary clocks to the peripherals.

While in Run mode, the application may switch into either Sleep mode, Standby mode, or Shutdown Mode.

Run_Slow Mode

Run_Slow mode is similar to Run_Fast mode except that the maximum system clock is 5 MHz.

Standby Mode

Deep Standby Mode

Deep Standby mode provides a low-power mode where the digital system state is retained. In Deep Standby mode, the ARM Cortex-M3 processor execution is paused and the VDDD Digital Supply Regulator voltage is reduced. The contents of all the registers and SRAM are retained and the RTC stays enabled.

When in Deep Standby mode, the device may be switched into Run_Fast or Run_Slow mode by either the RTC alarm or by up to four external events (through the Wakeup controller).

Fast Standby Mode

Fast Standby mode is similar to Deep Standby mode, except that it operates at a higher current and allows for a faster startup time.

You can find more details on Fast Standby mode in the Hardware Reference for the ULPMC10 Microcontroller manual, available on request from your ON Semiconductor sales support representative.

Sleep Mode

Sleep mode provides an ultra-low power mode where the system is waiting for a wakeup event. In sleep mode, the power supervisor automatically disables and powers down the digital and analog supply regulators and the internal oscillator. The RTC stays enabled.

When in sleep mode, the device may be switched into Run_Fast mode or Run_slow mode by either the RTC alarm or by up to four external events (through the Wakeup controller). After exiting Sleep mode, the system state is reset and execution starts from the beginning of the ROM program.

Shutdown Mode

Shutdown mode is similar to Sleep mode except that the RTC is disabled. This is lowest power mode for ULPMC10.

Power Supply

The device can be powered from a single battery supply such as a 2032 lithium coin cell or any other battery with a voltage between 1.3 V and 3.6 V. The device supplies all required regulated voltages and references on-chip. This allows the device to operate directly from a single battery supply without the need for external regulators or switches.

VDD

The main power supply input for the device is VDD. The supplied voltage to VDD is typically 3.3 V but VDD can be supplied with any voltage between 1.3 V and 3.6 V. The device will operate reliably across this entire power supply range. This flexibility allows for a wide range of battery types to be directly connected to the device. Note, for flash write VDD needs to be at least 1.8 V.

VDD is monitored by the built-in power supervisor.

Regulators

All required voltages for normal device operation are generated on-chip.

VDDD

The VDDD Digital Supply Regulator (VDDD) provides a nominal 1.3 V power supply for the digital domain on the chip (consisting of the ARM Cortex-M3 Processor, digital peripheral and memories, and on-chip flash) in case flash write access is not required and the system clock frequency is less than 5 MHz (Run_Slow Mode). If flash write access

is required or the system clock is greater than 5 MHz, VDDD provides a nominal 1.8 V voltage.

VDDC

An on-chip charge pump can be applied for effective power conversion when applying VDD voltages larger than 2.6 V. In this case, the charge pump divides the VDD voltage to create a divided voltage VDDC of 1.3 V. The VDDC voltage can be used instead of the VDDD voltage to supply the ARM Cortex-M3 processor, digital peripheral and memories, including the on-chip flash. Note, this power scheme only applies to Run_Slow mode.

VDDA

An on-chip regulator for the analog blocks creates a 2 V voltage (from the battery voltage VDD) for the A/D Converter, PLL and temperature sensor.

VDDO

A dedicated pin sets the logic high voltage for the digital I/O pins. VDDO is typically connected to VDD or VDDD.

Power Supervisor, Power – on Reset, and Brown-Out Protection

The device contains a dedicated hardware power supervisor for monitoring the supply voltages. The power supervisor ensures the device operates deterministically, and without any unexpected behavior during all supply conditions.

The power supervisor releases the internal Power-on Reset (POR) when the supply voltage on VDD exceeds the minimum threshold for proper operation. The release of POR enables the VDDD Digital Supply Regulator. The power supervisor continues to monitor VDD. If VDD drops below the minimum threshold for proper operation the device is reset.

No external circuitry is required for proper device startup. All required start-up delays and reset thresholds are generated on-chip.

In Run_Fast or Run_Slow mode, the power supervisor continually monitors VDDD. If VDDD drops below the minimum threshold for proper operation the device is reset.

The power supervisor is automatically disabled in standby, sleep and shutdown modes to save power.

System Wakeup

Wakeup occurs when the device is switched from standby mode, sleep mode or shutdown mode into any of the run modes. This can be accomplished through one of the wakeup mechanisms. The wakeup controller allows for up to four external events to wake up the system. One dedicated wakeup pin will wake up the system when a Low-to-High transition is detected. Additionally, three DIO pins can be configured for wakeup as well (two DIO pins will trigger a wakeup through a Low-to-High transition, one DIO pin will trigger a wakeup through a High-to-Low transition). The RTC Alarm can also be configured to wake up the system at a predetermined time.

Clocking

The device contains several clock generators and clock I/O capability. After Power-on Reset, the device selects the internal oscillator as the system clock source. The default clock frequency at POR is 10.24 MHz. After boot, the application may select another frequency or switch to another clock source. The device may select the real-time crystal oscillator (32.768 kHz) as the clock source, when low operating frequencies are required to save power.

Internal Oscillator

The device contains a reconfigurable, factory-calibrated internal oscillator. The calibration settings are stored in the on-chip flash. Settings are available for all integer frequencies in the normal operating range (1 MHz to 40 MHz). Finer calibration is possible.

The default setting after Power-on Reset is 10.24 MHz. The application can switch to any operating frequency after entering any of the run modes.

Phase-Locked Loop

The device contains a phase locked loop (PLL). The phase-locked loop is designed to provide ample flexibility to support various use cases where internal or external reference clocks are used to derive the system clock. At start-up the PLL will be free-running and an adequate configuration must be applied before the PLL will function properly. This configuration includes setting a reference clock and an output clock. The PLL must be recalibrated every time the reference clock stops or the PLL unlocks.

Real-Time Clock

The device contains an ultra low-power real-time clock (RTC). The RTC includes a real-time crystal oscillator, read-write RTC counters, and a configurable alarm. The real-time crystal oscillator utilizes a 32.768 kHz external crystal.

The RTC is powered directly from VDD. This allows the RTC to continue to run when the VDDD Digital Supply Regulator voltage is reduced in standby mode or disabled in sleep or shutdown modes and thus the system date and time information are always maintained. The RTC is reset after the initial Power-on Reset but remains operational through a digital reset (watchdog) and operating mode switching.

The alarm function can be configured to wake up the system from standby mode or sleep mode at a pre-determined time. The alarm will also generate an interrupt to the ARM Cortex-M3 processor.

Clock Divisors

On-chip clock divisors and prescalers are available to provide selectable frequencies to the ARM Cortex-M3 processor, sensor interface, peripherals and external interfaces. These divided clocks are derived from the root clock source and may be configured independently. This adjustability allows the optimum clock frequency to be selected for each system component.

ADC

One 12-bit Analog-to-Digital Converter (ADC) with three external, configurable inputs is available. The ADC operates rail-to-rail from 0 V to VDDA (2.0 V) using an internal precision bandgap voltage reference. Two's complement output samples are provided to the ARM Cortex-M3 processor and synchronized to an ADC interrupt. The DMA may also be used to transfer samples directly from the ADC to SRAM.

Temperature Sensor

The device contains a built-in temperature sensor. The temperature sensor works by generating a differential voltage that varies linearly with temperature. The voltage is routed into the ADC resulting in a single-ended output voltage measurable by the ADC.

The temperature sensor is calibrated during factory production by ON Semiconductor. The calibration value is stored in the flash. The device junction temperature may be determined based on the calibration factor and converted ADC output value.

ARM Cortex-M3 Processor

The ARM Cortex-M3 processor is a 32-bit RISC controller specifically designed to meet the needs of advanced, high-performance, low-power applications. The ARM Cortex-M3 processor provides outstanding computational performance and exceptional system response to interrupts while providing small core footprint, industry leading code density enabling smaller memories, reduced pin count and low power consumption.

The ULPMC10 implementation of the ARM Cortex-M3 processor contains all necessary peripherals and bus systems to provide a complete device optimized for battery powered sensor interface applications.

Memories

Flash Memory

512 kB flash is available for storage of application code and data. Flash memory can be written one or more words at a time. Each page must be erased between writes to a flash word. The flash memory can be erased as a set all at once or in individual 2 kB pages. An additional reserved block of flash memory is used to store factory calibration information provided by ON Semiconductor. This block cannot be written by the application. The ARM Cortex-M3 processor executes application code directly from flash with zero wait states when the system clock is lower than 20 MHz. Above 20 MHz wait states are inserted. To avoid wait states the application developer may choose to use the on-chip RAM cache.

SRAM Memory

24 kB of low-power SRAM is available for storage of intermediate data as well as application code. A block of

SRAM can be utilized for caching to avoid wait states at high clock frequencies.

ROM

An on-chip ROM includes boot functionality as well as firmware routines supporting writing to flash in an application.

External Interrupt Controller

Two configurable external interrupt sources may be connected to any two DIO pins on the device. This is in addition to the four possible interrupts for the wakeup controller. Each interrupt may be individually configured for positive edge triggering, negative edge triggering, high level triggering, or low level triggering.

DMA

A flexible DMA unit supports low overhead data exchange between system blocks. Memory-to-Peripheral, Peripheral-to-Memory, and Memory-to-Memory modes are available. Four simultaneous DMA channels can be established with configurable sources and sinks.

The DMA can be used with the UART, SPI, I²C, and PCM interfaces, as well as the ADC.

The DMA operates in the background allowing the ARM Cortex-M3 processor to execute other applications or to reduce its operating frequency to conserve power.

General-Purpose Timers

The device contains two general-purpose timers. Each timer features a 12-bit countdown mode, an external interrupt to the ARM Cortex-M3 processor, a dedicated prescaler, and the ability to poll the counter value. These four general-purpose timers are in addition to the 24-bit SYSTICK timer included as part of the ARM Cortex-M3 processor.

CRC Engine

A 16-bit hardware CRC engine is available. The CRC engine may be used to ensure data integrity of application code and data. The CRC engine's input port and output port are directly accessible from the ARM Cortex-M3 processor. The starting vector may be set to any value. Subsequently, data words of multiple bit lengths can be added to the CRC. The 16-bit CRC-CCITT polynomial is used.

Watchdog Timer

The device contains a digital watchdog timer. The watchdog timer is intended to prevent an indefinite system hang when an application error occurs. The application must periodically refresh the watchdog counter during operation. If a watchdog timeout occurs an initial alert interrupt is generated. If a subsequent watchdog timeout occurs, a system reset is generated. The initial alert may be used to gracefully shut down the system.

ULMPC10

IP Protection

The device contains an optional lock mechanism to prevent access to Flash, memory and registers via the JTAG port. Note, if this feature is enabled the application must implement a “backdoor” in software to regain access to the device. Otherwise, the lock mechanism is irreversible.

Digital I/O (DIO) Interface

All the interfaces available in ULMPC10 for communications with external devices don't have dedicated pins. It is necessary to configure the DIO pads (Digital Input/Outputs) to be able to use them. The only exception is the JTAG interface which has dedicated pads as well as a dedicated SPI port.

By default, all the DIOs are configured as input pins.

In standby, sleep and shutdown modes the DIO configuration is kept if not explicitly disabled by software.

Dual UART

Two general-purpose UART interfaces are available. The UARTs support the standard RS232 protocol and baud rates at the VDDD voltage level. The UART format is fixed at one start bit, eight data bits, and one stop bit. The baud rate is configurable over a wide range of baud rates up to 250 kbaud using a 1 MHz source clock.

The UART interfaces may be used either directly from the ARM Cortex-M3 processor or through the DMA Controller.

Dual SPI

Two SPI interfaces (beyond a dedicated SPI port that is not brought out to pins on the sample package) are available supporting both master and slave operation. Each interface provides a clock, chip select, serial data in, and serial data out connection. The SPI interfaces can be used to interface with external devices such as non-volatile memories, displays, and wireless transceivers. The SPI interfaces can

be used either directly from the ARM Cortex-M3 processor or through the DMA Controller.

I²C

The I²C interface supports both master and slave operation. The interface operates at normal speed (100 kbits/sec) and high speed (400 kbit/sec). On-chip pull-up resistors are available on the SDA and SCL pins.

The I²C interface can be used either directly from the ARM Cortex-M3 processor or through the DMA Controller. The I²C slave address is programmable by the application.

PCM

The pulse-code modulation (PCM) interface provides a data connection between the device and external devices such as Bluetooth or audio processors. The PCM interface can operate both in master and slave mode. The master device of a PCM transfer generates the frame signal.

The PCM interface can be used either directly from the ARM Cortex-M3 processor or through the DMA controller. Two DMA channels are used with the PCM interface – one for RX, and one for TX.

The PCM interface supports a wide variety of interface protocols by reconfiguring the frame type and width, word size and clock polarities. The PCM interface supports the I2S data format directly for connecting to an I2S compatible audio device. Audio data can be streamed to and from the audio device over the PCM interface in I2S mode.

GPIO

Any DIO pin can be configured as GPIO input or output.

Pulse Width Modulators (PWM)

Two, independent pulse width modulators are available on the device. These can be used to drive external actuators or sensors.

ULPMC10

ULPMC10 QFN48 Example Production Package with Stacked Custom ASIC

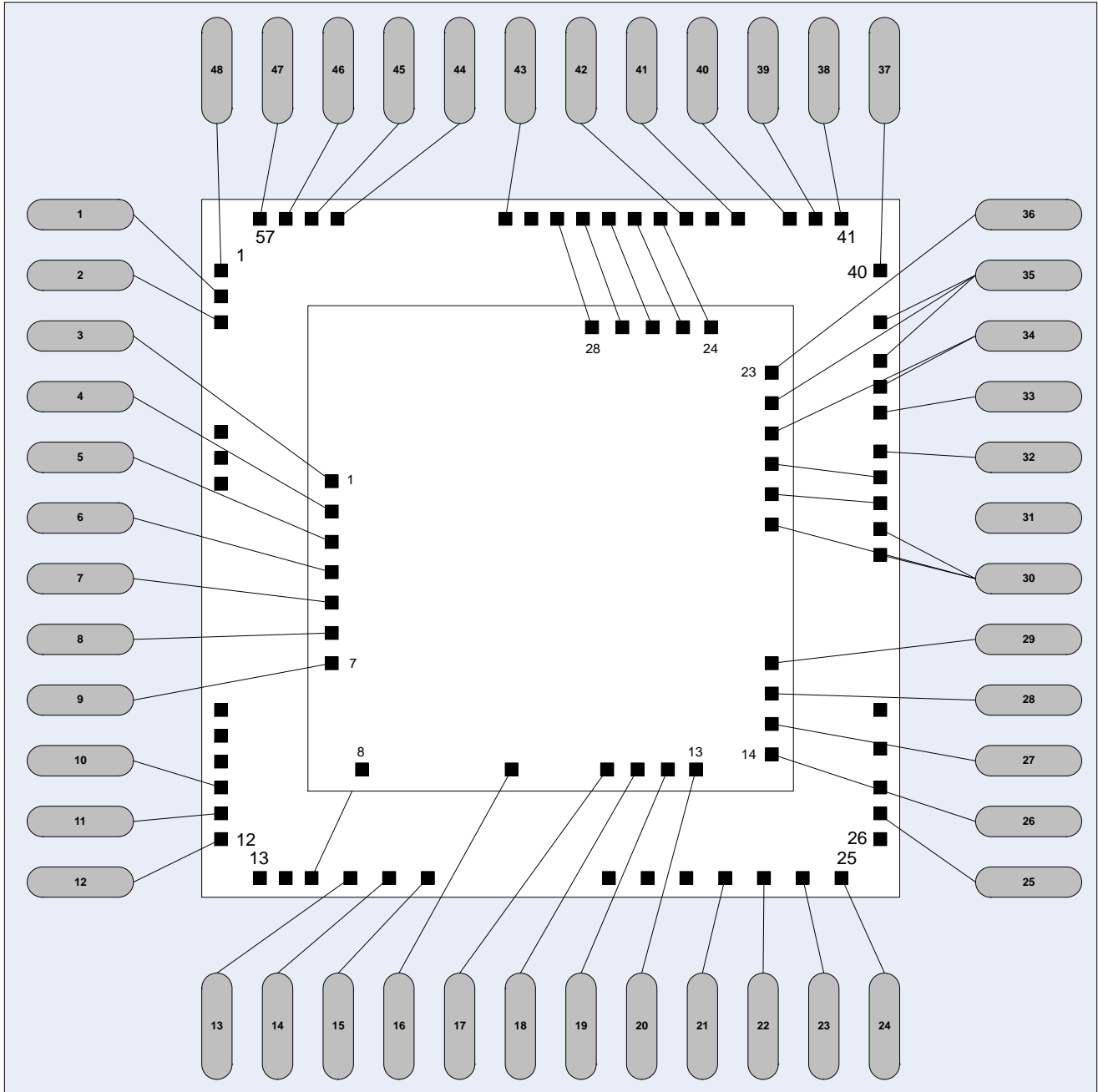

Figure 2. ULPMC10 QFN48 Example Production Package Overview with Stacked Custom ASIC

ULPMC10

ULPMC10 QFN48 Example Production Package Pin with Custom ASIC Overview

Table 1. PIN OUT

Pin#	Pad Name	Description	Domain	I/O	POR Direction	A/D	PU/PD
1	DIO1	Digital Input Output	VDDO	I/O	I	D	PU
2	DIO2	Digital Input Output	VDDO	I/O	I	D	PU
3	CUSTOM	-		-	-	-	-
4	CUSTOM	-		-	-	-	-
5	CUSTOM	-		-	-	-	-
6	CUSTOM	-		-	-	-	-
7	CUSTOM	-		-	-	-	-
8	CUSTOM	-		-	-	-	-
9	CUSTOM	-		-	-	-	-
10	DIO3	Digital Input Output	VDDO	I/O	I	D	PU
11	DIO4	Digital Input Output	VDDO	I/O	I	D	PU
12	DIO5	Digital Input Output	VDDO	I/O	I	D	PU
13	AUX0_DIO27	Digital Input Output configuration LSAD channel 0 configuration	VDD	I/O AI	I	D A	PU
14	AUX1_DIO28	Digital Input Output configuration LSAD channel 1 configuration	VDD	I/O AI	I	D A	PU
15	AUX2	LSAD channel 2 configuration	VDD	AI	I	A	
16	CUSTOM	-		-	-	-	-
17	CUSTOM	-		-	-	-	-
18	CUSTOM	-		-	-	-	-
19	CUSTOM	-		-	-	-	-
20	CUSTOM	-		-	-	-	-
21	VDDA	Analog supply	VDD			A	
22	VSSA	Analog ground	VDD			P	
23	VDDD	Digital core supply	VDD			A	
24	VDD	Power supply 1	VDD			P	
25	VDDC	Power supply 2 / CP output	VDD			A	
26	CUSTOM	-		-	-	-	-
27	CUSTOM	-		-	-	-	-
28	CUSTOM	-		-	-	-	-
29	CUSTOM	-		-	-	-	-
30	RESET	External reset signal	VDD	I	I	D	PD
31	DIO6	Digital Input Output	VDDO	I/O	I	D	PU
32	DIO7	Digital Input Output	VDDO	I/O	I	D	PU
33	VDDO	IO supply	VDDO			A	
34	RESERVED	Tie to VSS	-	-	-	-	-
35	VSSO	IO ground	VDDO			P	
36	CUSTOM	-		-	-	-	-
37	SWDIO	Digital JTAG debug (Data IO)	VDDO	I/O	I	D	PU
38	SWCLK	Digital JTAG debug (Clk)	VDDO	I/O	I	D	PU

ULPMC10

Table 1. PIN OUT

Pin#	Pad Name	Description	Domain	I/O	POR Direction	A/D	PU/PD
39	DIO8	Digital Input Output	VDDO	I/O	I	D	PU
40	DIO9	Digital Input Output	VDDO	I/O	I	D	PU
41	DIO10	Digital Input Output	VDDO	I/O	I	D	PU
42	DIO11	Digital Input Output	VDDO	I/O	I	D	PU
43	DIO12	Digital Input Output	VDDO	I/O	I	D	PU
44	DIO13	Digital Input Output	VDDO	I/O	I	D	PU
45	DIO14	Digital Input Output	VDDO	I/O	I	D	PU
46	DIO15	Digital Input Output	VDDO	I/O	I	D	PU
47	DIO16	Digital Input Output	VDDO	I/O	I	D	PU
48	DIO0	Digital Input Output	VDDO	I/O	I	D	PU

ULPMC10

ULPMC10 QFN48 Sample Package

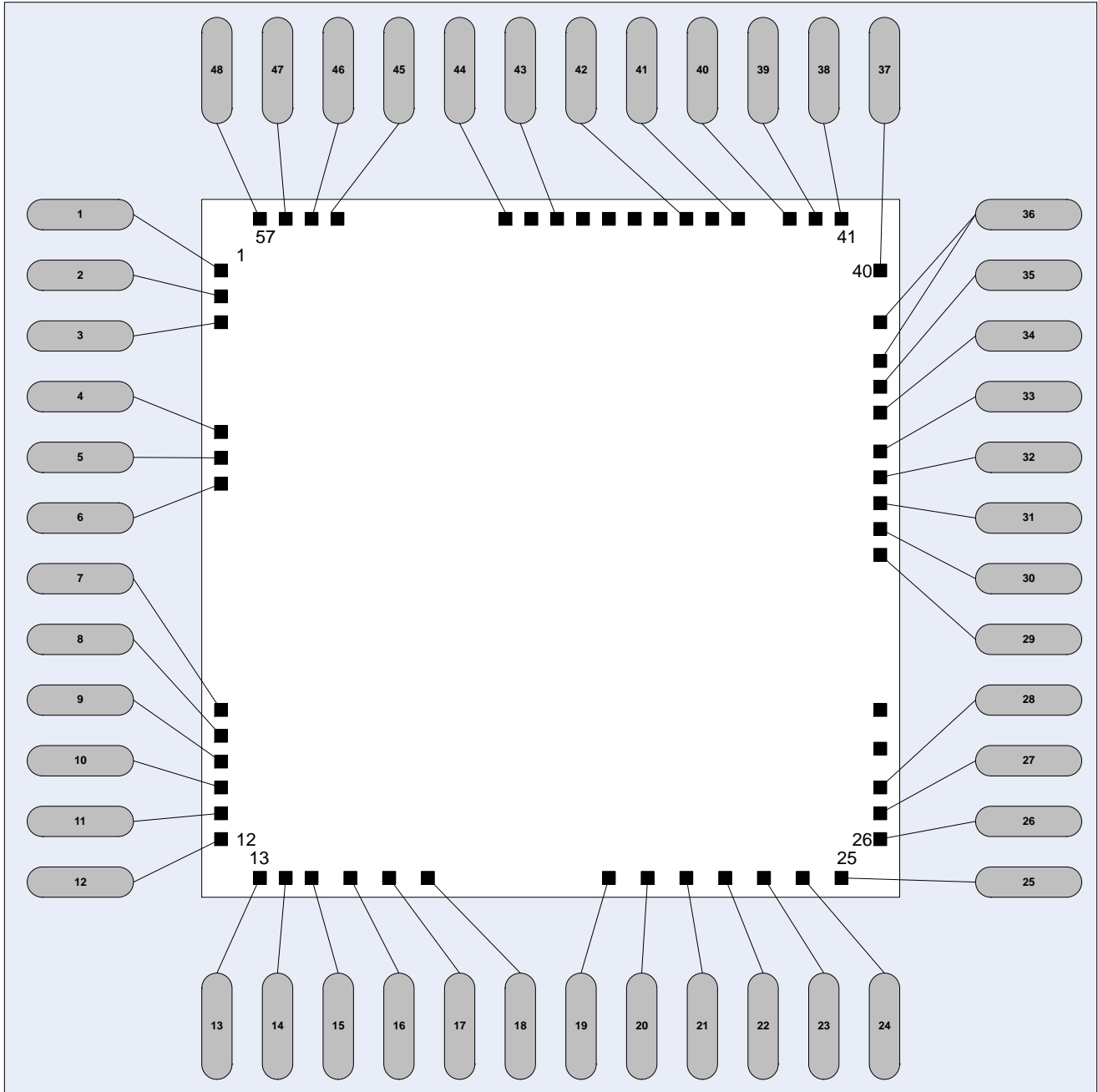

Figure 3. ULPMC10 QFN48 Sample Package

ULPMC10

ULPMC10 QFN48 Sample Package Overview

Table 2. PIN OUT

Pin#	Pad Name	Description	Domain	I/O	POR Direction	A/D	PU/PD
2	DIO1	Digital Input Output	VDDO	I/O	I	D	PU
3	DIO2	Digital Input Output	VDDO	I/O	I	D	PU
10	DIO3	Digital Input Output	VDDO	I/O	I	D	PU
11	DIO4	Digital Input Output	VDDO	I/O	I	D	PU
12	DIO5	Digital Input Output	VDDO	I/O	I	D	PU
16	AUX0_DIO27	Digital Input Output configuration LSAD channel 0 configuration	VDD	I/O AI	I	D A	PU
17	AUX1_DIO28	Digital Input Output configuration LSAD channel 1 configuration	VDD	I/O AI	I	D A	PU
18	AUX2	LSAD channel 2 input	VDD	AI	I	A	PU
22	VDDA	Analog supply	VDD			A	
23	VSSA	Analog ground	VDD			P	
24	VDDD	Digital core supply	VDD			A	
25	VDD	Power supply 1	VDD			P	
27	VDDC	Power supply 2 / CP output	VDD			A	
29	RESET	External reset signal	VDD	I	I	D	PD
32	DIO6	Digital Input Output	VDDO	I/O	I	D	PU
33	DIO7	Digital Input Output	VDDO	I/O	I	D	PU
34	VDDO	IO supply	VDDO			A	
35	EN_TEST	Test enable	VDDO	I	I	D	PD
36	VSSD	Digital ground	VDDO			P	
36	VSSO	IO ground	VDDO			P	
37	SWDIO	Digital JTAG debug (Data IO)	VDDO	I/O	I	D	PU
38	SWCLK	Digital JTAG debug (Clk)	VDDO	I/O	I	D	PU
39	DIO8	Digital Input Output	VDDO	I/O	I	D	PU
40	DIO9	Digital Input Output	VDDO	I/O	I	D	PU
41	DIO10	Digital Input Output	VDDO	I/O	I	D	PU
42	DIO11	Digital Input Output	VDDO	I/O	I	D	PU
44	DIO12	Digital Input Output	VDDO	I/O	I	D	PU
45	DIO13	Digital Input Output	VDDO	I/O	I	D	PU
46	DIO14	Digital Input Output	VDDO	I/O	I	D	PU
47	DIO15	Digital Input Output	VDDO	I/O	I	D	PU
48	DIO16	Digital Input Output	VDDO	I/O	I	D	PU
1	DIO0	Digital Input Output	VDDO	I/O	I	D	PU
30	EXT_CLK	External clock for MMCU	VDD	I/O	I	D	PD
31	WAKEUP	Wakeup Interrupt	VDD	I	I	D	PD
43	DIO17 (CLK_OUT)	Digital Input Output, ADC clock output	VDDO	I/O	O	D	PU
4	DIO18	Digital Input Output	VDDO	I/O	I	D	PU
5	DIO19	Digital Input Output	VDDO	I/O	I	D	PU
6	DIO20	Digital Input Output	VDDO	I/O	I	D	PU

ULPMC10

Table 2. PIN OUT

Pin#	Pad Name	Description	Domain	I/O	POR Direction	A/D	PU/PD
7	DIO21	Digital Input Output	VDDO	I/O	I	D	PU
8	DIO22	Digital Input Output	VDDO	I/O	I	D	PU
9	DIO23	Digital Input Output	VDDO	I/O	I	D	PU
13	DIO24	Digital Input Output	VDDO	I/O	I	D	PU
14	DIO25	Digital Input Output	VDDO	I/O	I	D	PU
15	DIO26	Digital Input Output	VDDO	I/O	I	D	PU
19	VDD_XTAL	XTAL Power supply	VDD			P	
20	XTAL_OUT	External crystal	VDD	AO	O	A	
21	XTAL_IN	External crystal	VDD	AI	I	A	
26	CP2	Charge Pump cap pin 2	VDD			A	
28	CP1	Charge Pump cap pin 1	VDD			A	

Pin Connections

The following table describes the required and recommended external connections and components. These

connections and components are required to ensure proper device operation and performance.

Table 3. REQUIRED AND RECOMMENDED EXTERNAL CONNECTIONS AND COMPONENTS

Comp	Function	Typ. Value	Tolerance
Cap (VDD–VSS)	VDD decoupling	4.7 μ F	\pm 20%
Cap (VDDO–VSS)	VDDO decoupling	4.7 μ F	\pm 20%
Cap (VDDD–VSS)	VDDD decoupling	4.7 μ F	\pm 20%
Cap (VDDC–VSS)	VDDC decoupling	1 μ F	\pm 20%
Cap (VDDA–VSSA)	VDDA decoupling	2.2 μ F	\pm 20%
Cap (CMP1–CMP2)	Charge pump cap	1 μ F	\pm 20%
Cap (VDD_XTAL–VSS)	VDD_XTAL decoupling	1 μ F	\pm 20%
Res (VDD_XTAL–VDD)	VDD_XTAL RC filtering	1 μ F	\pm 20%
XTAL	XTAL oscillator	32.768 kHz	

Table 4. ABSOLUTE MAXIMUM RATINGS

Parameter	Symbol	Min	Max	Units
Input Voltage on any Digital Pin		–0.3	3.8	V
Input Voltage on any Analog Pin		–0.3	3.8	V
Input Voltage on any Supply Pin		–0.3	3.8	V
Current on any Digital Pin			\pm 5	mA
Current on any Analog Pin			\pm 10	mA

Stresses exceeding those listed in the Maximum Ratings table may damage the device. If any of these limits are exceeded, device functionality should not be assumed, damage may occur and reliability may be affected.

ULPMC10

Table 5. RECOMMENDED OPERATING CONDITIONS

Parameter	Symbol	Min	Typ	Max	Units
Power Supply Applied to VDD (Note 1)	VDD	1.8	3.3	3.5	V
Internal Oscillator Clock Frequency		1		20	MHz
Externally–Supplied Clock Frequency				40	MHz
Ambient Operating Temperature Range	Ta	–40		85	°C
Junction Temperature Range	Tj			75	°C

Functional operation above the stresses listed in the Recommended Operating Ranges is not implied. Extended exposure to stresses beyond the Recommended Operating Ranges limits may affect device reliability.

1. Operation with Flash Read to down 1.3 V supported. For Flash Write a minimum VDD of 1.8 V required.

Table 6. ESD AND LATCH–UP CHARACTERISTICS

Parameter	Conditions	Max	Units
ESD – Human Body Model	JEDEC JS – 001 – 2010, all pins	2000	V
ESD – Charged Device Model	JESD22 – C101 – E, all pins	750	V
ESD – Machine Model	JESE22 – A115 – C, all pins	250	V
Latch – Up	JEDEC STD – 78, all pins	± 100	mA

ELECTRICAL CHARACTERISTICS

Typical Values

Unless otherwise noted, Typ values specify the typical values based on design and characterization data under normal operating conditions. Normal operating conditions include a supply voltage (VDD) of 3.3 V and an operating temperature of 25°C. For specific blocks, the details of the normal operation conditions are described in their respective sections.

Minimum and Maximum Values

Unless otherwise noted, Min and Max values specify the designed range or measurement range and are guaranteed by design and/or characterization.

Min and Max values specified may be based on factory production test limits, design, or characterization data.

Normal Operating Conditions

Unless otherwise noted, normal operating conditions indicate an ambient temperature $T_a = 25^\circ\text{C}$ and a supply voltage $V_{DD} = 3.3\text{ V}$. VDDD and VDDA and the Internal Oscillator (PLL) are calibrated to their preset factory calibration settings and correspond to their respective Typ values. VDDO are powered externally from the VDDD Digital Supply Regulator. No external loads are applied to digital I/O or analog pins.

ULPMC10

Table 7. SYSTEM DC ELECTRICAL CHARACTERISTICS

(Typical operating conditions (Ta = 25°C, VDD = 3.3 V, VDDO = VDDD = 1.8 V, 16-bit/32-bit mixed instructions, 66% execution from flash memory, data access from SRAM, peripherals disabled) unless otherwise noted)

Parameter		Symbol	Conditions	Min	Typ	Max	Units
Main Supply Voltage Range		VDD		1.3	1.8	3.6	V
Run Mode Current	Run_Fast Mode Current	IDD	Typical application, read from flash, analog disabled	1 MHz		0.4	mA
				2 MHz		0.8	
				5 MHz		2	
				10 MHz		4	
				20 MHz		8	
			Typical application, execution from SRAM	1 MHz		0.3	
				2 MHz		0.6	
				5 MHz		1.5	
				10 MHz		3	
				20 MHz		6	
Run_Slow Mode Current (Note 2)	IDD	Typical application, read from flash, analog disabled	1 MHz (VDDD = 1.3 V)		0.2	mA	
			5 MHz (VDDD = 1.3 V)		1		
Deep Standby Mode Current		IDD			0.5		μA
Sleep Mode Current		IDD			0.2		μA
Shutdown Mode Current		IDD			0.05		μA

2. VDDD = VDDC = 1.3 V when in Run_Slow Mode.

Table 8. DIGITAL I/O PINS (DIO, SPI, SWD) DC ELECTRICAL CHARACTERISTICS

(Typical operating conditions (Ta = 25°C, VDDO = VDDD, Pull-up/Pull-down Enabled) unless otherwise noted)

Parameter	Symbol	Conditions	Min	Typ	Max	Units
VDDO Supply Voltage Range	VDDO		1.8		3.6	V
Output Low Level	V _{ol}	I _{ol} = 4 mA			0.2 x VDDO	V
Output High Level	V _{oh}	I _{oh} = -4 mA	0.8 x VDDO			V
Input Low Level	V _{il}				0.2 x VDDO	V
Input High Level	V _{ih}		0.8 x VDDO			V
Pull – Up Resistance	R _{pu}	Non-I ² C	VDDO = 1.8 V	10	250	kΩ
			VDDO = 3.3 V	10	250	
		I ² C	VDDO = 1.8 V	10	250	
			VDDO = 3.3 V	10	250	
Pull – Down Resistance	R _{pd}	VDDO = 1.8 V		250		kΩ
		VDDO = 3.3 V		250		
Pin Capacitance	C _{pd}			5		pF
Maximum Output Current	I _{ol} , I _{oh}				± 4	mA
Input Leakage Current	I _l				± 1	μA

ULPMC10

Table 9. WAKEUP, EXTCLK, RESET I/O PINS DC ELECTRICAL CHARACTERISTICS

(Typical operating conditions (Ta = 25°C, Pull – up / Pull – down Enabled, GPIO mode) unless otherwise noted)

Parameter	Symbol	Conditions	Min	Typ	Max	Units
WAKEUP, EXTCLK, RESET Supply Voltage Range	VDD		1.8		3.6	V
Output Low Level	V _{ol}	I _{ol} = 4 mA			0.2 x VDD	V
Output High Level	V _{oh}	I _{oh} = –4 mA	0.8 x VDD			V
Input Low Level	V _{il}				0.2 x VDD	V
Input High Level	V _{ih}		0.8 x VDD			V
Pull – Up Resistance	R _{pu}	VDD = 1.8V		10	250	kΩ
		VDD = 3.3 V		10	250	
Pull – Down Resistance	R _{pd}	VDD = 1.8V		250		kΩ
		VDD = 3.3 V		250		
Pin Capacitance	C _p			5		pF
Maximum Current					± 4	mA

Table 10. FLASH MEMORY DC ELECTRICAL CHARACTERISTICS

(Typical operating conditions (Ta = 25°C) unless otherwise noted. All parameters in this section are obtained through qualification and characterization and are not tested in production)

Parameter	Symbol	Conditions	Min	Typ	Max	Units
Supply Voltage	VDDD	Flash Read Only	1.3	1.8	1.98	V
		Flash Write	1.62	1.8	1.98	
Write Endurance			20000			cycles
Data Retention			100			years
Programming Time (per word)				20		μs
Erase Time		Single page	20			ms
		Entire array	20			

Table 11. LF RC OSCILLATOR DC & AC ELECTRICAL CHARACTERISTICS

(Typical operating conditions (Ta = 25°C) unless otherwise noted)

Parameter	Symbol	Conditions	Min	Typ	Max	Units
Supply Voltage	VDD		1.3		3.6	V
Frequency Range	f			32		kHz
Frequency Accuracy			–50		+50	%

Table 12. 32.768 kHz XTAL CLOCK DC & AC ELECTRICAL CHARACTERISTICS

(Typical operating conditions (Ta = 25°C), unless otherwise noted)

Parameter	Symbol	Conditions	Min	Typ	Max	Units
Supply Voltage	VDD		1.3		3.6	V
Supply Current		CL = 3.5 pF		0.2		μA
Frequency	f			32768		Hz
Duty Cycle				50		%
Startup Time					3	s

ULPMC10

Table 13. PLL DC & AC ELECTRICAL CHARACTERISTICS

(Typical operating conditions (Ta = 25°C) unless otherwise noted)

Parameter	Symbol	Conditions	Min	Typ	Max	Units
Supply Voltage	VDDD		1.1	1.8	1.98	V
	VDDA		1.62	1.8	2	
Reference Clock	f	Non-divided	0.02		65.536	MHz
Reference Clock		Divided	32		512	kHz
Reference Clock Duty Cycle			10		90	%
Output Frequency Range			2		20	MHz
Startup Time					100	μs
Lock Time		Ref Clock of 32.768 kHz			10	ms
Tracking Range		Reference Clock Drift	-2		2	%
VCO Frequency Range		Before Multiplication	2		20	MHz
VCO Frequency Range		After Multiplication	2		80	MHz
VCO Frequency Precision		After Trim	-1		1	%
VCO Frequency Drift		0C-50C	-1.5		1.5	%
VCO Jitter					400	ps
VCO Output Duty Cycle		Multiplier 1x or 2x	45		55	%
		Multiplier 3x	25		75	
		Multiplier 4x	40		60	

Table 14. VDDA REGULATOR DC & AC ELECTRICAL CHARACTERISTICS

(Typical operating conditions (Ta = 25°C), unless otherwise noted)

Parameter	Symbol	Conditions	Min	Typ	Max	Units
Supply Voltage	VDD		2.2		3.6	V
Output Voltage	VDDA	CL = 2.2 μF		2		V
Load Current					4	mA
Load Regulation				5		mV/mA
Line Regulation				20		mV/V
PSRR		@ 1 kHz unloaded	20			dB

Table 15. VDDD REGULATOR DC & AC ELECTRICAL CHARACTERISTICS

(Typical operating conditions (Ta = 25°C), unless otherwise noted)

Parameter	Symbol	Conditions	Min	Typ	Max	Units
Supply Voltage	VDD		1.8		3.6	
Output Voltage	VDDD	After Trim, CL = 4.7 μF	1.3	1.8		V
	VDDD	Standby Mode		1.5		V
Trim Step				20		mV
Load Current					15	mA
Load Regulation					10	mV/mA
Line Regulation					20	mV/V
PSRR			20			dB

ULPMC10

Table 16. VDDC CHARGE PUMP DC & AC ELECTRICAL CHARACTERISTICS

(Typical operating conditions (Ta = 25°C), unless otherwise noted)

Parameter	Symbol	Conditions	Min	Typ	Max	Units
Supply Voltage	VDD		2.6		3.6	V
Output Voltage	VDDC		1.3		1.8	V
Drive Circuit Current				100		nA/kHz
Frequency		Normal Mode	32		500	kHz
		Low Power Mode	1		32	
Load Regulation		VDD > 2.6 V, f = 100 kHz			20	mV/mA
		VDD < 2.6 V, f = 100 kHz			50	
		VDD > 2.6 V, f = 1 kHz			30	
Efficiency			95			%
		f = 1 kHz	75			
Stabilization Time		f = 100 kHz			5	ms
		f = 1 kHz			20	

Table 17. A/D CONVERTER DC & AC ELECTRICAL CHARACTERISTICS

(Typical operating conditions (Ta = 25°C), unless otherwise noted)

Parameter	Symbol	Conditions	Min	Typ	Max	Units
Supply Voltage	VDDA			2		V
Resolution				12		Bits
Input Signal Level			0		2	V
Input Impedance				1		MΩ
Sampling Frequency		f = 128 kHz		0.8		kHz
INL			-4		4	LSB
DNL			-2		2	LSB

Product parametric performance is indicated in the Electrical Characteristics for the listed test conditions, unless otherwise noted. Product performance may not be indicated by the Electrical Characteristics if operated under different conditions.

Electrostatic Discharge (ESD) Device

WARNING: ESD sensitive device. Permanent damage may occur on devices subjected to high-energy electrostatic discharges. Proper ESD precautions in handling, packaging and testing are recommended to avoid performance degradation or loss of functionality.



Packaging Options

The ULPMC10 device is intended for use in stacked packages where the customer purchases a proprietary ASIC from ON, which combines to form a miniature, low-power processing system. ON Semiconductor recommends a QFN48 package for this purpose; however, the exact pin out

requirements from both ULPMC10 and a proprietary ASIC will determine the package used. To allow customers to prototype a stacked package system before actually making this, ULPMC10 is available standalone in a QFN48 sample package.

Ordering Information

To order ULPMC10 QFN48 packages for prototyping or to discuss how to engage with ON Semiconductor in developing a proprietary ASIC to meet specific circuit needs, please contact your ON Semiconductor Sales Representative.

Development Tools

An advanced, easy-to-use tool chain is available from IAR Systems. The tool chain including in-circuit debugging probes are available directly from IAR.

ON Semiconductor markets a miniature development board that connects easily to an in-circuit debugging probe from IAR (see: Figure 4).

ULPMC10



Figure 4. Miniature Development Board

The development board, together with documentation that can be downloaded from ON Semiconductor's website, allows for quick evaluation and application prototyping. To order the development board, please contact your ON Semiconductor Sales Representative.

ULPMC10

PACKAGE DIMENSIONS

QFN48 6x6, 0.4P
CASE 485AN
ISSUE O

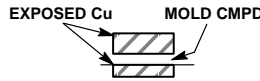
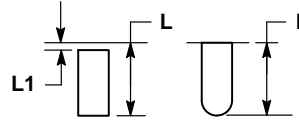
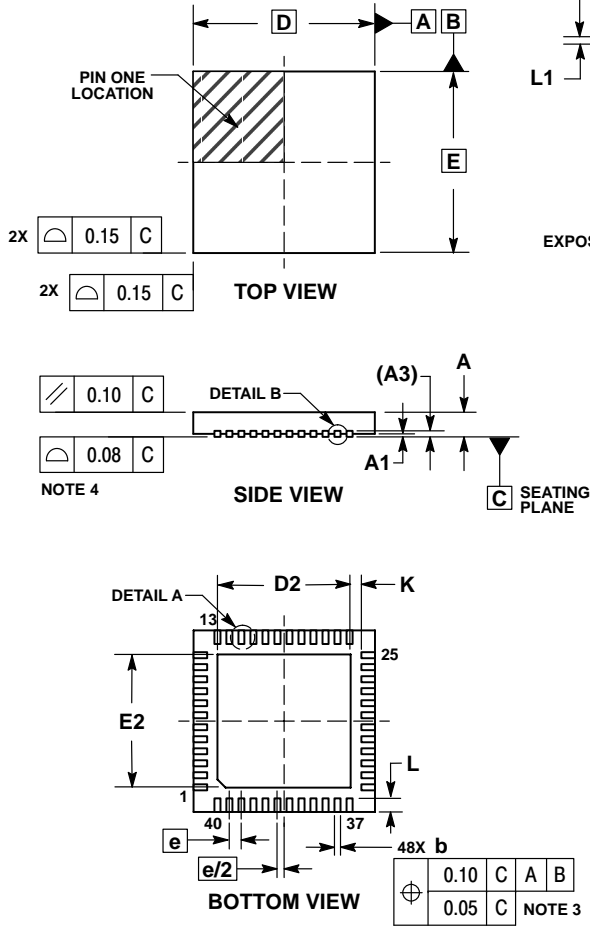

NOTES:

1. DIMENSIONING AND TOLERANCING PER ASME Y14.5M, 1994.
2. CONTROLLING DIMENSIONS: MILLIMETERS.
3. DIMENSION b APPLIES TO PLATED TERMINAL AND IS MEASURED BETWEEN 0.15 AND 0.30mm FROM TERMINAL TIP
4. COPLANARITY APPLIES TO THE EXPOSED PAD AS WELL AS THE TERMINALS.

DIM	MILLIMETERS	
	MIN	MAX
A	0.70	0.80
A1	0.00	0.05
A3	0.20 REF	
b	0.15	0.25
D	6.00 BSC	
D2	4.25	4.55
E	6.00 BSC	
E2	4.25	4.55
e	0.40 BSC	
K	0.20 MIN	
L	0.35	0.55
L1	0.00	0.15

SOLDERING FOOTPRINT*

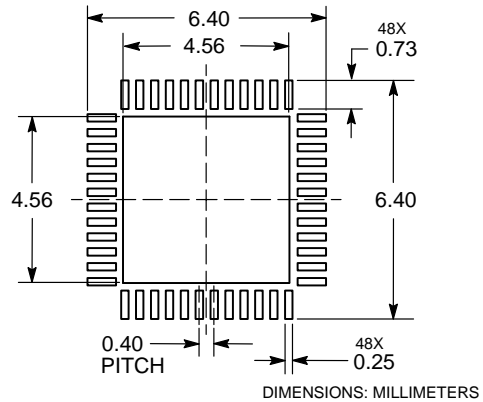

*For additional information on our Pb-Free strategy and soldering details, please download the ON Semiconductor Soldering and Mounting Techniques Reference Manual, SOLDERRM/D.

ARM and Cortex are registered trademarks of ARM Holdings, plc.
Bluetooth is a registered trademark of Bluetooth SIG, Inc.

ON Semiconductor and the are registered trademarks of Semiconductor Components Industries, LLC (SCILLC) or its subsidiaries in the United States and/or other countries. SCILLC owns the rights to a number of patents, trademarks, copyrights, trade secrets, and other intellectual property. A listing of SCILLC's product/patent coverage may be accessed at www.onsemi.com/site/pdf/Patent-Marketing.pdf. SCILLC reserves the right to make changes without further notice to any products herein. SCILLC makes no warranty, representation or guarantee regarding the suitability of its products for any particular purpose, nor does SCILLC assume any liability arising out of the application or use of any product or circuit, and specifically disclaims any and all liability, including without limitation special, consequential or incidental damages. "Typical" parameters which may be provided in SCILLC data sheets and/or specifications can and do vary in different applications and actual performance may vary over time. All operating parameters, including "Typicals" must be validated for each customer application by customer's technical experts. SCILLC does not convey any license under its patent rights nor the rights of others. SCILLC products are not designed, intended, or authorized for use as components in systems intended for surgical implant into the body, or other applications intended to support or sustain life, or for any other application in which the failure of the SCILLC product could create a situation where personal injury or death may occur. Should Buyer purchase or use SCILLC products for any such unintended or unauthorized application, Buyer shall indemnify and hold SCILLC and its officers, employees, subsidiaries, affiliates, and distributors harmless against all claims, costs, damages, and expenses, and reasonable attorney fees arising out of, directly or indirectly, any claim of personal injury or death associated with such unintended or unauthorized use, even if such claim alleges that SCILLC was negligent regarding the design or manufacture of the part. SCILLC is an Equal Opportunity/Affirmative Action Employer. This literature is subject to all applicable copyright laws and is not for resale in any manner.

PUBLICATION ORDERING INFORMATION

LITERATURE FULFILLMENT:
Literature Distribution Center for ON Semiconductor
P.O. Box 5163, Denver, Colorado 80217 USA
Phone: 303-675-2175 or 800-344-3860 Toll Free USA/Canada
Fax: 303-675-2176 or 800-344-3867 Toll Free USA/Canada
Email: orderlit@onsemi.com

N. American Technical Support: 800-282-9855 Toll Free USA/Canada
Europe, Middle East and Africa Technical Support:
Phone: 421 33 790 2910
Japan Customer Focus Center
Phone: 81-3-5817-1050

ON Semiconductor Website: www.onsemi.com
Order Literature: <http://www.onsemi.com/orderlit>
For additional information, please contact your local Sales Representative