

UM-1 and UM-5 Crystals

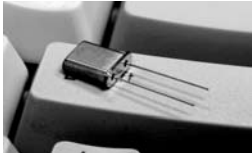

The UM series of miniature resistance weld crystals are suitable for applications where tight specs, small footprint, and wide frequency range is important.

UM-1 00.0000 MHz (customer specified frequency)

UM-1-R 00.0000 MHz (RoHS Compliant and customer specified frequency)

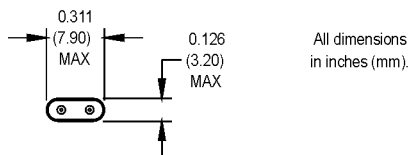
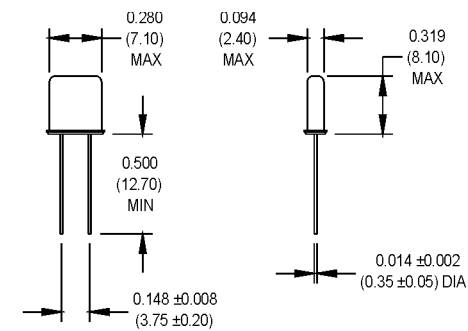

See page 2 for gull wing configuration.

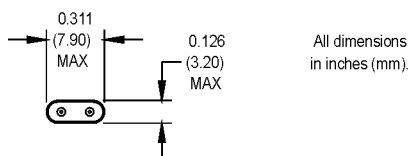
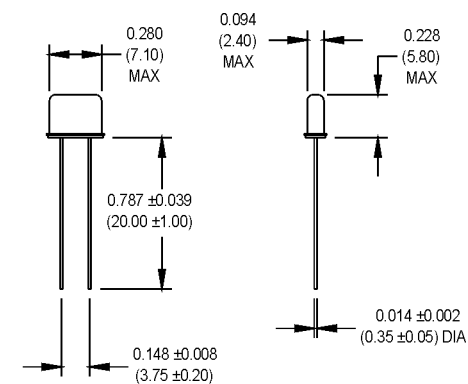

UM-5 00.0000 MHz (customer specified frequency)

UM-5-R 00.0000 MHz (RoHS Compliant and customer specified frequency)

See page 2 for gull wing configuration.

Electrical/Environmental Specifications

PARAMETERS	UM-1/*SRUM-1	UM-5/*SRUM-5
Frequency Range (MHz)	6.000 to 200.000	12.000 to 200.000
Tolerance @ +25°C	±25 ppm	±25 ppm
Stability	±35 ppm	±35 ppm
Aging	±5 ppm/yr. Max.	±5 ppm/yr. Max.
Shunt Capacitance	7 pF Max.	7 pF Max.
Load Capacitance	18 pF Std.	18 pF Std.
Standard Operating Conditions	-20°C to +70°C	-20°C to +70°C
Equivalent Series Resistance (ESR), Max.		
Fundamental (AT-cut)		
6.000 to 7.999 MHz	120 Ω	
8.000 to 9.999 MHz	80 Ω	
10.000 to 17.999 MHz	40 Ω	40 Ω
18.000 to 30.000 MHz	30 Ω	30 Ω
Third Overtones (AT-cut)		
25.000 to 29.999 MHz	50 Ω	50 Ω
30.000 to 75.000 MHz	45 Ω	45 Ω
Fifth Overtones (AT-cut)		
50.000 to 143.000 MHz	90 Ω	90 Ω
Seventh Overtones (AT-cut)		
125.000 to 180.000 MHz	140 Ω	140 Ω
Ninth Overtones (AT-cut)		
180.000 to 200.000 MHz	150 Ω	150 Ω
Drive Level	1 mW Max.	1 mW Max.
Holder	UM-1	UM-5
Mechanical Shock	MIL-STD-202, Method 213, C	
Vibration	MIL-STD-202, Method 201 & 204	
Solder Conditions	See page 147	
Thermal Cycle	MIL-STD-883, Method 1010, B	

* Series resonant designated by "SR" prefix (i.e., SRUM-1).
Contact the factory for specifications not listed.

Gull Wing/Surf Board Configurations

Full Size Standard Gull Wing Oscillator

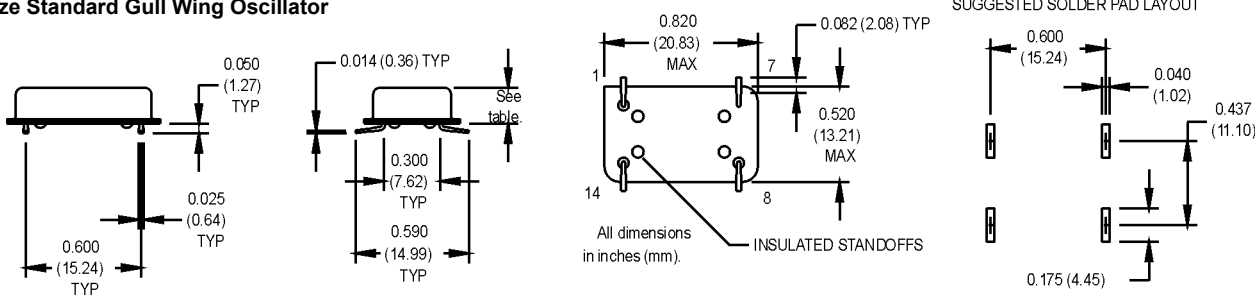

For this dimension please refer to the individual product family datasheet.

Half Size Standard Gull Wing Oscillator

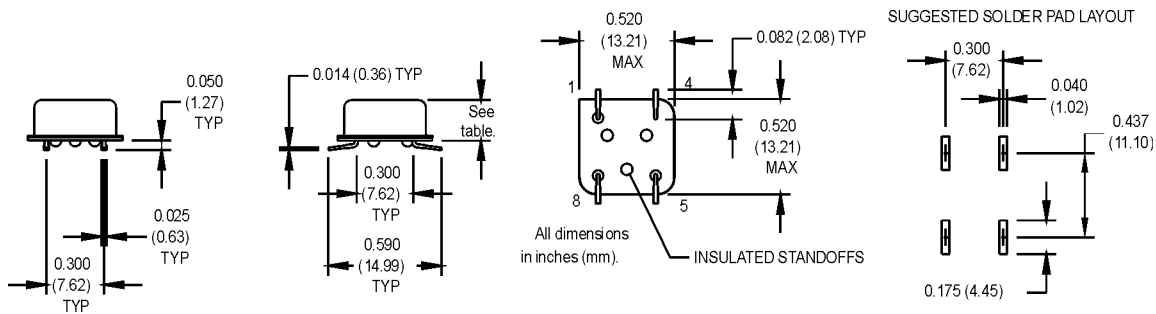

For this dimension please refer to the individual product family datasheet.

MTXO and MTXV Series Standard Surf Board Oscillator

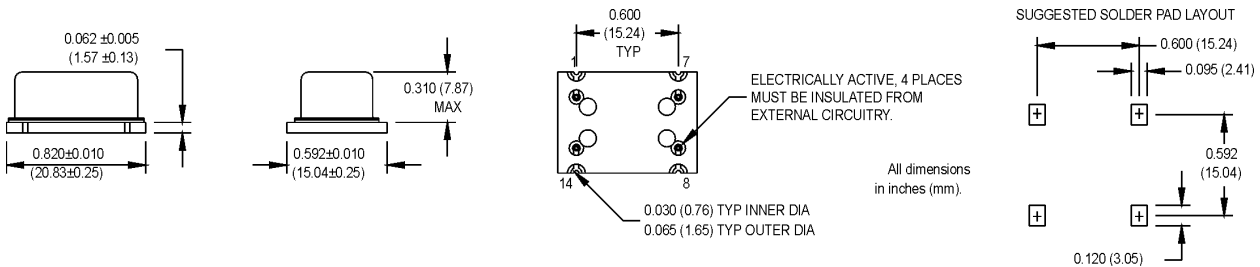

UM-1/G and UM-5/G Standard Gull Wing Crystals

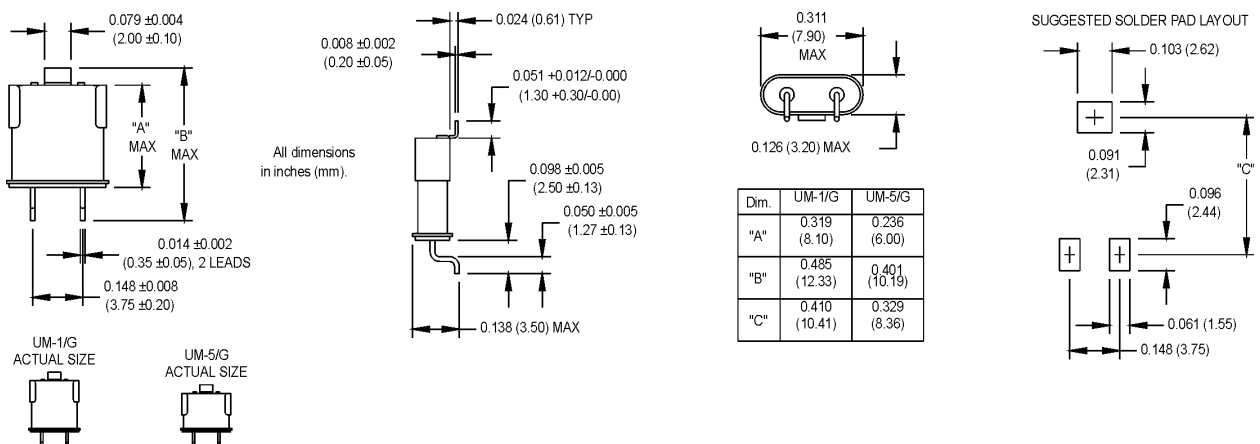

MtronPTI reserves the right to make changes to the product(s) and service(s) described herein without notice. No liability is assumed as a result of their use or application.

Please see www.mtronpti.com for our complete offering and detailed datasheets. Contact us for your application specific requirements: MtronPTI 1-800-762-8800.