

UM1B~UM10B

Rev.C Feb.-2015

描述 / Descriptions

0.8A 表面贴装玻璃钝化整流桥，薄型 UMB 封装。

0.8A Surface Mount Glass Passivated Bridge Rectifier, UMB thin package.

特征 / Features

玻璃钝化芯片，浪涌电流大，反向电压：100V~1000V，正向电流：0.8A，适用表面贴装。无卤产品。

Glass Passivated Chip Junction, High Surge Current Capability, Reverse Voltage :100 to 1000V,

Forward Current: 0.8A, Designed for Surface Mount Application. Halogen free product.

用途 / Applications

一般用途。

General purpose.

内部等效电路 / Equivalent Circuit

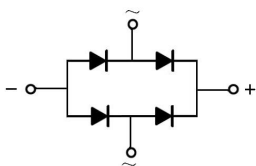

引脚排列 / Pinning

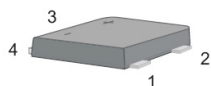

PIN	DESCRIPTION
1	Input Pin (~)
2	Input Pin (~)
3	Output Anode (+)
4	Output Cathode (-)

印章代码 / Marking

见印章说明。See Marking Instructions.

极限参数 / Absolute Maximum Ratings(Ta=25°C)

参数 Parameter	符号 Symbol	数值 Rating						单位 Unit
		UM1B	UM2B	UM4B	UM6B	UM8B	UM10B	
Maximum Repetitive Peak Reverse Voltage	V_{RRM}	100	200	400	600	800	1000	V
Maximum RMS voltage	V_{RMS}	70	140	280	420	560	700	V
Maximum DC Blocking Voltage	V_{DC}	100	200	400	600	800	1000	V
Average Rectified Output Current at Ta = 40°C	I_o	0.8						A
Peak Forward Surge Current 8.3 ms Single Half Sine Wave Superimposed on Rated Load (JEDEC Method)	I_{FSM}	25						A
Typical Junction Capacitance ^(Note1)	C_i	13						pF
Typical Thermal Resistance ^(Note2)	$R_{\theta JA}$	180						°C/W
Operating and Storage Temperature Range	T_j, T_{stg}	-55~150						°C

Note:

1. Measured at 1MHz and applied reverse voltage of 4 V D.C.
2. P.C.B. mounted with 4x0.1x0.1"(4x2.54x2.54mm) copper pad areas.

电性能参数 / Electrical Characteristics(Ta=25°C)

参数 Parameter	符号 Symbol	测试条件 Test Conditions	数值 Rating	单位 Unit
Forward Voltage per element	V_F	$I_F=0.4A$	1.0	V
		$I_F=0.8A$	1.1	
Maximum DC Reverse Current at Maximum DC Blocking Voltage	I_R	$T_a=25^\circ C$	5.0	μA
		$T_a=125^\circ C$	100	

电参数曲线图 / Electrical Characteristic Curve

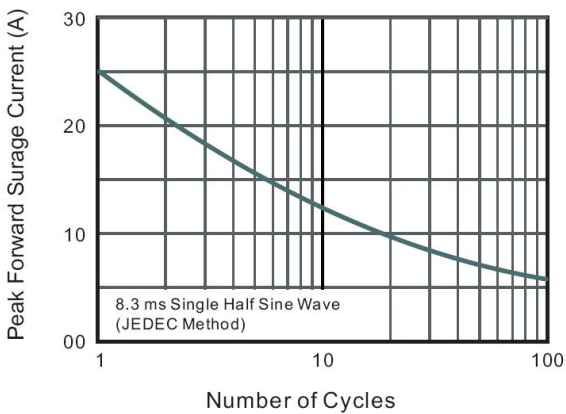
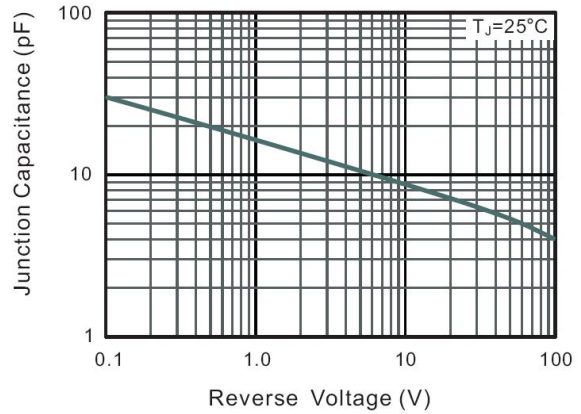
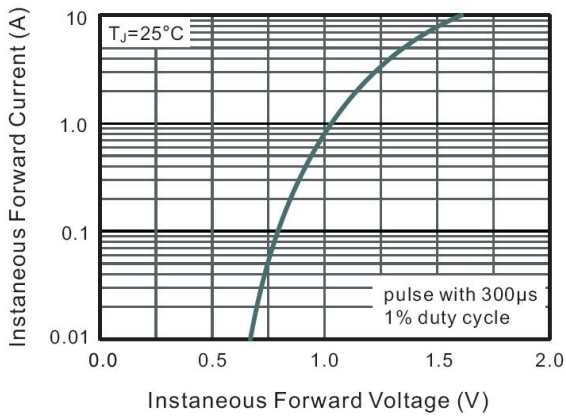
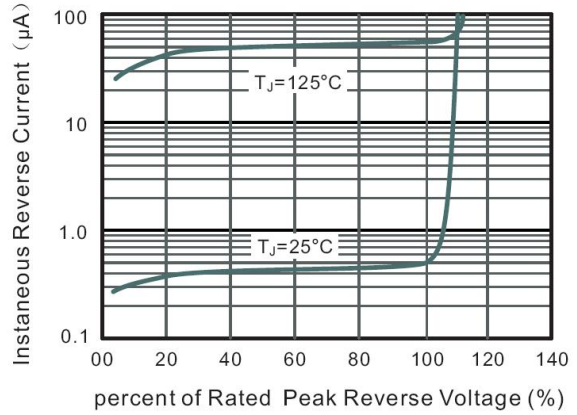
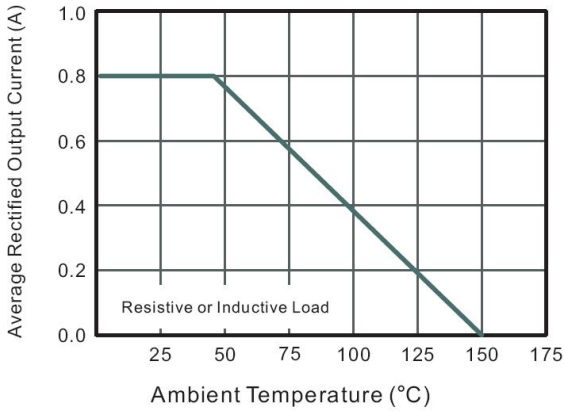

外形尺寸图 / Package Dimensions

UMB

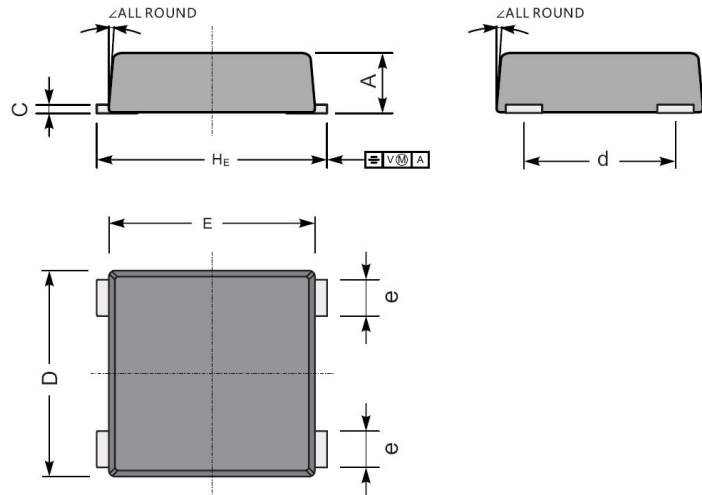

UMB mechanical data

UNIT		A	C	D	E	He	d	e	∠
mm	max	1.2	0.19	3.7	4.0	5.0	2.7	0.7	7°
	min	1.0	0.12	3.4	3.6	4.6	2.3	0.5	
mil	max	47	7.5	146	158	197	106	28	
	min	40	4.7	134	142	181	91	20	

Marking

Type number	Marking code
UM1B	UM1B
UM2B	UM2B
UM4B	UM4B
UM6B	UM6B
UM8B	UM8B
UM10B	UM10B

回流焊温度曲线图(无铅) / Temperature Profile for IR Reflow Soldering(Pb-Free)

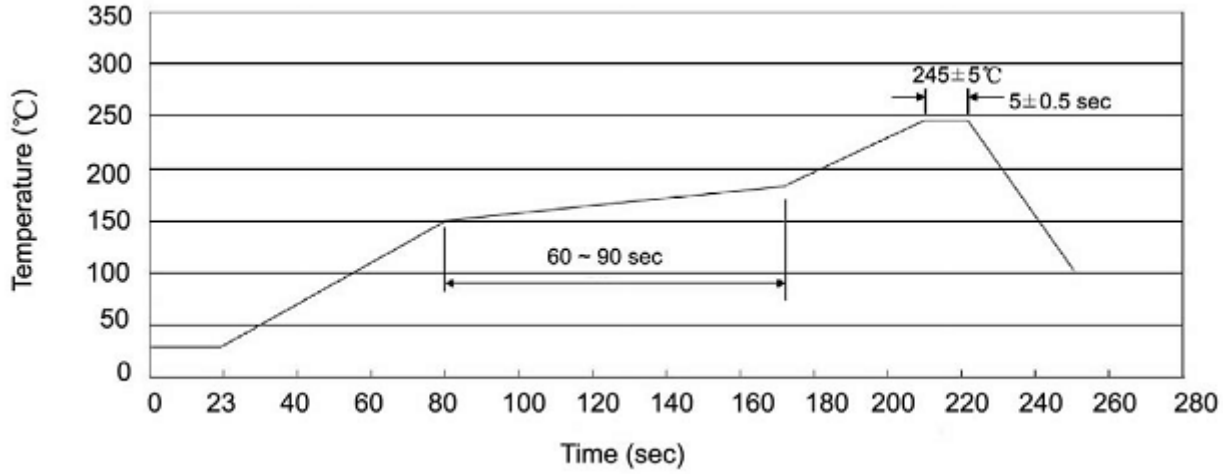

说明：

- 1、预热温度 25 ~ 150°C，时间 60 ~ 90sec;
- 2、峰值温度 245±5°C，时间持续为 5±0.5sec;
- 3、焊接制程冷却速度为 2 ~ 10°C/sec.

Note:

- 1.Preheating:25~150°C, Time:60~90sec.
- 2.Peak Temp.:245±5°C, Duration:5±0.5sec.
3. Cooling Speed: 2~10°C/sec.

耐焊接热试验条件 / Resistance to Soldering Heat Test Conditions

温度：260±5°C

时间：10±1 sec.

Temp.:260±5°C

Time:10±1 sec

包装规格 / Packaging SPEC.

卷盘包装 / REEL

Package Type 封装形式	Units 包装数量					Dimension 包装尺寸 (unit: mm ³)		
	Units/Reel 只/卷盘	Reels/Inner Box 卷盘/盒	Units/Inner Box 只/盒	Inner Boxes/Outer Box 盒/箱	Units/Outer Box 只/箱	Reel	Inner Box 盒	Outer Box 箱

使用说明 / Notices