

Ultrasonic proximity sensors UM30, UM18 and UC12 – powerful devices for almost any application.

Even when it's extremely dusty: The ultrasonic proximity sensors are not impaired by foreign bodies in the air, mist, vapour and dirt. Even the background suppression is near perfect. We call this concentrating on the essentials.

UM 30



Far and near – different scanning ranges

Short, medium or long-distance? The UM30 has three different scanning ranges. The minimum operating distance begins at a minute 30 mm, and for really long-distance applications, to the limit of the scanning range is astonishing 6000 mm.

Detection or measurement as required

The UM30 can be fitted with a binary output or analogue interface. Depending on the task on hand, objects can simply be detected or their distance measured.

UM 18



Smaller diameter with the same functionality

The UM18 has 1 or 2 switching outputs and extended features (for instance, ObSB mode): The sensor is taught a fixed background and reliably switches when an object is detected between sensor and background: Perfect for detecting round or tilted surfaces!

Typical applications

- Level control of solids and liquids
- Checking presence of outer packaging
- Assignment control during packaging
- Checking presence of PET bottles
- Diameter control
- Loop control

Typical applications

- Positioning of small objects in tight environments
- Checking for the presence of small, transparent or opaque outer packaging

Mode of operation: detecting, measuring and switching with ultrasonic proximity sensors.

The detection of objects with ultrasonic sensors opens up a new dimension. Objects are positioned, detected and controlled virtually irrespective of material and environment.

Sensors with a profile – defining the detection area

SICK Ultrasonic Sensors generate an ultrasonic wave by means of a piezo element in the front part of the housing. The wave spreads in the atmosphere in accordance with the laws of physics. The same piezo element can detect and measure the sound reflected by an object. Therefore it functions alternately as sender and receiver (transceiver).

The measurement principle of ultrasonic sensors is based on the time taken for ultrasonic to travel through the medium air. The signals are transmitted in defined “packages”.

With the help of its processing electronics, the transceiver evaluates the time taken between the transmission of a sound “package” and the arrival of the reflection from an object. As a result, either a signal proportionate to the distance is sent via an analogue interface, or a switching signal depending on a previously set distance parameter is sent through a binary output. The accuracy of the measurement and the maximum scanning range lie within a tolerance range which depends mainly on the state of the carrier medium air and the roughness of the object in question.

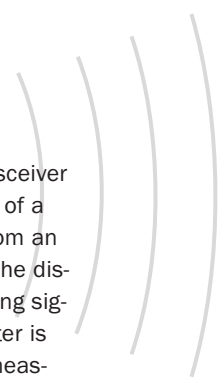

Positioning

Object detection and distance measurement independent of material

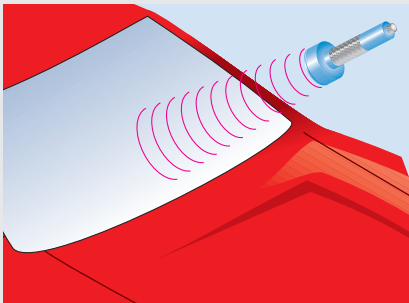

Detection

Recognise transparent objects

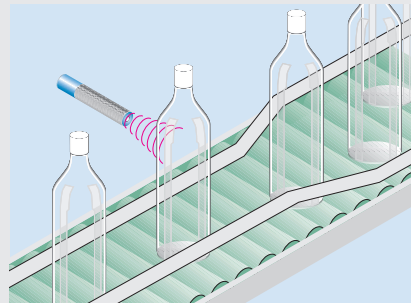

Unwind

Distance measurement for diameter check

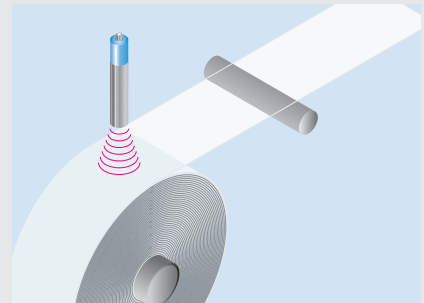

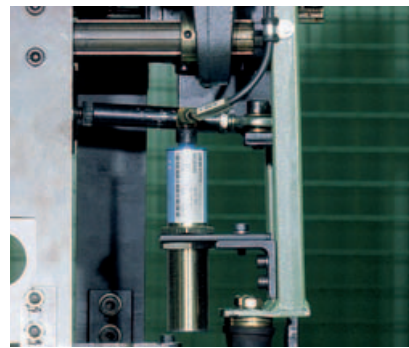
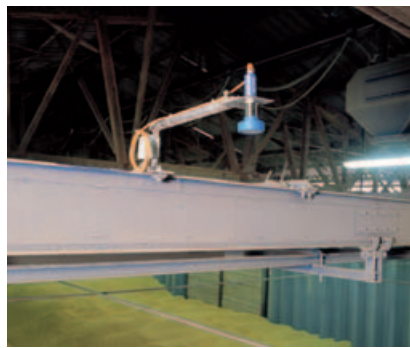

Sensors in action – scanning and measuring reflections

Ultrasonic sensors UM30 are used as non-contact proximity switches which process reflected signals, e.g. from objects on a conveyor belt. An essential benefit of the working principle of ultrasonic sensors is the almost complete blanking of the background, a prerequisite for accurate detection.

Scanning round corners – thanks to the right accessories

Ultrasonic sensors UM30 are small and easily installed even in confined spaces. And if things get really tight, the right accessories can help out. Suitable reflectors allow sound to be deflected almost without loss.

Package

“Engaged” check on package content

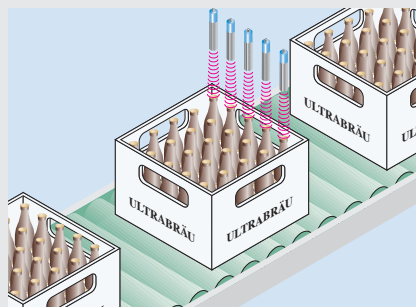

Adjust

Control material looping

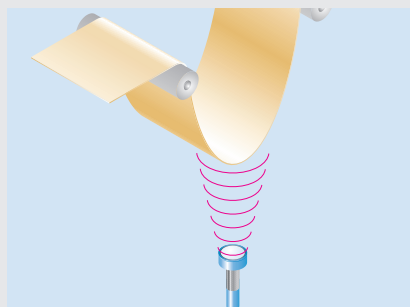

Monitoring

Level control in silos and containers

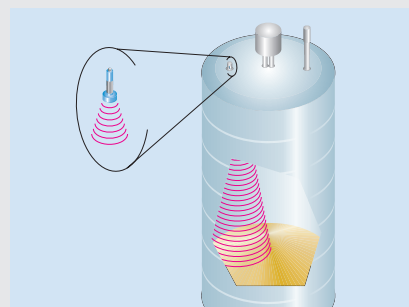

Detection range and assembly of ultrasonic sensors.

Detection range

To determine the area of detection of the sensors, a series of measurements are carried out with two standardised objects, a thin round rod and a plate. The three-dimensional area within which the sensor responds to the rod has the form of a thin club. It marks the typical operating scanning range of the sensor.

The sensor responds to the plate within the area of a larger beam. This area defines the maximum or limit detection range of the sensor.

When projected onto a two-dimensional grid, typical profiles are created. These are the operating diagrams of the ultrasonic sensors, from which the operating scanning range, the limiting scanning range, the specific shape and the blind zone of the detection range can be read off. Objects which are smaller than the round rod may only be detected within an area smaller than the operating scanning range.

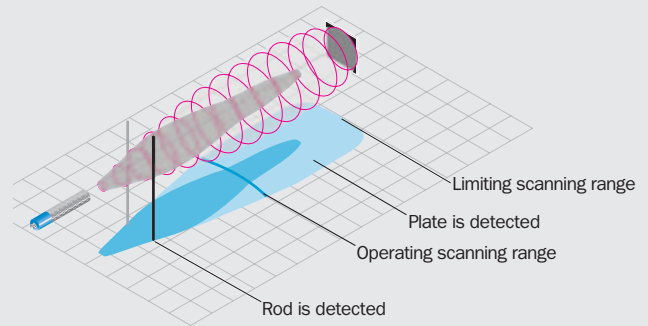

Every ultrasonic sensor has its characteristic club-shaped detection range. It is narrow for smaller objects and wide for larger ones. The typical detection areas are depicted by sound-beam diagrams.

Installation

Ultrasonic sensors installed close together or opposite one another may affect each other mutually. For this reason, different axial and lateral distances have to be maintained depending on the detection range. The sensor with the largest detection range determines the minimum distance.

Operating scanning range	Min. installation distance A	Min. installation distance B
0.25 m	10 cm	> 100 cm
0.35 m	> 30 cm	> 170 cm
1.3 m	> 60 cm	> 540 cm
3.4 m	> 160 cm	> 1600 cm
6 m	> 260 cm	> 3000 cm

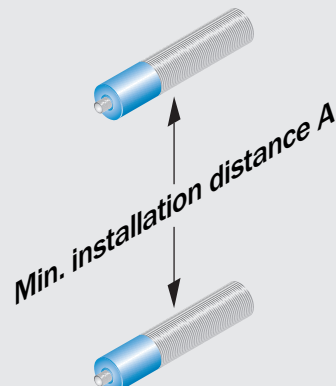
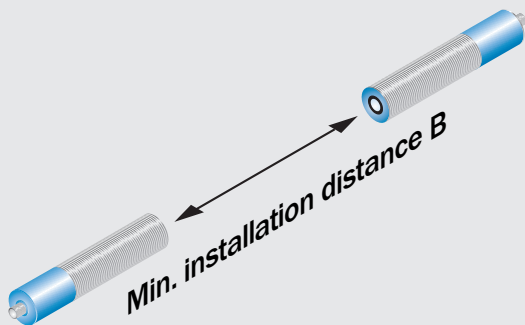

Operating scanning range
30 ... 1300 mm

Ultrasonic sensor

- Independent of material shape (including films, glass and bottles)
- Teach-in
- Insensitive to dirt, dust and fog
- Operating scanning range up to 1300 mm
- Binary outputs or analogue output

Dimensional drawing

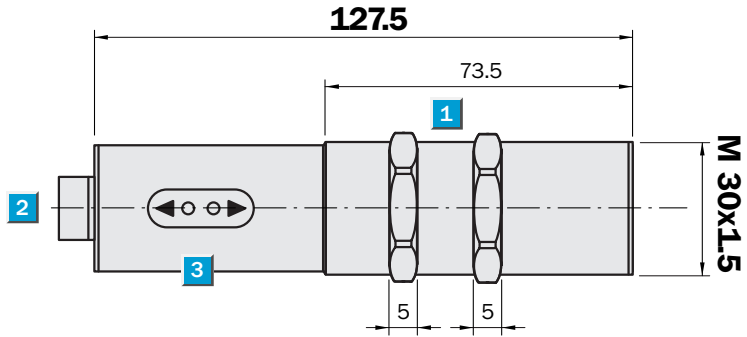

Adjustments possible

All types

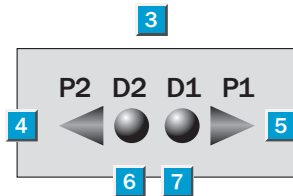

- 1 Fastening nuts, width across 36 mm
- 2 Connection plug M12
- 3 Control and display panel
- 4 Setting key 2
- 5 Setting key 1
- 6 LED 2
- 7 LED 1



Connection types

UM30-11111	UM30-11112	UM30-11113
UM30-12111	UM30-12112	UM30-12113
UM30-13111	UM30-13112	UM30-13113

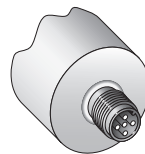
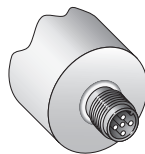
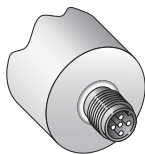

5-pin, M12

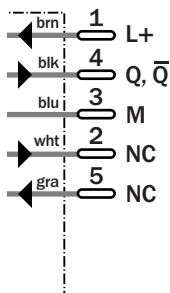

5-pin, M12

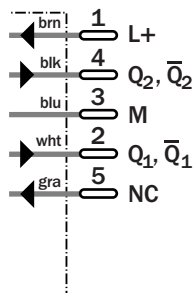

5-pin, M12

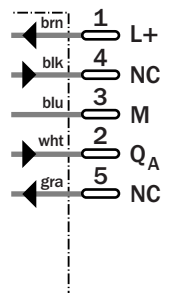

Accessories

Mounting systems

Technical data		UM30-	11111	11112	11113	12111	12112	12113	13111	13112	13113
Operating scanning range	30 ... 250 mm (350)										
(limiting scanning range)	60 ... 350 mm (600)										
	200 ... 1300 mm (2000)										
Ultrasonic frequency	320 kHz										
	400 kHz										
	200 kHz										
Resolution	0.36 mm										
Reproducibility	± 0.15 % of final value										
Accuracy	≤ 2 % of final value										
Supply voltage V_s	9 ... 30 V DC ¹⁾										
Residual ripple	± 10 %										
Current consumption ²⁾	≤ 60 mA										
Switching outputs, reversible ³⁾	Q: PNP										
	Q_1, Q_2 : 2 x PNP										
Analogue output, reversible ^{3) 4)}	Q_A : 4 ... 20 mA/0 ... 10 V										
Response time	50 ms										
	70 ms										
	110 ms										
Switching frequency	11/s										
	8/s										
	6/s										
Switching hysteresis	20 mm										
	5 mm										
	2.5 mm										
Standby delay	2 s										
Connection type	Plug M12, 5-pin										
Enclosure rating	IP 65										
Ambient temperature	Operation -20 °C ... +70 °C										
	Storage -40 °C ... +85 °C										
Weight	260 g										
Housing material	Nickel-plated brass										

¹⁾ Limit values
²⁾ Without load
³⁾ Outputs short-circuit protected
 $I_{max} = 200 \text{ mA}$
 PNP: High = $V_s - (< 2 \text{ V})$ / LOW = 0 V

⁴⁾ Automatic switching between voltage and current outputs dependent on load

Current output 4 ... 20 mA:
 $R_L \leq 500 \Omega, V_s \geq 20 \text{ V};$
 $R_L \leq 100 \Omega, V_s \geq 12 \text{ V}$
 Voltage output 0 ... 10 V:
 $R_L \geq 100 \text{ k}\Omega; V_s > 15 \text{ V}$

⁵⁾ Temperature compensation at -20 ... +65 °C
⁶⁾ Plastic parts: PBT
 Ultrasonic transducer: Polyurethane-foam, glass epoxy resin

Detection ranges

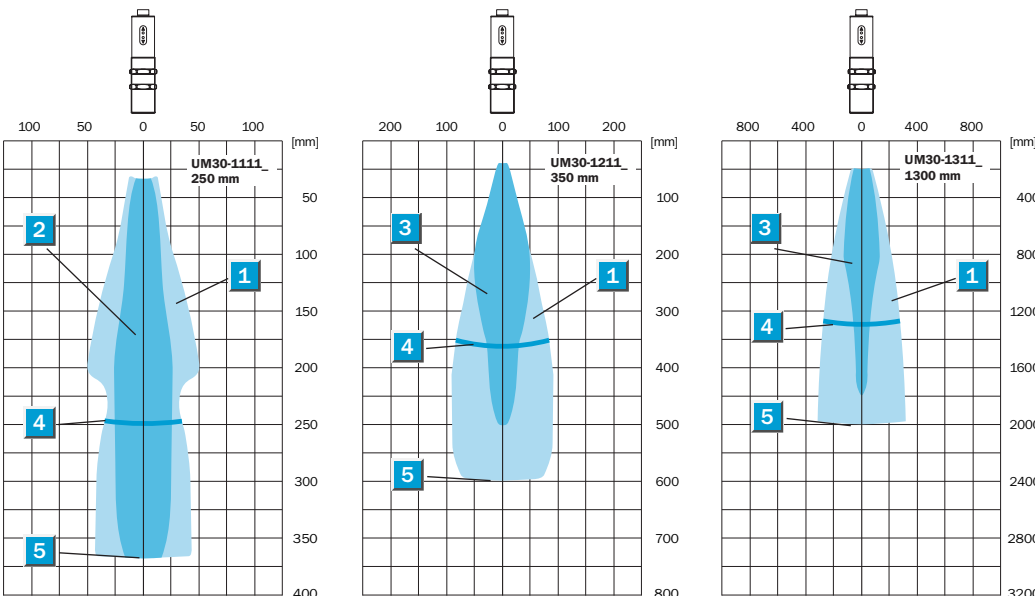

1	Aligned plate 500 x 500 mm
2	Pipe diameter 10 mm
3	Pipe diameter 27 mm

4	Operating scanning range
5	Limiting scanning range

Order information

Type	Order no.
UM30-11111	6025655
UM30-12111	6025656
UM30-13111	6025657
UM30-11112	6025660
UM30-12112	6025661
UM30-13112	6025662
UM30-11113	6025665
UM30-12113	6025666
UM30-13113	6025667

Operating scanning range
30 ... 1300 mm

Ultrasonic sensor

- Independent of material shape (including films, glass and bottles)
- Teach-in
- Insensitive to dirt, dust and fog
- Operating scanning range up to 1300 mm
- Binary outputs or analogue output

Dimensional drawing

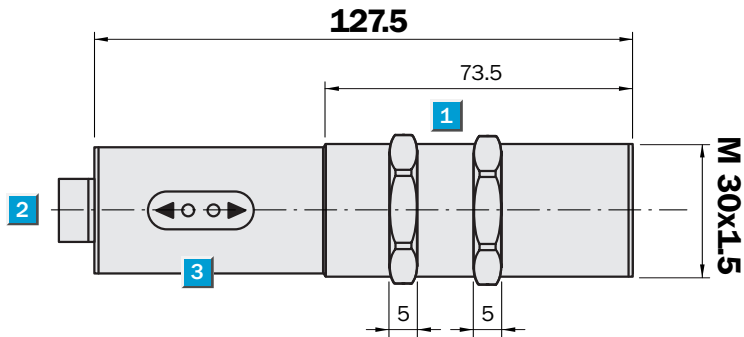

Adjustments possible

All types

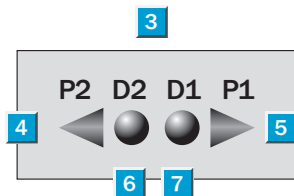

- 1 Fastening nuts, width across 36 mm
- 2 Connection plug M12
- 3 Control and display panel
- 4 Setting key 2
- 5 Setting key 1
- 6 LED 2
- 7 LED 1

Connection types

UM30-12115
UM30-11115
UM30-13115

UM30-11114
UM30-13114
UM30-12114

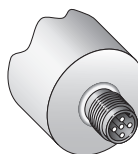
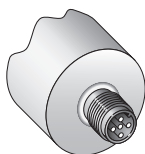

5-pin, M12

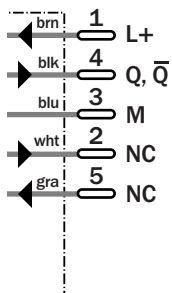

5-pin, M12

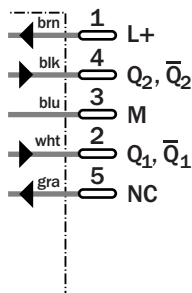

Accessories
Mounting systems

Technical data		UM30-	11115	11114	12115	12114	13115	13114				
Operating scanning range (limiting scanning range)	30 ... 250 mm (350)											
	60 ... 350 mm (600)											
	200 ... 1300 mm (2000)											
Ultrasonic frequency	320 kHz											
	400 kHz											
	200 kHz											
Resolution	0,36 mm											
Reproducibility	± 0.15 % of final value											
Accuracy	≤ 2 % of final value											
Supply voltage V_s	9 ... 30 V DC ¹⁾											
Residual ripple	± 10 %											
Current consumption ²⁾	≤ 60 mA											
Switching outputs, reversible³⁾	Q: NPN											
	Q ₁ , Q ₂ : 2 x NPN											
Response time	50 ms											
	70 ms											
	110 ms											
Switching frequency	11/s											
	8/s											
	6/s											
Switching hysteresis	20 mm											
	5 mm											
	2.5 mm											
Standby delay	2 s											
Connection type	Plug M12, 5-pin											
Enclosure rating	IP 65											
Ambient temperature	Operation -20 °C ... +70 °C ⁴⁾											
	Storage -40 °C ... +85 °C											
Weight	260 g											
Housing material ⁵⁾	Nickel-plated brass											

¹⁾ Limit values

²⁾ Without load

³⁾ Outputs short-circuit protected

$I_{max} = 200 \text{ mA}$

NPN: High = V_s / LOW ≤ 2 V

⁴⁾ Temperature compensation at -20 °C ... +65 °C

⁵⁾ Plastic parts: PBT
Ultrasonic transducer: Polyurethane-foam, glass epoxy resin

Detection ranges

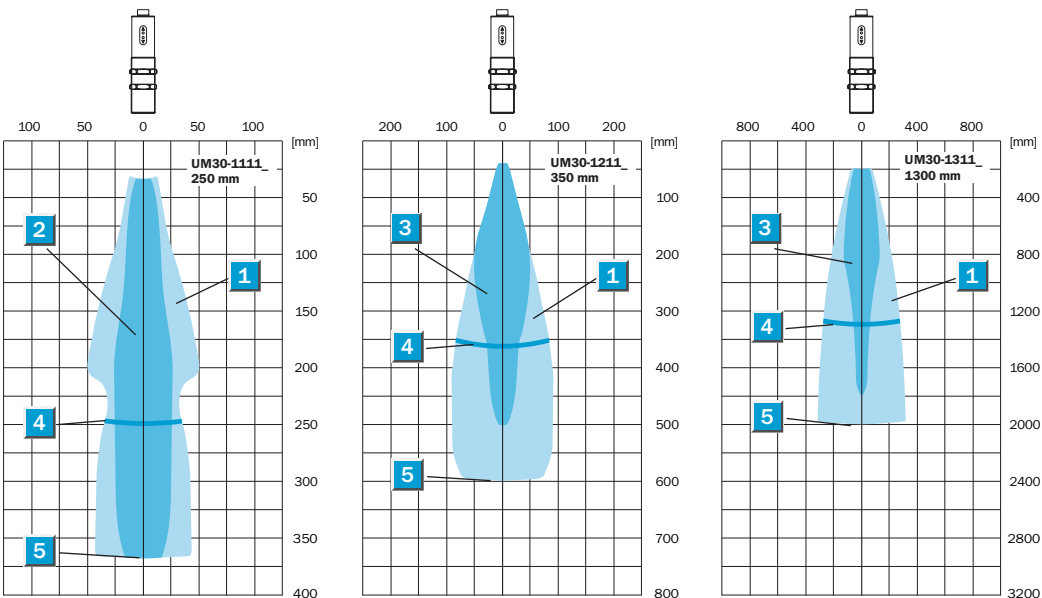

1	Aligned plate 500 x 500 mm
2	Pipe diameter 10 mm
3	Pipe diameter 27 mm

4	Operating scanning range
5	Limiting scanning range

Order information

Type	Order no.
UM30-11114	6030551
UM30-11115	6030542
UM30-12114	6030552
UM30-12115	6030543
UM30-13114	6030553
UM30-13115	6030544

UM30 Ultrasonic sensor

Operating scanning range
350 ... 3400 mm

Ultrasonic sensor

- Independent of material shape (including films, glass and bottles)
- Teach-in
- Insensitive to dirt, dust and fog
- Operating scanning range up to 3400 mm
- Binary outputs or analogue output

Dimensional drawing

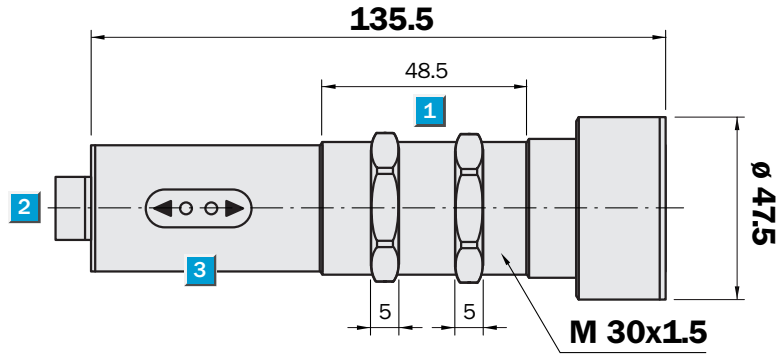

Adjustments possible

All types

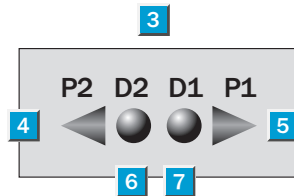

- 1 Fastening nuts, width across 36 mm
- 2 Connection plug M12
- 3 Control and display panel
- 4 Setting key 2
- 5 Setting key 1
- 6 LED 2
- 7 LED 1

Connection types

UM30-14111	UM30-14112	UM30-14113
UM30-14115	UM30-14114	

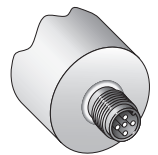
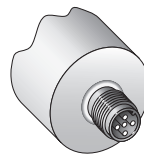
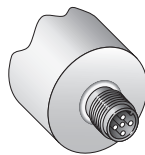

5-pin, M12

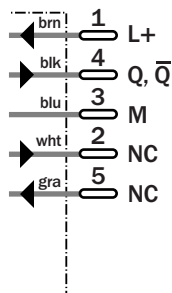

5-pin, M12

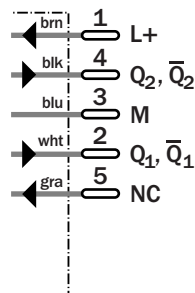

5-pin, M12

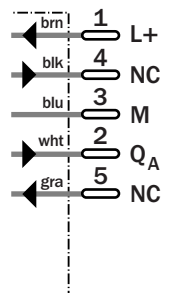

Accessories

Mounting systems

Technical data		UM30-	14111	14112	14113	14114	14115					
Operating scanning range	350 ... 3400 mm (5000)											
(limiting scanning range)												
Ultrasonic frequency	120 kHz											
Resolution	1 mm											
Reproducibility	± 0.15 % of final value											
Accuracy	≤ 2 % of final value											
Supply voltage V_s	DC 9 ... 30 V ¹⁾											
Residual ripple	± 10 %											
Current consumption ²⁾	≤ 60 mA											
Switching outputs, reversible³⁾	Q: PNP											
	Q: NPN											
	Q ₁ , Q ₂ : 2 x PNP											
	Q ₁ , Q ₂ : 2 x NPN											
Analogue output, reversible ^{3) 4)}	Q _A : 4 ... 20 mA/0 ... 10 V											
Response time	180 ms											
Switching frequency	3/s											
Switching hysteresis	50 mm											
Standby delay	2 s											
Connection type	Plug M12, 5-pin											
Enclosure rating	IP 65											
Ambient temperature⁵⁾	Operation -20 °C ... +70 °C											
	Storage -40 °C ... +85 °C											
Weight	310 g											
Housing material	Nickel-plated brass											

1) Limit values
 2) Without load
 3) Outputs short-circuit protected
 $I_{max} = 200 \text{ mA}$
 PNP: High = $V_s - (< 2 \text{ V}) / \text{LOW} = 0 \text{ V}$

NPN: High = $V_s / \text{LOW} \leq 2 \text{ V}$
 4) Automatic switching between voltage and current outputs dependent on load

Current output 4 ... 20 mA:
 $R_L \leq 500 \Omega, V_s \geq 20 \text{ V};$
 $R_L \leq 100 \Omega, V_s \geq 12 \text{ V}$
 Voltage output 0 ... 10 V:
 $R_L \geq 100 \text{ k}\Omega; V_s > 15 \text{ V}$

5) Temperature compensation at -20 ... +65 °C

Detection ranges

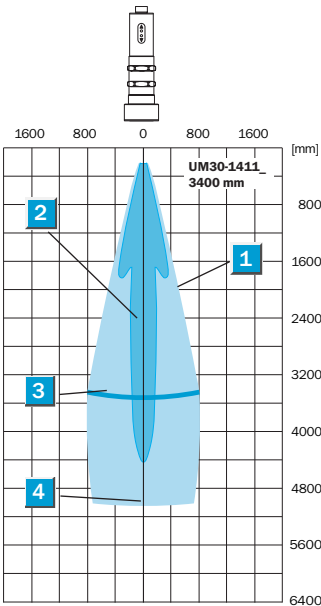

1	Aligned plate 500 x 500 mm
2	Pipe diameter 27 mm
3	Operating scanning range
4	Limiting scanning range

Order information

Type	Order no.
UM30-14111	6025658
UM30-14112	6025663
UM30-14113	6025668
UM30-14114	6030555
UM30-14115	6030546

Operating scanning range
800 ... 6000 mm

Ultrasonic sensor

- Independent of material shape (including films, glass and bottles)
- Teach-in
- Insensitive to dirt, dust and fog
- Operating scanning range up to 6000 mm
- Binary outputs or analogue output

Dimensional drawing

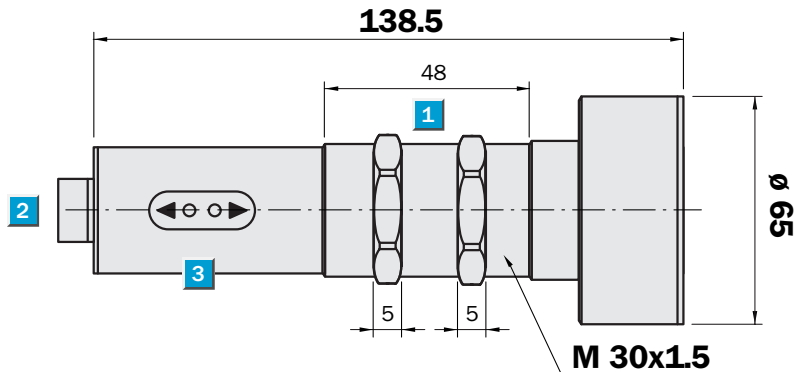

Adjustments possible

All types

- 1 Fastening nuts, width across 36 mm
- 2 Connection plug M12
- 3 Control and display panel
- 4 Setting key 2
- 5 Setting key 1
- 6 LED 2
- 7 LED 1

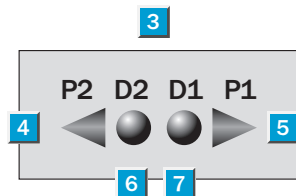

Connection types

UM30-15111	UM30-15112	UM30-15113
UM30-15115	UM30-15114	

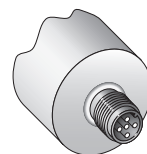
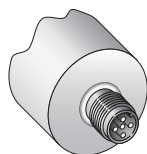
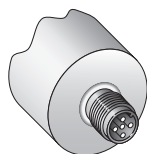

5-pin, M12

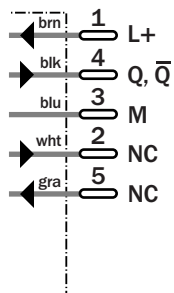

5-pin, M12

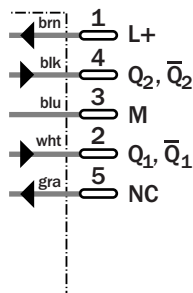

5-pin, M12

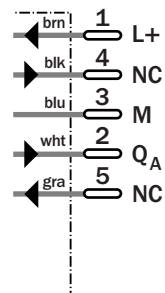

Accessories
Mounting systems

Technical data		UM30-	15111	15112	15113	15114	15115					
Operating scanning range	800 ... 6000 mm (8000)											
(limiting scanning range)												
Ultrasonic frequency	80 kHz											
Resolution	1 mm											
Reproducibility	± 0.15 % of final value											
Accuracy	≤ 2 % of final value											
Supply voltage V_s	DC 9 ... 30 V ¹⁾											
Residual ripple	± 10 %											
Current consumption ²⁾	≤ 60 mA											
Switching outputs, reversible³⁾	Q: PNP											
	Q: NPN											
	Q ₁ , Q ₂ : 2 x PNP											
	Q ₁ , Q ₂ : 2 x NPN											
Analogue output, reversible ^{3) 4)}	Q _A : 4 ... 20 mA/0 ... 10 V											
Response time	240 ms											
Switching frequency	2/s											
Switching hysteresis	100 mm											
Standby delay	2 s											
Connection type	Plug M12, 5-pin											
Enclosure rating	IP 65											
Ambient temperature ⁵⁾	Operation -20 °C ... +70 °C											
	Storage -40 °C ... +85 °C											
Weight	360 g											
Housing material	Nickel-plated brass											

1) Limit values
 2) Without load
 3) Outputs short-circuit protected
 $I_{max} = 200 \text{ mA}$
 PNP: High = $V_s - (< 2 \text{ V}) / \text{LOW} = 0 \text{ V}$
 NPN: High = $V_s / \text{LOW} \leq 2 \text{ V}$
 4) Automatic switching between voltage and current outputs dependent on load
 Current output 4 ... 20 mA:
 $R_L \leq 500 \Omega, V_s \geq 20 \text{ V};$
 $R_L \leq 100 \Omega, V_s \geq 12 \text{ V}$
 Voltage output 0 ... 10 V:
 $R_L \geq 100 \text{ k}\Omega; V_s > 15 \text{ V}$
 5) Temperature compensation at -20 ... +65 °C

Detection ranges

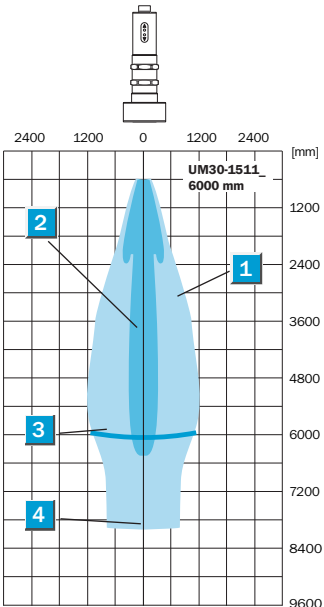

- 1 Aligned plate 500 x 500 mm
- 2 Pipe diameter 27 mm
- 3 Operating scanning range
- 4 Limiting scanning range

Order-information

Type	Order no.
UM30-15111	6025659
UM30-15112	6025664
UM30-15113	6025669
UM30-15114	6030556
UM30-15115	6030547

Dimensional drawings and order informations

SENSICK screw-in system M12, 5-pin, enclosure rating IP 67

- Contact assignment according to EN 50 044
- DC coding

Pin assignment

Pin 1 = brown

Pin 2 = white

Pin 3 = blue

Pin 4 = black

Pin 5 = grey

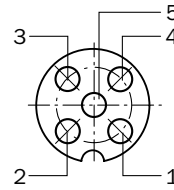

Female connector M12, 5-pin, straight

Type	Order no.	Contacts
DOS-1205-G	6009719	5

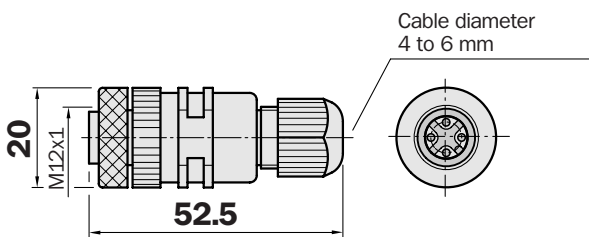

Female connector M12, 5-pin, right angle

Type	Order no.	Contacts
DOS-1205-W	6009720	5

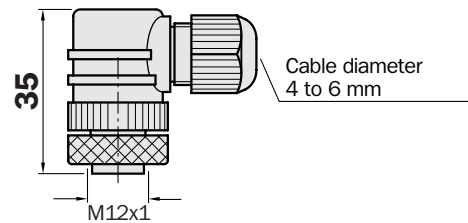
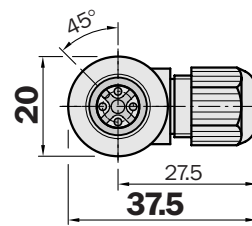

Female connector M12, 5-pin, straight

Cable diameter 6 mm, 5 x 0.25 mm², sheath PVC

Type	Order no.	Contacts	Cable length
DOL-1205-G02M	6008899	5	2 m
DOL-1205-G05M	6009868	5	5 m
DOL-1205-G10M	6010544	5	10 m

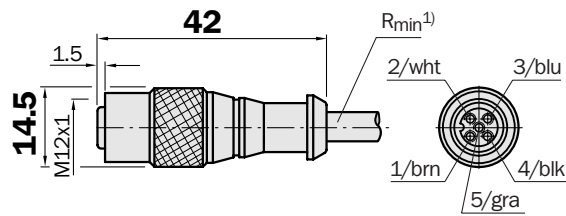

Female connector M12, 5-pin, right angle

Cable diameter 6 mm, 5 x 0.25 mm², sheath PVC

Type	Order no.	Contacts	Cable length
DOL-1205-W02M	6008900	5	2 m
DOL-1205-W05M	6009869	5	5 m
DOL-1205-W10M	6010542	5	10 m

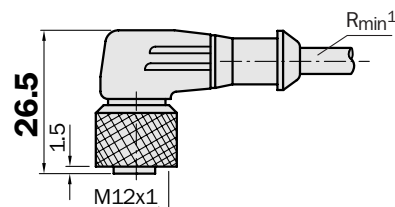
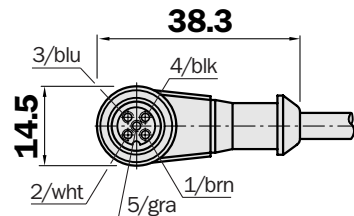

Dimensional drawings and order informations

Mounting bracket for UM18

Type	Order no.
BEF-WN-M18	5308446

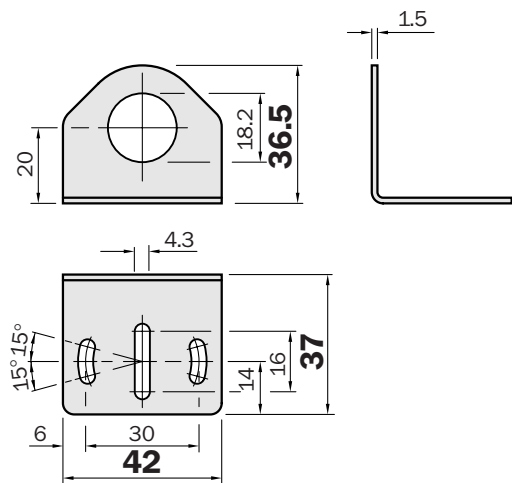

Mounting bracket for UM30

Type	Order no.
BEF-WN-M30	5308445

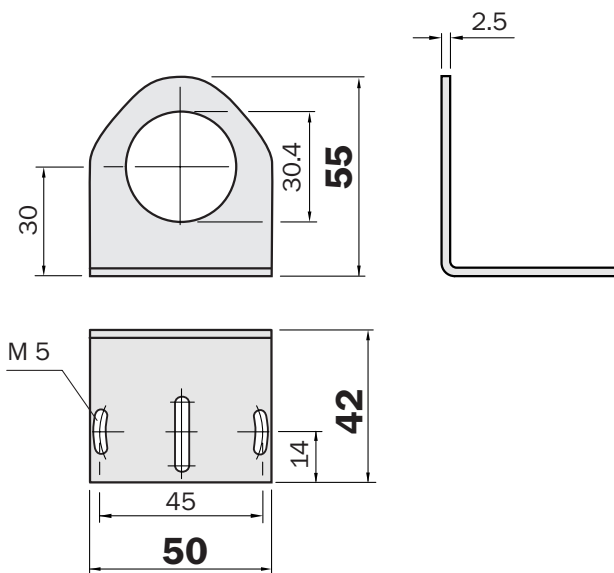

Diverter plate for UM30 to 1300 mm operating scanning range

Type	Order no.
USP-UM30	5312916

