



Ultrasonic Sensors

Detection Irrespective of Material, Colour and Illumination

Straightforward and with many benefits: Detection by ultrasonic.

Light and sound are two natural phenomena which let every living being recognise their environment without physical contact and over widely varying distances. Likewise, industrial processes require reliable information.

Detection and measurement, regardless of material

Transparent objects such as glass and film are often a difficult task for sensors, as are clear and coloured fluids. But it is hard to deceive ultrasonic. Almost all materials affect and reflect sound waves.

Never confused by loud colours

Not even the oddest colours can bias ultrasonic sensors. Reflecting objects do not irritate them at all. When objects change colour, there is no need to readjust the sensors. They just go on working as before – can anyone think of a more convenient way?





SICK's ultrasonic sensors detect objects and measure distances with high accuracy. The realm of sound is a world of its own, and for this reason ultrasonic sensors are simply the better choice in many industrial applications requiring sensor technology.

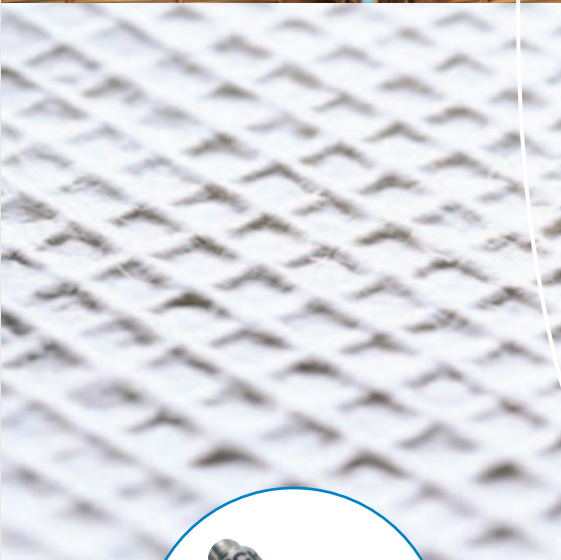
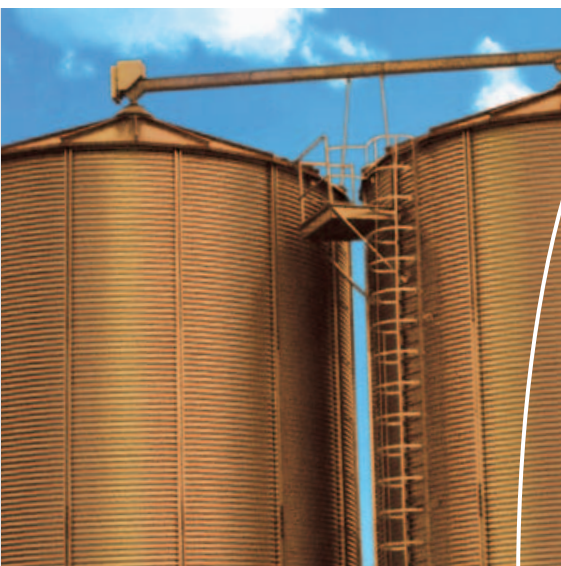

**Highly available,
even under difficult conditions**

Dust and dirt, steam and spray are no problem for ultrasonic sensors. Unfavourable environments have little effect on them. Interferences are simply "blanked out". And they do not even mind strong light and adverse temperatures.

**Sound has an advantage -
even on superficial inspection**

Whether the surface is rough or smooth, reflecting or retroreflecting, regular or irregular in shape, ultrasonic sensors are generally unaffected. They detect objects reliably and almost independently of their appearance.

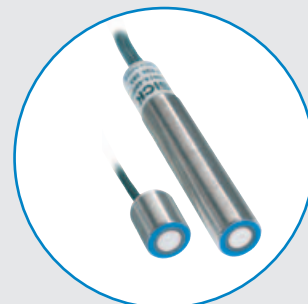

Ultrasonic proximity sensors UM30, UM18 and UC12 – powerful devices for almost any application.

Even when it's extremely dusty: The ultrasonic proximity sensors are not impaired by foreign bodies in the air, mist, vapour and dirt. Even the background suppression is near perfect. We call this concentrating on the essentials.

UM 30



Far and near – different scanning ranges

Short, medium or long-distance? The UM30 has three different scanning ranges. The minimum operating distance begins at a minute 30 mm, and for really long-distance applications, to the limit of the scanning range is astonishing 6000 mm.

Detection or measurement as required

The UM30 can be fitted with a binary output or analogue interface. Depending on the task on hand, objects can simply be detected or their distance measured.

UM 18



Smaller diameter with the same functionality

The UM18 has 1 or 2 switching outputs and extended features (for instance, ObSB mode): The sensor is taught a fixed background and reliably switches when an object is detected between sensor and background: Perfect for detecting round or tilted surfaces!

Typical applications

- Level control of solids and liquids
- Checking presence of outer packaging
- Assignment control during packaging
- Checking presence of PET bottles
- Diameter control
- Loop control

Typical applications

- Positioning of small objects in tight environments
- Checking for the presence of small, transparent or opaque outer packaging



UC12



After 2 seconds/shortest time to operation

Position object, press Teach-in button, ready. There is no faster way to commission an ultrasonic sensor. This flexibility is further enhanced by the ObSB and window modes.

- Typical applications**
- Checking presence of very dark objects
 - Level control in the food and drinks industry
 - Detecting transparent packaging
 - Detecting printed/coloured paper during the printing process



Ultrasonic proximity sensors point by point

Easy to learn – Teach-in

Setting a sensor’s parameters can sometimes be time consuming – unless you just show it what to do. We call that “Teach-in”. This makes the UM30 quick and easy to handle. And when changes have to be made, it can be re-taught in a jiffy to cope with the new situation.

Well balanced and reliable – temperature compensation

Ultrasonic time measurements depend on the state of the medium transmitting the sound, i.e. the air. UM30 sensors balance temperature fluctuations out automatically, thereby ensuring precision and reliability.

Current or voltage – the appropriate signal automatically

The analogue output of the UM30 sensor switches automatically between current and voltage. With its 4 to 20 mA or 0 to 10 V DC, it fits perfectly into any measuring environment.

Q or \bar{Q} , no problem here

What signal does the application require, Q or \bar{Q} ? The UM30 has an invertible switching output and can cope with both.

ObSB mode – Object between sensor and background

Perfect for detecting round and tilted surfaces, UM18 and UC12.

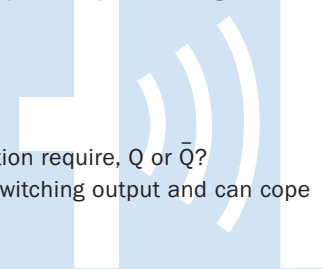

Mode of operation: detecting, measuring and switching with ultrasonic proximity sensors.

The detection of objects with ultrasonic sensors opens up a new dimension. Objects are positioned, detected and controlled virtually irrespective of material and environment.

Sensors with a profile – defining the detection area

SICK Ultrasonic Sensors generate an ultrasonic wave by means of a piezo element in the front part of the housing. The wave spreads in the atmosphere in accordance with the laws of physics. The same piezo element can detect and measure the sound reflected by an object. Therefore it functions alternately as sender and receiver (transceiver).

The measurement principle of ultrasonic sensors is based on the time taken for ultrasonic to travel through the medium air. The signals are transmitted in defined “packages”.

With the help of its processing electronics, the transceiver evaluates the time taken between the transmission of a sound “package” and the arrival of the reflection from an object. As a result, either a signal proportionate to the distance is sent via an analogue interface, or a switching signal depending on a previously set distance parameter is sent through a binary output. The accuracy of the measurement and the maximum scanning range lie within a tolerance range which depends mainly on the state of the carrier medium air and the roughness of the object in question.

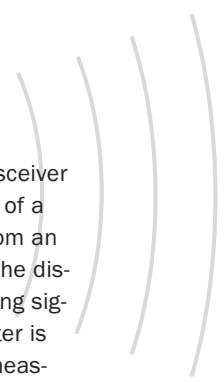

Positioning

Object detection and distance measurement independent of material

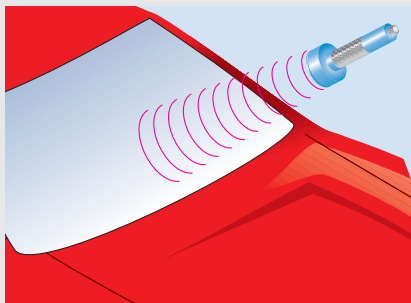

Detection

Recognise transparent objects

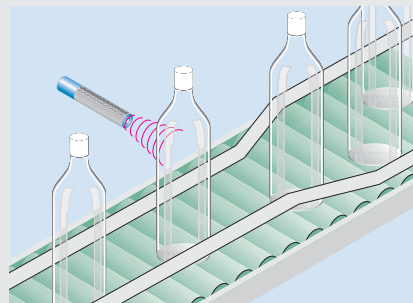

Unwind

Distance measurement for diameter check

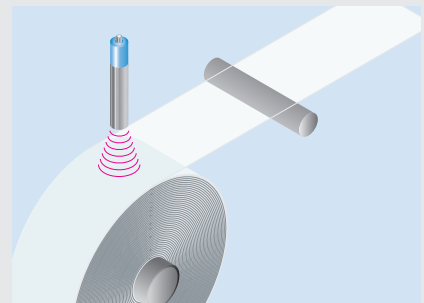

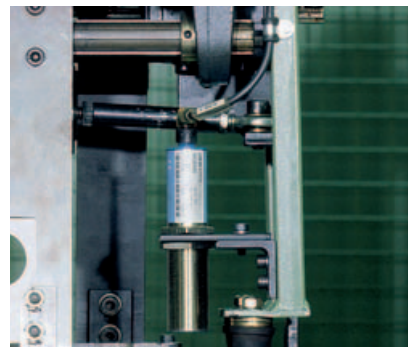
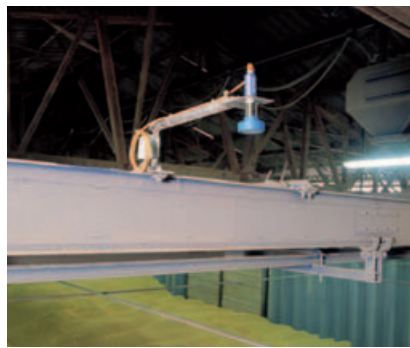

Sensors in action – scanning and measuring reflections

Ultrasonic sensors UM30 are used as non-contact proximity switches which process reflected signals, e.g. from objects on a conveyor belt. An essential benefit of the working principle of ultrasonic sensors is the almost complete blanking of the background, a prerequisite for accurate detection.

Scanning round corners – thanks to the right accessories

Ultrasonic sensors UM30 are small and easily installed even in confined spaces. And if things get really tight, the right accessories can help out. Suitable reflectors allow sound to be deflected almost without loss.

Package

“Engaged” check on package content

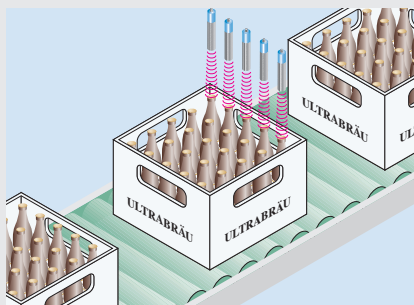

Adjust

Control material looping

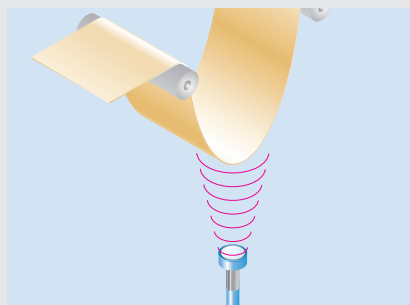

Monitoring

Level control in silos and containers

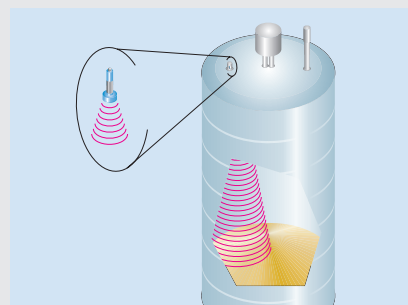

Ultrasonic double-sheet control UM18, the specialist for double layers – with smart vision.

UM18 FOR DOUBLE-SHEET CONTROL



When ultrasonic is used to detect two thin sheets, one of which is immediately behind the other, e.g. paper, film or thin sheet material, separate sender and receiver units are required. The continuously transmitted sonic waves packages cause vibrations in the first sheet which it then transmits via the intervening air to the second sheet, which also begins to vibrate. The receiver unit is able to detect these weakened signals via the air.

The sender and receiver units of the UM18 are only 40 mm apart and work effectively without having to be parametered. They adjust automatically to a wide spectrum of different materials.

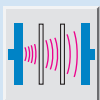

UM18 sheet for sheet

- Double-sheet check for film, paper, corrugated cardboard and fine metal sheet
- Automatic adjustment Alignment and Teach-in unnecessary
- Compact design
- Plug and Play
- 2 PNP outputs for double- and mis-fed-sheets

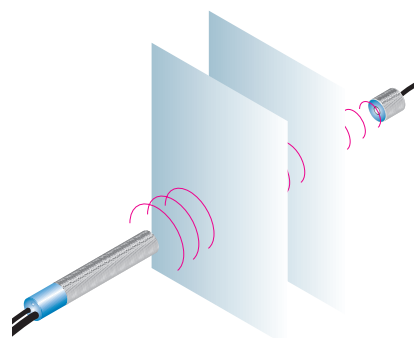
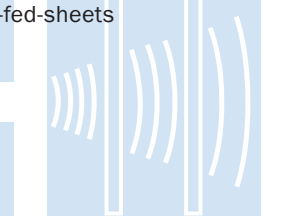

No need to tell it what to do

The UM18 adjusts to its task itself. Fully automatically. Film down to 0.4 mm in thickness, paper of 1200 g/m² or metal sheet of 0.3 mm thickness – almost anything is detected.

A sensor that does not stop at the surface

Detection of two superimposed sheets of material is no easy matter.

The UM18 can find out whether one or two sheets of film, paper, metal or cardboard lie between its sender and receiver. Which other sensor is able to look beyond the surface?

Small and versatile

The sender and receiver of the UM18 are located in an 18 mm threaded tube, and, because they are mounted only 40 mm apart, can be accommodated in the most confined spaces.

With regard to alignment to the sheets, the UM18 is undemanding. It puts up with as much as 45 degrees deviation from the vertical.

Detection range and assembly of ultrasonic sensors.

Detection range

To determine the area of detection of the sensors, a series of measurements are carried out with two standardised objects, a thin round rod and a plate. The three-dimensional area within which the sensor responds to the rod has the form of a thin club. It marks the typical operating scanning range of the sensor.

The sensor responds to the plate within the area of a larger beam. This area defines the maximum or limit detection range of the sensor.

When projected onto a two-dimensional grid, typical profiles are created. These are the operating diagrams of the ultrasonic sensors, from which the operating scanning range, the limiting scanning range, the specific shape and the blind zone of the detection range can be read off. Objects which are smaller than the round rod may only be detected within an area smaller than the operating scanning range.

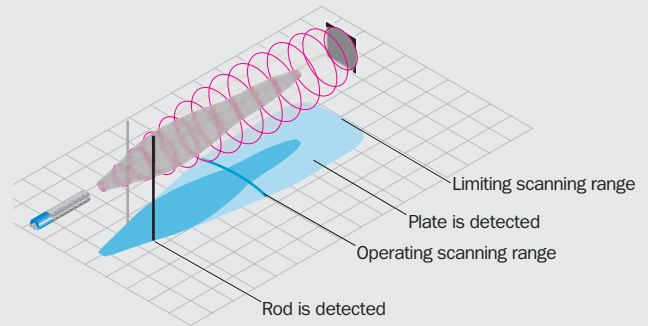

Every ultrasonic sensor has its characteristic club-shaped detection range. It is narrow for smaller objects and wide for larger ones. The typical detection areas are depicted by sound-beam diagrams.

Installation

Ultrasonic sensors installed close together or opposite one another may affect each other mutually. For this reason, different axial and lateral distances have to be maintained depending on the detection range. The sensor with the largest detection range determines the minimum distance.

Operating scanning range	Min. installation distance A	Min. installation distance B
0.25 m	10 cm	> 100 cm
0.35 m	> 30 cm	> 170 cm
1.3 m	> 60 cm	> 540 cm
3.4 m	> 160 cm	> 1600 cm
6 m	> 260 cm	> 3000 cm

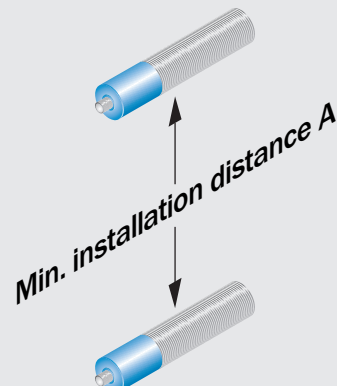
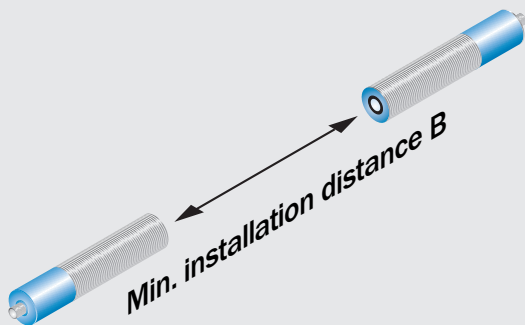

Operating scanning range
30 ... 1300 mm

Ultrasonic sensor

- Independent of material shape (including films, glass and bottles)
- Teach-in
- Insensitive to dirt, dust and fog
- Operating scanning range up to 1300 mm
- Binary outputs or analogue output

Dimensional drawing

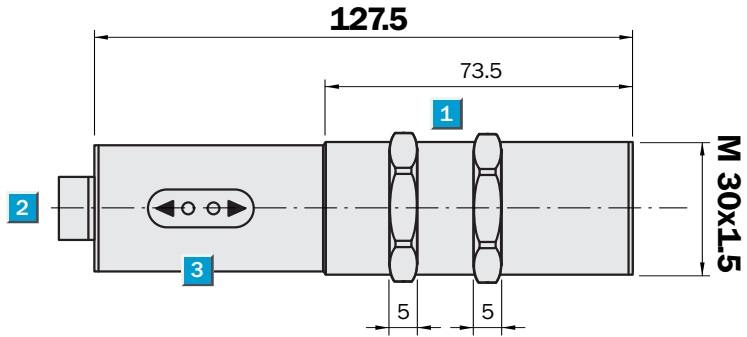

Adjustments possible

All types

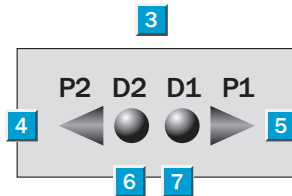

- 1 Fastening nuts, width across 36 mm
- 2 Connection plug M12
- 3 Control and display panel
- 4 Setting key 2
- 5 Setting key 1
- 6 LED 2
- 7 LED 1



Connection types

UM30-11111	UM30-11112	UM30-11113
UM30-12111	UM30-12112	UM30-12113
UM30-13111	UM30-13112	UM30-13113

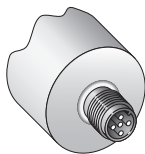

5-pin, M12

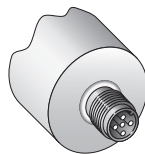
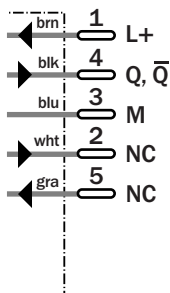

5-pin, M12

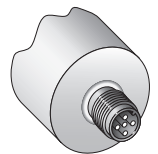
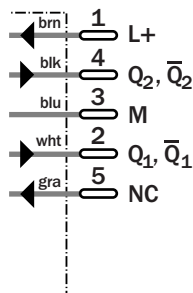

5-pin, M12

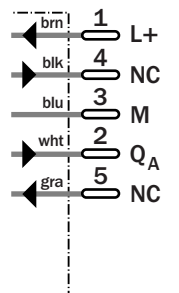

Accessories

Mounting systems

Technical data		UM30-	11111	11112	11113	12111	12112	12113	13111	13112	13113
Operating scanning range (limiting scanning range)	30 ... 250 mm (350)										
	60 ... 350 mm (600)										
Ultrasonic frequency	200 ... 1300 mm (2000)										
	320 kHz										
	400 kHz										
Resolution	200 kHz										
	0.36 mm										
Reproducibility	± 0.15 % of final value										
Accuracy	≤ 2 % of final value										
Supply voltage V_s	9 ... 30 V DC ¹⁾										
Residual ripple	± 10 %										
Current consumption ²⁾	≤ 60 mA										
Switching outputs, reversible ³⁾	Q: PNP										
	Q_1, Q_2 : 2 x PNP										
Analogue output, reversible ^{3) 4)}	Q_A : 4 ... 20 mA/0 ... 10 V										
Response time	50 ms										
	70 ms										
	110 ms										
Switching frequency	11/s										
	8/s										
	6/s										
Switching hysteresis	20 mm										
	5 mm										
	2.5 mm										
Standby delay	2 s										
Connection type	Plug M12, 5-pin										
Enclosure rating	IP 65										
Ambient temperature	Operation -20 °C ... +70 °C										
	Storage -40 °C ... +85 °C										
Weight	260 g										
Housing material	Nickel-plated brass										

1) Limit values
 2) Without load
 3) Outputs short-circuit protected
 $I_{max} = 200 \text{ mA}$
 PNP: High = $V_s - (< 2 \text{ V})$ /LOW = 0 V

4) Automatic switching between voltage and current outputs dependent on load

Current output 4 ... 20 mA:
 $R_L \leq 500 \Omega, V_s \geq 20 \text{ V};$
 $R_L \leq 100 \Omega, V_s \geq 12 \text{ V}$
 Voltage output 0 ... 10 V:
 $R_L \geq 100 \text{ k}\Omega; V_s > 15 \text{ V}$

5) Temperature compensation at -20 ... +65 °C
 6) Plastic parts: PBT
 Ultrasonic transducer: Polyurethane-foam, glass epoxy resin

Detection ranges

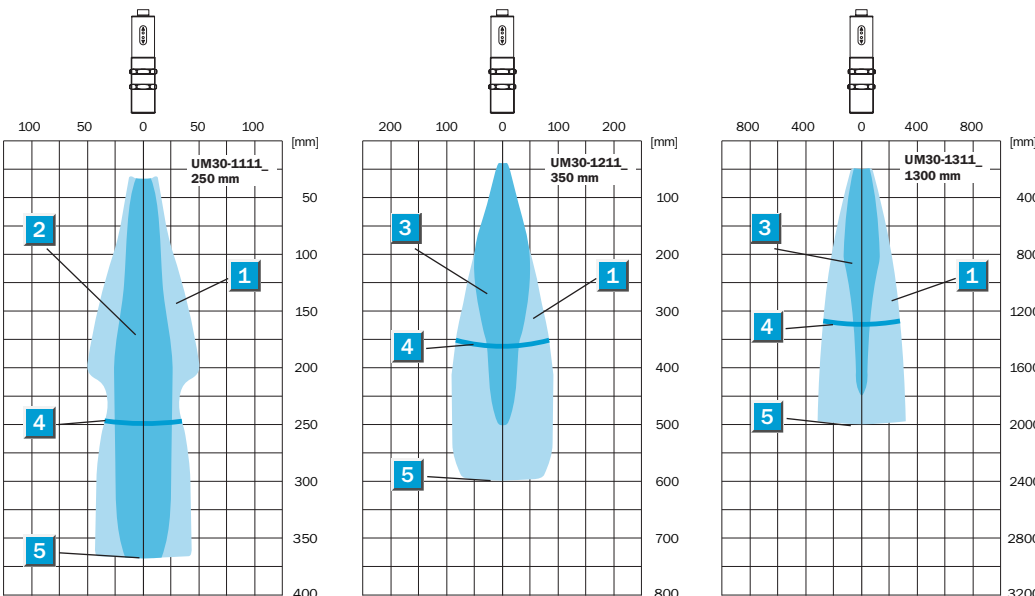

1	Aligned plate 500 x 500 mm
2	Pipe diameter 10 mm
3	Pipe diameter 27 mm

4	Operating scanning range
5	Limiting scanning range

Order information

Type	Order no.
UM30-11111	6025655
UM30-12111	6025656
UM30-13111	6025657
UM30-11112	6025660
UM30-12112	6025661
UM30-13112	6025662
UM30-11113	6025665
UM30-12113	6025666
UM30-13113	6025667

Operating scanning range
30 ... 1300 mm

Ultrasonic sensor

- Independent of material shape (including films, glass and bottles)
- Teach-in
- Insensitive to dirt, dust and fog
- Operating scanning range up to 1300 mm
- Binary outputs or analogue output

Dimensional drawing

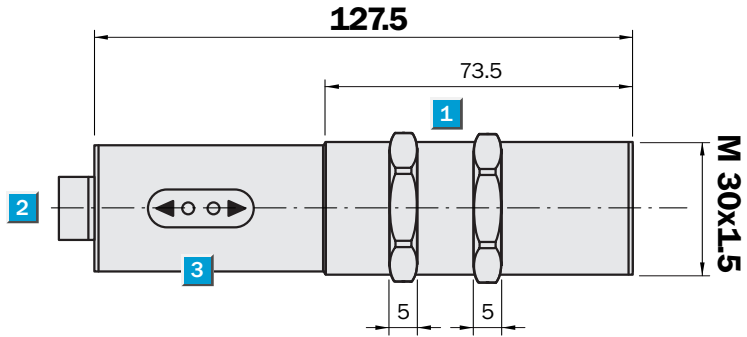

Adjustments possible

All types

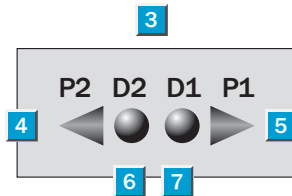

- 1 Fastening nuts, width across 36 mm
- 2 Connection plug M12
- 3 Control and display panel
- 4 Setting key 2
- 5 Setting key 1
- 6 LED 2
- 7 LED 1



Connection types

UM30-12115
UM30-11115
UM30-13115

UM30-11114
UM30-13114
UM30-12114

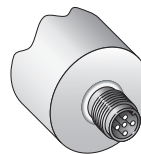
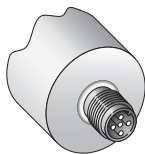

5-pin, M12

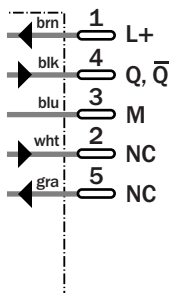

5-pin, M12

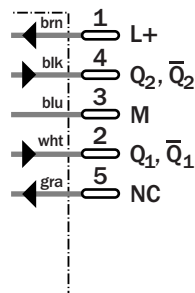

Accessories

Mounting systems

Technical data		UM30-	11115	11114	12115	12114	13115	13114				
Operating scanning range (limiting scanning range)	30 ... 250 mm (350)											
	60 ... 350 mm (600)											
	200 ... 1300 mm (2000)											
Ultrasonic frequency	320 kHz											
	400 kHz											
	200 kHz											
Resolution	0,36 mm											
Reproducibility	± 0.15 % of final value											
Accuracy	≤ 2 % of final value											
Supply voltage V_s	9 ... 30 V DC ¹⁾											
Residual ripple	± 10 %											
Current consumption ²⁾	≤ 60 mA											
Switching outputs, reversible³⁾	Q: NPN											
	Q ₁ , Q ₂ : 2 x NPN											
Response time	50 ms											
	70 ms											
	110 ms											
Switching frequency	11/s											
	8/s											
	6/s											
Switching hysteresis	20 mm											
	5 mm											
	2.5 mm											
Standby delay	2 s											
Connection type	Plug M12, 5-pin											
Enclosure rating	IP 65											
Ambient temperature	Operation -20 °C ... +70 °C ⁴⁾											
	Storage -40 °C ... +85 °C											
Weight	260 g											
Housing material ⁵⁾	Nickel-plated brass											

¹⁾ Limit values

²⁾ Without load

³⁾ Outputs short-circuit protected
 $I_{max} = 200 \text{ mA}$
 NPN: High = $V_s / \text{LOW} \leq 2 \text{ V}$

⁴⁾ Temperature compensation at -20 °C ... +65 °C

⁵⁾ Plastic parts: PBT
 Ultrasonic transducer: Polyurethane-foam, glass epoxy resin

Detection ranges

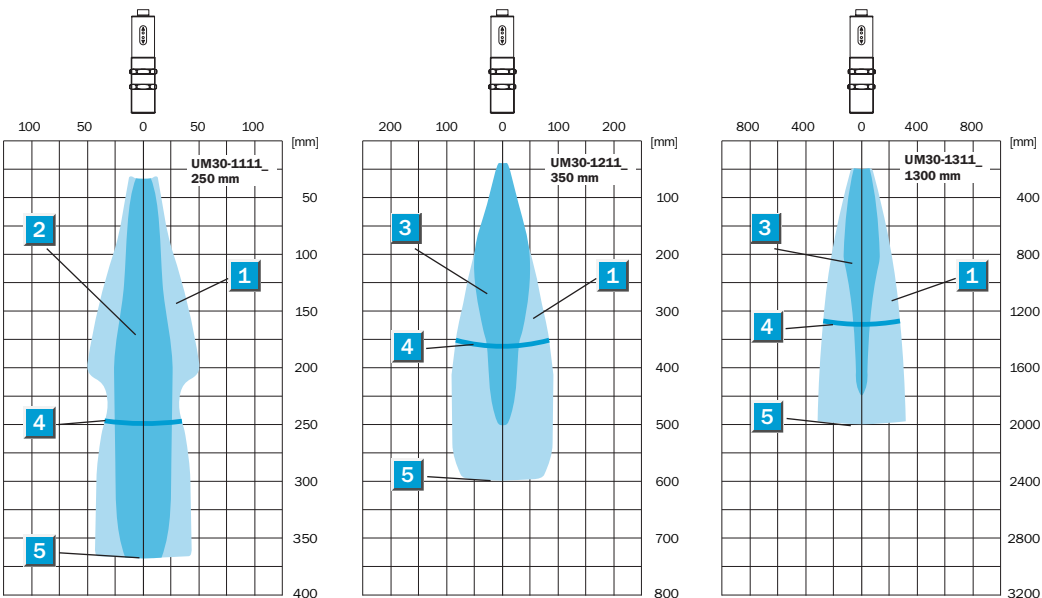

- 1** Aligned plate 500 x 500 mm
- 2** Pipe diameter 10 mm
- 3** Pipe diameter 27 mm

- 4** Operating scanning range
- 5** Limiting scanning range

Order information

Type	Order no.
UM30-11114	6030551
UM30-11115	6030542
UM30-12114	6030552
UM30-12115	6030543
UM30-13114	6030553
UM30-13115	6030544

Operating scanning range
350 ... 3400 mm

Ultrasonic sensor

- Independent of material shape (including films, glass and bottles)
- Teach-in
- Insensitive to dirt, dust and fog
- Operating scanning range up to 3400 mm
- Binary outputs or analogue output

Dimensional drawing

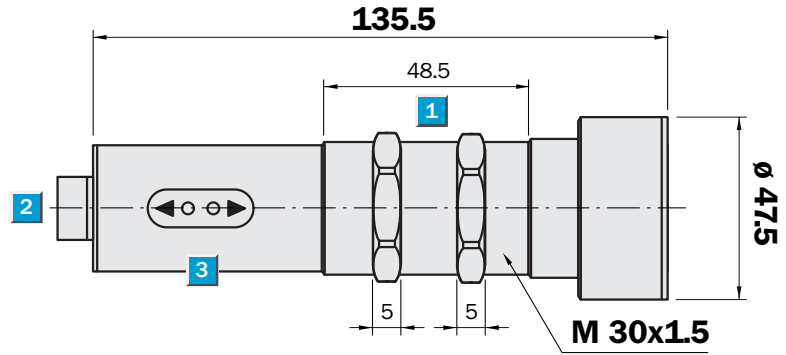

Adjustments possible

All types

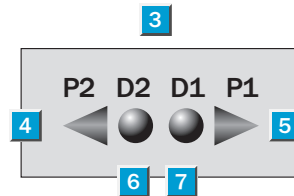

- 1 Fastening nuts, width across 36 mm
- 2 Connection plug M12
- 3 Control and display panel
- 4 Setting key 2
- 5 Setting key 1
- 6 LED 2
- 7 LED 1



Connection types

UM30-14111	UM30-14112	UM30-14113
UM30-14115	UM30-14114	

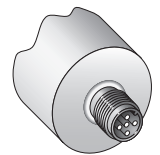
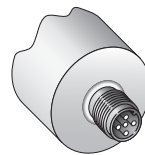
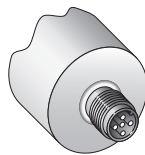

5-pin, M12

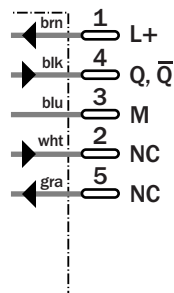

5-pin, M12

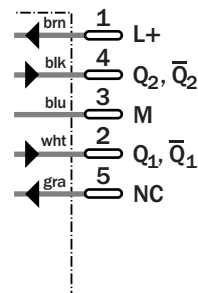

5-pin, M12

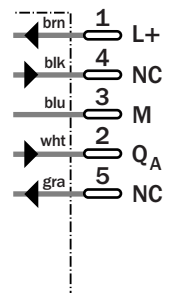

Accessories

Mounting systems

Technical data		UM30-	14111	14112	14113	14114	14115					
Operating scanning range	350 ... 3400 mm (5000)											
(limiting scanning range)												
Ultrasonic frequency	120 kHz											
Resolution	1 mm											
Reproducibility	± 0.15 % of final value											
Accuracy	≤ 2 % of final value											
Supply voltage V_s	DC 9 ... 30 V ¹⁾											
Residual ripple	± 10 %											
Current consumption ²⁾	≤ 60 mA											
Switching outputs, reversible³⁾	Q: PNP											
	Q: NPN											
	Q ₁ , Q ₂ : 2 x PNP											
	Q ₁ , Q ₂ : 2 x NPN											
Analogue output, reversible ^{3) 4)}	Q _A : 4 ... 20 mA/0 ... 10 V											
Response time	180 ms											
Switching frequency	3/s											
Switching hysteresis	50 mm											
Standby delay	2 s											
Connection type	Plug M12, 5-pin											
Enclosure rating	IP 65											
Ambient temperature⁵⁾	Operation -20 °C ... +70 °C											
	Storage -40 °C ... +85 °C											
Weight	310 g											
Housing material	Nickel-plated brass											

1) Limit values
 2) Without load
 3) Outputs short-circuit protected
 $I_{max} = 200 \text{ mA}$
 PNP: High = $V_s - (< 2 \text{ V}) / \text{LOW} = 0 \text{ V}$

NPN: High = $V_s / \text{LOW} \leq 2 \text{ V}$
 4) Automatic switching between voltage and current outputs dependent on load

Current output 4 ... 20 mA:
 $R_L \leq 500 \Omega, V_s \geq 20 \text{ V};$
 $R_L \leq 100 \Omega, V_s \geq 12 \text{ V}$
 Voltage output 0 ... 10 V:
 $R_L \geq 100 \text{ k}\Omega; V_s > 15 \text{ V}$

5) Temperature compensation at -20 ... +65 °C

Detection ranges

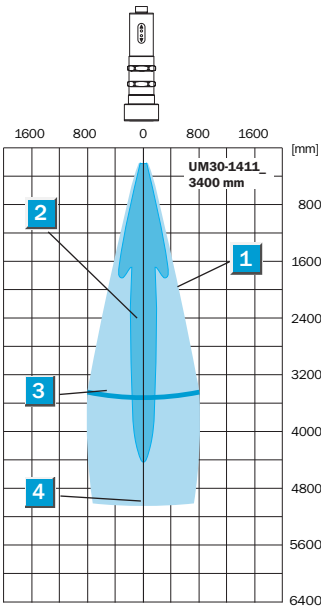

- 1 Aligned plate 500 x 500 mm
- 2 Pipe diameter 27 mm
- 3 Operating scanning range
- 4 Limiting scanning range

Order information

Type	Order no.
UM30-14111	6025658
UM30-14112	6025663
UM30-14113	6025668
UM30-14114	6030555
UM30-14115	6030546

Operating scanning range
800 ... 6000 mm

Ultrasonic sensor

- Independent of material shape (including films, glass and bottles)
- Teach-in
- Insensitive to dirt, dust and fog
- Operating scanning range up to 6000 mm
- Binary outputs or analogue output

Dimensional drawing

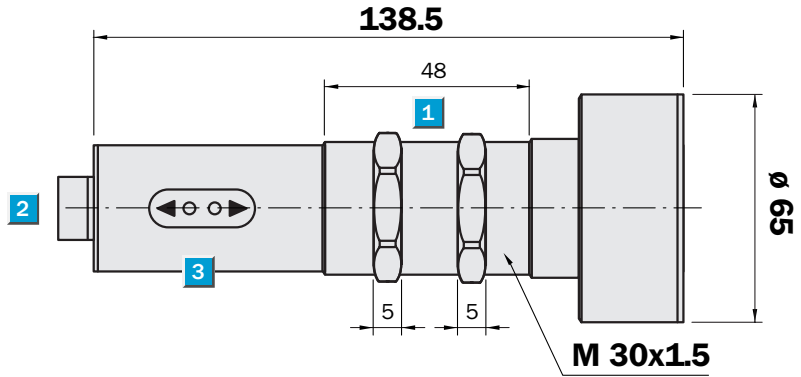

Adjustments possible

All types

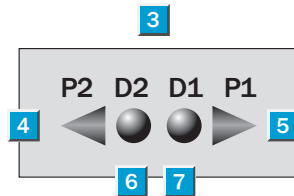

- 1 Fastening nuts, width across 36 mm
- 2 Connection plug M12
- 3 Control and display panel
- 4 Setting key 2
- 5 Setting key 1
- 6 LED 2
- 7 LED 1

Connection types

UM30-15111	UM30-15112	UM30-15113
UM30-15115	UM30-15114	

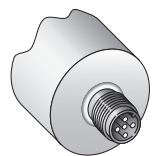
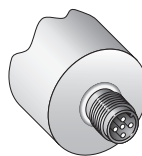
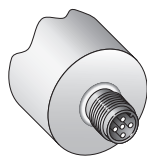

5-pin, M12

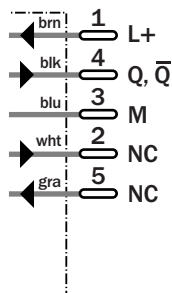

5-pin, M12

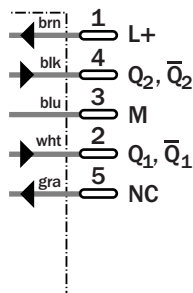

5-pin, M12

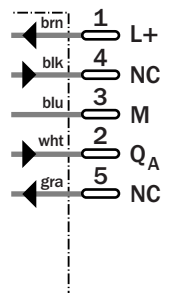

Accessories

Mounting systems

Technical data		UM30-	15111	15112	15113	15114	15115					
Operating scanning range	800 ... 6000 mm (8000)											
(limiting scanning range)												
Ultrasonic frequency	80 kHz											
Resolution	1 mm											
Reproducibility	± 0.15 % of final value											
Accuracy	≤ 2 % of final value											
Supply voltage V_s	DC 9 ... 30 V ¹⁾											
Residual ripple	± 10 %											
Current consumption ²⁾	≤ 60 mA											
Switching outputs, reversible³⁾	Q: PNP											
	Q: NPN											
	Q ₁ , Q ₂ : 2 x PNP											
	Q ₁ , Q ₂ : 2 x NPN											
Analogue output, reversible ^{3) 4)}	Q _A : 4 ... 20 mA/0 ... 10 V											
Response time	240 ms											
Switching frequency	2/s											
Switching hysteresis	100 mm											
Standby delay	2 s											
Connection type	Plug M12, 5-pin											
Enclosure rating	IP 65											
Ambient temperature⁵⁾	Operation -20 °C ... +70 °C											
	Storage -40 °C ... +85 °C											
Weight	360 g											
Housing material	Nickel-plated brass											

1) Limit values
 2) Without load
 3) Outputs short-circuit protected
 $I_{max} = 200 \text{ mA}$
 PNP: High = $V_s - (< 2 \text{ V}) / \text{LOW} = 0 \text{ V}$
 NPN: High = $V_s / \text{LOW} \leq 2 \text{ V}$
 4) Automatic switching between voltage and current outputs dependent on load
 Current output 4 ... 20 mA:
 $R_L \leq 500 \Omega, V_s \geq 20 \text{ V};$
 $R_L \leq 100 \Omega, V_s \geq 12 \text{ V}$
 Voltage output 0 ... 10 V:
 $R_L \geq 100 \text{ k}\Omega; V_s > 15 \text{ V}$
 5) Temperature compensation at -20 ... +65 °C

Detection ranges

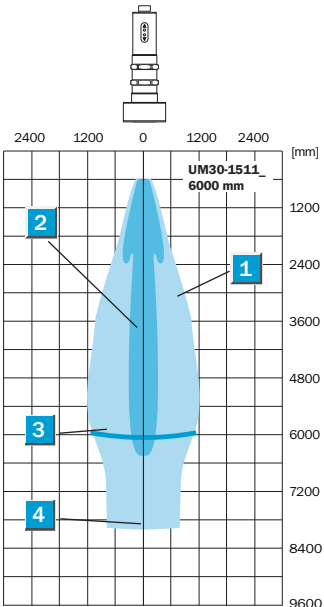

- 1 Aligned plate 500 x 500 mm
- 2 Pipe diameter 27 mm
- 3 Operating scanning range
- 4 Limiting scanning range

Order-information

Type	Order no.
UM30-15111	6025659
UM30-15112	6025664
UM30-15113	6025669
UM30-15114	6030556
UM30-15115	6030547

UM18 Ultrasonic sensor



Operating distance
30 ... 250 mm

Ultrasonic sensor

- Independent of material shape (also foils, glass, bottles)
- Insensitive to dirt, dust and fog
- 1 switching output or 2 switching outputs (PNP or NPN) or analogue output
- Teach-in via control input MF

Dimensional drawing

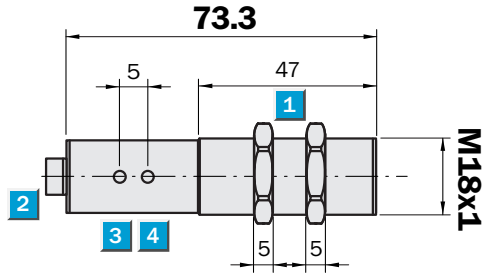

- 1** Locking nuts, 24 mm A/F
- 2** Connection plug M12
- 3** LED 1 (UM18-51112, UM18-51114, UM18-11116 and UM18-11117)
- 4** LED 2 (UM18-51112, UM18-51114, UM18-11116 and UM18-11117)



Connection types

UM18-51111	UM18-51112	UM18-11116
UM18-51115	UM18-51114	UM18-11117

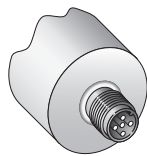

5-pin, M12

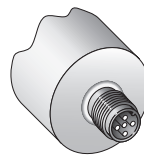
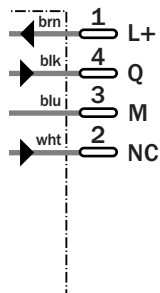

5-pin, M12

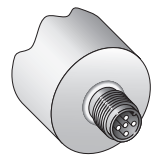
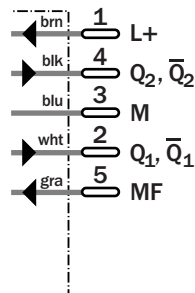

5-pin, M12

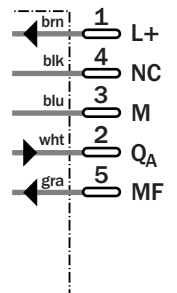

Technical data		UM18-	51111	51112	51114	51115	51116	51117				
Operating distance	30 mm ... 250 mm (< 350 mm)											
(maximum scanning distance)												
Ultrasonic frequency	320 kHz											
Resolution	0.36 mm											
Reproducibility	typ. ±0.15 % of final value											
Accuracy	≤ 2 % of final value											
Supply voltage V_s	$V_s = 10 \dots 30 \text{ V DC}^{1)}$											
Residual ripple	± 10 %											
Current consumption ²⁾	≤ 40 mA											
Display elements	2 yellow LEDs											
Control input MF	Teach-in; Reset											
Switching outputs	Q: PNP											
	Q: NPN											
	invertable ³⁾											
	invertable ³⁾											
Analogue output, invertable ³⁾	$Q_A: 4 \dots 20 \text{ mA}$											
	$Q_A: 0 \dots 10 \text{ V}$											
Response time	32 ms											
Switching frequency	15/s											
Switching hysteresis	2.0 mm ± 10 %											
Temperature compensation												
Synchronisation option												
Functional display												
ObSB-mode ⁴⁾												
Standby delay	< 300 ms											
Connection type	Plug M12, 5-pin											
Enclosure rating	IP 67											
Ambient temperature	Operating -25 °C ... +70 °C											
	Storage -40 °C ... +85 °C											
Weight	65 g approx.											
Housing material⁵⁾	Nickel-plated brass											

¹⁾ Limit values
²⁾ Without load

³⁾ Outputs short-circuit protected
 $I_{max} = 200 \text{ mA}$
 PNP: High = $V_s - (< 2 \text{ V})$ / LOW = 0 V
 NPN: High = V_s / LOW ≤ 2 V

⁴⁾ Object between sensor and background
⁵⁾ Plastic parts: PBT
 Ultrasonic transducer: Polyurethane-foam, glass epoxy resin

Detection ranges

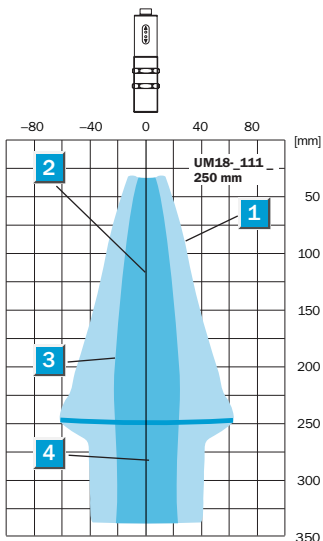

- 1 Aligned plate 500 x 500 mm²
- 2 Tube diameter 10 mm
- 3 Operating distance
- 4 Maximum scanning distance

Order information

Type	Order no..
UM18-51111	6028965
UM18-51112	6028964
UM18-51114	6028973
UM18-51115	6028974
UM18-11116	6029507
UM18-11117	6029508

	Operating scanning distance
	20 ... 150 mm 55 ... 250 mm
Ultrasonic sensor	

- Independent of material shape (including films, glass and bottles)
- Teach-in
- Insensitive to dirt, dust and fog
- 1 switching output PNP/NPN
- Very good background suppression (BGS)



Dimensional drawing

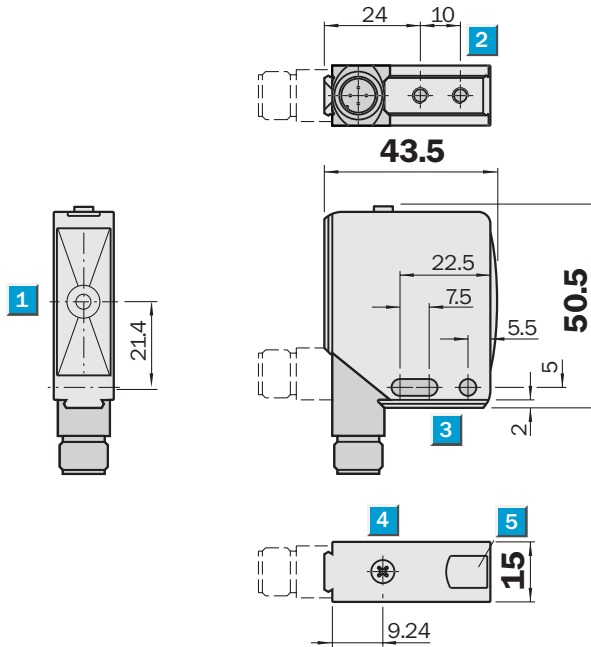

Adjustments possible

All types

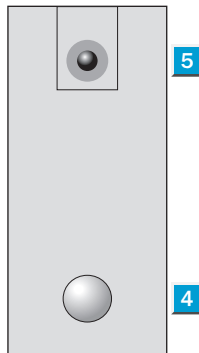

- 1 Centre of sender and receiver axis
- 2 M4 threaded mounting hole – 4 mm deep
- 3 Mounting hole \varnothing 4,2 mm
- 4 Control element(s)
- 5 Signal strength indicator

Connection type

All types

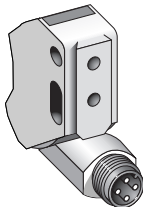

4-pin, M12

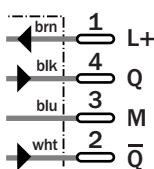

Accessories
Mounting systems



Technical data		UC12-	11231	12231	12235	12235						
Operating scanning distance	20 ... 150 mm (250 mm)											
(limiting scanning distance)	55 ... 250 mm (350 mm)											
Ultrasonic frequency	Approx. 380 kHz											
	Approx. 500 kHz											
Resolution	0.18 mm											
Reproducibility	typ. ± 0.15 % of final value											
Accuracy	≤ 2 % of final value											
Supply voltage V_s	10 ... 30 V DC											
Residual ripple	10 %											
Current consumption	≤ 40 mA											
Switching output ²⁾	Q: PNP											
	Q: NPN											
Response time	27 ms											
Switching frequency	< 25 /s											
Switching hysteresis	2.0 mm											
Standby delay	< 300 ms											
Indicator	Double-LED green/yellow											
Control element(s)	Teach-in button											
Connection type	Plug M12, 4-pin											
VDE protection class	II											
Temperature compensation	Yes											
Enclosure rating	IP 67											
Ambient temperature	Operation -20 °C ... $+70$ °C											
	Storage -40 °C ... $+85$ °C											
Weight	Approx. 75 g											
Housing material ³⁾	Nickel-plated brass											

¹⁾ Outputs short-circuit protected
 $I_{\text{max}} = 200$ mA
 PNP: High = $V_s - (< 2 \text{ V})$ /LOW = 0 V
 NPN: High = V_s /LOW ≤ 2 V

²⁾ Temperature compensation
 at -20 ... $+65$ °C

³⁾ Ultrasonic transducer: Polyurethane-
 foam, glass epoxy resin

Measurement ranges

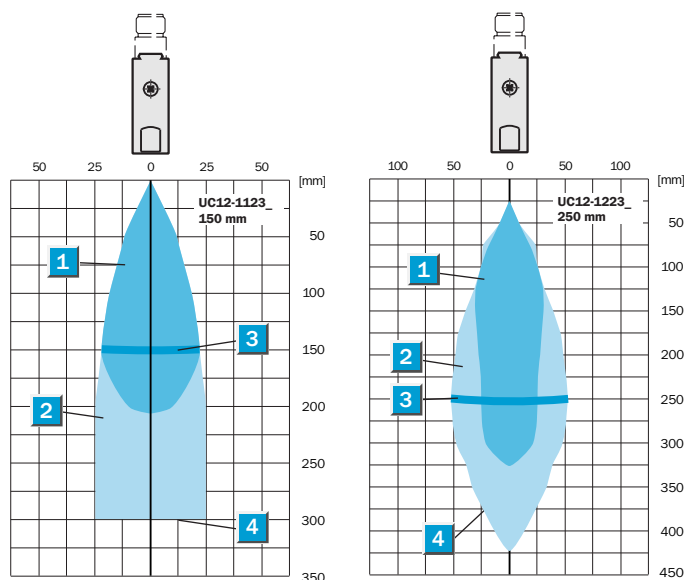

- | | |
|---|---------------------------------------|
| 1 | Aligned plate 10 x 10 mm ² |
| 2 | Pipe diameter 10 mm |
| 3 | Operating scanning distance |
| 4 | Limiting scanning distance |

Order information

Type	Order no.
UC12-11231	6029831
UC12-12231	6029832
UC12-11235	6029833
UC12-12235	6029834

 **Operational area**
40 mm ± 3 mm

Ultrasonic double-sheet detector

- Double-sheet detection of foils, metal sheets and ultra-fine corrugated cardboards
- Automatic adjustment, no Teach-in necessary
- Colour-independent
- Plug & Play
- 2 PNP outputs for double- and mis-fed-sheets

Dimensional drawing

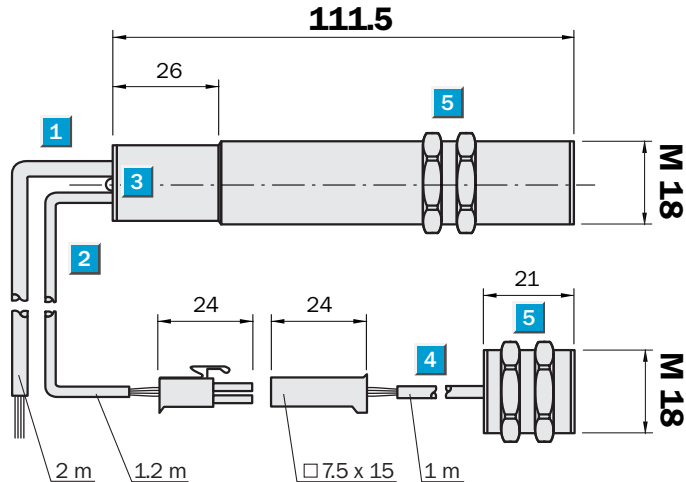

Adjustments possible

UM18-20012

- 1 Connection cable 2 m (receiver)
- 2 Connection cable 1.2 m, 2-pin sender and receiver
- 3 2-color LED indicator, receiver
- 4 Connection cable 1 m, 2-pin sender and receiver
- 5 Fastening nuts, width across 24 mm

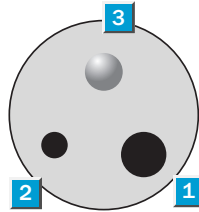

Connection types

UM18-20012*)

Receiver

Sender

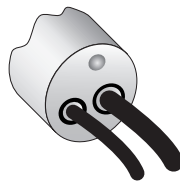

5 x 0.25 mm²

2-pin

2-pin

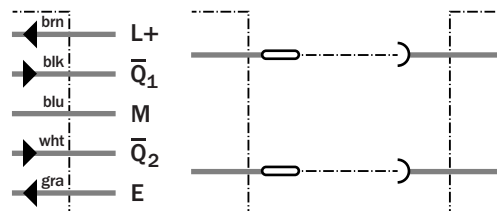

*) Sender/receiver pair:
Individual components on request



Accessories
Mounting systems

Technical data	UM18-	20012											
----------------	-------	-------	--	--	--	--	--	--	--	--	--	--	--

Installation distance

sender – receiver	40 mm ± 3 mm	
Blind zone	7 mm, each time before sender and receiver	
Permissible angle deviation	± 45° perpendicular to sheet	
Ultrasonic frequency	400 kHz	
Resolution	Double-sheets not completely glued together	

Operational area

Paper grams per square meter	20 ... 1200 g/m ²	
Metal-laminated sheets and films	≤ 0.4 mm thickness	
Self-adhesive films, metal sheets	≤ 0.3 mm	
Ultra-fine corrugated cardboard		

Supply voltage V_s	20 ... 30 V DC ¹⁾	
Ripple	± 10 %	

Current consumption ²⁾	≤ 45 mA	
-----------------------------------	---------	--

Double-sheet switching/Q₁ ³⁾	Q ₁ : PNP, V _s -2 V, I _{max} = 500 mA	
---	--	--

Mis-fed-sheet switching output/Q₂ ³⁾	Q ₂ : PNP, V _s -2 V, I _{max} = 500 mA	
---	--	--

Response time ⁴⁾	2.5 ms or 6.5 ms	
-----------------------------	------------------	--

Off delay	10 ms	
-----------	-------	--

V _s at control unit ⁴⁾	Response time 6.5 ms: V _s > 9 V DC Response time 2.5 ms: V _s < 5 V DC	
--	--	--

Standby delay	300 ms	
---------------	--------	--

Connection type	Cable PVC, 2 m; 5 x 0.25 mm ²	
------------------------	--	--

Sender cable ⁵⁾	PVC, 1.2 m with 2-pin plug	
----------------------------	----------------------------	--

Receiver cable ⁵⁾	PVC, 1 m with 2-pin plug	
------------------------------	--------------------------	--

Enclosure rating	IP 65	
-------------------------	-------	--

Ambient temperature	Operation +5 °C ... +60 °C Storage -40 °C ... +85 °C	
----------------------------	---	--

Weight	280 g	
---------------	-------	--

Housing material	Nickel-plated brass	
-------------------------	---------------------	--

¹⁾ Limit values

²⁾ Without load

³⁾ Outputs short-circuit protected, Opener; no switching hysteresis

⁴⁾ If the control line is laid against a ground, the response time is 2.5 ms. If the control line is laid against L+, the response time is 6.5 ms.

⁵⁾ Not reverse-polarity protected

Measurement ranges

Order information

Type	Order no.
UM18-20012	6025670

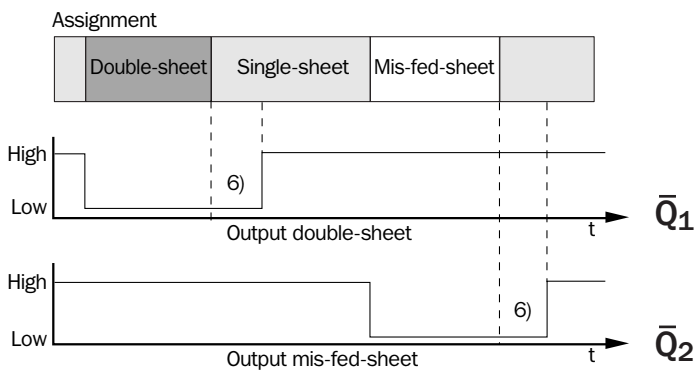

⁶⁾ Off delay

Dimensional drawings and order informations

SENSICK screw-in system M12, 5-pin, enclosure rating IP 67

- Contact assignment according to EN 50 044
- DC coding

Pin assignment
 Pin 1 = brown
 Pin 2 = white
 Pin 3 = blue
 Pin 4 = black
 Pin 5 = grey

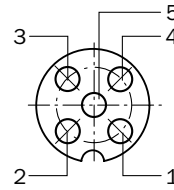

Female connector M12, 5-pin, straight

Type	Order no.	Contacts
DOS-1205-G	6009719	5

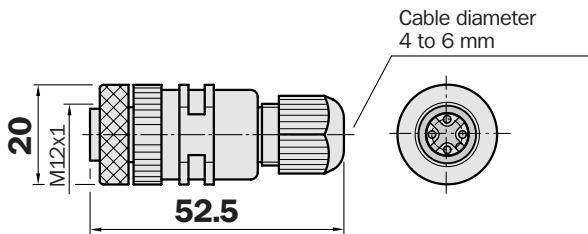

Female connector M12, 5-pin, right angle

Type	Order no.	Contacts
DOS-1205-W	6009720	5

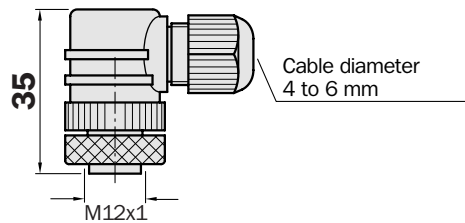
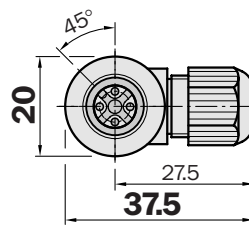

Female connector M12, 5-pin, straight

Cable diameter 6 mm, 5 x 0.25 mm², sheath PVC

Type	Order no.	Contacts	Cable length
DOL-1205-G02M	6008899	5	2 m
DOL-1205-G05M	6009868	5	5 m
DOL-1205-G10M	6010544	5	10 m

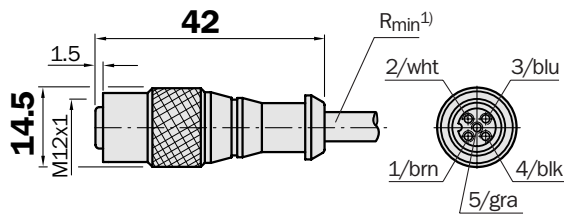

Female connector M12, 5-pin, right angle

Cable diameter 6 mm, 5 x 0.25 mm², sheath PVC

Type	Order no.	Contacts	Cable length
DOL-1205-W02M	6008900	5	2 m
DOL-1205-W05M	6009869	5	5 m
DOL-1205-W10M	6010542	5	10 m

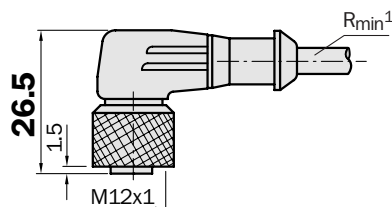
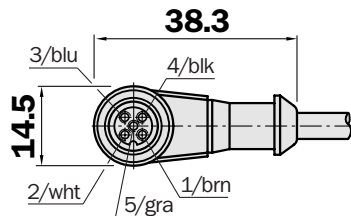

Dimensional drawings and order informations

Mounting bracket for UM18

Type	Order no.
BEF-WN-M18	5308446

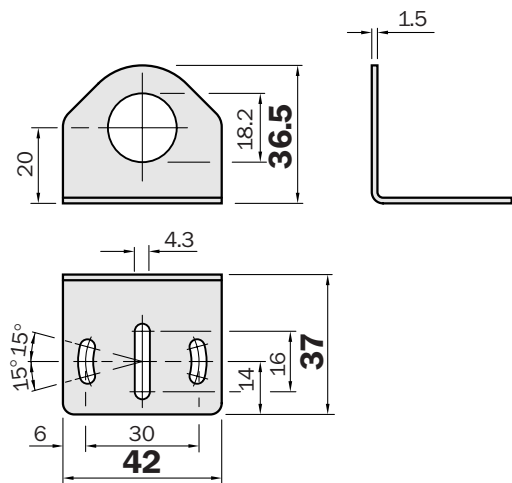

Mounting bracket for UM30

Type	Order no.
BEF-WN-M30	5308445

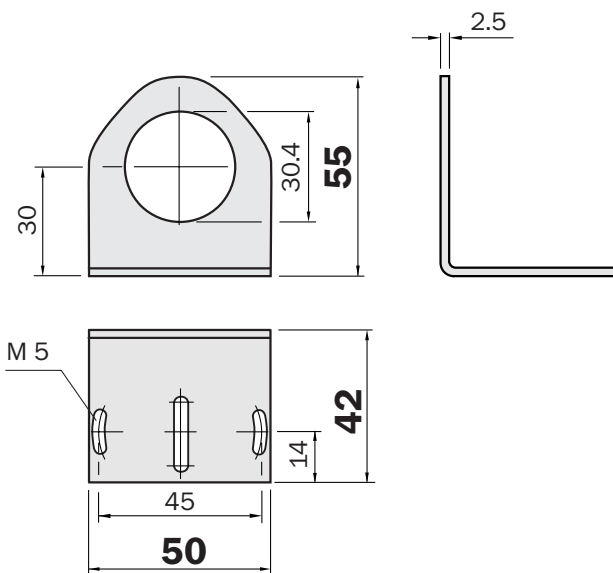

Diverter plate for UM30 to 1300 mm operating scanning range

Type	Order no.
USP-UM30	5312916

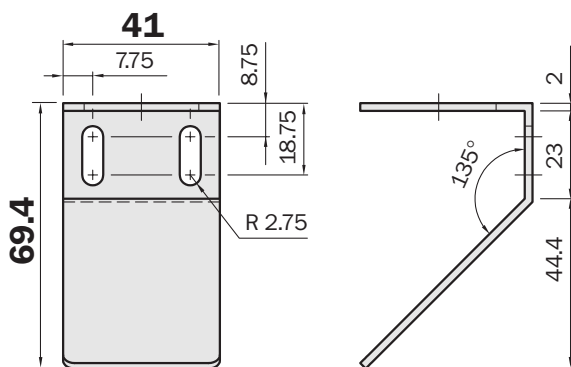

Australia

Phone +61 3 9497 4100
1800 33 48 02 - tollfree
E-Mail sales@sick.com.au

Belgium/Luxembourg

Phone +32 (0)2 466 55 66
E-Mail info@sick.be

Brasil

Phone +55 11 5091-4900
E-Mail sac@sick.com.br

Ceská Republika

Phone +420 2 57 91 18 50
E-Mail sick@sick.cz

China

Phone +852-2763 6966
E-Mail ghk@sick.com.hk

Danmark

Phone +45 45 82 64 00
E-Mail sick@sick.dk

Deutschland

Phone +49 (0)2 11 53 01-250
E-Mail info@sick.de

España

Phone +34 93 480 31 00
E-Mail info@sick.es

France

Phone +33 1 64 62 35 00
E-Mail info@sick.fr

Great Britain

Phone +44 (0)1727 831121
E-Mail info@sick.co.uk

India

Phone +91-22-2822 7084
E-Mail info@sick-india.com

Italia

Phone +39 02 27 40 93 19
E-Mail info@sick.it

Japan

Phone +81 (0)3 3358 1341
E-Mail info@sick.jp

Nederlands

Phone +31 (0)30 229 25 44
E-Mail info@sick.nl

Norge

Phone +47 67 81 50 00
E-Mail austefjord@sick.no

Österreich

Phone +43 (0)22 36 62 28 8-0
E-Mail office@sick.at

Polska

Phone +48 22 837 40 50
E-Mail info@sick.pl

Republic of Korea

Phone +82-2 786 6321/4
E-Mail kang@sickkorea.net

Republika Slovenija

Phone +386 (0)1-47 69 990
E-Mail office@sick.si

Russia

Phone +7 95 775 05 30
E-Mail info@sick-automation.ru

Schweiz

Phone +41 41 619 29 39
E-Mail contact@sick.ch

Singapore

Phone +65 6744 3732
E-Mail admin@sicksgp.com.sg

Suomi

Phone +358-9-25 15 800
E-Mail sick@sick.fi

Sverige

Phone +46 8 680 64 50
E-Mail info@sick.se

Taiwan

Phone +886 2 2365-6292
E-Mail sickgrc@ms6.hinet.net

Türkiye

Phone +90 216 388 95 90 pbx
E-Mail info@sick.com.tr

USA/Canada/México

Phone +1(952) 941-6780
1 800-325-7425 - tollfree
E-Mail info@sickusa.com

More representatives and agencies
in all major industrial nations at
www.sick.com