

## -30V P-Channel Enhancement Mode MOSFET

### ■ DESCRIPTION

The UM3403 is the P-Channel logic enhancement mode power field effect transistor is produced using high cell density advanced trench technology..

This high density process is especially tailored to minimize on-state resistance. These devices are particularly suited for low voltage application, and low in-line power loss are needed in a very small outline surface mount package.

### ■ FEATURE

- ◆ -30V/-2.6A,  $R_{DS(ON)}=88m\Omega$  (typ.)@ $V_{GS}=-10V$
- ◆ -30V/-2.0A,  $R_{DS(ON)}=103m\Omega$  (typ.)@ $V_{GS}=-4.5V$
- ◆ -30V/-1.0A,  $R_{DS(ON)}=139m\Omega$  (typ.)@ $V_{GS}=-2.5V$
- ◆ Super high design for extremely low  $R_{DS(ON)}$
- ◆ Exceptional on-resistance and Maximum DC current capability
- ◆ Full RoHS compliance
- ◆ SOT23-3L package design

### ■ APPLICATIONS

- ◆ Power Management
- ◆ Portable Equipment
- ◆ DC/DC Converter
- ◆ Load Switch
- ◆ DSC
- ◆ LCD Display inverter

### ■ PIN CONFIGURATION

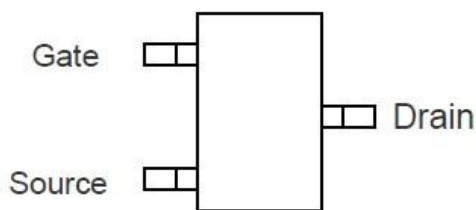

TOP VIEW  
SOT-23

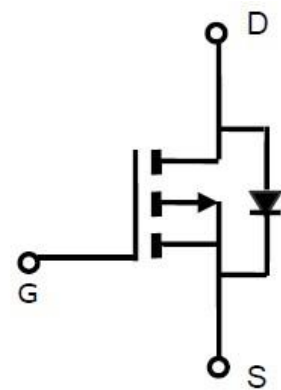

P-Channel

## ■ PART NUMBER INFORMATION

UM3403A-BB C	A= Package Code S: SOT23-3L BB=Handing Code TR: Tape&Reel C=Lead Plating Code G: Green Product
--------------	---

## ■ ORDERING INFROMATION

Part Number	Package Code	Package	Shipping
UM3403S-TRG	S	SOT23-3L	3000EA / T&R

- ※ Year Code : 0~9
- ※ Week Code : A~Z(1-26); a~z(27~52)
- ※ G : Green Product. This product is RoHS compliant.

## ■ ABSOLUTE MAXIMUM RATINGS ( $T_A = 25^\circ\text{C}$ Unless otherwise noted )

Symbol	Parameter	Typical	Unit
$V_{DSS}$	Drain-Source Voltage	-30	V
$V_{GSS}$	Gate-Source Voltage	$\pm 12$	V
$I_D$	Continuous Drain Current ( $T_C=25^\circ\text{C}$ )	-2.6	A
	Continuous Drain Current ( $T_J=70^\circ\text{C}$ )		
$I_{DM}$	Pulsed Drain Current	-13	A
$I_S$	Continuous Source Current (Diode Conduction)	-1.5	A
$P_D$	Power Dissipation	$T_A=25^\circ\text{C}$	W
		$T_A=70^\circ\text{C}$	
$T_J$	Operation Junction Temperature	150	$^\circ\text{C}$
$T_{STG}$	Storage Temperature Range	-55~+150	$^\circ\text{C}$
$R_{\theta JA}$	Thermal Resistance Junction to Ambient	120	$^\circ\text{C}/\text{W}$

**Note: Absolute maximum ratings are those values beyond which the device could be permanently damaged. Absolute maximum ratings are stress rating only and functional device operation is not implied**

■ **ELECTRICAL CHARACTERISTICS** ( $T_A=25^\circ\text{C}$  Unless otherwise noted)

Symbol	Parameter	Condition	Min	Typ	Max	Unit
<b>Static Parameters</b>						
$V_{(BR)DSS}$	Drain-Source Breakdown Voltage	$V_{GS}=0V, I_D=-250\mu A$	-30			V
$V_{GS(th)}$	Gate Threshold Voltage	$V_{DS}=V_{GS}, I_D=-250\mu A$	-0.6		-1.2	V
$I_{GSS}$	Gate Leakage Current	$V_{DS}=0V, V_{GS}=\pm 12V$			$\pm 100$	nA
$I_{DSS}$	Zero Gate Voltage Drain Current	$V_{DS}=-24V, V_{GS}=0$			-1	uA
		$V_{DS}=-24V, V_{GS}=0$ $T_J=55^\circ\text{C}$			-5	
$R_{DS(ON)}$	Drain-Source On-Resistance	$V_{GS}=-10V, I_D=-4.3A$		44	52	m $\Omega$
		$V_{GS}=-4.5V, I_D=-3.5A$		50	58	
		$V_{GS}=-2.5V, I_D=-2.5A$		65	78	
<b>Source-Drain Diode</b>						
$V_{SD}$	Diode Forward Voltage	$I_S=-1.0A, V_{GS}=0V$		-0.7	-1.0	V
<b>Dynamic Parameters</b>						
$Q_g$	Total Gate Charge	$V_{DS}=-20V$ $V_{GS}=-4.5V$ $I_D=-4.0A$		6.2		nC
$Q_{gs}$	Gate-Source Charge			2.8		
$Q_{gd}$	Gate-Drain Charge			3.0		
$C_{iss}$	Input Capacitance	$V_{DS}=-12V$ $V_{GS}=0V$ $f=1\text{MHz}$		672		pF
$C_{oss}$	Output Capacitance			280		
$C_{riss}$	Reverse Transfer Capacitance			102		
$T_{d(on)}$	Turn-On Time	$V_{DS}=-12V$ $I_D=-4A$		9		nS
$T_r$				15		
$T_{d(off)}$	Turn-Off Time	$V_{GEN}=-10V$ $R_G=3.3\Omega$		23		
$T_f$				21		

**Note: 1. Pulse test: pulse width $\leq$ 300uS, duty cycle $\leq$ 2%**

**2.Static parameters are based on package level with recommended wire bonding**

■ **TYPICAL CHARACTERISTICS** (25°C Unless Note)

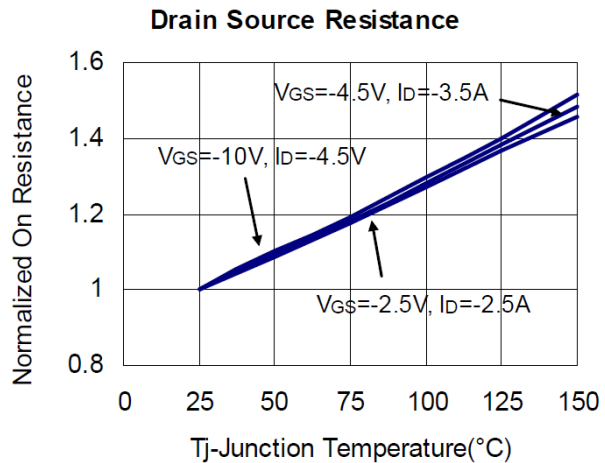
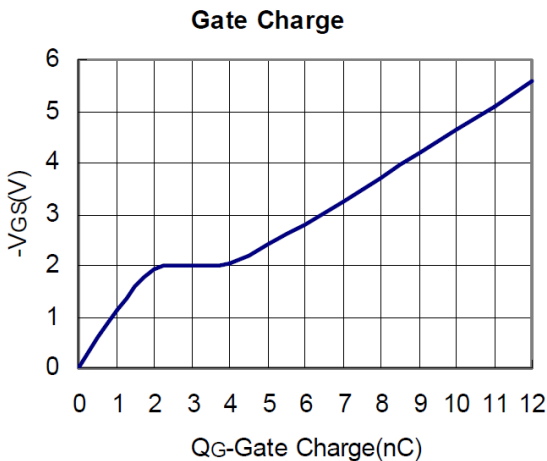
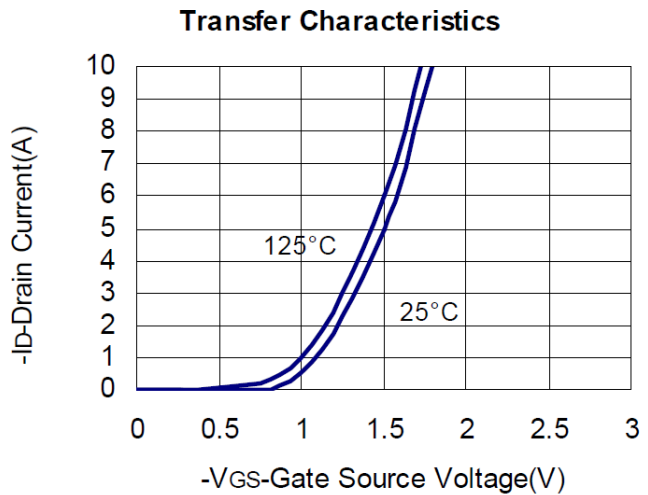
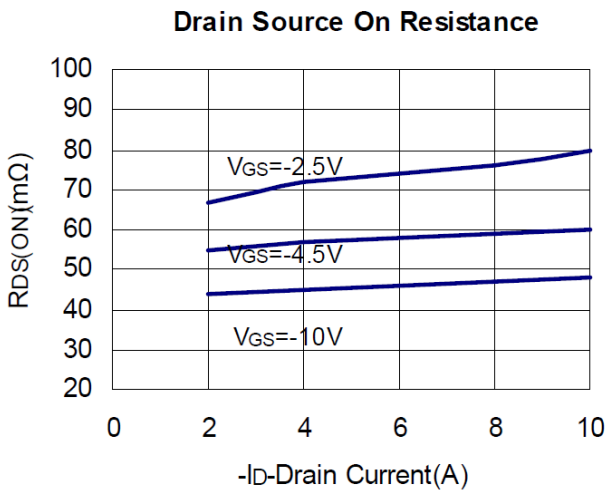
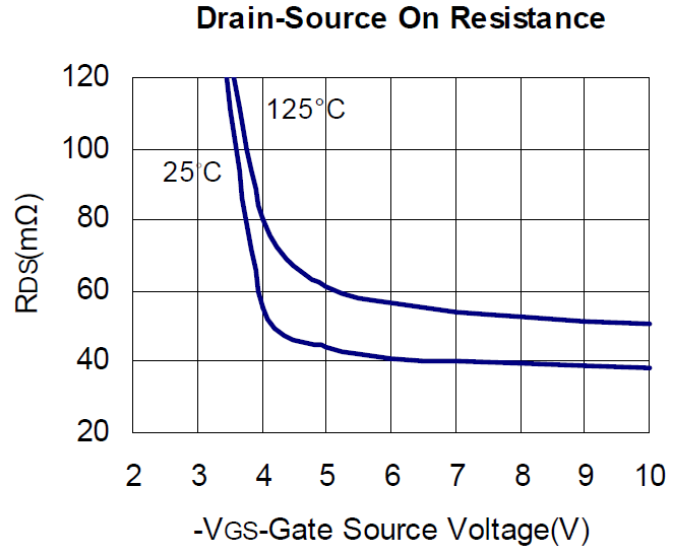
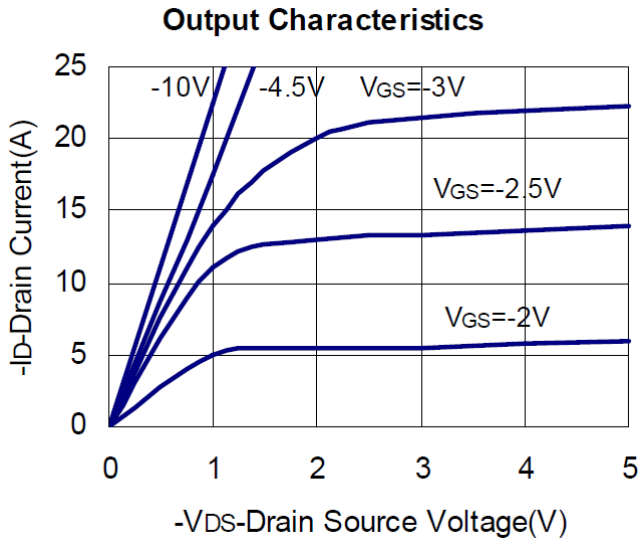

## ■ TYPICAL CHARACTERISTICS (continuous)

### Capacitance

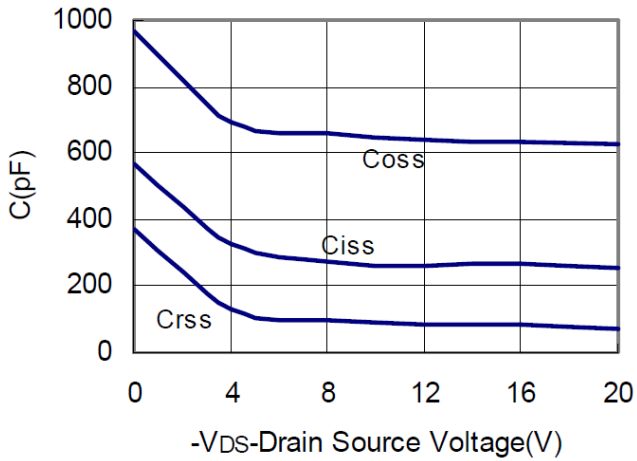

### Source Drain Diode Forward

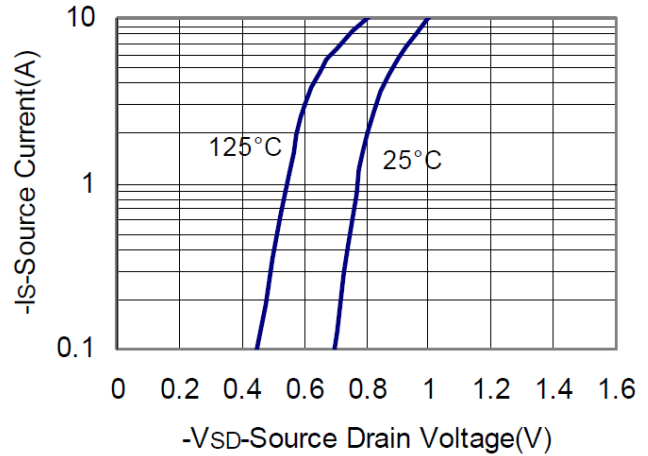

### Power Dissipation

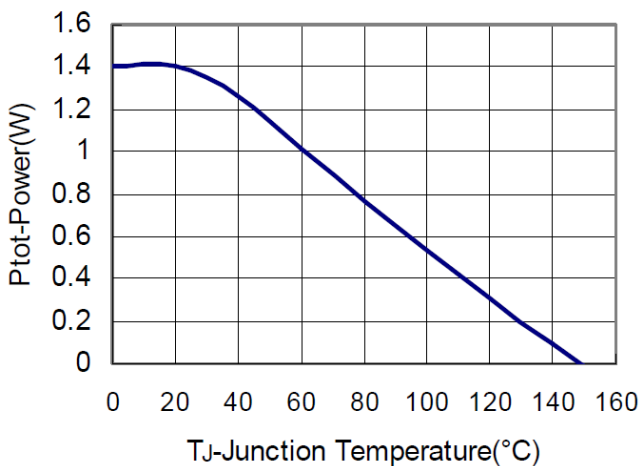

### Drain Current

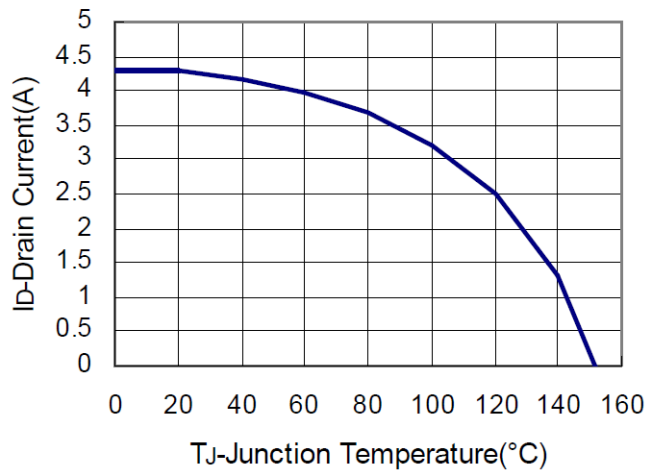

### Thermal Transient Impedance

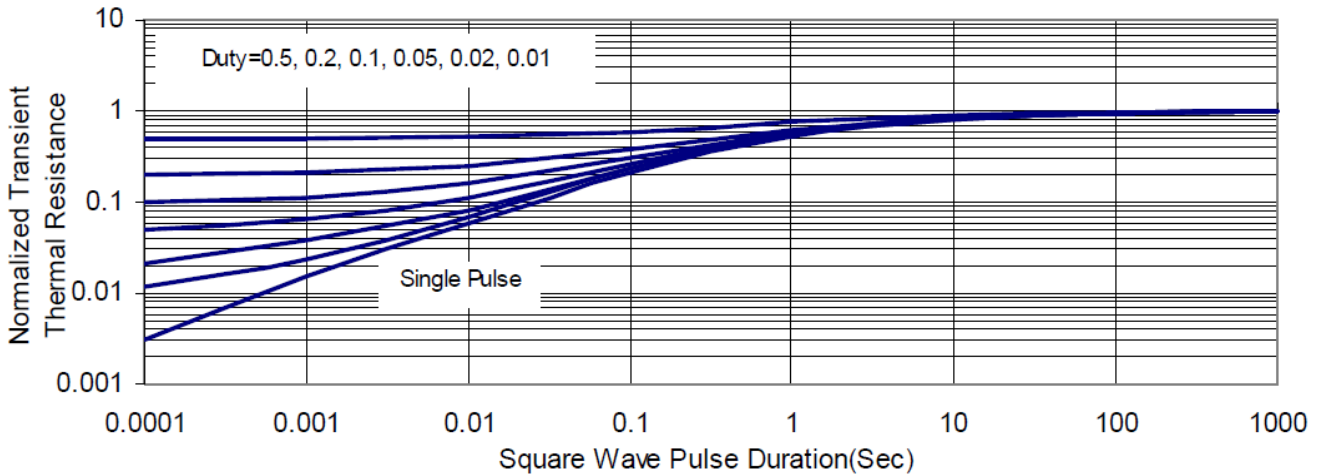

## ■ SOT23-3L PACKAGE OUTLINE DIMENSIONS

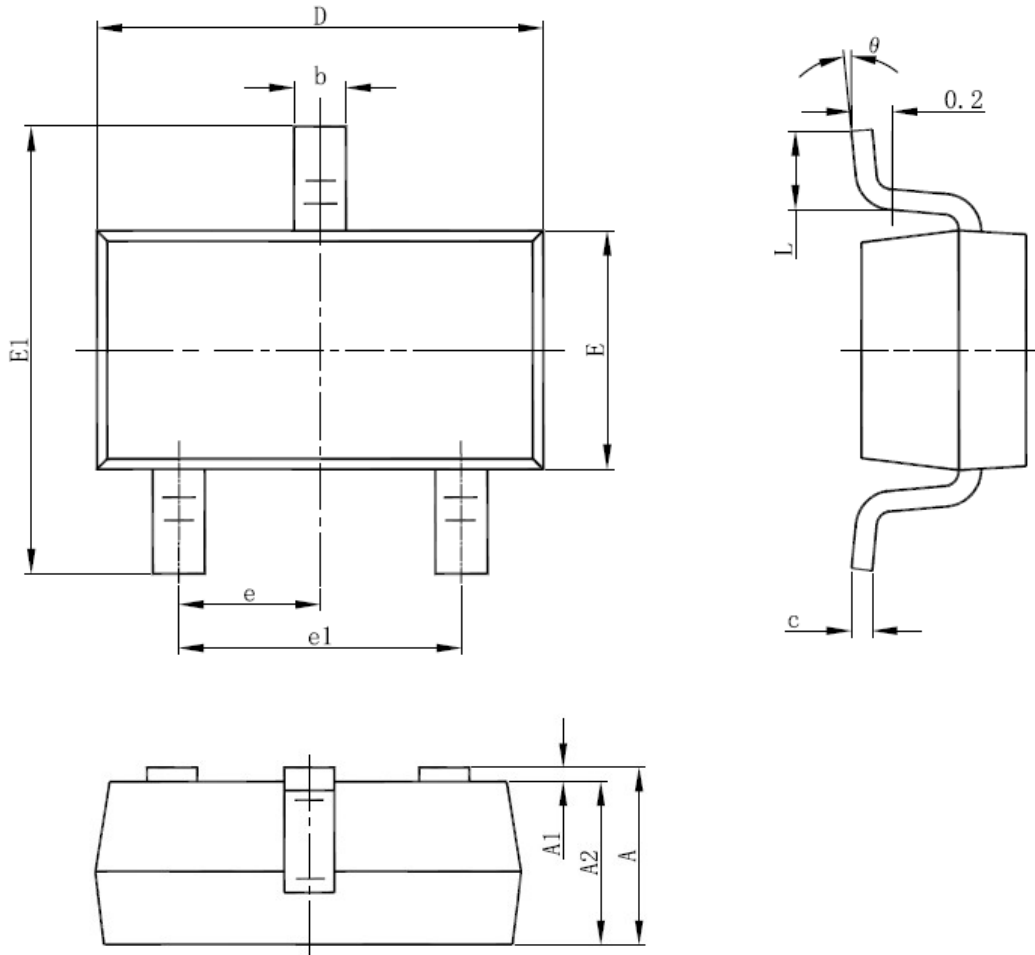

Symbol	Dimensions In Millimeters		Dimensions In Inches	
	Min	Max	Min	Max
A	1.050	1.250	0.041	0.049
A1	0.000	0.100	0.000	0.004
A2	1.050	1.150	0.041	0.045
b	0.300	0.500	0.012	0.020
c	0.100	0.200	0.004	0.008
D	2.820	3.020	0.111	0.119
E	1.500	1.700	0.059	0.067
E1	2.650	2.950	0.104	0.116
e	0.950(BSC)		0.037(BSC)	
e1	1.800	2.000	0.071	0.079
L	0.300	0.600	0.012	0.024
θ	0°	8°	0°	8°

## ■ SOLDERING METHODS FOR UNIVERCHIP

Storage environment Temperature=10°C~35°C Humidity=65%±15%

Reflow soldering of surface mount device

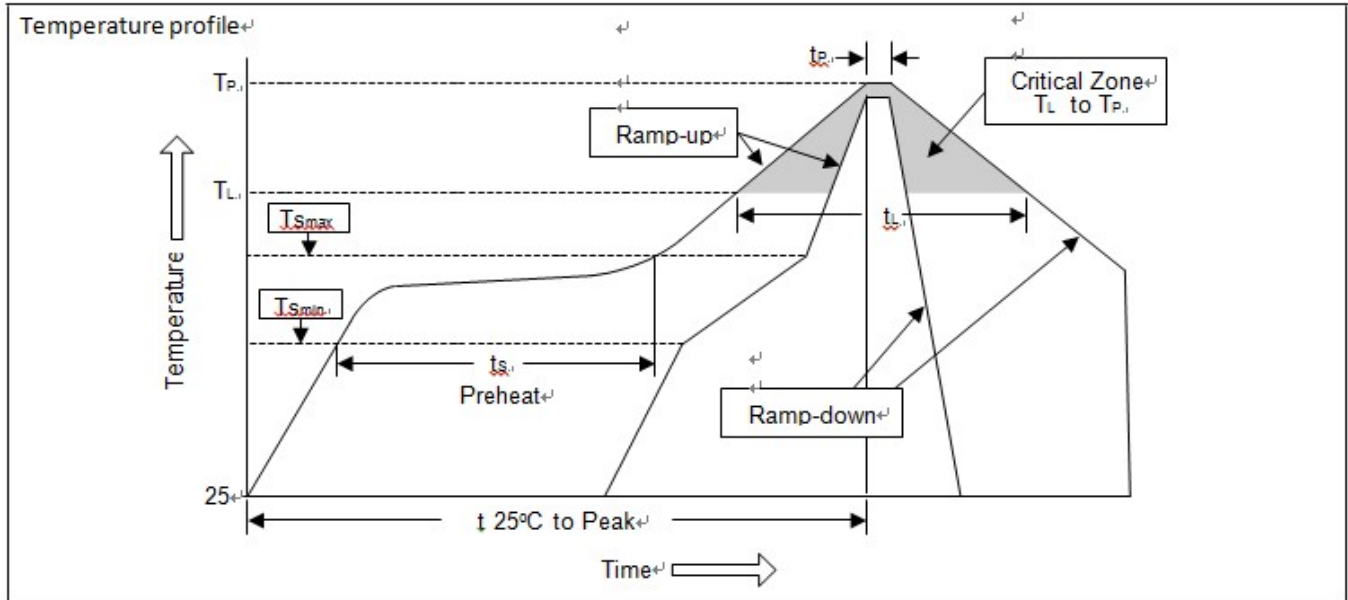

Profile Feature	Sn-Pb Eutectic Assembly	Pb free Assembly
Average ramp-up rate ( $T_L$ to $T_P$ )	<3°C/sec	<3°C/sec
Preheat		
-Temperature Min ( $T_{smin}$ )	100°C	150°C
-Temperature Max ( $T_{smax}$ )	150°C	200°C
-Time (min to max) ( $t_s$ )	60~120 sec	60~180 sec
$T_{smax}$ to $T_L$		
-Ramp-up Rate	<3°C/sec	<3°C/sec
Time maintained above		
-Temperature ( $T_L$ )	183°C	217°C
-Time ( $t_L$ )	60~150 sec	60~150 sec
Peak Temperature ( $T_P$ )	240°C+0/-5°C	260°C+0/-5°C
Time within 5°C of actual Peak Temperature ( $t_p$ )	10~30 sec	20~40 sec
Ramp-down Rate	<6°C/sec	<6°C/sec
Time 25°C to Peak Temperature	<6 minutes	<6 minutes

Flow (wave) soldering (solder dipping)

Product	Peak Temperature	Dipping Time
Pb device	245°C±5°C	5sec±1sec
Pb-Free device	260°C+0/-5°C	5sec±1sec



This integrated circuit can be damaged by ESD UniverChip Corporation recommends that all integrated circuits be handled with appropriate precautions. Failure to observe proper handling and installation procedure can cause damage. ESD damage can range from subtle performance degradation to complete device failure. Precision integrated circuits may be more susceptible to damage because very small parametric changes could cause the device not to meet its published specifications.