

600mA, 1.2MHz, Synchronous Step-Down DC-DC Converter

UM3501 SOT23-5

UM3501DA DFN6L 2.0×2.0

General Description

UM3501 is a high-efficiency pulse-width-modulated (PWM) step-down DC-DC converter, capable of delivering 600mA output current over a wide input voltage range from 2.5V to 5.5V. The target application of UM3501 is for portable electronic devices that are powered from 1-cell Li-ion battery or from other power sources within the range such as cellular phones, PDAs and handy-terminals. Internal synchronous rectifier with low $R_{DS(ON)}$ dramatically reduces conduction loss at PWM mode. No external Schottky diode is required in practical application. The UM3501 automatically turns off the synchronous rectifier while the inductor current is low and enters discontinuous PWM mode. This can increase efficiency at light load condition.

UM3501 enter shutdown mode and consumes less than 0.1uA when EN pin is pulled low. The operation frequency is set to 1.2MHz. This along with small SOT23-5 package and DFN6L 2.0×2.0 package provides small PCB area application. Other features include lower internal reference voltage with 2% accuracy, over temperature protection, and over current protection.

Applications

- Cellular and Smart Phones
- Microprocessors and DSP Core Supplies
- Wireless and DSL Modems
- PDAs, GPS
- MP3 Player
- Portable Instruments

Features

- High Efficiency: Up to 90%
- 1.2MHz Constant Switching Frequency
- 600mA Output Current
- Integrated Main Switch and Synchronous Rectifier. No Schottky Diode Required
- 2.5V to 5.5V Input Voltage Range
- Low Quiescent Current: 50μA
- Thermal Fault Protection
- <1μA Shutdown Current
- Lead Free SOT23-5 Package and DFN6L 2.0×2.0 Package

Typical Application Circuit

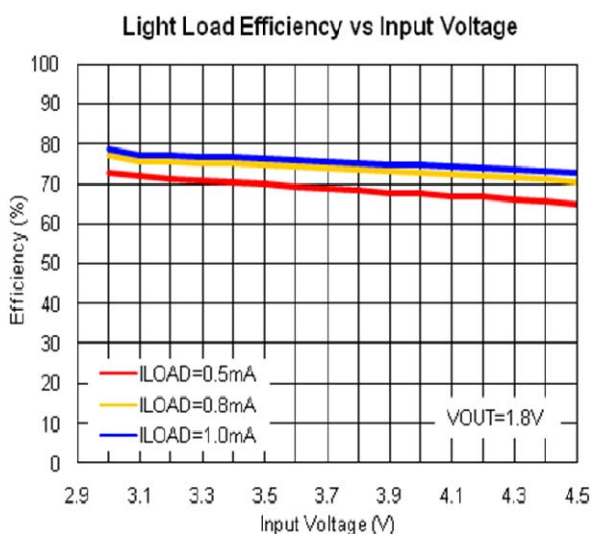
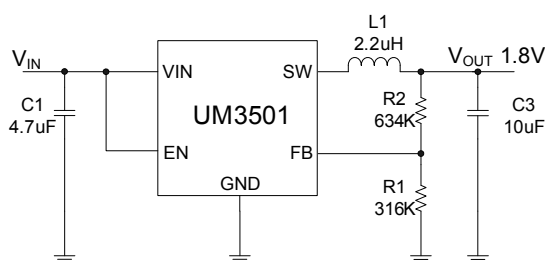

Pin Configurations

Top View

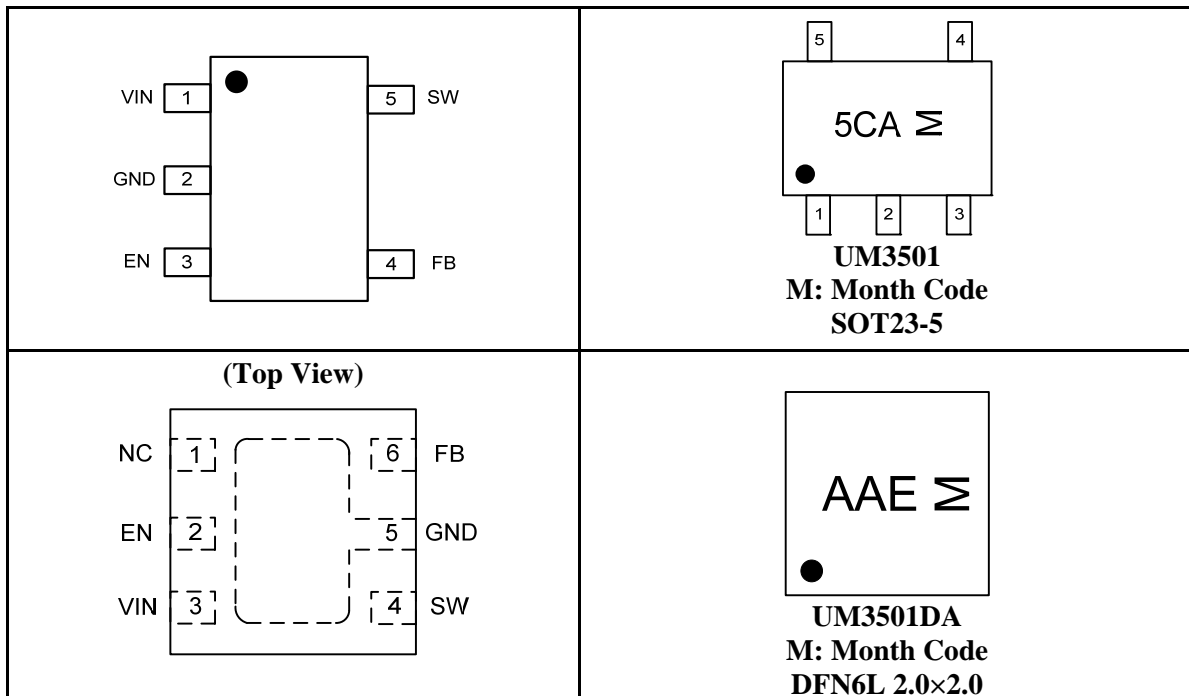

Pin Description

Pin Number		Symbol	Function
SOT23-5	DFN6L 2.0×2.0		
1	3	VIN	Supply input pin. Must be closely decoupled to GND, Pin2, with a 4.7μF or greater ceramic capacitor.
2	5	GND	Ground.
3	2	EN	Regulator enable control input. Drive EN above 1.0V to turn on the part. Drive EN below 0.4V to turn it off. In shutdown, all functions are disabled drawing <1μA supply current. Do not leave EN floating.
4	6	FB	Feedback input pin. Connect FB to the center point of the external resistor divider.
5	4	SW	Power switch output. It is the switch node connection to Inductor. This pin connects to the drains of the internal P-CH and N-CH MOSFET switches.
-	1	NC	Not connected.

Ordering Information

Part Number	Packaging Type	Marking Code	Shipping Qty
UM3501	SOT23-5	5CA	3000pcs/7Inch Tape & Reel
UM3501DA	DFN6L 2.0×2.0	AAE	3000pcs/7Inch Tape & Reel

Absolute Maximum Ratings (Note 1)

Symbol	Parameter	Value	Unit	
V_{IN}	Input Voltage	-0.3 to +6.0	V	
V_{EN}, V_{FB}	EN, FB Voltages	-0.3 to $V_{IN}+0.3$	V	
V_{SW}	SW Voltage	-0.3 to $V_{IN}+0.3$	V	
I_{SW}	Peak SW Sink and Source Current	1.5	A	
P_D	Continuous Power Dissipation at $T_A=25^\circ\text{C}$	SOT23-5	0.89	W
		DFN6L 2.0×2.0	1.56	
T_O	Operating Temperature	-40 to +85	$^\circ\text{C}$	
T_{STG}	Storage Temperature Range	-65 to +150	$^\circ\text{C}$	

Note 1: Stresses greater than those listed under Maximum Ratings may cause permanent damage to the device. This is a stress rating only and functional operation of the device at these or any other conditions above those indicated in the operational sections of this specification is not implied. Exposure to absolute maximum rating conditions for extended periods may affect reliability.

Electrical Characteristics (Note 2)

($V_{IN}=V_{EN}=3.6\text{V}$, $T_A=+25^\circ\text{C}$, unless otherwise noted)

Symbol	Parameter	Test Conditions	Min	Typ	Max	Unit
V_{IN}	Input Voltage Range		2.5		5.5	V
I_Q (Active)	Input DC Supply Current (Active Mode)	$V_{FB}=0.6\text{V}$, $I_{LOAD}=0\text{A}$		50		μA
I_Q (Shutdown)	Input DC Supply Current (Shutdown Mode)	$V_{FB}=0\text{V}$, $V_{IN}=4.2\text{V}$		0.08	1.0	μA
V_{FB}	Regulated Feedback Voltage	$T_A=+25^\circ\text{C}$	0.5880	0.6000	0.6120	V
		$0^\circ\text{C}\leq T_A\leq 85^\circ\text{C}$	0.5865	0.6000	0.6135	
		$-40^\circ\text{C}\leq T_A\leq 85^\circ\text{C}$	0.5850	0.6000	0.6150	
I_{FB}	FB Input Bias Current	$V_{FB}=0.65\text{V}$			± 30	nA
	Reference Voltage Line Regulation	$2.5\text{V}\leq V_{IN}\leq 5.5\text{V}$, $V_{OUT}=V_{FB}$ ($R_2=0$)		0.11	0.40	%/V
	Output Voltage Line Regulation	$2.5\text{V}\leq V_{IN}\leq 5.5\text{V}$, $I_{OUT}=10\text{mA}$		0.11	0.40	%/V
	Output Voltage Load Regulation	$100\text{mA}\leq I_{OUT}\leq 600\text{mA}$		0.0015		%/mA
$I_{O(max)}$	Maximum Output Current	$V_{IN}=3.6\text{V}$, $V_{OUT}=1.8\text{V}$	600			mA
f	Oscillator Frequency	$V_{FB}=0.6\text{V}$ or $V_{OUT}=100\%$		1.2		MHz
$R_{DS(ON)}$	$R_{DS(ON)}$ of P-CH MOSFET	$V_{IN}=3.6\text{V}$, $I_{SW}=100\text{mA}$		0.40	0.50	Ω
	$R_{DS(ON)}$ of N-CH MOSFET	$V_{IN}=3.6$, $I_{SW}=-100\text{mA}$		0.35	0.45	Ω
I_P	Peak Inductor Current	$V_{IN}=3.0\text{V}$, $V_{FB}=0.5\text{V}$ or $V_{OUT}=90\%$, Duty Cycle<35%	0.90	1.20	1.90	A

Electrical Characteristics (Continued)

($V_{IN}=V_{EN}=3.6V$, $T_A=+25^{\circ}C$, unless otherwise noted)

Symbol	Parameter	Test Conditions	Min	Typ	Max	Unit
I_{SWL}	SW Leakage	$V_{EN}=0V$, $V_{IN}=5V$, $V_{SW}=0V$ or $5V$		± 0.01	± 1	μA
V_H	EN High-Level Threshold	$-40^{\circ}C \leq T_A \leq 85^{\circ}C$	1.0			V
V_L	EN Low-Level Threshold	$-40^{\circ}C \leq T_A \leq 85^{\circ}C$			0.4	V
I_{ENL}	EN Leakage Current			± 0.1	± 1	μA
$\eta_{(max)}$	Max. Efficiency	$V_{IN}=3.6V$, $V_{OUT}=2.5V$		90		%
	Thermal Shutdown Temperature			160		$^{\circ}C$

Note 2: 100% production test at $+25^{\circ}C$. Specifications over the temperature range are guaranteed by design and characterization.

Typical Performance Characteristics

($V_{IN}=3.6V$, $V_{OUT}=1.8V$, $L1=2.2\mu H$, $C1=4.7\mu F$, $C3=10\mu F$, $T_A=+25^{\circ}C$, unless otherwise noted.)

Efficiency vs. Load Current

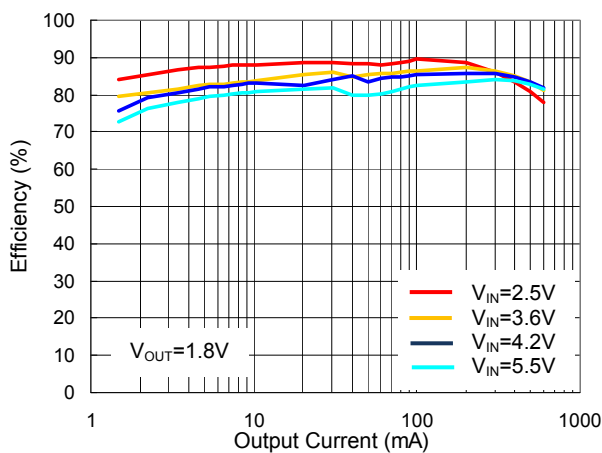

Efficiency vs. Load Current

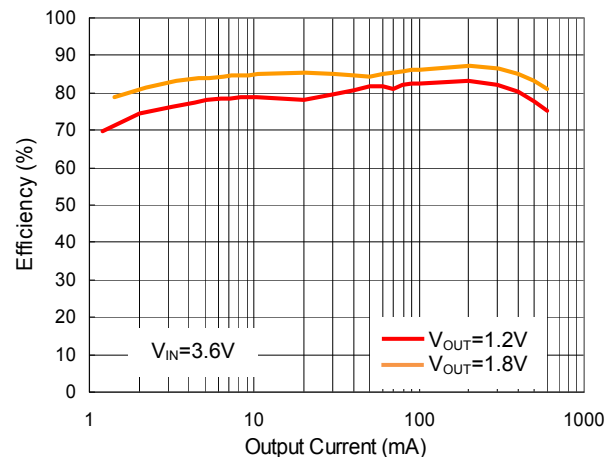

Efficiency vs. Input Voltage

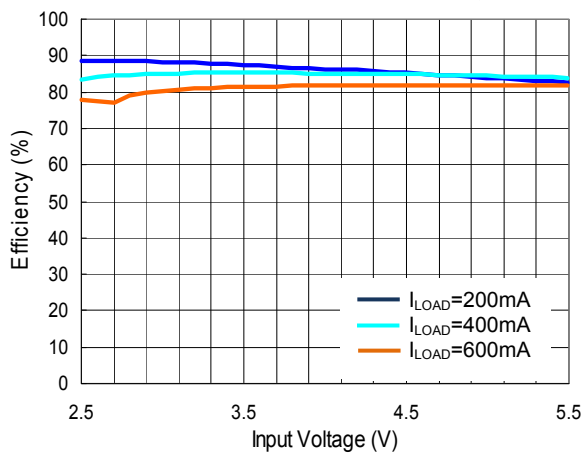

Output Voltage vs. Load Current

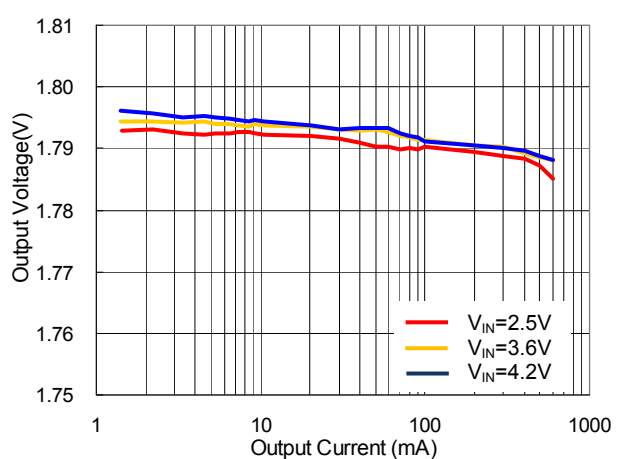

Typical Performance Characteristics (Continued)

($V_{IN}=3.6V$, $V_{OUT}=1.8V$, $L1=2.2\mu H$, $C1=4.7\mu F$, $C3=10\mu F$, $T_A=+25^\circ C$, unless otherwise noted.)

Output Voltage vs. Input Voltage

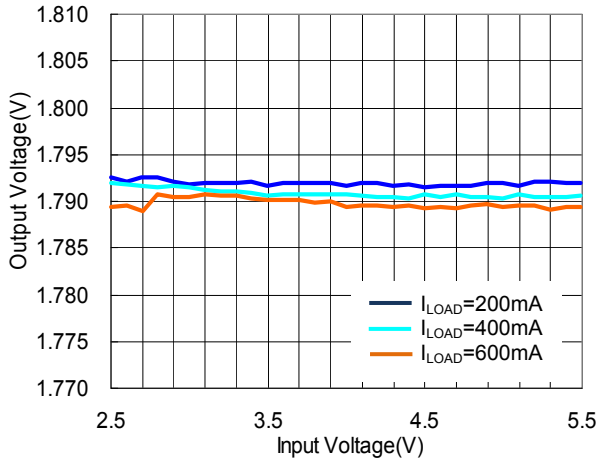

Output Voltage vs. Temperature

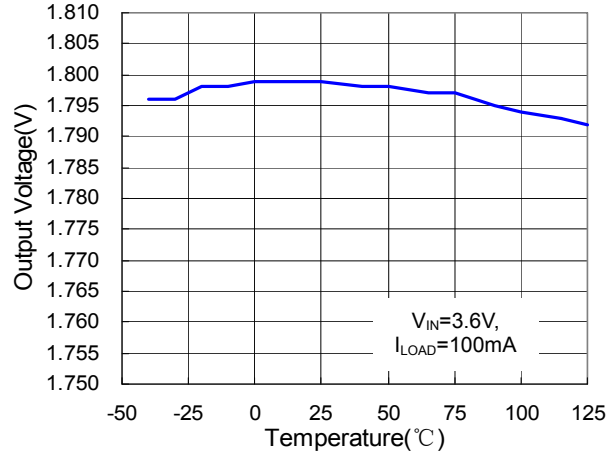

Supply Current vs. Input Voltage

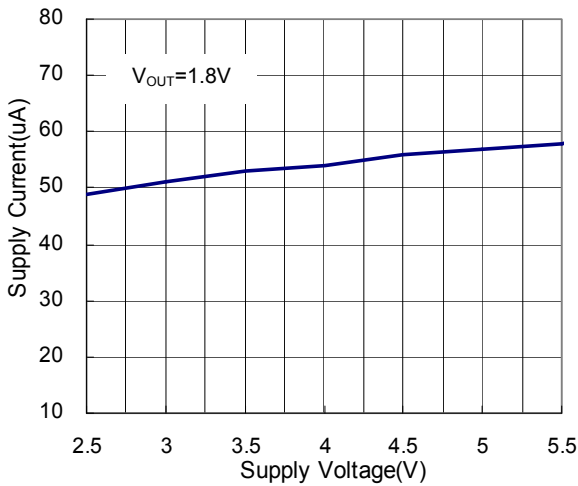

Frequency vs. Input Voltage

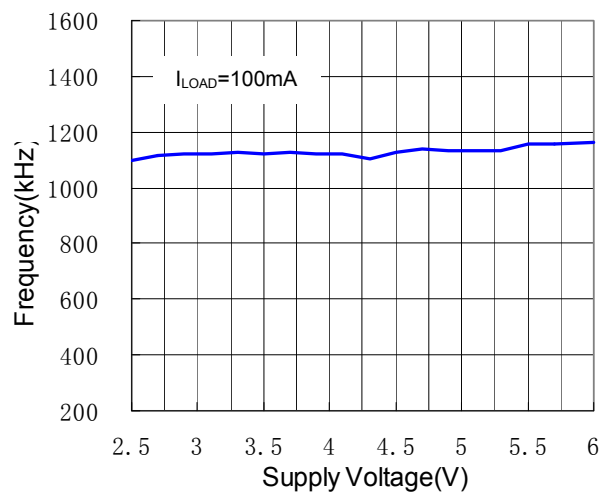

Line Transient Response ($V_{OUT}=1.8V$, $I_{OUT}=300mA$)

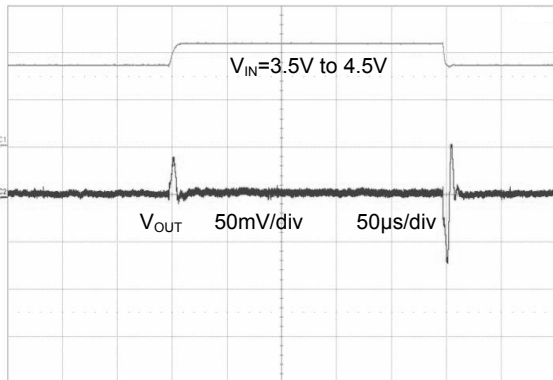

Load Transient Response ($V_{IN}=3.6V$, $V_{OUT}=1.8V$)

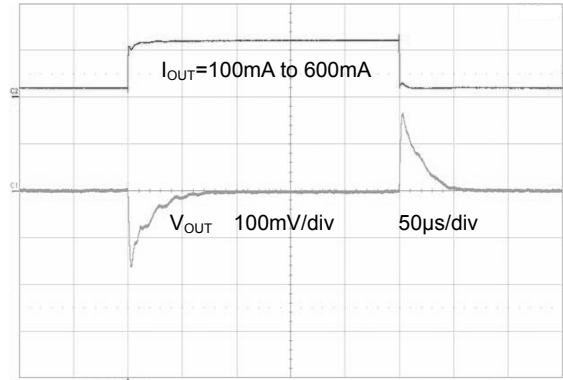

Typical Performance Characteristics (Continued)

($V_{IN}=3.6V$, $V_{OUT}=1.8V$, $L1=2.2\mu H$, $C1=4.7\mu F$, $C3=10\mu F$, $T_A=+25^\circ C$, unless otherwise noted.)

Light Load Operation
($V_{OUT}=1.8V$, $I_{OUT}=0mA$)

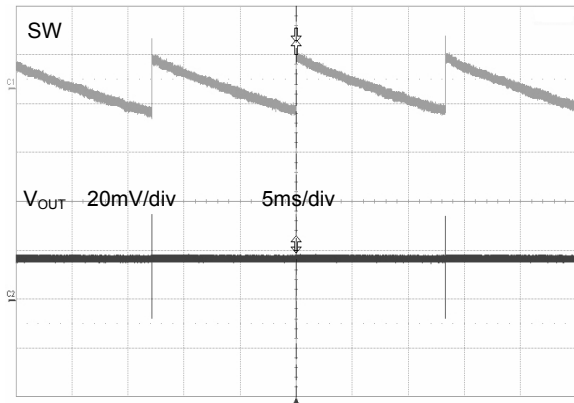

Heavy Load Operation
($V_{OUT}=1.8V$, $I_{OUT}=200mA$)

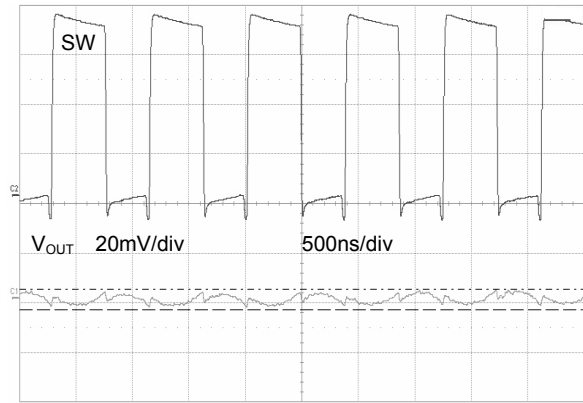

Block Diagram

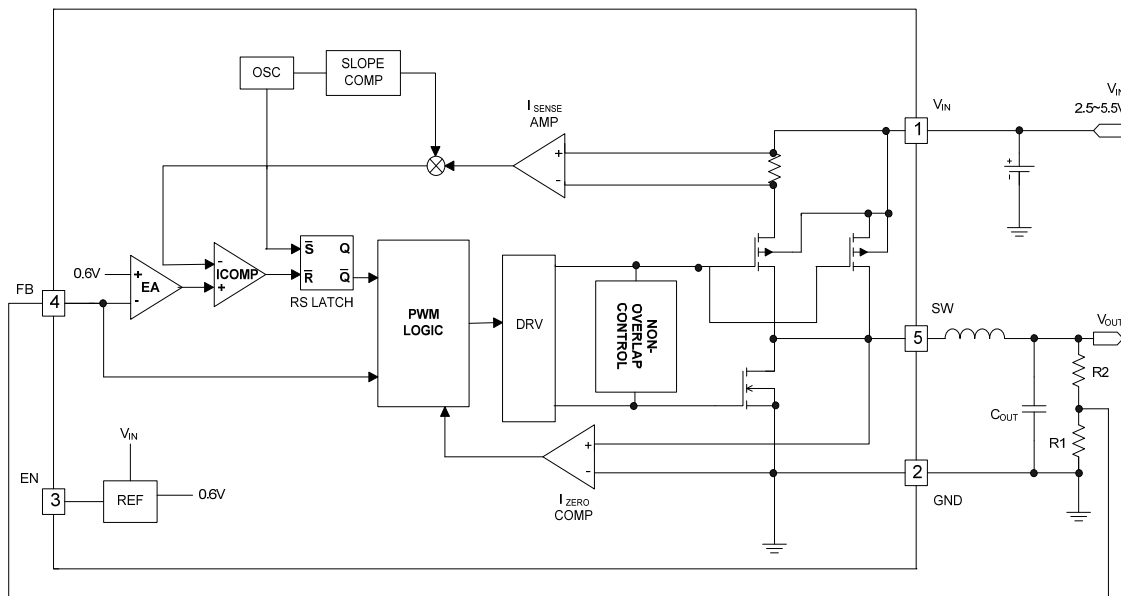

Function Description

UM3501 is a monolithic switching mode step-down DC-DC converter. It utilizes internal MOSFETs to achieve high efficiency and can generate very low output voltage by using internal reference at 0.6V. It operates at a fixed switching frequency, and uses the slope compensated current mode architecture. This step-down DC-DC converter supplies 600mA output current at $V_{IN}=3.6V$ with input voltage range from 2.5V to 5.5V.

Current Mode PWM Control and Current Limit

The UM3501 uses constant frequency, current mode step-down architecture. Both the main (P-channel MOSFET) and synchronous (N-channel MOSFET) switches are internal. From the block diagram, a comparator ICOMP is used to realize current limit protection. Lossless current sensing converts the peak current signal to a voltage to sum in with the internal slope compensation. This summed signal is compared to the error amplifier output to provide a peak current control command for the PWM. The cycle-by-cycle current limit is set at 1200mA (typical). During normal operation, the internal top power MOSFET is turned on each cycle when the oscillator sets the RS latch, and turned off when the current comparator ICOMP, resets the RS latch. The peak inductor current at which ICOMP resets the RS latch, is controlled by the output of error amplifier EA. When the load current increases, it causes a slight decrease in the feedback voltage, FB, relative to the 0.6V reference, which in turn, causes the EA amplifier's output voltage to increase until the average inductor current matches the new load current. While the top MOSFET is off, the bottom MOSFET is turned on until either the inductor current starts to reverse, as indicated by the current reversal comparator I_{ZERO} , or the beginning of the next clock cycle.

When the output is shorted to ground, the inductor current may exceed the maximum inductor peak current if not allowed enough time to decay. To prevent the inductor current from running away, the bottom N-channel MOSFET is allowed to stay on for more than one cycle, thereby allowing the inductor current time to decay.

Pulse Skipping Mode Operation

At very light loads, the UM3501 automatically enters Pulse Skipping Mode. In the Pulse Skipping Mode, the inductor current may reach zero or reverse on each pulse. The PWM control loop will automatically skip pulses to maintain output regulation. The bottom MOSFET is turned off by the current reversal comparator, I_{ZERO} , and the switch voltage will ring. This is discontinuous mode operation, and is normal behavior for the switching regulator.

Maximum Load Current

The UM3501 will operate with input supply voltage as low as 2.5V, however, the maximum load current decreases at lower input due to large IR drop on the main switch and synchronous rectifier. The slope compensation signal reduces the peak inductor current as a function of the duty cycle to prevent sub-harmonic oscillations at duty cycles greater than 50%. Conversely the current limit increases as the duty cycle decreases.

Applications Information

Output Voltage Setting

The external resistor divider sets the output voltage. The feedback resistor R2 also sets the feedback loop bandwidth with the internal compensation capacitor.

Choose R2 around 600k Ω for optimal transient response and feedback leakage current. R1 is then given by:

$$R1 = \frac{R2}{\frac{V_{OUT}}{0.6V} - 1}$$

Inductor Selection

A 1 μ H to 10 μ H inductor with DC current rating at least 25% higher than the maximum load current is recommended for most applications. For best efficiency, the inductor DC resistance shall be <200m Ω .

For most designs, the inductance value can be derived from the following equation:

$$L = \frac{V_{OUT} \times (V_{IN} - V_{OUT})}{V_{IN} \times \Delta I_L \times f_{OSC}}$$

Where ΔI_L is the inductor ripple current. Choose inductor ripple current approximately 30% of the maximum load current, 600mA.

The maximum inductor peak current is:

$$I_{L(MAX)} = I_{LOAD} + \frac{\Delta I_L}{2}$$

Under light load conditions below 100mA, larger inductance is recommended for improved efficiency.

Input Capacitor Selection

The input capacitor reduces the surge current drawn from the input and switching noise from the device. The input capacitor impedance at the switching frequency shall be less than input source impedance to prevent high frequency switching current passing to the input. Ceramic capacitors with X5R or X7R dielectrics are highly recommended because of their low ESR and small temperature coefficients. For most applications, a 4.7 μ F capacitor is sufficient.

Output Capacitor Selection

The output capacitor keeps output voltage ripple small and ensures regulation loop stable. The output capacitor impedance shall be low at the switching frequency. Ceramic capacitor with X5R or X7R dielectrics are recommended. The output ripple ΔV_{OUT} is approximately:

$$\Delta V_{OUT} \leq \frac{V_{OUT} \times (V_{IN} - V_{OUT})}{V_{IN} \times f_{OSC} \times L} \times \left(ESR + \frac{1}{8 \times f_{OSC} \times C3} \right)$$

Layout Guidance

When laying out the PC board, the following suggestions should be taken to ensure proper operation of the UM3501.

1. The power traces, including the GND trace, the SW trace and the VIN trace should be kept short, direct and wide to allow large current flow.
2. Connect the input capacitor C1 to the VIN pin as closely as possible to get good power filter effect.
3. Keep the switching node, SW, away from the sensitive FB node.
4. Do not trace signal line under inductor.

Package Information

UM3501: SOT23-5

Outline Drawing

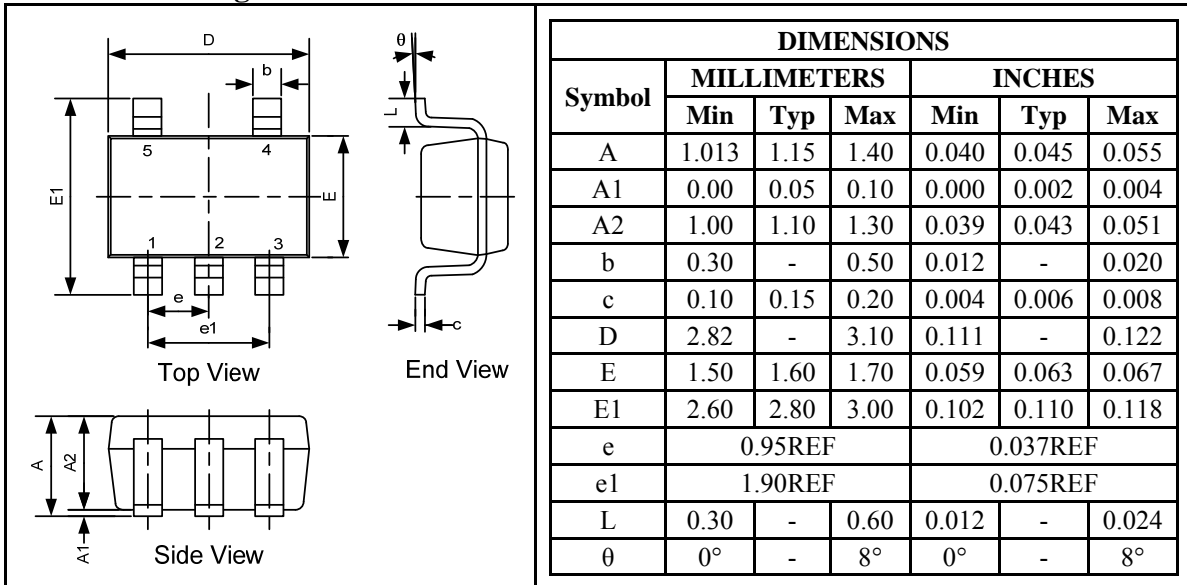

Land Pattern

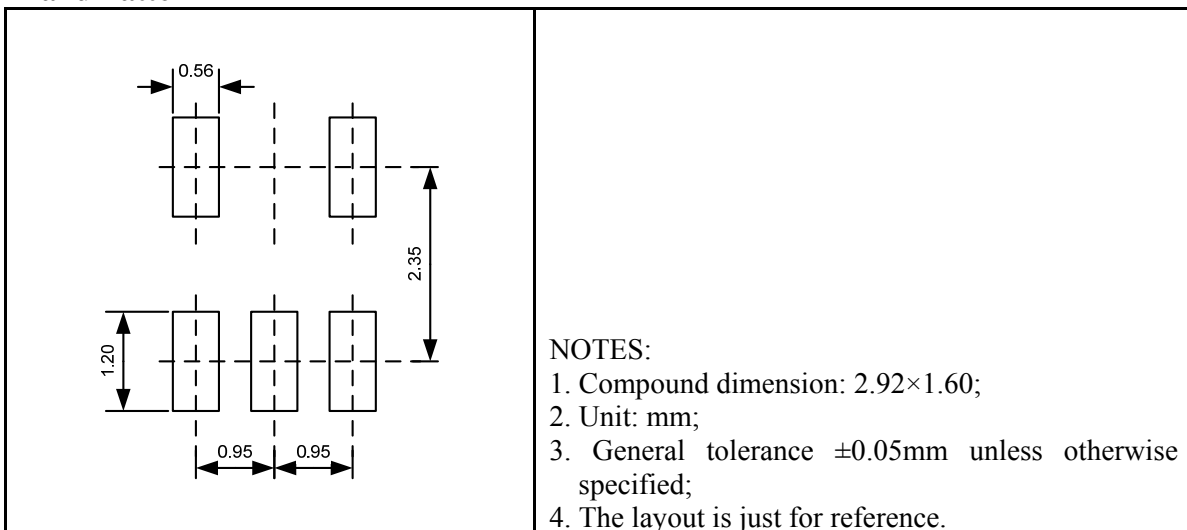

Tape and Reel Orientation

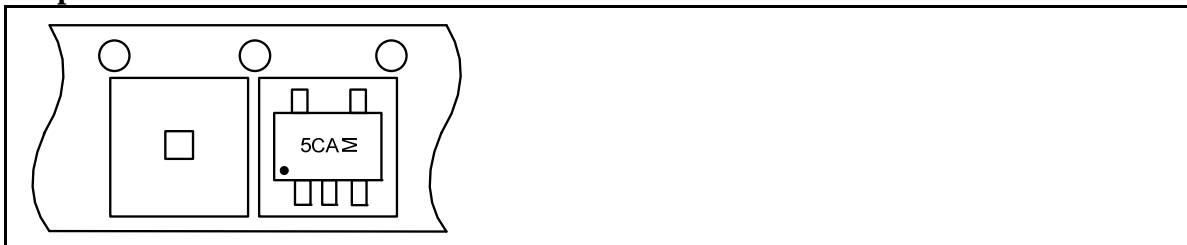

UM3501DA: DFN6L 2.0×2.0

Outline Drawing

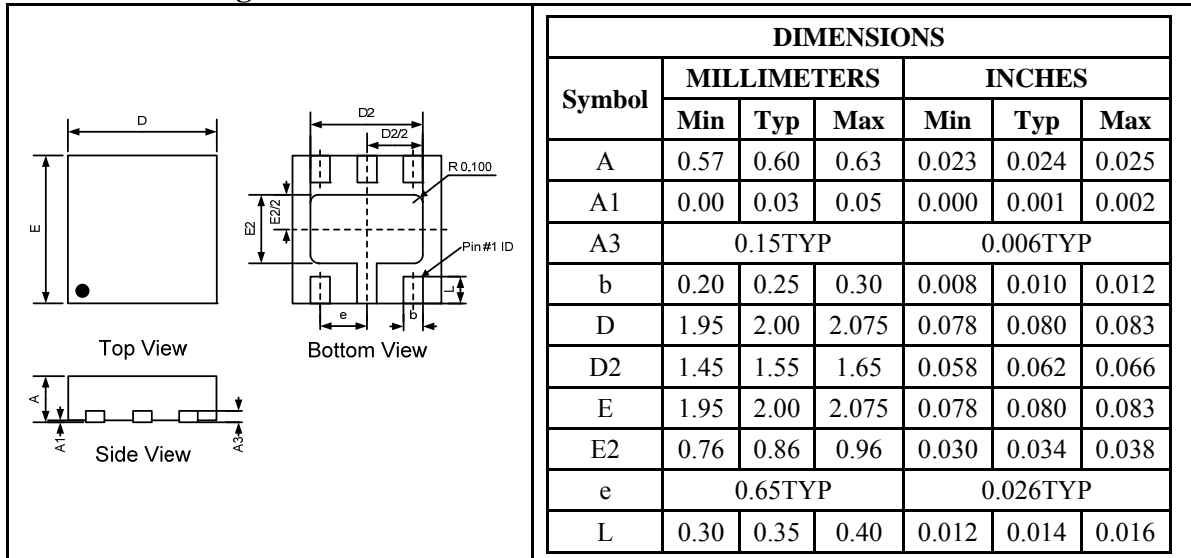

Land Pattern

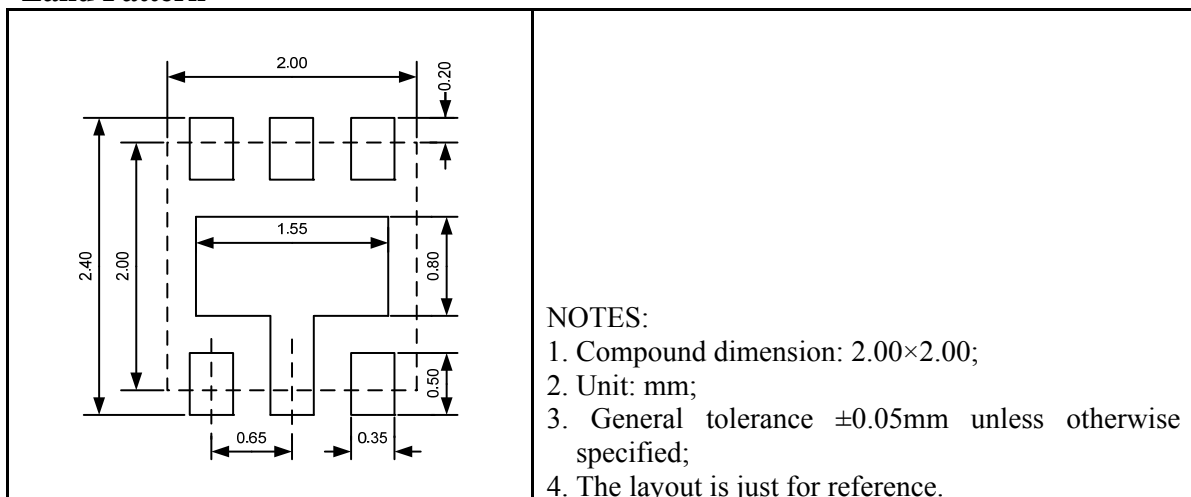

Tape and Reel Orientation



GREEN COMPLIANCE

Union Semiconductor is committed to environmental excellence in all aspects of its operations including meeting or exceeding regulatory requirements with respect to the use of hazardous substances. Numerous successful programs have been implemented to reduce the use of hazardous substances and/or emissions.

All Union components are compliant with the RoHS directive, which helps to support customers in their compliance with environmental directives. For more green compliance information, please visit:

http://www.union-ic.com/index.aspx?cat_code=RoHSDeclaration

IMPORTANT NOTICE

The information in this document has been carefully reviewed and is believed to be accurate. Nonetheless, this document is subject to change without notice. Union assumes no responsibility for any inaccuracies that may be contained in this document, and makes no commitment to update or to keep current the contained information, or to notify a person or organization of any update. Union reserves the right to make changes, at any time, in order to improve reliability, function or design and to attempt to supply the best product possible.



Union Semiconductor, Inc

Add: Unit 606, No.570 Shengxia Road, Shanghai 201210

Tel: 021-51093966

Fax: 021-51026018

Website: www.union-ic.com