

## 1A, 2.5V to 5.5V Input, Low Profile Power Module

### UM3503QA QFN24 4.0×4.0

#### General Description

The UM3503QA is a complete 1A, DC/DC step-down power supply intended for low-power applications. It is capable of delivering 1A output current over a wide input voltage range from 2.5V to 5.5V. Switching regulator, inductor and input/output capacitors are integrated into a tiny 4mm×4mm×1.05mm QFN package. Unless the external resistor divider, no additional components are required to accomplish the design. The UM3503QA is engineered to simplify design and to minimize layout constraints. It is ideal replacement of discrete buck converter to save PCB space.

The UM3503QA is based on a synchronous step-down DC-DC converter optimized for battery-powered portable applications. The DC/DC converter enters the pulse skipping mode automatically at light load condition. This can increase efficiency. The operation frequency is set to 2.25MHz at normal load condition. The UM3503QA enters shutdown mode and consumes less than 1μA when EN pin is pulled low.

The UM3503QA is available in a compact and low profile QFN24 4.0mm×4.0mm×1.05mm package.

#### Applications

- LDO Replacement
- FPGA and DSP Point-of-Load Regulator
- Cellular and Smart Phones
- MCU, DSP and FPGA Core Supplies
- Wireless and DSL Modems
- Portable Game Consoles and Instruments
- PDAs, GPS
- Bluetooth Headsets
- Battery-Powered Devices

#### Features

- Ultra Small QFN Package 4.0×4.0×1.05
- High Efficiency: Up to 90%
- 1A Output Current
- 0.6V Minimum Output Voltage
- 2.5V to 5.5V Input Voltage Range
- 2.25MHz Switching Frequency
- 56μA Quiescent Current
- <1μA Shutdown Current
- Excellent Load Transient and Line Transient
- Pulse Skipping Mode Operation
- Low Ripple at Light-Load Pulse Skipping Mode
- Thermal Fault Protection

#### Typical Application Circuit

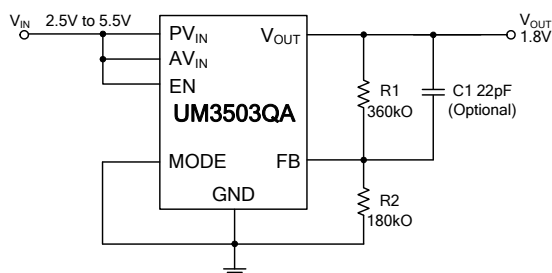

#### Light Load Efficiency

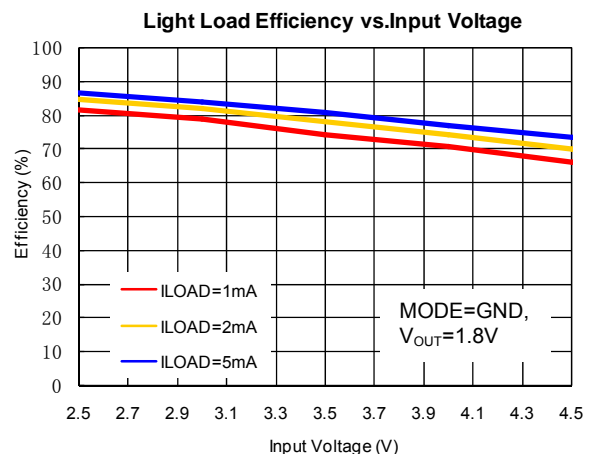

## Pin Configurations

## Top View

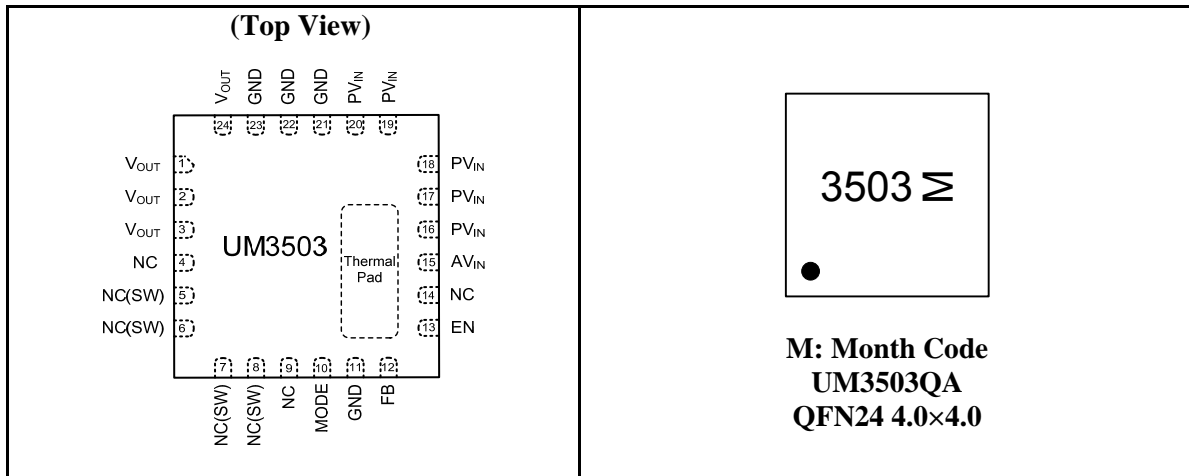

## Pin Description

Pin Number	Symbol	Function
1-3, 24	V <sub>OUT</sub>	Regulated output voltage. They have been connected together inside the chip.
4, 9, 14	NC	Not connected.
5-8	NC(SW)	Not connected—These pins are internally connected to the common switching node of the internal MOSFETs. NC(SW) pins are not to be electrically connected to any external signal, ground, or voltage. However, they must be soldered to the PCB.
10	MODE	MODE pin=high forces the device to operate in fixed-frequency PWM mode. Mode pin=low enables automatic transition from the pulse skipping mode to fixed-frequency PWM mode.
11, 21-23	GND	Ground. They have been connected together inside the chip.
12	FB	Feedback input pin. Connect FB to the center point of the external resistor divider.
13	EN	Regulator enable control input. Pulling this pin to high enables the device. Pulling this pin to low forces the device into shutdown mode. This pin must be terminated.
15	AV <sub>IN</sub>	Input power supply for the controller circuitry, usually connected to PV <sub>IN</sub> in the PCB or externally connected to V <sub>IN</sub> with a decouple capacitor alone.
16-20	PV <sub>IN</sub>	Input power supply for the MOSFET switches. They have been connected together inside the chip.
-	Thermal Pad	Connected to the ground plane by vias.

## Ordering Information

Part Number	Packaging Type	Marking Code	Shipping Qty
UM3503QA	QFN24 4.0×4.0	3503	3000pcs/13Inch Tape & Reel

## Absolute Maximum Ratings (Note 1)

Symbol	Parameter	Value	Unit
$V_{IN}, V_{OUT}$	Input and Output Voltages	-0.3 to +6.0	V
$V_{EN}, V_{FB}$	EN, FB Voltages	-0.3 to $V_{IN}+0.3$	V
$V_{SW}$	SW Voltage	-0.3 to $V_{IN}+0.3$	V
$I_O$	Peak Output Current	1.2	A
$P_D$	Continuous Power Dissipation at $T_A=25^{\circ}C$	2.31	W
$T_O$	Operating Temperature	-40 to +85	$^{\circ}C$
$T_{STG}$	Storage Temperature Range	-65 to +150	$^{\circ}C$
$T_{REFLOW}$	Reflow Temperature, MSL3 JEDEC J-STD-020C, 10 Sec	260	$^{\circ}C$

Note 1: Stresses greater than those listed under Maximum Ratings may cause permanent damage to the device. This is a stress rating only and functional operation of the device at these or any other conditions above those indicated in the operational sections of this specification is not implied. Exposure to absolute maximum rating conditions for extended periods may affect reliability.

## Recommended Operating Conditions

Symbol	Parameter	Min	Nom	Max	Unit	
$V_{IN}$	Input Voltage Range	2.5		5.5	V	
$V_{OUT}$	Output Voltage Range	1		5	V	
$I_O$	Output Current Range	0		1	A	
$C_{IN}$	Additional Output Capacitance	MODE=L		0	10	$\mu F$
		MODE=H		0	4.7	$\mu F$
$C_{OUT}$	Additional Output Capacitance	MODE=L		0	10	$\mu F$
		MODE=H		0	4.7	$\mu F$
$C_{FF}$	Feedback Capacitance (Optional)		22		pF	
$R_2$	The external resistor to GND	100		300	k $\Omega$	
$T_A$	Ambient Temperature	-40		+85	$^{\circ}C$	
$T_J$	Operating Junction Temperature	-40		+125	$^{\circ}C$	

## Electrical Characteristics (Note 2)

( $V_{IN}=V_{EN}=3.6V$ ,  $V_{OUT}=1.8V$ ,  $T_A=+25^{\circ}C$ , no external input/output capacitance,  $C_{FF}=22pF$ , unless otherwise noted)

Symbol	Parameter	Test Conditions	Min	Typ	Max	Unit
<b>Supply Power</b>						
UVLO	Under Voltage Lockout Threshold		1.8		2.3	V
UVLO_HYS	Under Voltage Lockout Hysteresis			0.2		V
$I_Q$ (Active)	Input DC Supply Current (MODE=L)	$I_{LOAD}=0mA$		56		$\mu A$
	Input DC Supply Current (MODE=H)	$I_{LOAD}=0mA$		5.6		mA
$I_Q$ (Shutdown)	Input DC Supply Current (Shutdown Mode)	$V_{EN}=0V$		0.1	1.0	$\mu A$
<b>Output</b>						
	Output Voltage Line Regulation	$2.5V \leq V_{IN} \leq 5.5V$ , $I_{OUT}=400mA$		0.10	0.20	%/V
	Output Voltage Load Regulation	$100mA \leq I_{OUT} \leq 1A$		0.5		%/A
$\Delta VO$	Ripple Voltage @the pulse skipping mode	$I_{OUT}=10mA$		35		mV p-p
	Ripple Voltage @the normal mode	$I_{OUT}=400mA$		4		mV p-p
$R_{DS(ON)}$	Input to Output On-Resistance	100% Duty Cycle $I_{OUT}=1A$		500		m $\Omega$
$t_{SS}$	Soft Start Time			400		$\mu s$
$\eta_{(max)}$	Efficiency @the pulse skipping mode	$I_{OUT}=1mA$		78		%
	Efficiency @the pulse skipping mode	$I_{OUT}=10mA$		83		
	Efficiency @ Light Load	$I_{OUT}=100mA$		86		
	Efficiency @ middle Load	$I_{OUT}=400mA$		85		
<b>FB</b>						
$V_{FB}$	Feedback Voltage	$T_A=25^{\circ}C$	0.588	0.6000	0.612	V
		$T_A=-40 \sim 85^{\circ}C$	0.5830	0.6000	0.6150	
$I_{FB}$	FB Input Bias Current	$V_{FB}=0.65V$			30	nA
<b>MODE,EN</b>						
$V_H$	MODE EN High-Level Threshold		1.2			V
$V_L$	MODE EN Low-Level Threshold				0.4	V
$I_L$	MODE Leakage Current			$\pm 0.1$	$\pm 1$	$\mu A$
<b>Oscillator</b>						
f	PFM Oscillator Frequency	$V_{FB}=0.6V$ or $V_{OUT}=100\%$	1.95	2.25	2.55	MHz

Protection						
$I_{LIM}$	Peak Input Current Limit			1.5		A
	Thermal Shutdown Temperature			160		°C
	Thermal Shutdown Trip Point Hysteresis			25		°C

Note 2: 100% production test at +25°C. Specifications over the temperature range are guaranteed by design and characterization.

## Typical Operating Characteristics

( $V_{IN}=3.6V$ ,  $V_{OUT}=1.8V$ , no external input/output capacitance,  $C_{FF}=22pF$ ,  $T_A=+25^{\circ}C$ , unless otherwise noted.)

**Efficiency vs. Load Current**  
 **$V_{OUT}=1.8V$ , Power Save Mode**

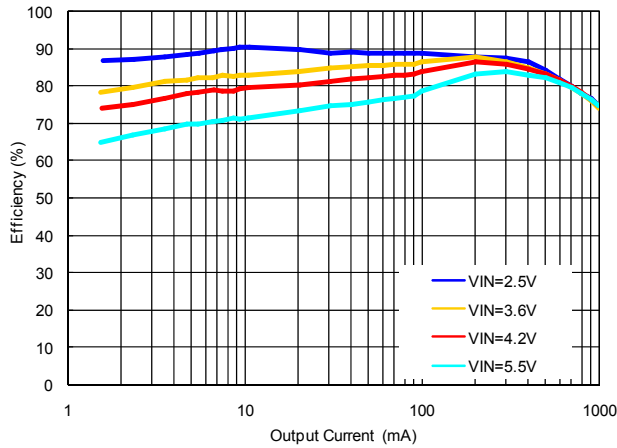

**Efficiency vs. Load Current**  
 **$V_{OUT}=1.8V$ , Forced PWM Mode**

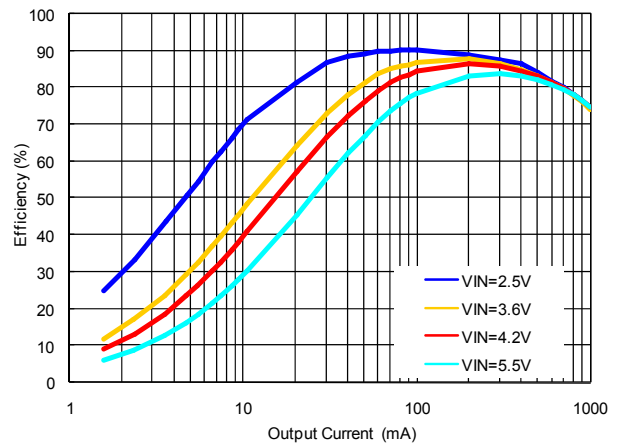

**Efficiency vs. Load Current**  
 **$V_{OUT}=3.3V$ , Power Save Mode**

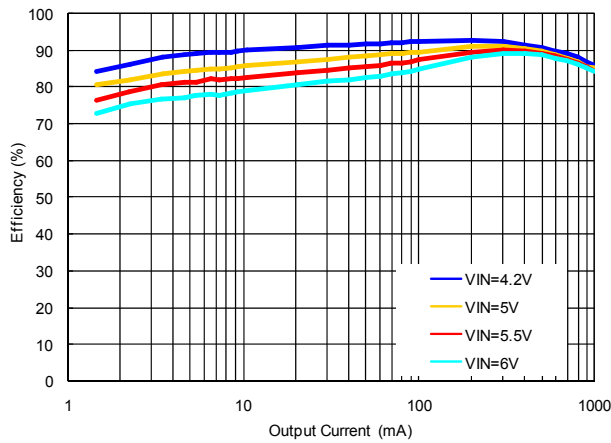

**Efficiency vs. Load Current**  
 **$V_{OUT}=3.3V$ , Forced PWM Mode**

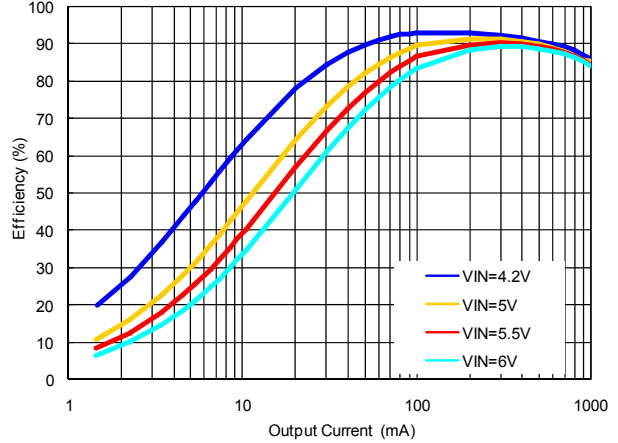

## Typical Operating Characteristics (Continued)

( $V_{IN}=3.6V$ ,  $V_{OUT}=1.8V$ , no external input/output capacitance,  $C_{FF}=22pF$ ,  $T_A=+25^{\circ}C$ , unless otherwise noted.)

**Output Voltage vs. Load Current**  
 $V_{OUT}=1.8V$ , MODE=L

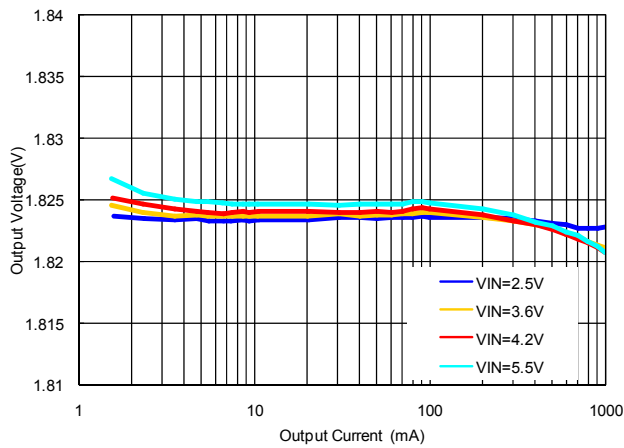

**Output Voltage vs. Load Current**  
 $V_{OUT}=1.8V$ , MODE=H

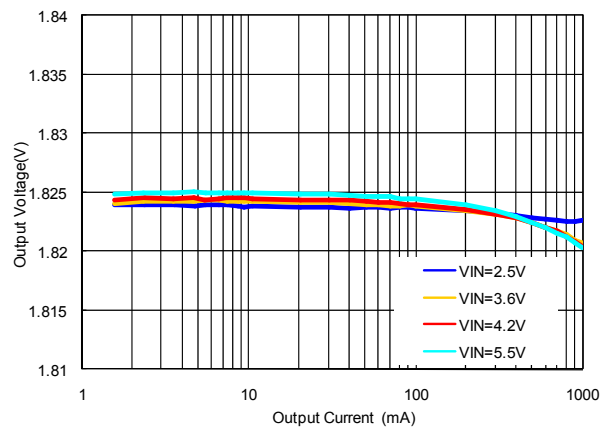

**Output Voltage vs. Load Current**  
 $V_{OUT}=3.3V$ , MODE=L

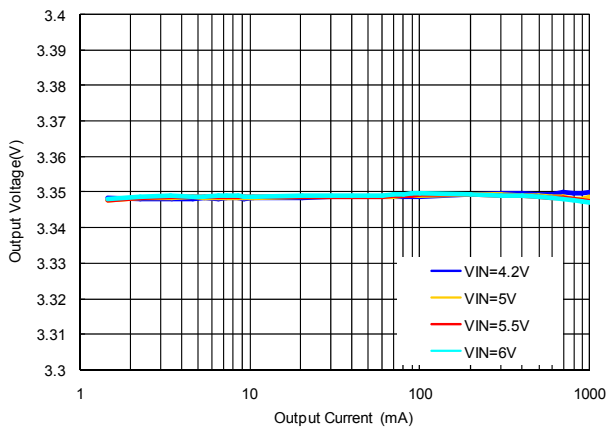

**Output Voltage vs. Load Current**  
 $V_{OUT}=3.3V$ , MODE=H

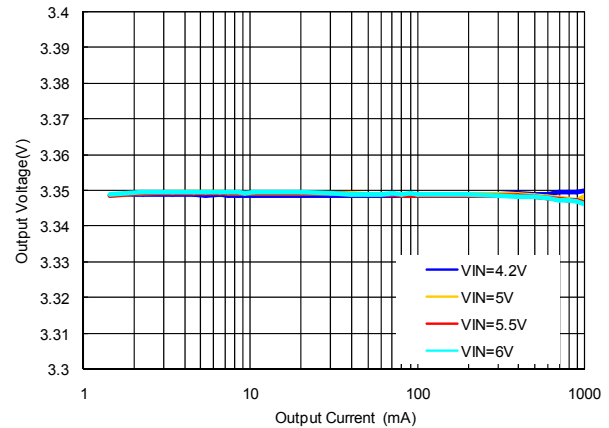

## Typical Operating Characteristics (Continued)

( $V_{IN}=3.6V$ ,  $V_{OUT}=1.8V$ , no external input/output capacitance,  $C_{FF}=22pF$ ,  $T_A=+25^{\circ}C$ , unless otherwise noted.)

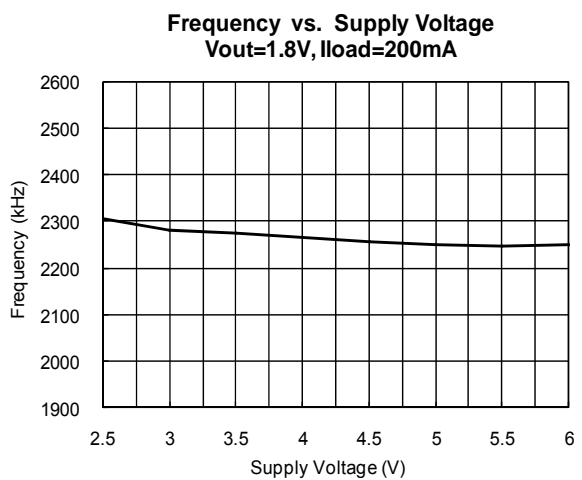
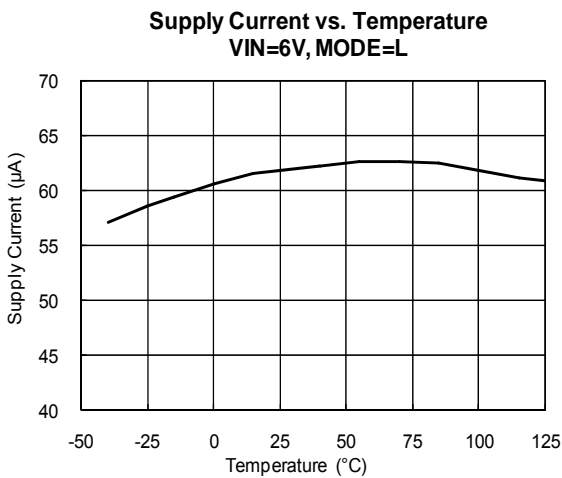
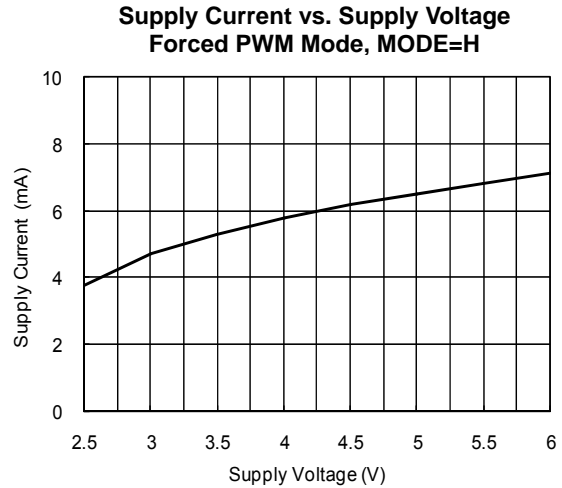
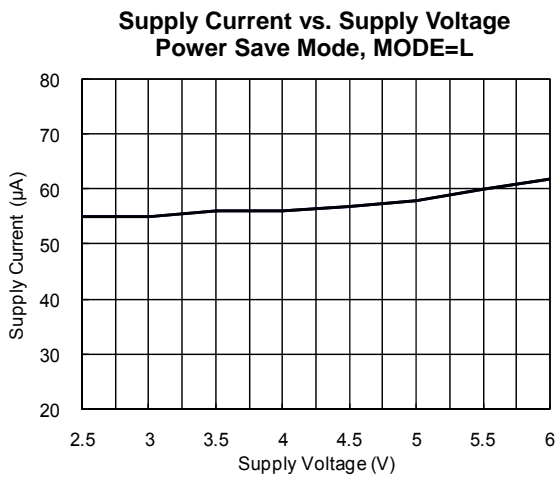
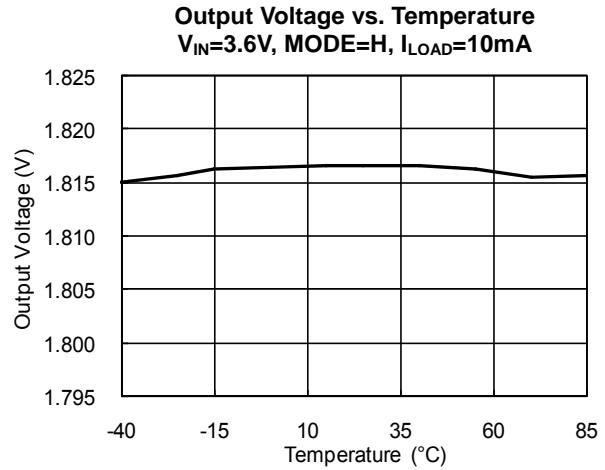
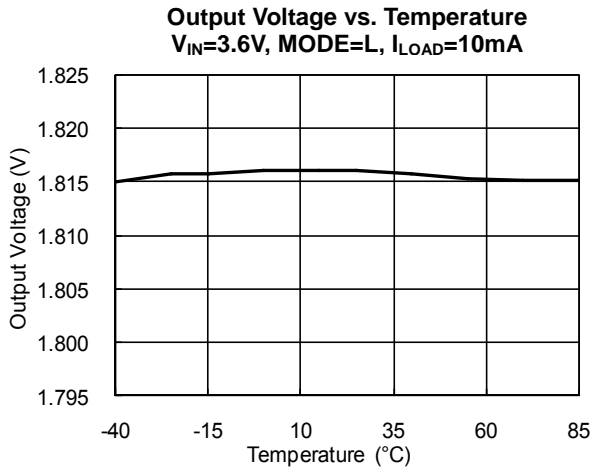



## Typical Operating Characteristics (Continued)

( $V_{IN}=3.6V$ ,  $V_{OUT}=1.8V$ , no external input/output capacitance,  $C_{FF}=22pF$ ,  $T_A=+25^{\circ}C$ , unless otherwise noted.)

### Load Transient Response

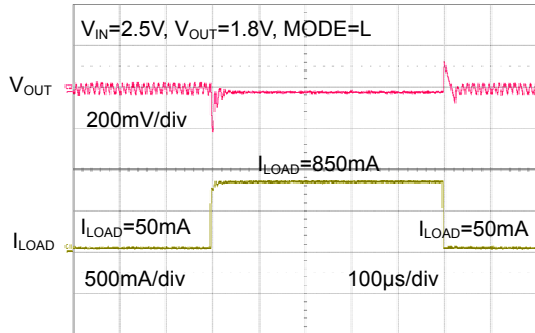

### Load Transient Response

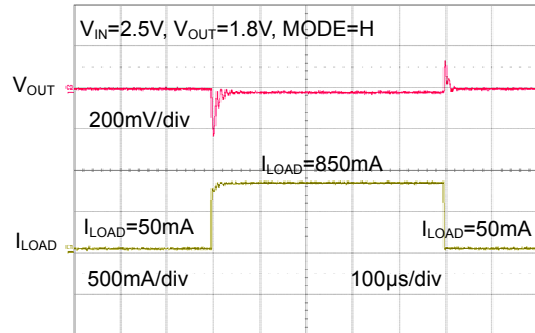

### Line Transient Response

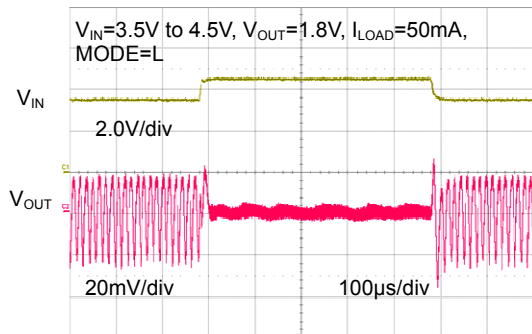

### Line Transient Response

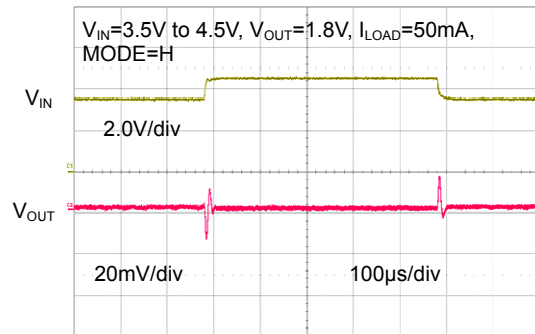

### PFM Mode Operation

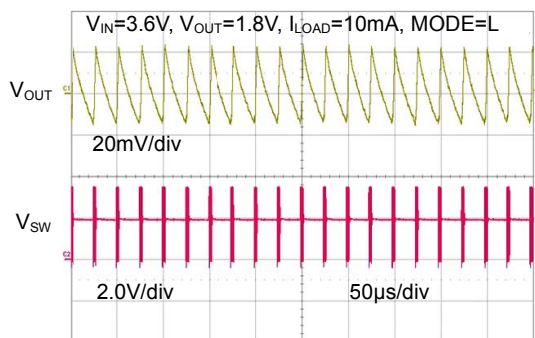

### PWM Mode Operation

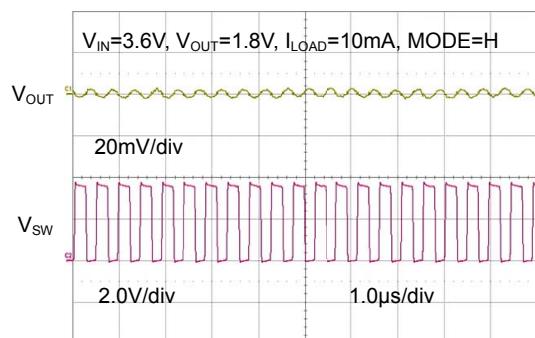

### Ripple and HF Noise ( $I_{OUT}=300mA$ )

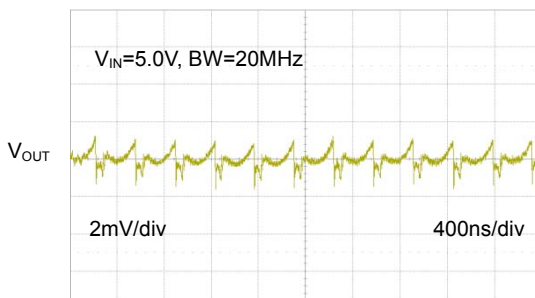

### Ripple and HF Noise ( $I_{OUT}=300mA$ )

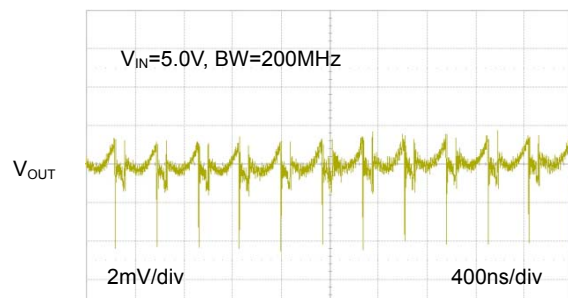

## Block Diagram

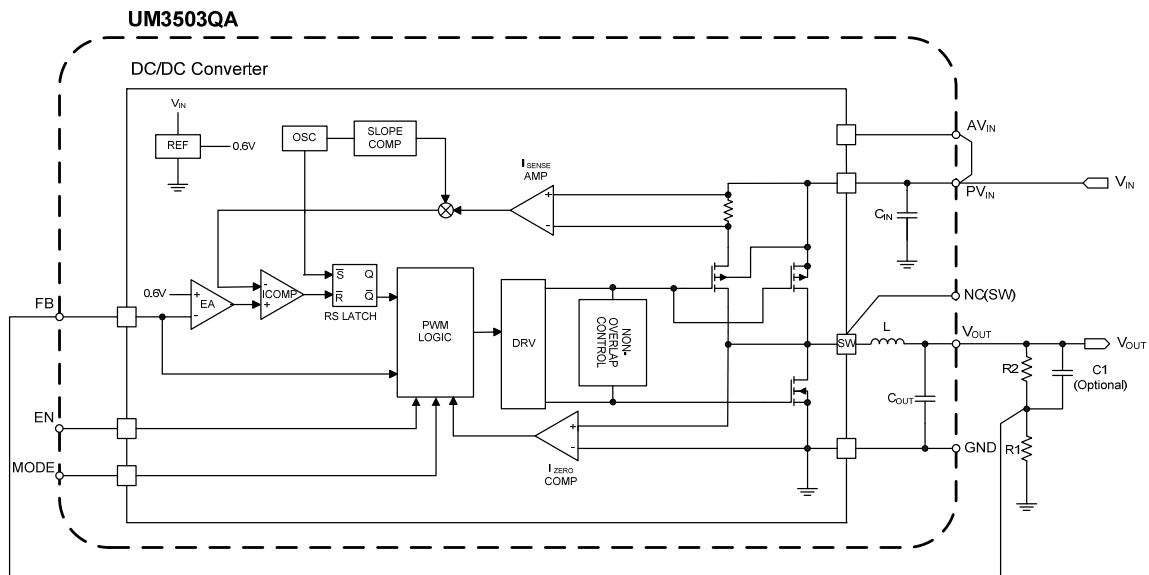

## Function Description

### Operation

The UM3503QA is a complete 1A, DC/DC step-down power supply converter. Switching regulator, inductor and input/output capacitors are integrated into a tiny QFN package. No additional components are required to finish the design.

At light load currents, the UM3503QA operates in a pulse skipping mode. At normal load, it operates in a fixed frequency mode. Combined with good load and line transient response characteristics, the low quiescent current (typical 56 $\mu$ A) allows the device to maintain high efficiency at light load, while preserving fast transient response for applications.

The UM3503QA integrates an input current limit to protect the device against heavy load or short circuits and features an undervoltage lockout circuit to prevent the device from misoperation at low input voltages.

### Pulse Skipping Mode Operation

At very light loads, the UM3503QA automatically enters Pulse Skipping Mode. In the Pulse Skipping Mode, the inductor current may reach zero or reverse on each pulse. The PWM control loop will automatically skip pulses to maintain output regulation. The bottom MOSFET is turned off by the current reversal comparator,  $I_{ZERO}$ , and the switch voltage will ring. This is discontinuous mode operation and is normal behavior for the switching regulator.

### Mode Selection

The MODE pin allows selection of the operating mode of the device. Connecting this pin to GND enables the automatic PWM and pulse skipping mode operation. The converter operates in regulated frequency PWM mode at moderate to heavy loads and in the pulse skipping mode during light loads, which maintains high efficiency over a wide load current range.

Pulling the MODE pin high forces the converter to operate in the PWM mode even at light load currents. The advantage is that the converter operates with a fixed frequency that allows simple filtering of the switching frequency for noise-sensitive applications. In this mode, the efficiency is

lower compared to the power save mode during light loads.

### Low Dropout, 100% Duty Cycle Operation

The device starts to enter 100% duty cycle mode once the input and output voltage come close together. In order to maintain the output voltage, the DC/DC converter's high-side MOSFET is turned on 100% for one or more cycles.

With further decreasing  $V_{IN}$ , the high-side switch is constantly turned on, thereby providing a low input-to-output voltage difference. This is particularly useful in battery-powered applications to achieve longest operation time by taking full advantages of the whole battery voltage range.

### Soft Start

The UM3503QA has an internal soft-start circuit that limits the inrush current during start-up. This limits input voltage drops when a battery or a high-impedance power source is connected to the input. This mode of operation continues for typical 400 $\mu$ s after enable.

### Enable

The EN pin provides a means to shut down the converter or enable normal operation. A logic low will disable the converter and cause it into shut down. A logic high will enable the converter into normal operation. In shutdown mode, the quiescent current of the device will be less than 1 $\mu$ A. The EN pin must not be left floating.

### Input Capacitor Selection

Because of the pulsating input current nature of the buck converter, a low ESR input capacitor is required to prevent large voltage transients that can cause misbehavior of the device or interference in other circuits in the system.

For most applications, the input capacitor that is integrated into the UM3503QA should be sufficient. If the application exhibit a noisy or erratic switching frequency, experiment with additional input ceramic capacitor to find a remedy.

The UM3503QA uses a tiny ceramic input capacitor. When a ceramic capacitor is combined with trace or cable inductance, such as from a wall adapter, a load step at the output can induce ringing at the  $V_{IN}$  pin. This ringing can couple to the output and be mis-treated as loop instability or can even damage the part. In this circumstance, an additional "bulk" capacitor, such as electrolytic or tantalum, should be placed between the input of the converter and the power source. This will lead to reducing ringing that may occur between the inductance of the power source leads and  $C_{IN}$ .

### Output Capacitor Selection

The advanced, fast-response, current mode control scheme of the UM3503QA allows the use of a tiny ceramic output capacitor ( $C_{OUT}$ ). For most applications, the output capacitor integrated in the UM3503QA is sufficient.

At normal load current, the device operates in PWM mode; the overall output voltage ripple is the sum of the voltage step that is caused by the output capacitor ESL and the ripple current that flows through the output capacitor impedance. At light loads, the output capacitor limits the output ripple voltage and provides holdup during large load transitions.

The UM3503QA is designed as a Point-Of-Load (POL) regulator, to operate stand-alone without requiring any additional capacitance. Adding a 10 $\mu$ F ceramic output capacitor (X7R or X5R dielectric) generally works from a converter stability point of view, helps to minimize the output ripple voltage in pulse skipping mode and improves the converter's transient response when input and output voltage are close together.

## **Thermal Shutdown**

When excessive power is dissipated in the chip, the junction temperature rises. Once the junction temperature exceeds the thermal shutdown temperature, the thermal shutdown circuit turns off the converter output voltage thus allowing the device to cool. When the junction temperature decreases by 25°C, the device will go through the normal startup process.

## Applications Information

### Output Voltage Setting

The output voltage can be calculated according to the formula below with an internal reference voltage  $V_{REF}$  typical 0.6V:

$$V_{OUT} = V_{REF} \times \left( 1 + \frac{R1}{R2} \right)$$

To minimize the current through the feedback divider network, the recommended value of R2 is about 180k $\Omega$ . The sum of R1 and R2 should not exceed about 1M $\Omega$  to keep the network robust against noise. An external feed forward capacitor C1 is required for optimum load transient response. The value of C1 should be in the range between 10pF and 33pF.

Route the FB line away from noise sources, such as the inductor or the SW line.

### Exposed Metal on the Bottom of the Package

The UM3503QA utilizes the lead frame as part of the electrical circuit. The lead frame offers many advantages in thermal performance, in reduced electrical lead resistance and in overall foot print. However, it does require some special considerations.

As part of the package assembly process, lead frame construction requires for mechanical support, some of the lead-frame metal is exposed at the point where wire-bond or internal passives are attached. This results in several small pads being exposed on the bottom of the package.

The “grayed-out” area in Figure 1 represents the area that should be clear of any metal (traces, vias, or planes) on the top layer of the PCB. The exposed thermal pad should be connected to the ground plane by vias for better thermal performance.

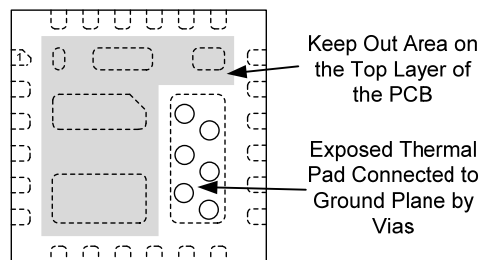

Figure 1. Exposed Metal of the Package

### Layout Guidance

The package of the UM3503QA has been optimized that makes it easy for layout. It is an ideal choice to be used to replace less efficient LDO to achieve improved efficiency in space restricted applications.

When laying out the PC board, the following suggestions should be taken to ensure higher performance of the UM3503QA.

1. PCB with at least two planes is recommended. Keep the GND plane under the converter as complete as possible.
2. Although  $C_{IN}$  and  $C_{OUT}$  have been integrated inside the chip, additional input and output capacitors can also be added to achieve better performance. Please connect the additional input capacitor to the  $PV_{IN}$  and GND pins, the additional output capacitor to the  $V_{OUT}$  and GND pins as closely as possible to get good power filter effect.
3. The power traces, including the GND trace, the  $PV_{IN}$  trace and  $V_{OUT}$  trace should be kept short, direct and wide to allow large current flow.
4. The  $AV_{IN}$  pin is usually connected to  $PV_{IN}$  in the PCB or externally connected to  $V_{IN}$  with

a decouple capacitor alone. A  $0.1\mu\text{F}$  capacitor can be used to decouple for better performance.

5. Keep the SW pin away from the sensitive FB node. This pin should also not be electrically connected to any external signal, ground, or voltage.
6. Do not trace signal line under the chip.
7. For better thermal performance, the exposed thermal pad should be connected to the ground plane by vias.

The recommended layout is shown below in Figure 2.

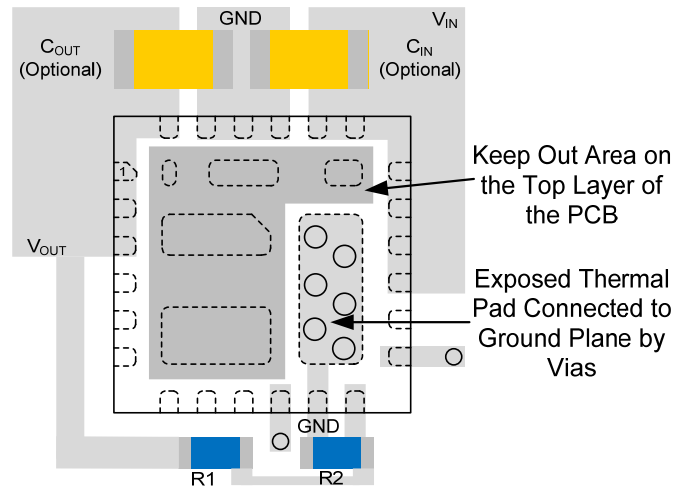

Figure 2. Layout Recommendation

## Package Information

### UM3503QA: QFN24 4.0×4.0

#### Outline Drawing

Symbol	DIMENSIONS					
	MILLIMETERS			INCHES		
	Min	Typ	Max	Min	Typ	Max
A	1.00	1.05	1.10	0.039	0.041	0.043
A1	0.00	0.02	0.05	0.000	0.001	0.002
A3	0.152REF			0.006REF		
b	0.20	0.25	0.30	0.008	0.010	0.012
D	3.90	4.00	4.10	0.154	0.157	0.161
E	3.90	4.00	4.10	0.154	0.157	0.161
D1	0.40	0.50	0.60	0.016	0.020	0.024
E1	0.25	0.35	0.45	0.010	0.014	0.018
D2	0.75	0.85	0.95	0.030	0.033	0.037
E2	1.92	2.02	2.12	0.076	0.080	0.083
D3	1.37	1.47	1.57	0.054	0.058	0.062
E3	0.45	0.55	0.65	0.018	0.022	0.026
D4	1.37	1.47	1.57	0.054	0.058	0.062
E4	0.67	0.77	0.87	0.026	0.030	0.034
D5	0.84	0.94	1.04	0.033	0.037	0.041
E5	0.25	0.35	0.45	0.010	0.014	0.018
D6	0.10	0.20	0.30	0.004	0.008	0.012
E6	0.25	0.35	0.45	0.010	0.014	0.018
e	0.40	0.50	0.60	0.016	0.020	0.024
H	0.125REF			0.005REF		
H1	0.25REF			0.010REF		
K	0.20	0.30	0.40	0.008	0.012	0.016
K1	0.25	0.35	0.45	0.010	0.014	0.018
K2	0.25	0.35	0.45	0.010	0.014	0.018
K3	0.25	0.35	0.45	0.010	0.014	0.018
L	0.25	0.30	0.35	0.010	0.012	0.014
M	0.28	0.38	0.48	0.011	0.015	0.019
M1	0.60	0.70	0.80	0.024	0.028	0.031
M2	0.28	0.38	0.48	0.011	0.015	0.019
M3	0.53	0.63	0.73	0.021	0.025	0.029
M4	0.33	0.43	0.53	0.013	0.017	0.021

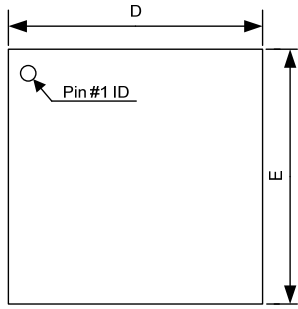

Top View

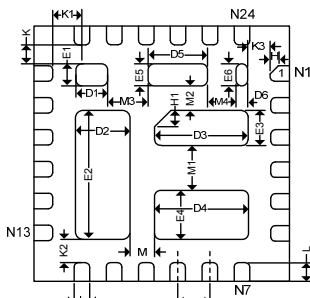

Bottom View



Side View

## Land Pattern

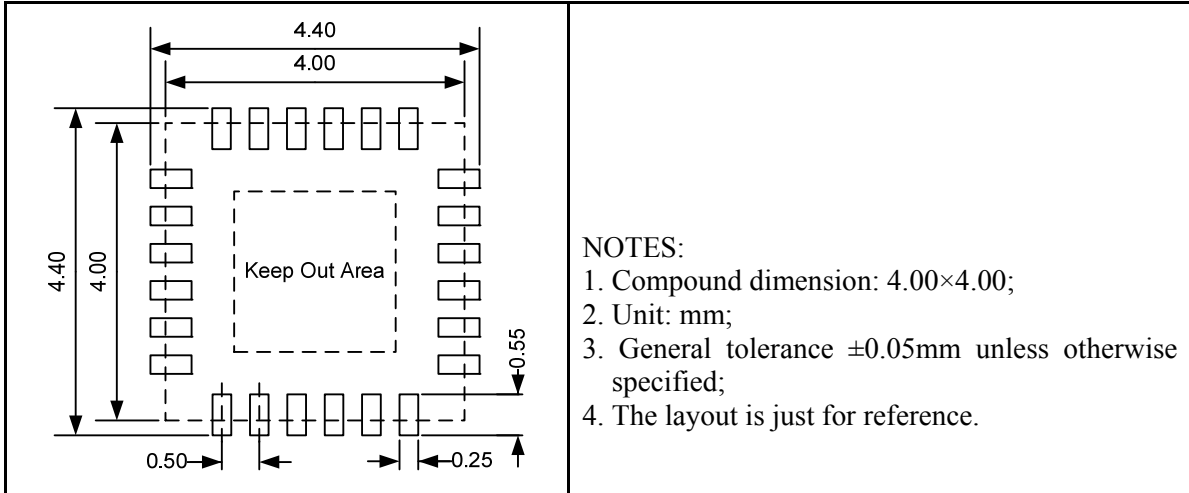

## Tape and Reel Orientation





---

## GREEN COMPLIANCE

Union Semiconductor is committed to environmental excellence in all aspects of its operations including meeting or exceeding regulatory requirements with respect to the use of hazardous substances. Numerous successful programs have been implemented to reduce the use of hazardous substances and/or emissions.

All Union components are compliant with the RoHS directive, which helps to support customers in their compliance with environmental directives. For more green compliance information, please visit:

[http://www.union-ic.com/index.aspx?cat\\_code=RoHSDeclaration](http://www.union-ic.com/index.aspx?cat_code=RoHSDeclaration)

## IMPORTANT NOTICE

The information in this document has been carefully reviewed and is believed to be accurate. Nonetheless, this document is subject to change without notice. Union assumes no responsibility for any inaccuracies that may be contained in this document, and makes no commitment to update or to keep current the contained information, or to notify a person or organization of any update. Union reserves the right to make changes, at any time, in order to improve reliability, function or design and to attempt to supply the best product possible.



Union Semiconductor, Inc

Add: Unit 606, No.570 Shengxia Road, Shanghai 201210

Tel: 021-51093966

Fax: 021-51026018

Website: [www.union-ic.com](http://www.union-ic.com)