

-30V P-Channel Enhancement Mode MOSFET

■ DESCRIPTION

The UM4409 is the P-Channel logic enhancement mode power field effect transistor is produced using high cell density advanced trench technology..

This high density process is especially tailored to minimize on-state resistance. These devices are particularly suited for low voltage application, notebook computer power management and other battery powered circuits where high-side switching

■ FEATURE

- ◆ -30V/-15A, $R_{DS(ON)}=8m\Omega$ (typ.)@ $V_{GS}=-10V$
- ◆ -30V/-10A, $R_{DS(ON)}=10m\Omega$ (typ.)@ $V_{GS}=-4.5V$
- ◆ Super high design for extremely low $R_{DS(ON)}$
- ◆ Exceptional on-resistance and Maximum DC current capability
- ◆ Full RoHS compliance
- ◆ SOP8 package design

■ APPLICATIONS

- ◆ High Frequency Point-of-Load Synchronous
- ◆ Networking DC-DC Power System
- ◆ Load Switch

■ PIN CONFIGURATION

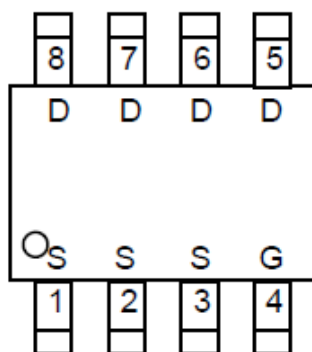

TOP VIEW
SOP-8

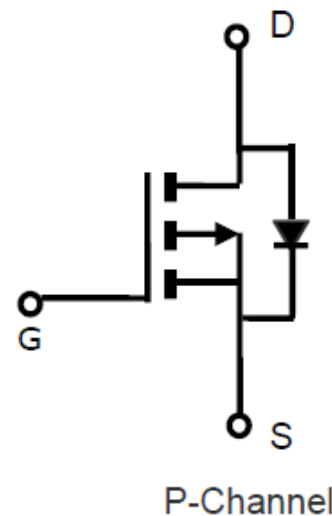

P-Channel

■ PART NUMBER INFORMATION

UM4409A-BB C	A= Package Code S: SOP BB=Handing Code TR: Tape&Reel C=Lead Plating Code G: Green Product
--------------	--

■ ORDERING INFORMATION

Part Number	Package Code	Package	Shipping
UM4409S-TRG	S	SOP8	3000EA / T&R

- ※ Year Code : 0~9
- ※ Week Code : A~Z(1-26); a~z(27~52)
- ※ G : Green Product. This product is RoHS compliant.

■ ABSOLUTE MAXIMUM RATINGS ($T_A = 25^\circ\text{C}$ Unless otherwise noted)

Symbol	Parameter	Typical	Unit
V_{DSS}	Drain-Source Voltage	-30	V
V_{GSS}	Gate-Source Voltage	± 20	V
I_D	Continuous Drain Current ($T_A=25^\circ\text{C}$)	$V_{GS}=10\text{V}$ -14	A
I_{DM}	Pulsed Drain Current	-70	A
I_S	Continuous Source Current (Diode Conduction)	-2.7	A
P_D	Power Dissipation	$T_A=25^\circ\text{C}$	W
		$T_A=70^\circ\text{C}$	
T_J	Operation Junction Temperature	150	$^\circ\text{C}$
T_{STG}	Storage Temperature Range	-55~+150	$^\circ\text{C}$
$R_{\theta JA}$	Thermal Resistance Junction to Ambient	85	$^\circ\text{C/W}$

Note: Absolute maximum ratings are those values beyond which the device could be permanently damaged. Absolute maximum ratings are stress rating only and functional device operation is not implied

■ **ELECTRICAL CHARACTERISTICS** ($T_A=25^\circ\text{C}$ Unless otherwise noted)

Symbol	Parameter	Condition	Min	Typ	Max	Unit
Static Parameters						
$V_{(BR)DSS}$	Drain-Source Breakdown Voltage	$V_{GS}=0V, I_D=-250\mu A$	-30			V
$V_{GS(th)}$	Gate Threshold Voltage	$V_{DS}=V_{GS}, I_D=-250\mu A$	-1.0	-1.3	-2.0	V
I_{GSS}	Gate Leakage Current	$V_{DS}=0V, V_{GS}=\pm 20V$			± 100	nA
I_{DSS}	Zero Gate Voltage Drain Current	$V_{DS}=-24V, V_{GS}=0$			-1	uA
		$V_{DS}=-24V, V_{GS}=0$ $T_J=55^\circ\text{C}$			-5	
$R_{DS(ON)}$	Drain-Source On-Resistance	$V_{GS}=-10V, I_D=-15A$		8	11	m Ω
		$V_{GS}=-4.5V, I_D=-10A$		10	13	
Source-Drain Diode						
V_{SD}	Diode Forward Voltage	$I_S=-1.0A, V_{GS}=0V$		-0.71	-1.0	V
Dynamic Parameters						
Q_g	Total Gate Charge	$V_{DS}=-15V$ $V_{GS}=-4.5V$ $I_D=-15A$		37.08	48.2	nC
Q_{gs}	Gate-Source Charge			10.12	13.16	
Q_{gd}	Gate-Drain Charge			11.24	14.61	
C_{iss}	Input Capacitance	$V_{DS}=-15V$ $V_{GS}=0V$ $f=1\text{MHz}$		3887		pF
C_{oss}	Output Capacitance			577		
C_{rss}	Reverse Transfer Capacitance			425		
$T_{d(on)}$	Turn-On Time	$V_{DS}=-15V$ $I_D=-10A$		19.52	39.04	nS
T_r				10.12	20.34	
$T_{d(off)}$	Turn-Off Time	$V_{GEN}=-10V$ $R_G=6\Omega$		137.6	275.2	
T_f				55.32	110.64	

Note: 1. Pulse test: pulse width \leq 300uS, duty cycle \leq 2%

2. Static parameters are based on package level with recommended wire bonding

■ **TYPICAL CHARACTERISTICS (25 °C Unless Note)**

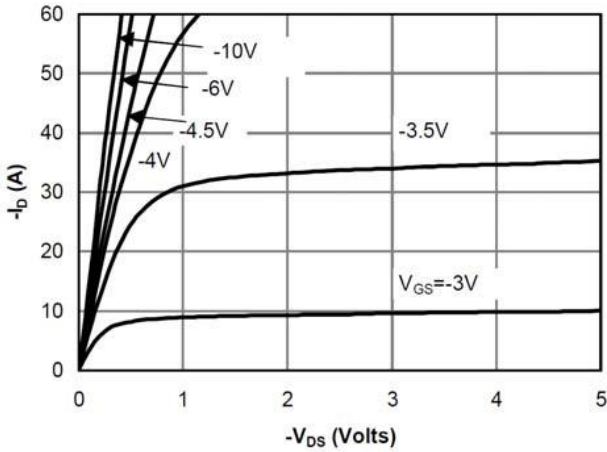

Fig 1: On-Region Characteristics

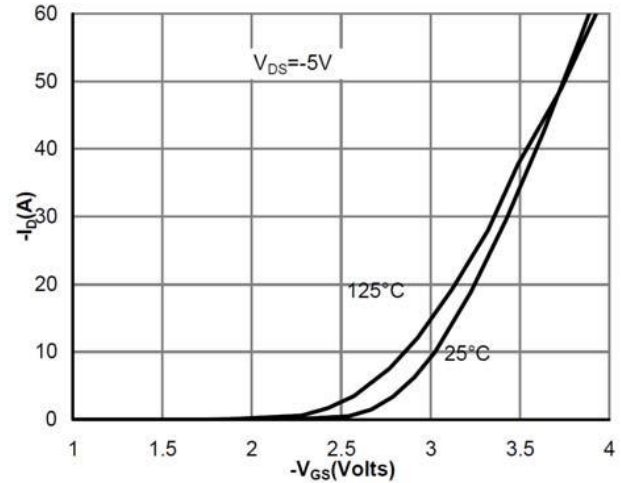

Figure 2: Transfer Characteristics

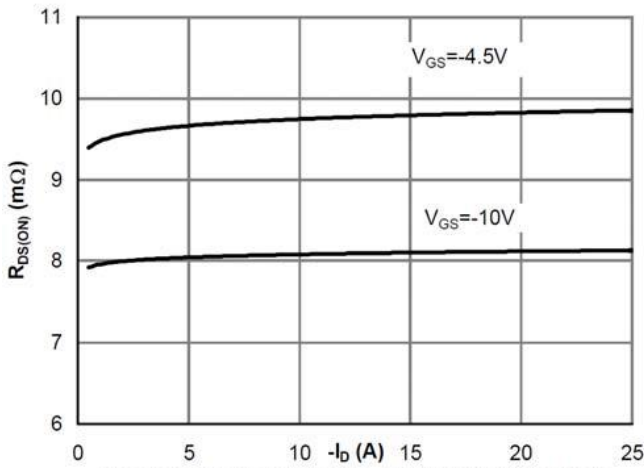

Figure 3: On-Resistance vs. Drain Current and Gate Voltage

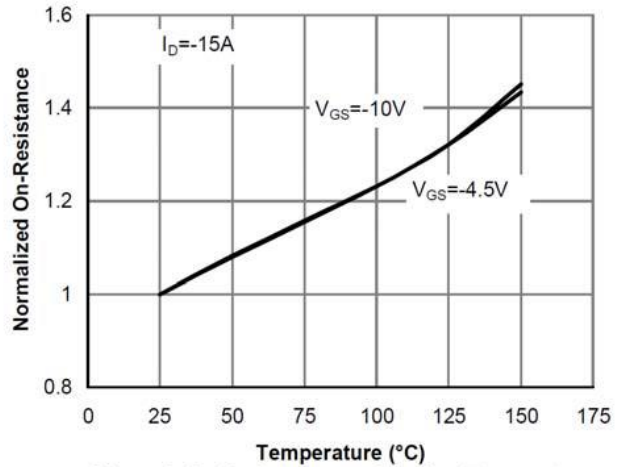

Figure 4: On-Resistance vs. Junction Temperature

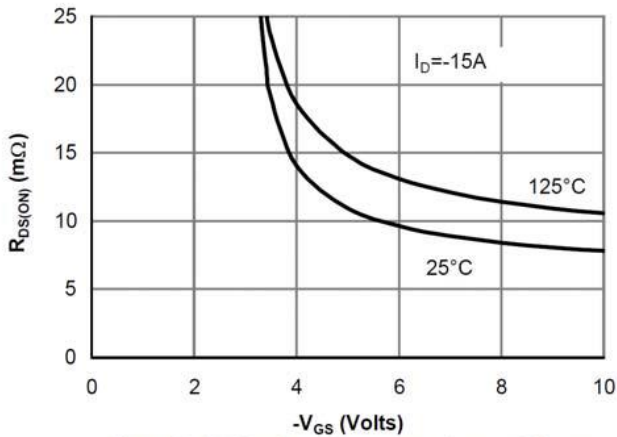

Figure 5: On-Resistance vs. Gate-Source Voltage

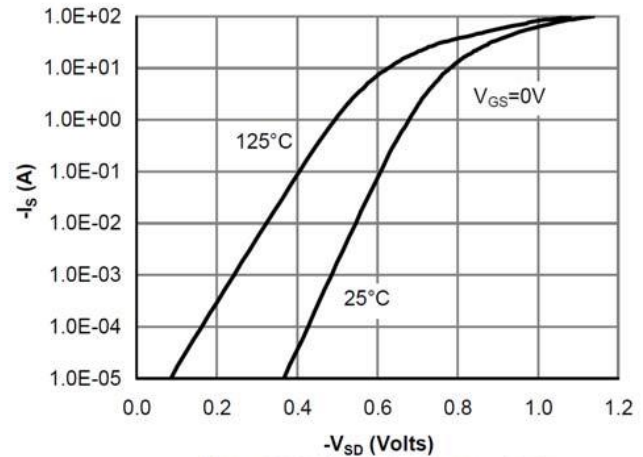

Figure 6: Body-Diode Characteristics

TYPICAL CHARACTERISTICS (continuous)

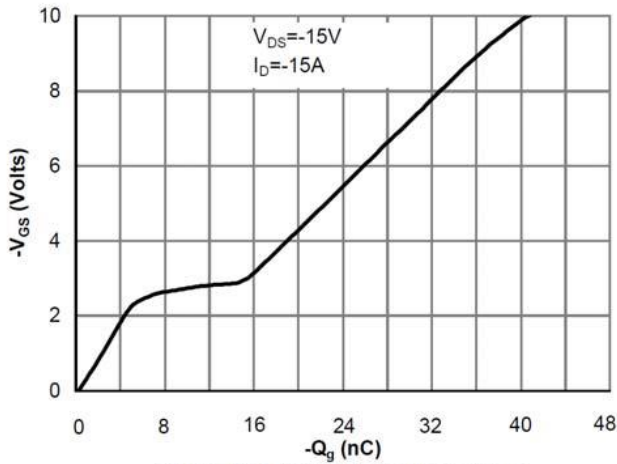

Figure 7: Gate-Charge Characteristics

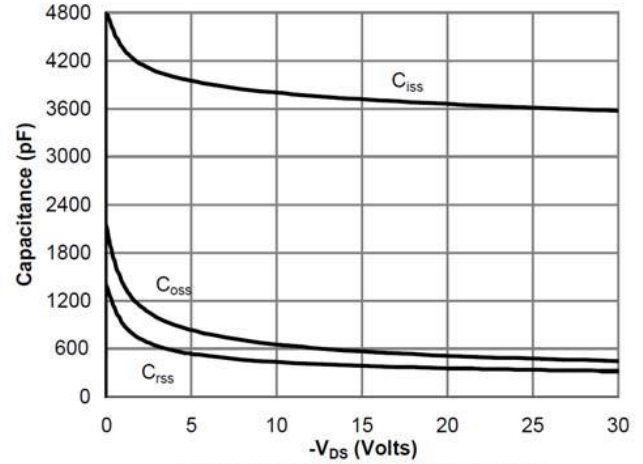

Figure 8: Capacitance Characteristics

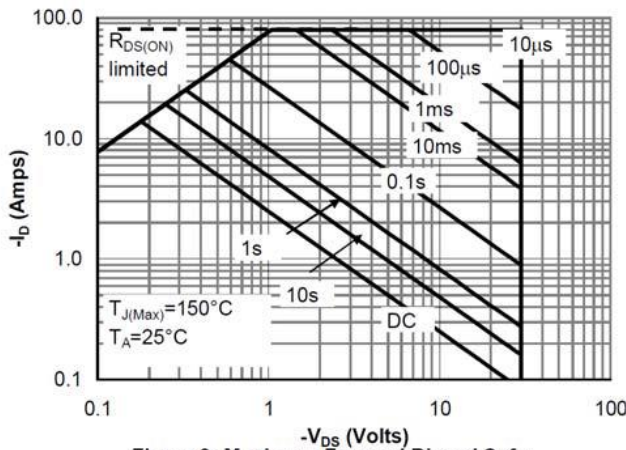

Figure 9: Maximum Forward Biased Safe Operating Area

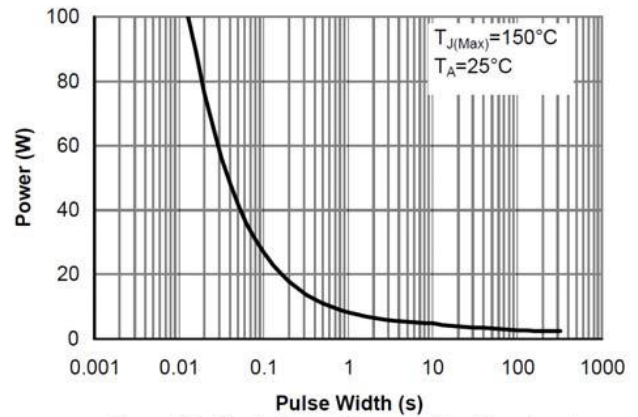

Figure 10: Single Pulse Power Rating Junction-to-Ambient

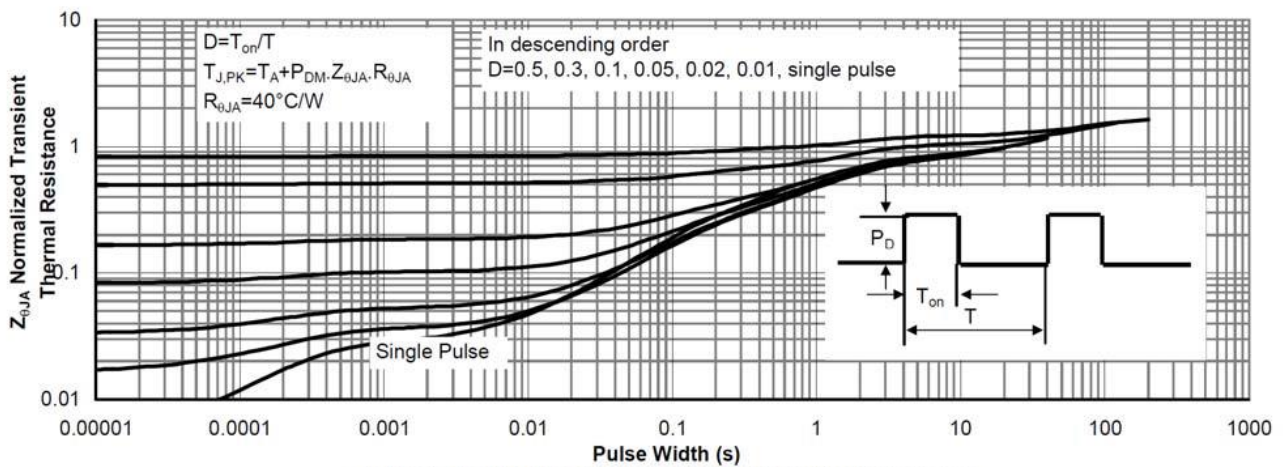
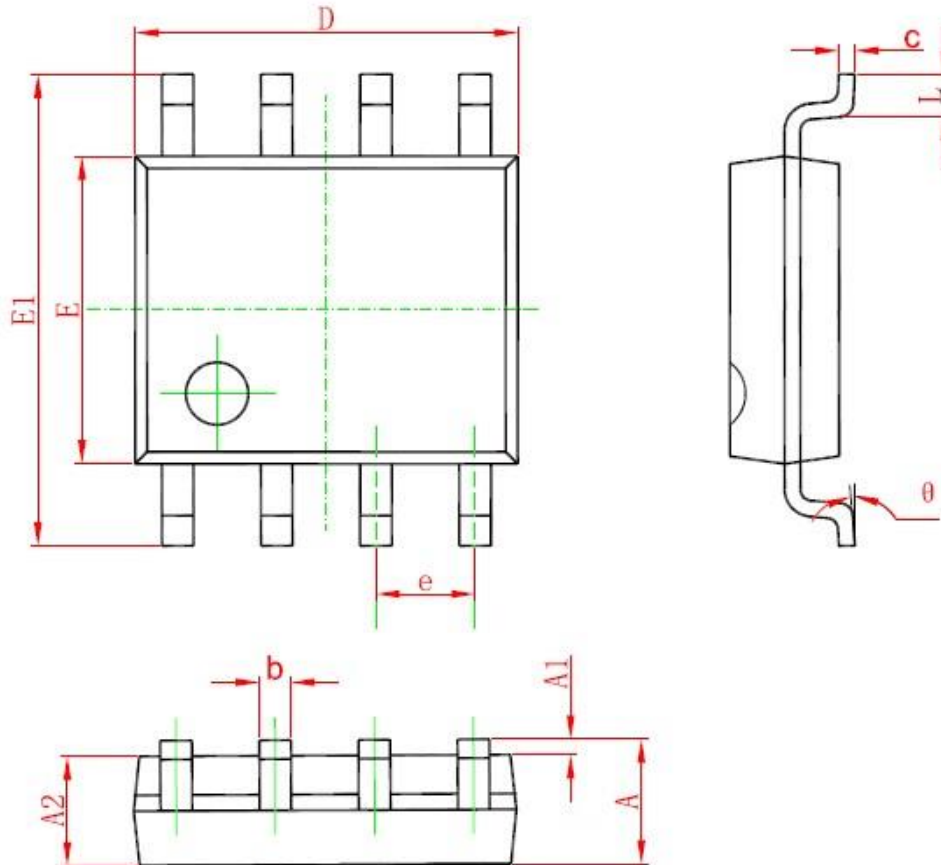

Figure 11: Normalized Maximum Transient Thermal Impedance

■ SOP8 PACKAGE OUTLINE DIMENSIONS



Symbol	Dimensions In Millimeters		Dimensions In Inches	
	Min	Max	Min	Max
A	1.350	1.750	0.053	0.069
A1	0.100	0.250	0.004	0.010
A2	1.350	1.550	0.053	0.061
b	0.330	0.510	0.013	0.020
c	0.170	0.250	0.006	0.010
D	4.700	5.100	0.185	0.200
E	3.800	4.000	0.150	0.157
E1	5.800	6.200	0.228	0.244
e	1.270 (BSC)		0.050 (BSC)	
L	0.400	1.270	0.016	0.050
θ	0°	8°	0°	8°

■ SOLDERING METHODS FOR UNIVERCHIP

Storage environment Temperature=10°C~35°C Humidity=65%±15%

Reflow soldering of surface mount device

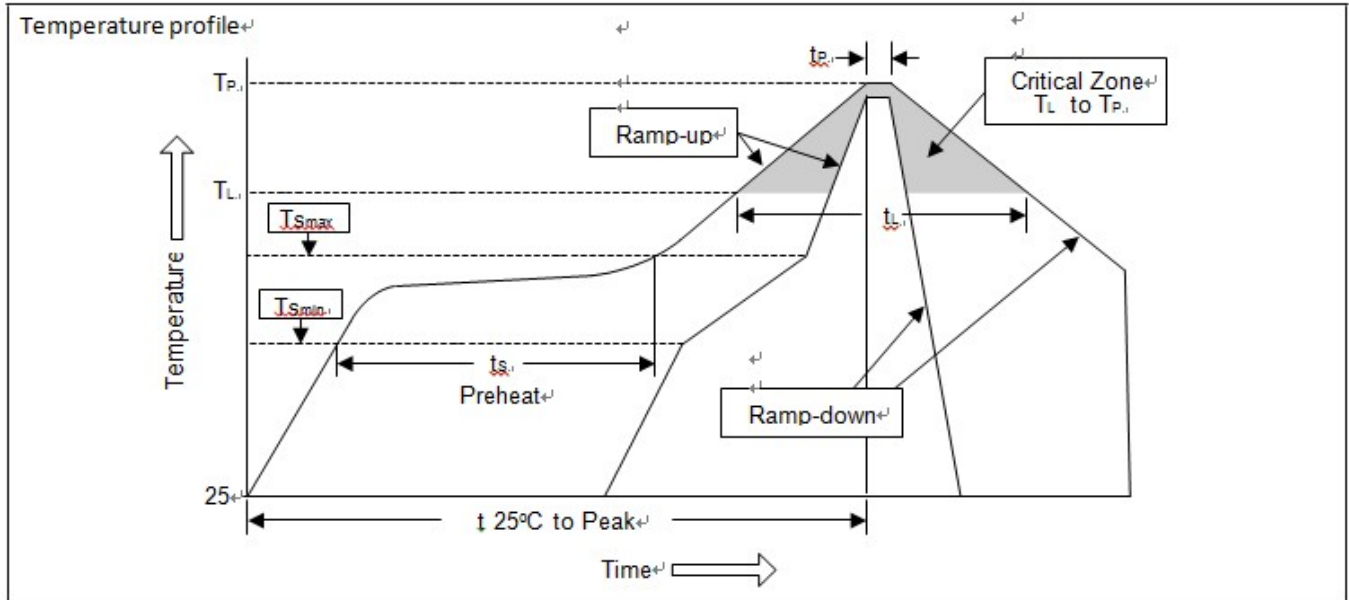

Profile Feature	Sn-Pb Eutectic Assembly	Pb free Assembly
Average ramp-up rate (T_L to T_P)	<3°C/sec	<3°C/sec
Preheat		
-Temperature Min (T_{Smin})	100°C	150°C
-Temperature Max (T_{Smax})	150°C	200°C
-Time (min to max) (t_s)	60~120 sec	60~180 sec
T_{Smax} to T_L		
-Ramp-up Rate	<3°C/sec	<3°C/sec
Time maintained above		
-Temperature (T_L)	183°C	217°C
-Time (t_L)	60~150 sec	60~150 sec
Peak Temperature (T_P)	240°C+0/-5°C	260°C+0/-5°C
Time within 5°C of actual Peak Temperature (t_P)	10~30 sec	20~40 sec
Ramp-down Rate	<6°C/sec	<6°C/sec
Time 25°C to Peak Temperature	<6 minutes	<6 minutes

Flow (wave) soldering (solder dipping)

Product	Peak Temperature	Dipping Time
Pb device	245°C±5°C	5sec±1sec
Pb-Free device	260°C+0/-5°C	5sec±1sec



This integrated circuit can be damaged by ESD UniverChip Corporation recommends that all integrated circuits be handled with appropriate precautions. Failure to observe proper handling and installation procedure can cause damage. ESD damage can range from subtle performance degradation to complete device failure. Precision integrated circuits may be more susceptible to damage because very small parametric changes could cause the device not to meet its published specifications.