

Small switching (30V, 0.1A)

UM5K1N

●Features

- 1) Two 2SK3018 transistors in a single UMT package.
- 2) Mounting cost and area can be cut in half.
- 3) Low on-resistance.
- 4) Low voltage drive (2.5V) makes this device ideal for portable equipment.
- 5) Easily designed drive circuits.

●Applications

Interfacing, switching (30V, 100mA)

●Structure

Silicon N-channel
MOSFET

●External dimensions (Units: mm)

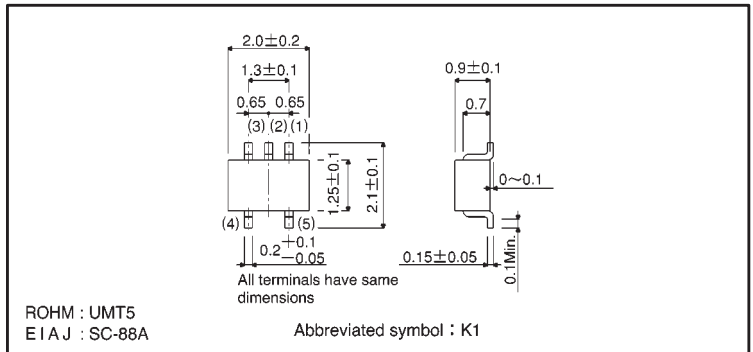

●Equivalent circuit

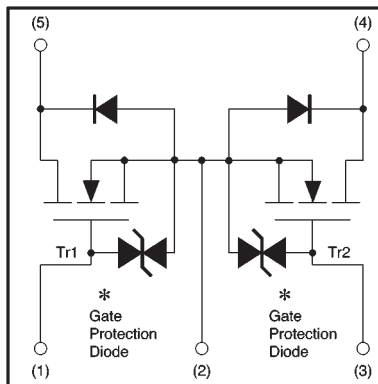

- (1) Tr1 Gate
- (2) Source
- (3) Tr2 Gate
- (4) Tr2 Drain
- (5) Tr1 Drain

* A protection diode has been built in between the gate and the source to protect against static electricity when the product is in use. Use the protection circuit when rated voltages are exceeded.

●Absolute maximum ratings (Ta = 25°C)

Parameter	Symbol	Limits	Unit
Drain-source voltage	V _{DSS}	30	V
Gate-source voltage	V _{GSS}	±20	V
Drain current	Continuous	I _D	100 mA
	Pulsed	I _{DP} *1	200 mA
Reverse drain current	Continuous	I _{DR}	100 mA
	Pulsed	I _{DRP} *1	200 mA
Total power dissipation (Tc=25°C)	P _D *2	150	mW
Channel temperature	T _{ch}	150	°C
Storage temperature	T _{stg}	-55~+150	°C

*1 P_w ≤ 10 μs, Duty cycle ≤ 50%

*2 With each pin mounted on the recommended lands.

●Packaging specifications

Type	Package	Taping
	Code	TR
	Basic ordering unit (pieces)	3000
UM5K1N		○

●Electrical characteristics (Ta = 25°C)

Parameter	Symbol	Min.	Typ.	Max.	Unit	Test Conditions
Gate-source leakage	I_{GSS}	—	—	± 1	μA	$V_{GS} = \pm 20V, V_{DS} = 0V$
Drain-source breakdown voltage	$V_{(BR)DSS}$	30	—	—	V	$I_D = 10 \mu A, V_{GS} = 0V$
Zero gate voltage drain current	I_{DSS}	—	—	1.0	μA	$V_{DS} = 30V, V_{GS} = 0V$
Gate threshold voltage	$V_{GS(th)}$	0.8	—	1.5	V	$V_{DS} = 3V, I_D = 100 \mu A$
Static drain-source on-stage resistance	$R_{DS(on)}$	—	5	8	Ω	$I_D = 10mA, V_{GS} = 4V$
	$R_{DS(on)}$	—	7	13	Ω	$I_D = 1mA, V_{GS} = 2.5V$
Forward transfer admittance	$ Y_{fs} $	20	—	—	mS	$I_D = 10mA, V_{DS} = 3V$
Input capacitance	C_{iss}	—	13	—	pF	$V_{DS} = 5V$
Output capacitance	C_{oss}	—	9	—	pF	$V_{GS} = 0V$
Reverse transfer capacitance	C_{rss}	—	4	—	pF	$f = 1MHz$
Turn-on delay time	$t_{d(on)}$	—	15	—	ns	$I_D = 10mA, V_{DD} = 5V$
Rise time	t_r	—	35	—	ns	$V_{GS} = 5V$
Turn-off delay time	$t_{d(off)}$	—	80	—	ns	$R_L = 500 \Omega$
Fall time	t_f	—	80	—	ns	$R_{GS} = 10 \Omega$

●Electrical characteristic curves

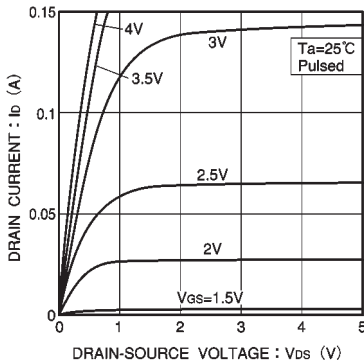

Fig.1 Typical output characteristics

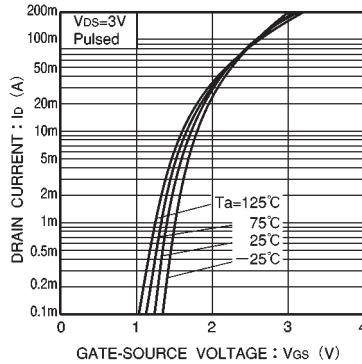

Fig.2 Typical transfer characteristics

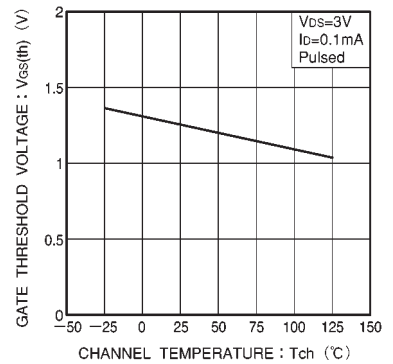

Fig.3 Gate threshold voltage vs. channel temperature

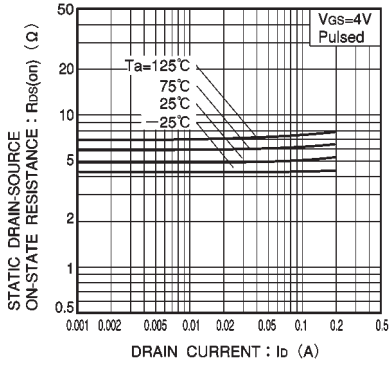

Fig.4 Static drain-source on-state resistance vs. drain current (I)

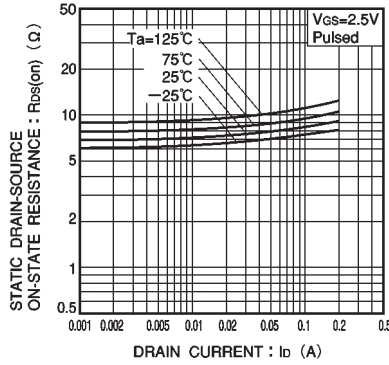

Fig.5 Static drain-source on-state resistance vs. drain current (II)

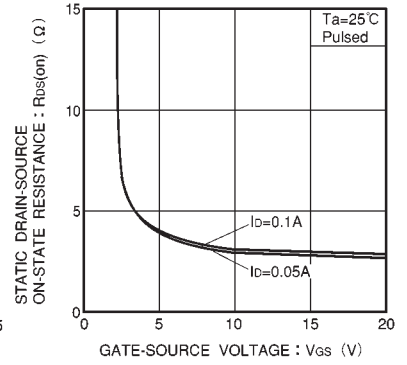

Fig.6 Static drain-source on-state resistance vs. gate-source voltage

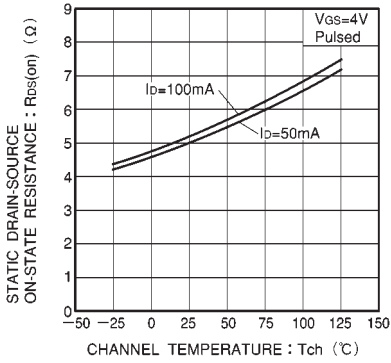

Fig.7 Static drain-source on-state resistance vs. channel temperature

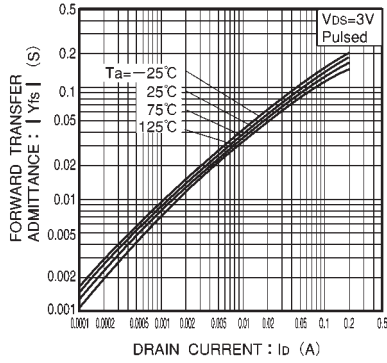

Fig.8 Forward transfer admittance vs. drain current

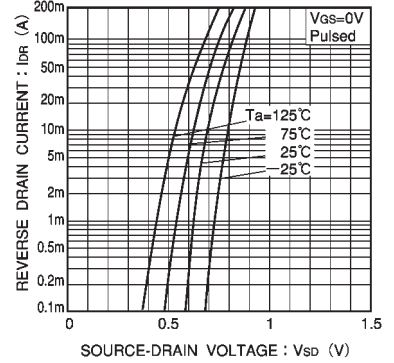

Fig.9 Reverse drain current vs. source-drain voltage (I)

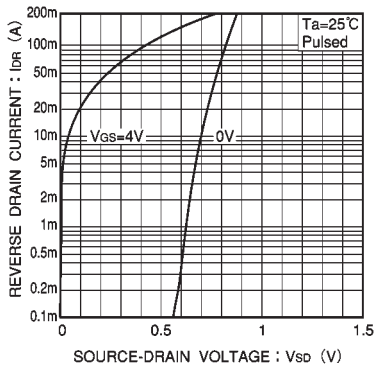

Fig.10 Reverse drain current vs. source-drain voltage (II)

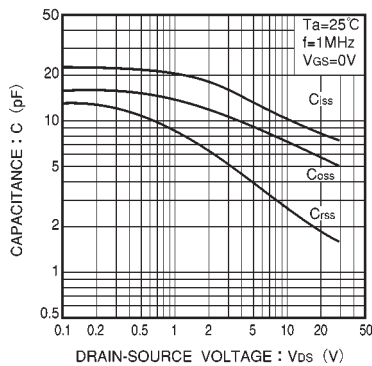

Fig.11 Typical capacitance vs. drain-source voltage

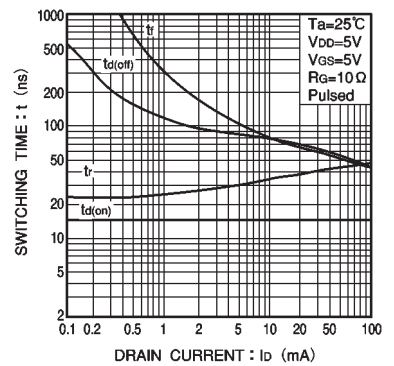

Fig.12 Switching characteristics (See Figures 13 and 14 for the measurement circuit and resultant waveforms)

● Switching characteristics measurement circuit

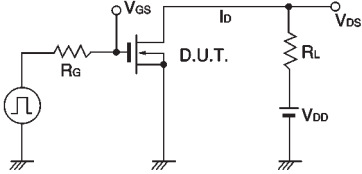

Fig.13 Switching time measurement circuit

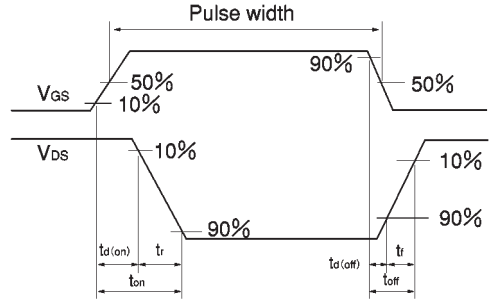

Fig.14 Switching time waveforms