

# UM1B~UM10B

Rev.C Feb.-2015

## 描述 / Descriptions

0.8A 表面贴装玻璃钝化整流桥，薄型 UMB 封装。

0.8A Surface Mount Glass Passivated Bridge Rectifier, UMB thin package.

## 特征 / Features

玻璃钝化芯片，浪涌电流大，反向电压：100V~1000V，正向电流：0.8A，适用表面贴装。无卤产品。

Glass Passivated Chip Junction, High Surge Current Capability, Reverse Voltage :100 to 1000V,

Forward Current: 0.8A, Designed for Surface Mount Application. Halogen free product.

## 用途 / Applications

一般用途。

General purpose.

## 内部等效电路 / Equivalent Circuit

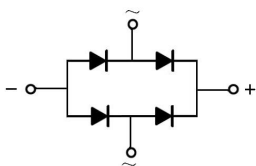

## 引脚排列 / Pinning

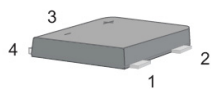

PIN	DESCRIPTION
1	Input Pin ( ~ )
2	Input Pin ( ~ )
3	Output Anode ( + )
4	Output Cathode ( - )

## 印章代码 / Marking

见印章说明。See Marking Instructions.

**极限参数 / Absolute Maximum Ratings(Ta=25°C)**

参数 Parameter	符号 Symbol	数值 Rating						单位 Unit
		UM1B	UM2B	UM4B	UM6B	UM8B	UM10B	
Maximum Repetitive Peak Reverse Voltage	V <sub>RRM</sub>	100	200	400	600	800	1000	V
Maximum RMS voltage	V <sub>RMS</sub>	70	140	280	420	560	700	V
Maximum DC Blocking Voltage	V <sub>DC</sub>	100	200	400	600	800	1000	V
Average Rectified Output Current at Ta = 40°C	I <sub>o</sub>	0.8						A
Peak Forward Surge Current 8.3 ms Single Half Sine Wave Superimposed on Rated Load (JEDEC Method)	I <sub>FSM</sub>	25						A
Typical Junction Capacitance <sup>(Note1)</sup>	C <sub>i</sub>	13						pF
Typical Thermal Resistance <sup>(Note2)</sup>	R <sub>θJA</sub>	180						°C/W
Operating and Storage Temperature Range	T <sub>j</sub> , T <sub>stg</sub>	-55~150						°C

Note:

1. Measured at 1MHz and applied reverse voltage of 4 V D.C.
2. P.C.B. mounted with 4x0.1x0.1"(4x2.54x2.54mm) copper pad areas.

**电性能参数 / Electrical Characteristics(Ta=25°C)**

参数 Parameter	符号 Symbol	测试条件 Test Conditions	数值 Rating	单位 Unit
Forward Voltage per element	V <sub>F</sub>	I <sub>F</sub> =0.4A	1.0	V
		I <sub>F</sub> =0.8A	1.1	
Maximum DC Reverse Current at Maximum DC Blocking Voltage	I <sub>R</sub>	T <sub>a</sub> =25°C	5.0	μA
		T <sub>a</sub> =125°C	100	

电参数曲线图 / Electrical Characteristic Curve

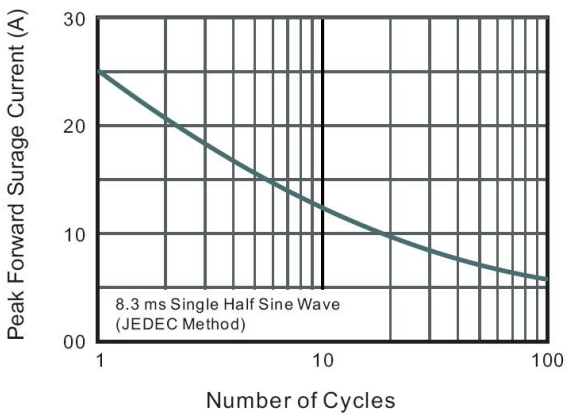
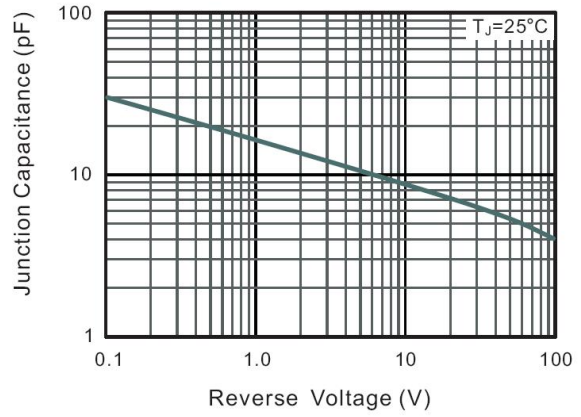
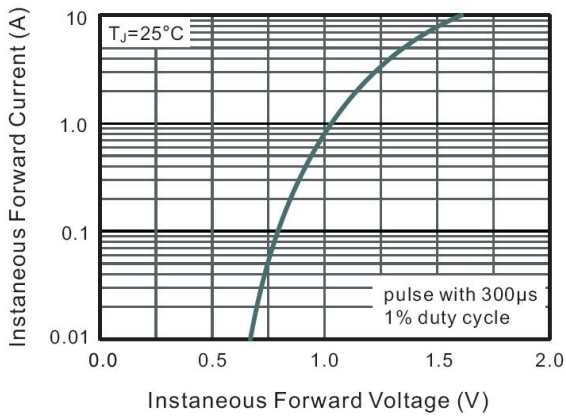
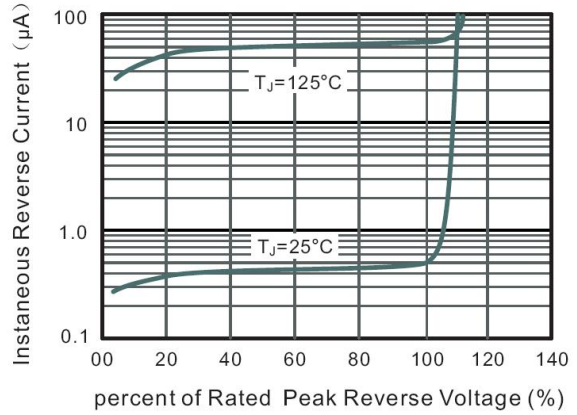
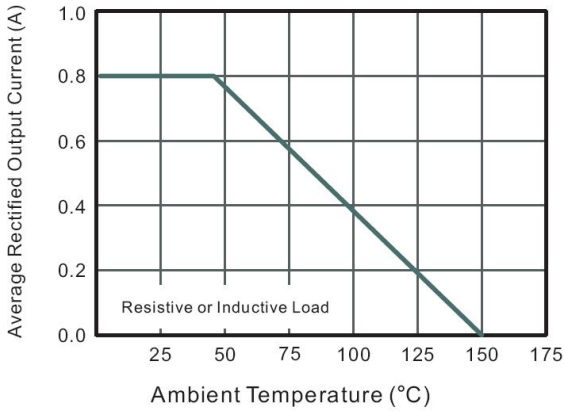

外形尺寸图 / Package Dimensions

UMB

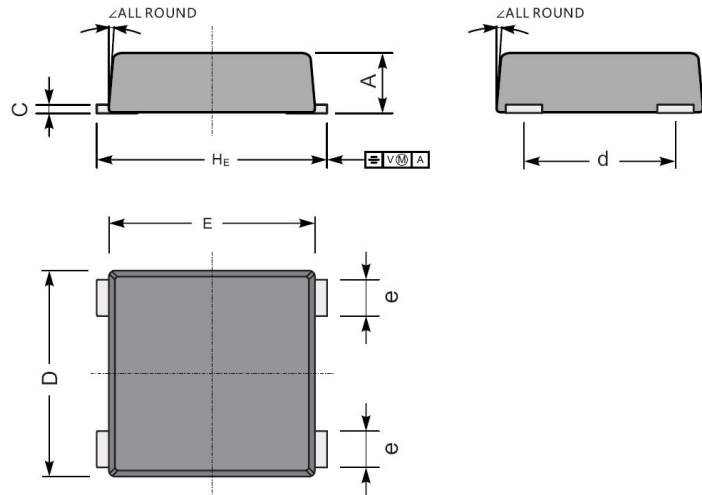

UMB mechanical data

UNIT		A	C	D	E	H <sub>E</sub>	d	e	∠
mm	max	1.2	0.19	3.7	4.0	5.0	2.7	0.7	7°
	min	1.0	0.12	3.4	3.6	4.6	2.3	0.5	
mil	max	47	7.5	146	158	197	106	28	
	min	40	4.7	134	142	181	91	20	

## Marking

Type number	Marking code
UM1B	UM1B
UM2B	UM2B
UM4B	UM4B
UM6B	UM6B
UM8B	UM8B
UM10B	UM10B

**回流焊温度曲线图(无铅) / Temperature Profile for IR Reflow Soldering(Pb-Free)**

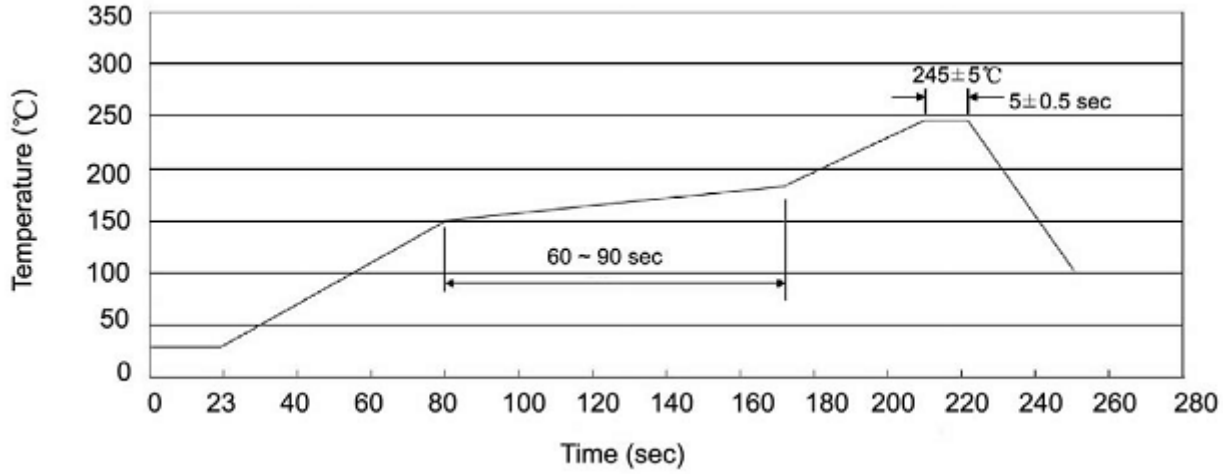

说明：

- 1、预热温度 25 ~ 150°C，时间 60 ~ 90sec;
- 2、峰值温度 245±5°C，时间持续为 5±0.5sec;
- 3、焊接制程冷却速度为 2 ~ 10°C/sec.

Note:

- 1.Preheating:25~150°C, Time:60~90sec.
- 2.Peak Temp.:245±5°C, Duration:5±0.5sec.
3. Cooling Speed: 2~10°C/sec.

**耐焊接热试验条件 / Resistance to Soldering Heat Test Conditions**

温度：260±5°C

时间：10±1 sec.

Temp.:260±5°C

Time:10±1 sec

**包装规格 / Packaging SPEC.**

卷盘包装 / REEL

Package Type 封装形式	Units 包装数量					Dimension 包装尺寸 (unit: mm <sup>3</sup> )		
	Units/Reel 只/卷盘	Reels/Inner Box 卷盘/盒	Units/Inner Box 只/盒	Inner Boxes/Outer Box 盒/箱	Units/Outer Box 只/箱	Reel	Inner Box 盒	Outer Box 箱

**使用说明 / Notices**