

### Features

- Epitaxial Planar Die Construction
- Surface Mount Package Suited for Automated Assembly
- Simplifies Circuit Design and Reduces Board Space
- Lead Free/RoHS Compliant (Note 1)
- "Green" Device (Note 2)

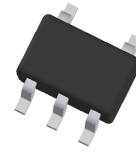

### Mechanical Data

- Case: SOT-353
- Case Material: Molded Plastic. UL Flammability Classification Rating 94V-0
- Moisture Sensitivity: Level 1 per J-STD-020C
- Terminal Connections: See Diagram
- Terminals: Finish – Matte Tin Annealed Over Alloy 42 Leadframe. Solderable per MIL-STD-202, Method 208
- Marking Information: See Page 4
- Ordering Information: See Page 4
- Weight: 0.006 grams (approximate)

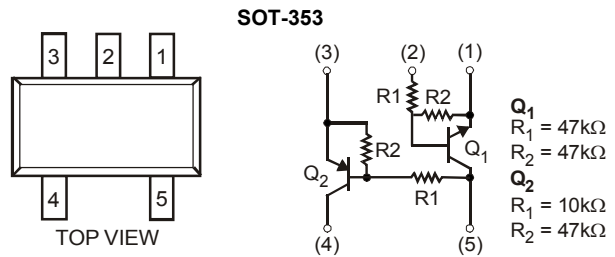

### Maximum Ratings, Total Device @ $T_A = 25^\circ C$ unless otherwise specified

Characteristic	Symbol	Value	Unit
Power Dissipation (Note 3)	$P_D$	150	mW
Thermal Resistance, Junction to Ambient Air (Note 3)	$R_{\theta JA}$	833	$^\circ C/W$
Operating and Storage Temperature Range	$T_j, T_{STG}$	-55 to +150	$^\circ C$

### Maximum Ratings, Pre-Biased NPN Transistor, $Q_1$ @ $T_A = 25^\circ C$ unless otherwise specified

Characteristic	Symbol	Value	Unit
Supply Voltage	$V_{CC}$	50	V
Input Voltage	$V_{IN}$	-10 to +40	V
Output Current	$I_O$	30	mA
Collector Current	$I_{C(MAX)}$	100	mA

### Maximum Ratings, Pre-Biased PNP Transistor, $Q_2$ @ $T_A = 25^\circ C$ unless otherwise specified

Characteristic	Symbol	Value	Unit
Supply Voltage	$V_{CC}$	-50	V
Input Voltage	$V_{IN}$	-40 to +6	V
Output Current	$I_O$	-100	mA
Collector Current	$I_{C(MAX)}$	-100	mA

- Notes:
1. No purposefully added lead.
  2. Diodes Inc.'s "Green" policy can be found on our website at [http://www.diodes.com/products/lead\\_free/index.php](http://www.diodes.com/products/lead_free/index.php).
  3. Device mounted on FR-4 PCB; pad layout as shown on Diodes Inc. suggested pad layout document AP02001, which can be found on our website at <http://www.diodes.com/datasheets/ap02001.pdf>.

## Electrical Characteristics, Pre-Biased NPN Transistor, Q<sub>1</sub> @T<sub>A</sub> = 25°C unless otherwise specified

Characteristic	Symbol	Min	Typ	Max	Unit	Test Condition
Input Voltage	V <sub>I(off)</sub>	—	—	0.5	V	V <sub>CC</sub> = 5V, I <sub>O</sub> = 100μA
	V <sub>I(on)</sub>	3	—	—	V	V <sub>O</sub> = 0.3V, I <sub>O</sub> = 2mA
Output Voltage	V <sub>O(on)</sub>	—	0.1	0.3	V	I <sub>O</sub> /I <sub>I</sub> = 10mA/0.5 mA
Input Current	I <sub>I</sub>	—	—	0.18	mA	V <sub>I</sub> = 5V
Output Current	I <sub>O(off)</sub>	—	—	0.5	μA	V <sub>CC</sub> = 50V, V <sub>I</sub> = 0V
DC Current Gain	G <sub>I</sub>	68	—	—	—	V <sub>O</sub> = 5V, I <sub>O</sub> = 5mA
Gain-Bandwidth Product	f <sub>T</sub>	—	250	—	MHz	V <sub>CE</sub> = 10V, I <sub>E</sub> = -5mA, f = 100MHz*
Input Resistance	R <sub>1</sub>	32.9	47	61.1	kΩ	—
Resistance Ratio	R <sub>2</sub> /R <sub>1</sub>	0.8	1	1.2	—	—

\*Characteristic of Transistor – for reference only.

## Electrical Characteristics, Pre-Biased PNP Transistor, Q<sub>2</sub> @T<sub>A</sub> = 25°C unless otherwise specified

Characteristic	Symbol	Min	Typ	Max	Unit	Test Condition
Input Voltage	V <sub>I(off)</sub>	—	—	-0.3	V	V <sub>CC</sub> = -5V, I <sub>O</sub> = -100μA
	V <sub>I(on)</sub>	-1.4	—	—	V	V <sub>O</sub> = -0.3V, I <sub>O</sub> = -1mA
Output Voltage	V <sub>O(on)</sub>	—	-0.1	-0.3	V	I <sub>O</sub> /I <sub>I</sub> = -5mA/-0.25 mA
Input Current	I <sub>I</sub>	—	—	-0.88	mA	V <sub>I</sub> = -5V
Output Current	I <sub>O(off)</sub>	—	—	-0.5	μA	V <sub>CC</sub> = -50V, V <sub>I</sub> = 0V
DC Current Gain	G <sub>I</sub>	68	—	—	—	V <sub>O</sub> = -5V, I <sub>O</sub> = -5mA
Gain-Bandwidth Product	f <sub>T</sub>	—	250	—	MHz	V <sub>CE</sub> = -10V, I <sub>E</sub> = 5mA, f = 100MHz*
Input Resistance	R <sub>1</sub>	7	10	13	kΩ	—
Resistance Ratio	R <sub>2</sub> /R <sub>1</sub>	3.7	4.7	5.7	—	—

\*Characteristic of Transistor – for reference only.

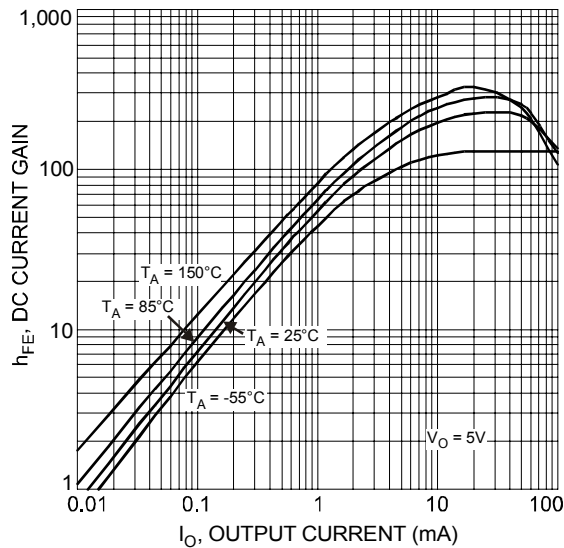

Fig. 1 Typical DC Current Gain vs. Output Current (Q<sub>1</sub>, NPN)

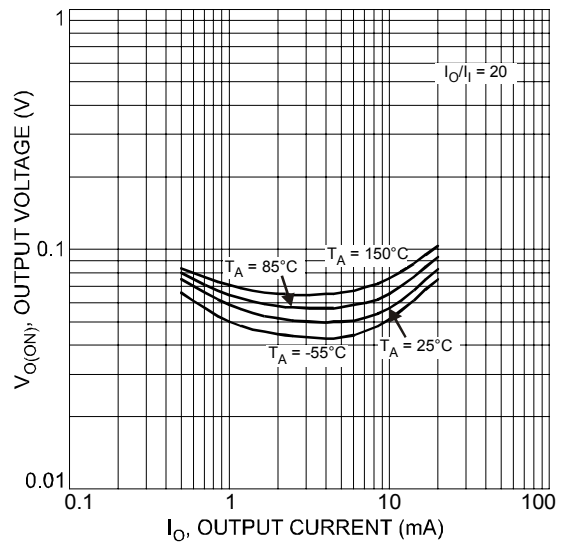

Fig. 2 Typical Output Voltage vs. Output Current (Q<sub>1</sub>, NPN)

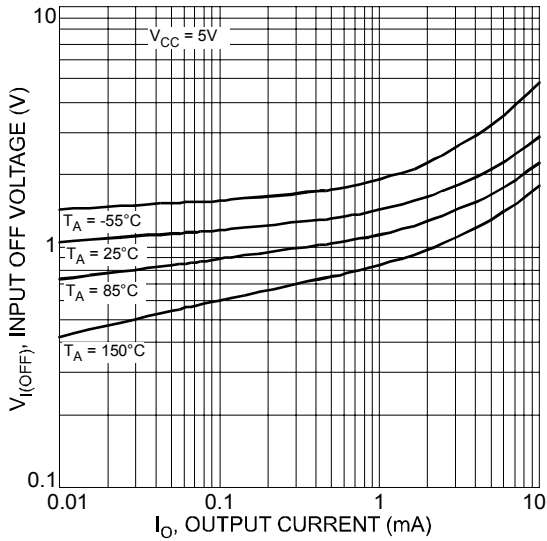

Fig. 3 Typical Input OFF Voltage vs. Output Current (Q1, NPN)

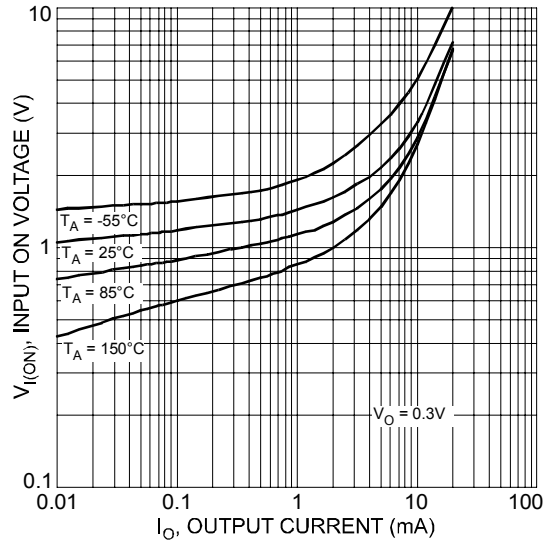

Fig. 4 Typical Input ON Voltage vs. Output Current (Q1, NPN)

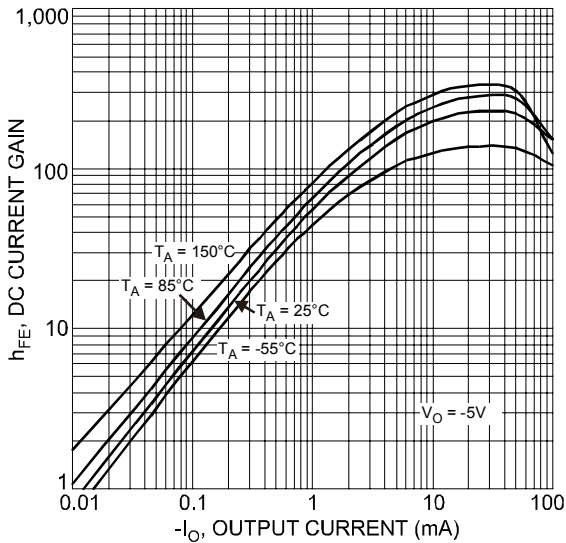

Fig. 5 Typical DC Current Gain vs. Output Current (Q2, PNP)

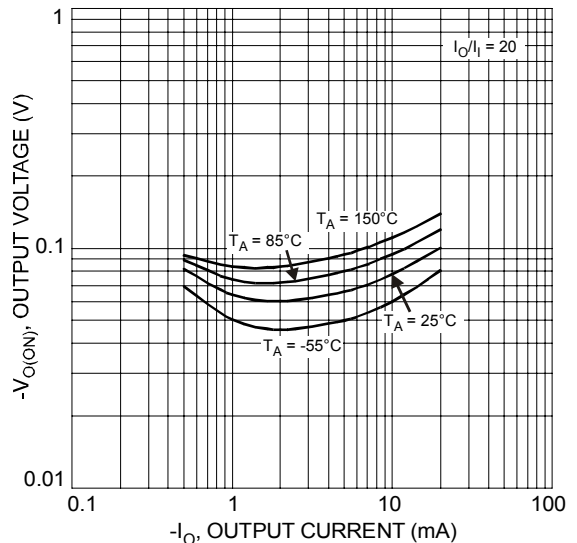

Fig. 6 Typical Output Voltage vs. Output Current (Q2, PNP)

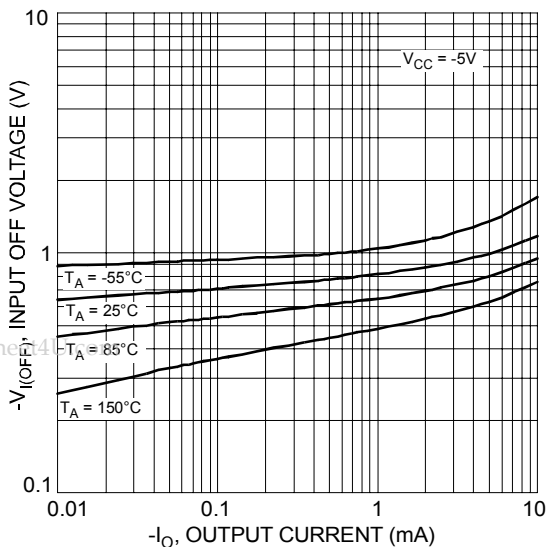

Fig. 7 Typical Input OFF Voltage vs. Output Current (Q2, PNP)

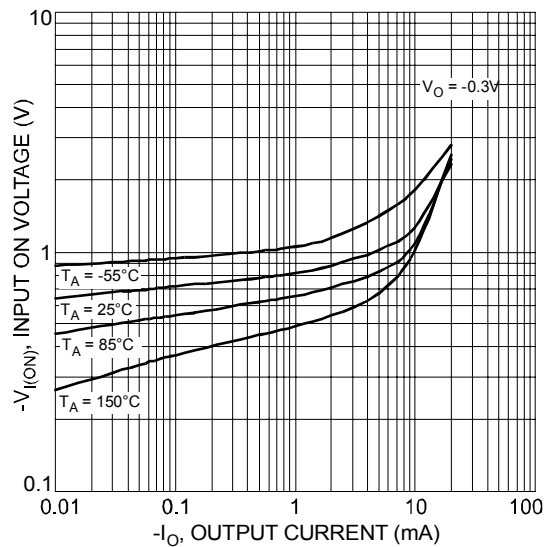

Fig. 8 Typical Input ON Voltage vs. Output Current (Q2, PNP)

## Ordering Information (Note 4)

Device	Packaging	Shipping
UMC4N-7	SOT-353	3000/Tape & Reel

Notes: 4. For packaging details, go to our website at <http://www.diodes.com/datasheets/ap02007.pdf>.

## Marking Information

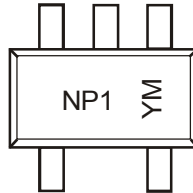

NP1 = Product Type Marking Code  
 YM = Date Code Marking  
 Y = Year ex: U = 2007  
 M = Month ex: 9 = September

### Date Code Key

Year Code	2007	2008	2009	2010	2011	2012
Year Code	U	V	W	X	Y	Z

Month Code	Jan	Feb	Mar	Apr	May	Jun	Jul	Aug	Sep	Oct	Nov	Dec
Month Code	1	2	3	4	5	6	7	8	9	O	N	D

## Package Outline Dimensions

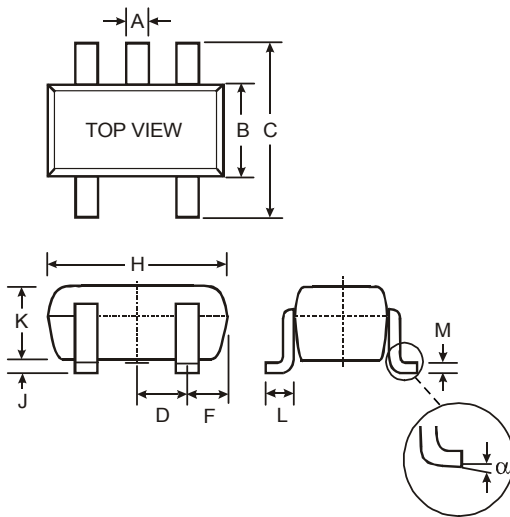

SOT-353		
Dim	Min	Max
A	0.10	0.30
B	1.15	1.35
C	2.00	2.20
D	0.65 Nominal	
F	0.30	0.40
H	1.80	2.20
J	—	0.10
K	0.90	1.00
L	0.25	0.40
M	0.10	0.25
α	0°	8°
All Dimensions in mm		

### IMPORTANT NOTICE

Diodes Incorporated and its subsidiaries reserve the right to make modifications, enhancements, improvements, corrections or other changes without further notice to any product herein. Diodes Incorporated does not assume any liability arising out of the application or use of any product described herein; neither does it convey any license under its patent rights, nor the rights of others. The user of products in such applications shall assume all risks of such use and will agree to hold Diodes Incorporated and all the companies whose products are represented on our website, harmless against all damages.

### LIFE SUPPORT

Diodes Incorporated products are not authorized for use as critical components in life support devices or systems without the expressed written approval of the President of Diodes Incorporated.