

## **Specification**

**UP056D01**

**5.6" NTSC Color TFT**

**(320 x RGB) x 234**

# UNIPAC OPTOELECTRONICS CORPORATION

Spec. No. 413-210-088

Version : 0

Total pages : 19

Date : 1999.11.01

## UP056D01 COLOR TFT-LCD PRELIMINARY SPECIFICATION

**MODEL NAME: UP056D01**

The content of this technical information is subject to change without notice. Please contact Unipac or its agent for further information.

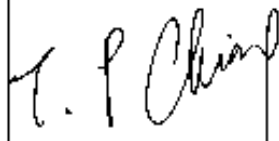
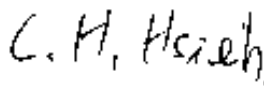
Approved by	Checked by	Prepared by
		

**Contents:**

- A. Physical specification..... P3**
- B. Electrical specifications..... P4**
  - 1. Pin assignment..... P4
    - a. TFT-LCD panel driving section..... P4
    - b. Backlight driving section..... P5
  - 2. Absolute maximum ratings..... P5
  - 3. Electrical characteristics..... P6
    - a. Typical operating conditions..... P6
    - b. Current consumption..... P6
    - c. Backlight driving conditions..... P6
  - 4. AC Timing..... P7
    - a. Timing conditions..... P7
    - b. Timing diagram..... P7
- C. Optical specifications..... P8**
- D. Reliability test items..... P10**
- E. Packing form..... P11**

**Appendix:**

Fig.1 Outline dimension of TFT-LCD module. .... **P12**  
Fig.2 Sampling clock timing. .... **P13**  
Fig.3 Horizontal display timing range. .... **P14**  
Fig.4-(a) Horizontal timing. .... **P15**  
Fig.4-(b) Detail horizontal timing. .... **P16**  
Fig.5 Vertical shift clock timing. .... **P17**  
Fig.6-(a) Vertical timing (From up to down). .... **P18**  
Fig.6-(b) Vertical timing (From down to up) .... **P19**

The numbers with parenthesis in the following specification are the estimated values, please contact Unipac or its agent for the updated information.

### A. Physical specifications

NO.	Item	Specification	Remark
1	Display resolution(dot)	960(W) × 234(H)	
2	Active area(mm)	113.3(W) × 84.7(H)	
3	Screen size(inch)	5.6(Diagonal)	
4	Dot pitch(mm)	0.118(W) × 0.362(H)	
5	Color configuration	R. G. B. stripe	
6	Overall dimension(mm)	126.5(W) × 100(H) × (6.8)(D)	Note 1
7	Weight(g)	(180 ± 20)	

Note 1: Refer to Fig. 1

## B. Electrical specifications

### 1.Pin assignment

#### a. TFT-LCD panel driving section

Pin no	Symbol	I/O	Description	Remark
1	GND	-	Ground for logic circuit	
2	V <sub>CC</sub>	I	Supply voltage of logic control circuit for scan driver	
3	V <sub>GL</sub>	I	Negative power for scan driver	
4	V <sub>GH</sub>	I	Positive power for scan driver	
5	STVR	I/o	Vertical start pulse	Note 1
6	STVL	I/o	Vertical start pulse	Note 1
7	CKV	I	Shift clock input for scan driver	
8	U/D	I	UP/DOWN scan control input	Note 1,2
9	OEV	I	Output enable input for scan driver	
10	VCOM	I	Common electrode driving signal	
11	VCOM	I	Common electrode driving signal	
12	L/R	I	LEFT/RIGHT scan control input	Note 1,2
13	Q1H	I	Analog signal rotate input	
14	OEH	I	Output enable input for data driver	
15	STHL	I/o	Start pulse for horizontal scan line	Note 1
16	STHR	I/o	Start pulse for horizontal scan line	Note 1
17	CPH3	I	Sampling and shifting clock pulse for data driver	
18	CPH2	I	Sampling and shifting clock pulse for data driver	
19	CPH1	I	Sampling and shifting clock pulse for data driver	
20	V <sub>CC</sub>	I	Supply voltage of logic control circuit for data driver	
21	GND	-	Ground for logic circuit	
22	VR	I	Alternated video signal input(Red)	
23	VG	I	Alternated video signal input(Green)	
24	VB	I	Alternated video signal input(Blue)	
25	AV <sub>DD</sub>	I	Supply voltage for analog circuit	
26	AV <sub>SS</sub>	-	Ground for analog circuit	

Note 1: Selection of scanning mode (please refer to the following table)

Setting of scan control input		IN/OUT state For start pulse				Scanning direction
U/D	L/R	STVR	STVL	STHR	STHL	
GND	V <sub>CC</sub>	OUT	IN	OUT	IN	From up to down, and from left to right.
V <sub>CC</sub>	GND	IN	OUT	IN	OUT	From down to up, and from right to left.
GND	GND	OUT	IN	IN	OUT	From up to down, and from right to left.
V <sub>CC</sub>	V <sub>CC</sub>	IN	OUT	OUT	IN	From down to up, and from left to right.

IN: Input; OUT: Output.

Note 2 : Definition of scanning direction.

Refer to figure as below:

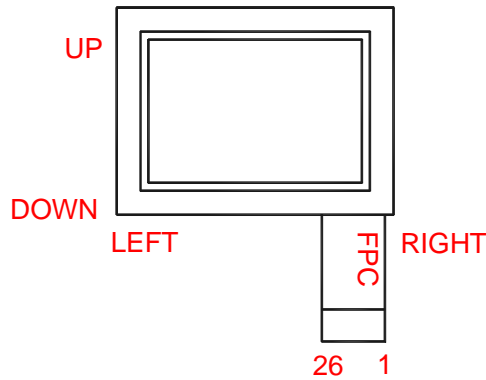

b. Backlight driving section( Refer to Fig. 1)

No.	Symbol	I/O	Description	Remark
1	HI	i	Power supply for backlight unit (High voltage)	
2	GND	-	Ground for backlight unit	

2. Absolute maximum ratings

Item	Symbol	Condition	Min.	Max.	Unit	Remark
Power voltage	V <sub>CC</sub>	GND=0	-0.3	7	V	
	AV <sub>DD</sub>	AV <sub>SS</sub> =0	-0.3	7	V	
	V <sub>GH</sub>	GND=0	-0.3	18	V	
	V <sub>GL</sub>		-15	0.3	V	
	V <sub>GH</sub> -V <sub>GL</sub>		-	31	V	
Input signal voltage	V <sub>i</sub>		-0.3	AV <sub>DD</sub> +0.3	V	Note 1
	V <sub>I</sub>		-0.3	V <sub>CC</sub> +0.3	V	Note 2
	VCOM		-2.9	5.2	V	
Operating temperature	Topa		0	60	°C	Ambient temperature
Storage temperature	Tstg		-25	80	°C	Ambient temperature

Note 1: VR, VG, VB

Note 2: STHL, STHR, Q1H,OEH,L/R,CPH1~CPH3, STVR, STVL,OEV,CKV,U/D.

## 3. Electrical characteristics

## a. Typical operating conditions (GND=AVss=0V, Note 5 )

Item	Symbol	Min.	Typ.	Max.	Unit	Remark
Power supply	$V_{CC}$	4.8	5	5.2	V	
	$AV_{DD}$	4.8	5	5.2	V	
	$V_{GH}$	14.3	15	15.7	V	
	$V_{GLAC}$	-	(5)	-	Vp-p	AC component of $V_{GL}$ . Note 1
	$V_{GLDC}$	-10.5	-10	-9.5	V	DC component of $V_{GL}$ .
Video signal Amplitude (VR, VG, VB)	$V_{iA}$	AVss +0.4	-	$AV_{DD}-0.4$	V	Note 2
	$V_{iAC}$	-	3	-	V	AC component
	$V_{iDC}$	-	$AV_{DD}/2$	-	V	DC component
VCOM	$V_{CAC}$	-	(5)	-	Vp-p	AC component, Note 3
	$V_{CDC}$	TBD	TBD	TBD	V	DC component
Input Signal voltage	H Level	$V_{IH}$	$0.8V_{CC}$	-	$V_{CC}$	Note 4
	L Level	$V_{IL}$	0	-	$0.2V_{CC}$	

Note 1: The same phase and amplitude with common electrode driving signal(VCOM).

Note 2: Refer to Fig.4-(a)

Note 3: The brightness of LCD panel could be adjusted by the adjustment of the AC component of VCOM.

Note 4: STHL, STHR, Q1H, OEH, L/R, CPH1~CPH3, STVR, STVL, OEV, CKV, U/D.

Note 5: Be sure to apply GND,  $V_{CC}$  and  $V_{GL}$  to the LCD first, and then apply  $V_{GH}$ .

## b. Current consumption (GND=AVss=0V)

Parameter	Symbol	Condition	Min.	Typ.	Max.	Unit	Remark
Current for driver	$I_{GH}$	$V_{GH}=15V$	-	( 0.26 )	( 0.8 )	mA	
	$I_{GL}$	$V_{GL}=-10V$	-	( -0.41 )	( -1 )	mA	
	$I_{CC}$	$V_{CC}=5V$	-	( 6.5 )	( 12 )	mA	
	$I_{DD}$	$AV_{DD}=5V$	-	( 10 )	( 20 )	mA	
	$I_{VCOM}$	$V_{CAC}=5V$	-	TBD	TBD	mA	
	$I_{LI1}$	-	-10	-	10	$\mu A$	Note 1

Note 1: Logic Input Leakage Current

## c. Backlight driving conditions

Parameter	Symbol	Min.	Typ.	Max.	Unit	Remark
Lamp voltage	$V_L$	TBD	(580)	(638)	Vrms	Note 3
Lamp current	$I_L$	( 5 )	6	(7)	mArms	
Frequency	$F_L$	-	60	-	kHz	Note 3,4
Lamp starting voltage	$V_S$	-	(930)	(1150)	Vrms	Note 1,3,5
		-	(1100)	(1150)	Vrms	Note 2,3,5

Note 1:  $T_a = 25^\circ C$ .

Note 2:  $T_a = 0^\circ C$ .

Note 3: Reference value, correct value is subject to final backlight specification which will be decided in the future.



Note 4: The lamp frequency should be selected as different as possible from display horizontal synchronous signal to avoid interference.

Note 5: For starting the backlight unit, the output voltage of DC/AC's transformer should be larger than the maximum lamp starting voltage.

#### 4. AC Timing

##### a. Timing conditions

Parameter	Symbol	Min.	Typ.	Max.	Unit.	Remark
Rising time	$t_{r1}$	-	-	60	ns	CPH1~CPH3
Falling time	$t_{f1}$	-	-	60	ns	CPH1~CPH3
Rising time	$t_{r2}$	-	-	120	ns	CKV
Falling time	$t_{f2}$	-	-	120	ns	CKV
High and low level pulse width	$t_{CPH}$	150	154	158	ns	CPH1~CPH3
CPH pulse duty	$t_{CWH}$	40	50	60	%	CPH1~CPH3
CPH pulse delay	$t_{C12}$ $t_{C23}$ $t_{C31}$	30	$t_{CPH}/3$	$t_{CPH}/2$	ns	CPH1~CPH3
STH setup time	$t_{SUH}$	20	-	-	ns	STHR,STHL
STH hold time	$t_{HDH}$	20	-	-	ns	STHR,STHL
STH pulse width	$t_{STH}$	-	1	-	$t_{CPH}$	STHR,STHL
STH period	$t_H$	61.5	63.5	65.5	$\mu s$	STHR,STHL
OEH pulse width	$t_{OEH}$	-	7	-	$t_{CPH}$	OEH
Sample and hold disable time	$t_{DIS1}$	-	55	-	$t_{CPH}$	
OEV pulse width	$t_{OEV}$	-	27	-	$t_{CPH}$	OEV
CKV pulse width	$t_{CKV}$	-	41	-	$t_{CPH}$	CKV
Clean enable time	$t_{DIS2}$	-	16	-	$t_{CPH}$	
Horizontal display start	$t_{SH}$	-	0	-	$t_{CPH}/3$	
Horizontal display timing range	$t_{DH}$	-	960	-	$t_{CPH}/3$	
STV setup time	$t_{SUV}$	400	-	-	ns	STVL,STVR
STV hold time	$t_{HDV}$	400	-	-	ns	STVL,STVR
STV pulse width	$t_{STV}$	-	-	1	$t_H$	STVL,STVR
Horizontal lines per field	$t_V$	256	262	268	$t_H$	Note 1
Vertical display start	$t_{SV}$		3	-	$t_H$	
Vertical display timing range	$t_{DV}$		234	-	$t_H$	
VCOM rising time	$t_{rCOM}$		-	5	$\mu s$	
VCOM falling time	$t_{fCOM}$		-	5	$\mu s$	
VCOM delay time	$t_{DCOM}$		-	3	$\mu s$	
RGB delay time	$t_{DRGB}$		-	1	$\mu s$	

Note 1: Please don't use odd horizontal lines to drive LCD panel for both odd and even field simultaneously.

##### b. Timing diagram

Please refer to the attached drawing, from Fig.2 to Fig.6.

**C. Optical specification (Note 1,Note 2, Note 3 )**

Item		Symbol	Condition	Min.	Typ.	Max.	Unit	Remark
Response time	Rise	Tr	$\theta = 0^\circ$	-	15	30	Ms	Note 4,6
	Fall	Tf		-	20	40	Ms	
Contrast ratio		CR	At optimized viewing angle	100	150	-		Note 5,6
Viewing angle	Top		$CR \geq 10$	10	-	-	deg.	Note 6,7
	Bottom			30	-	-		
	Left			45	-	-		
	Right			45	-	-		
Brightness			$\theta = 0^\circ$	250	300	-	nit	Note 8
White chromaticity		X	$\theta = 0^\circ$	0.25	0.30	0.35		Note 8
		Y	$\theta = 0^\circ$	0.30	0.35	0.40		

Note 1. Ambient temperature =25°C . And lamp current  $I_L = (6)mArms$ .

Note 2. To be measured in the dark room.

Note 3.To be measured on the center area of panel with a viewing cone of 1° by Topcon luminance meter BM-7, after 10 minutes operation.

Note 4. Definition of response time:

The output signals of photodetector are measured when the input signals are changed from “black” to “white”(falling time)and from “white” to “black”(rising time),respectively.

The response time is defined as the time interval between the 10% and 90% of amplitudes. Refer to figure as below.

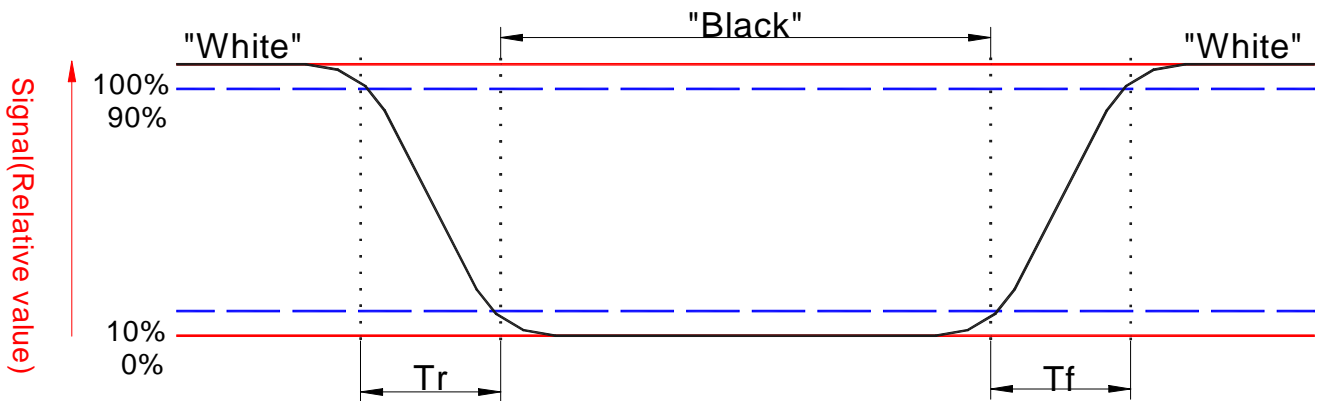

Note 5. Definition of contrast ratio:

Contrast ratio is calculated with the following formula.

$$\text{Contrast ratio (CR)} = \frac{\text{Photodetector output when LCD is at "White" state}}{\text{Photodetector output when LCD is at "Black" state}}$$

Note 6. White  $V_i = V_{i50} \mp 1.5V$

Black  $V_i = V_{i50} \pm 2.0V$

“ $\pm$ ” means that the analog input signal swings in phase with COM signal.

“ $\mp$ ” means that the analog input signal swings out of phase with COM signal.

$V_{i50}$  : The analog input voltage when transmission is 50%

The 100% transmission is defined as the transmission of LCD panel when all the input terminals of module are electrically opened.

Note 7. Definition of viewing angle:

Refer to figure as below.

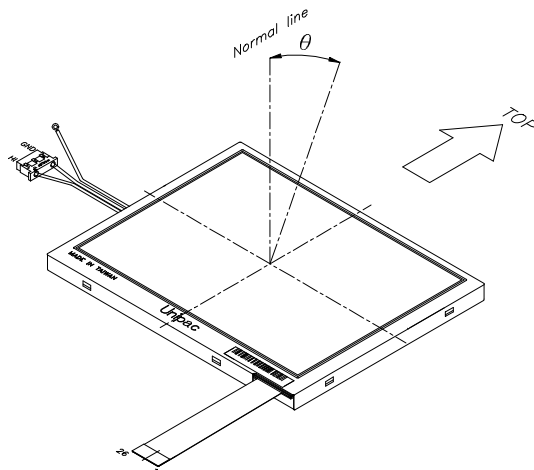

Note 8. Measured at the center area of the panel when all the input terminals of LCD panel are electrically opened.

**D. Reliability test items:**

No.	Test items	Conditions	Remark
1	High temperature storage	Ta= 80°C                      240H	
2	Low temperature storage	Ta= -25°C                      240H	
3	High temperature operation	Ta= 60°C                      240H	
4	Low temperature operation	Ta= 0°C                      240H	
5	High temperature and high humidity	Ta= 60°C, 95% RH              240H	Operation
6	Heat shock	-25°C~80°C/50 cycle 2H/cycle	Non-operation
7	Electrostatic discharge	±200V,200pF(0Ω), once for each terminal	Non-operation
8	Vibration	Frequency range : 10~55Hz Stoke : 1.5mm Sweep : 10~55Hz~10Hz 2 hours for each direction of X,Y,Z (6 hours for total)	JIS C7021, A-10 condition A
9	Mechanical shock	100G , 6ms, ±X,±Y,±Z 3 times for each direction	JIS C7021, A-7 condition C
10	Vibration (with carton)	Random vibration: 0.015G <sup>2</sup> /Hz from 5~200Hz -6dB/Octave from 200~500Hz	IEC 68-34
11	Drop (with carton)	Height: (60)cm 1 corner, 3 edges, 6 surfaces	JIS Z0202

Note: Ta: Ambient temperature.

### E.Packing form

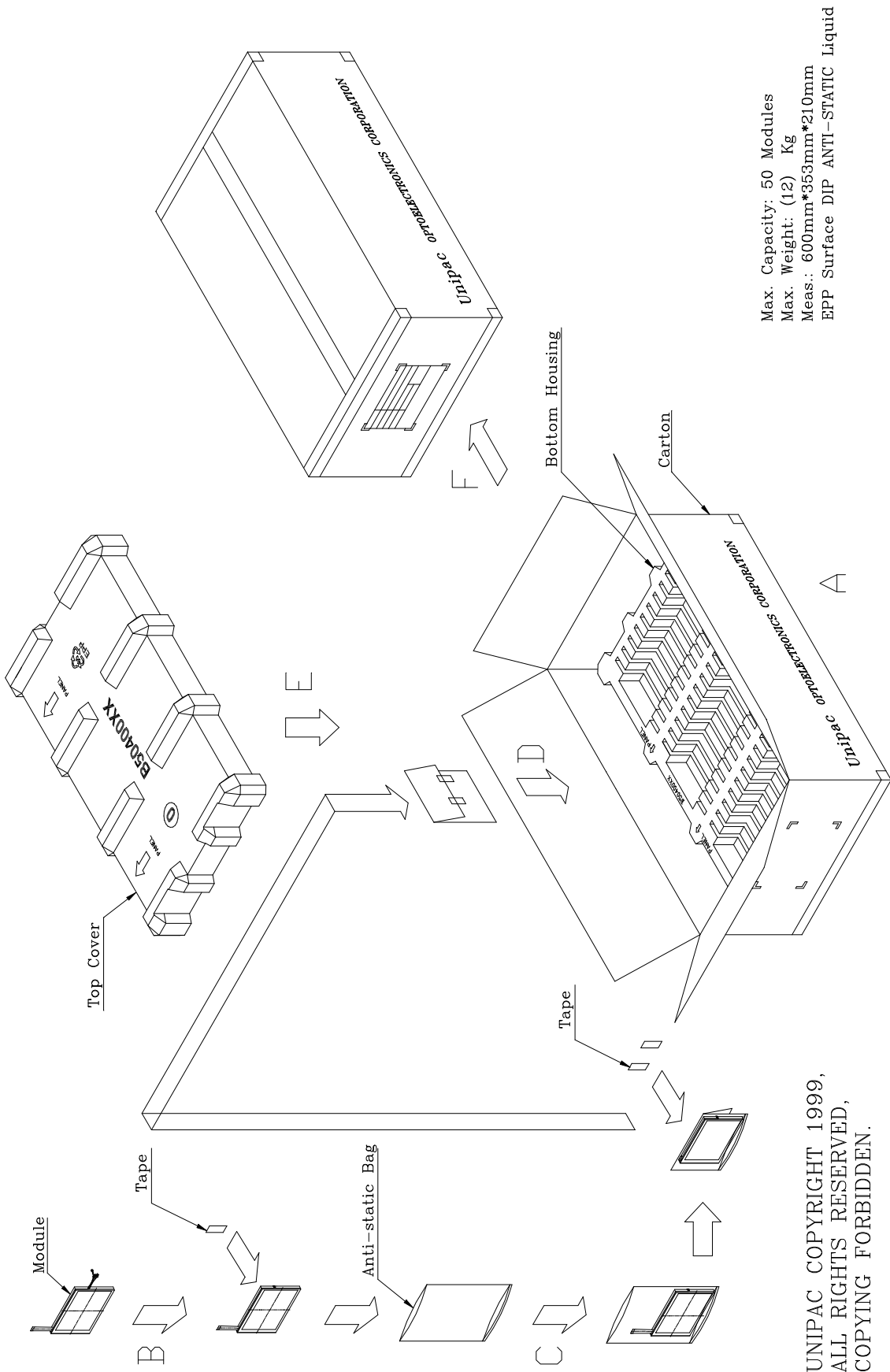

Max. Capacity: 50 Modules  
Max. Weight: (12) Kg  
Meas.: 600mm\*353mm\*210mm  
EPP Surface DIP ANTI-STATIC Liquid

UNIPAC COPYRIGHT 1999,  
ALL RIGHTS RESERVED,  
COPYING FORBIDDEN.

- NOTES:  
 1. General tolerance is  $\pm 0.30$   
 2. Bending radius of FPC should be larger than 0.6.  
 3. Unit : mm.  
 4. Glass thickness = 0.7mm

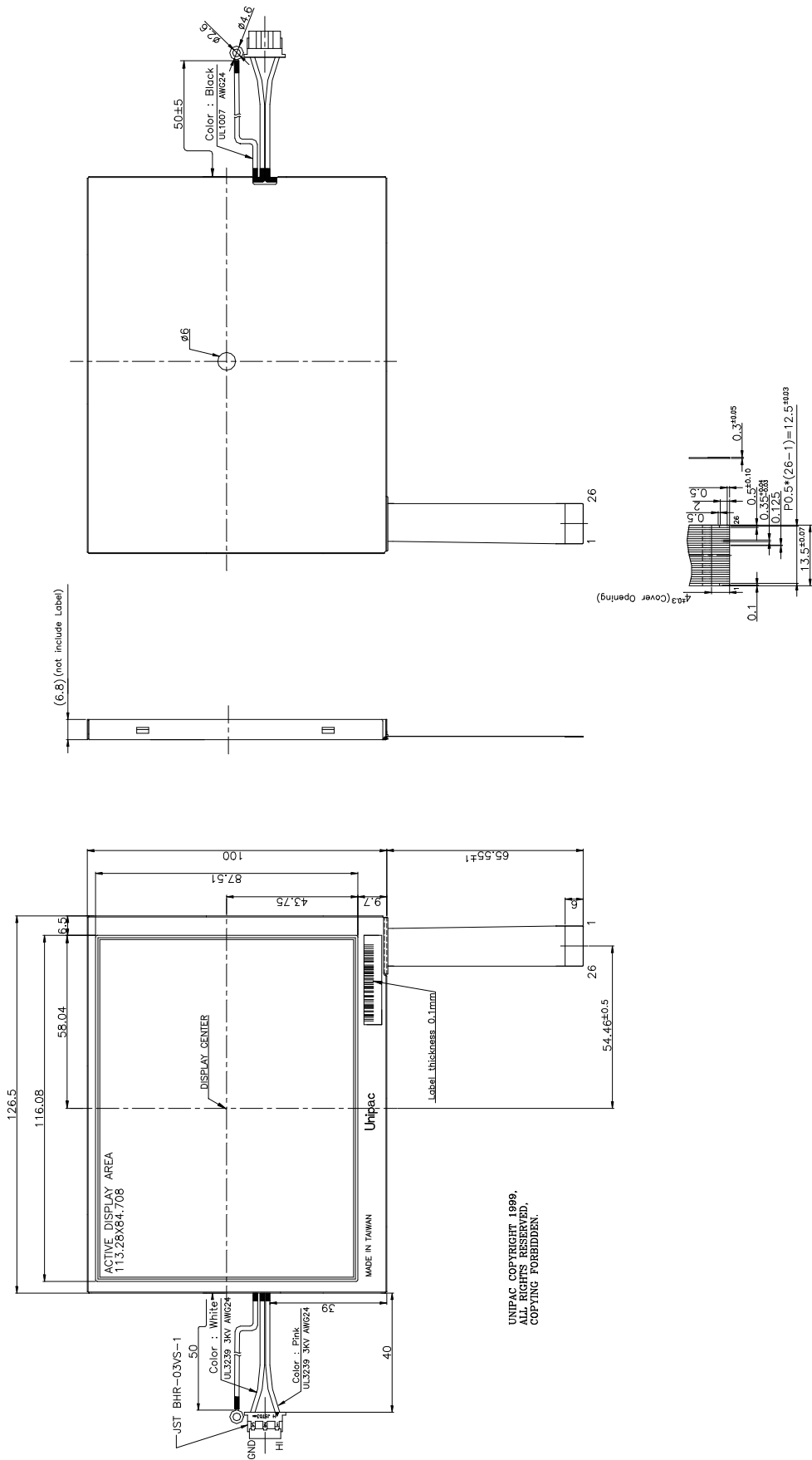

UNIPAC COPYRIGHT 1999.  
 ALL RIGHTS RESERVED.  
 COPYING FORBIDDEN.

Fig. 1 Outline dimension of TFT-LCD module

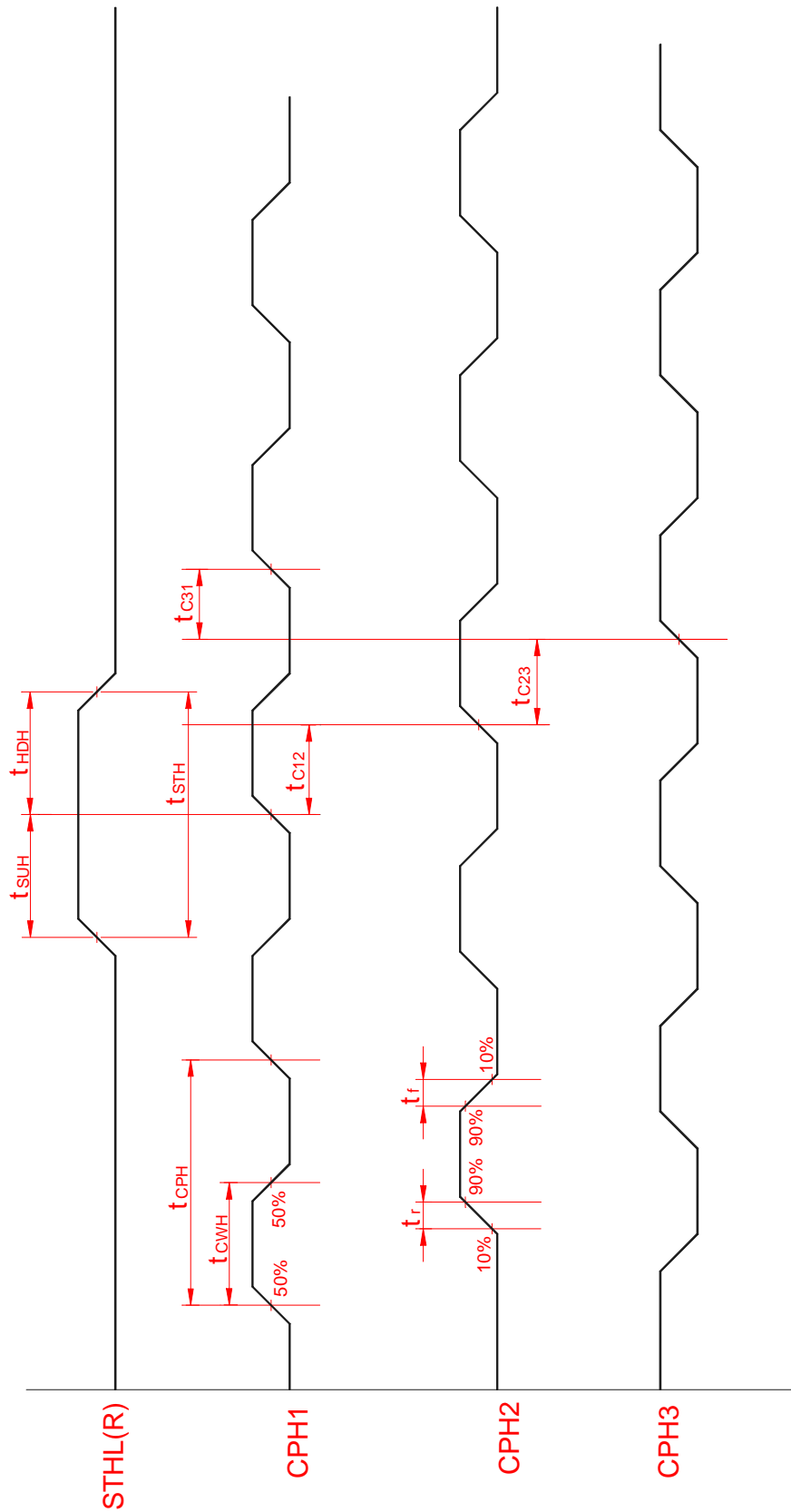

Fig. 2 Sampling clock timing

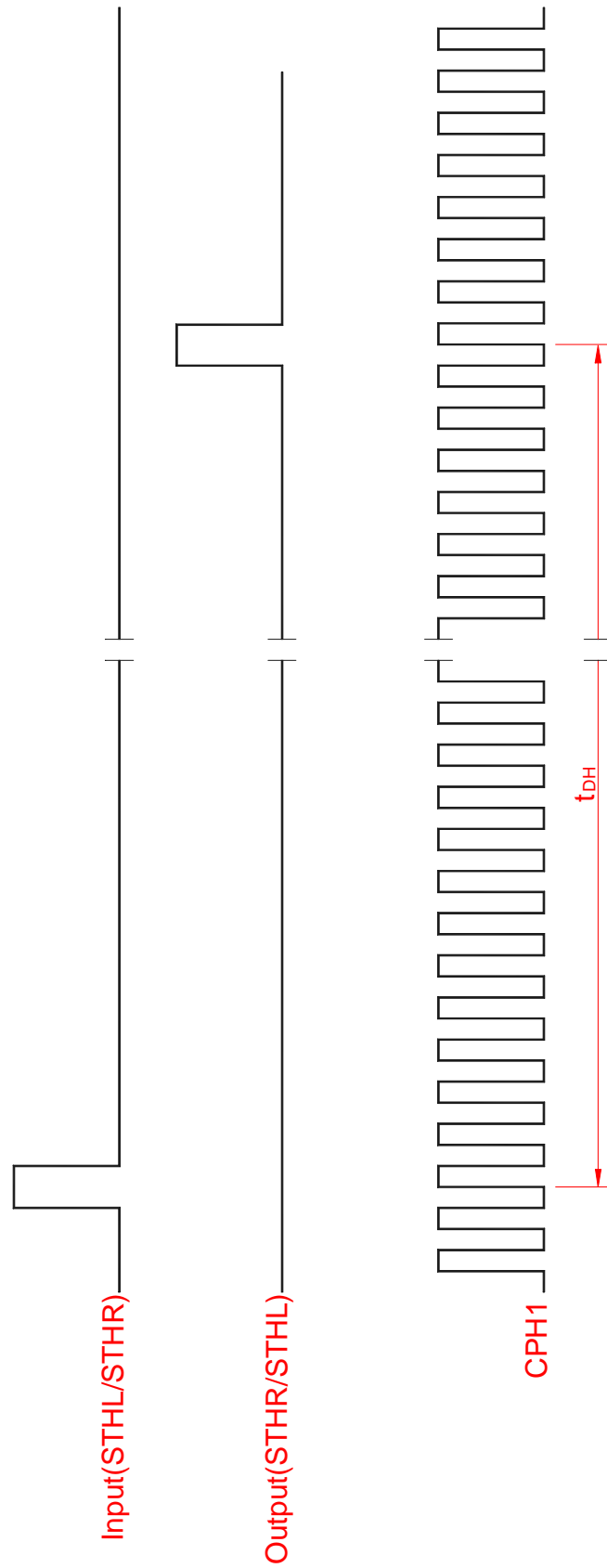

Fig. 3 Horizontal display timing range



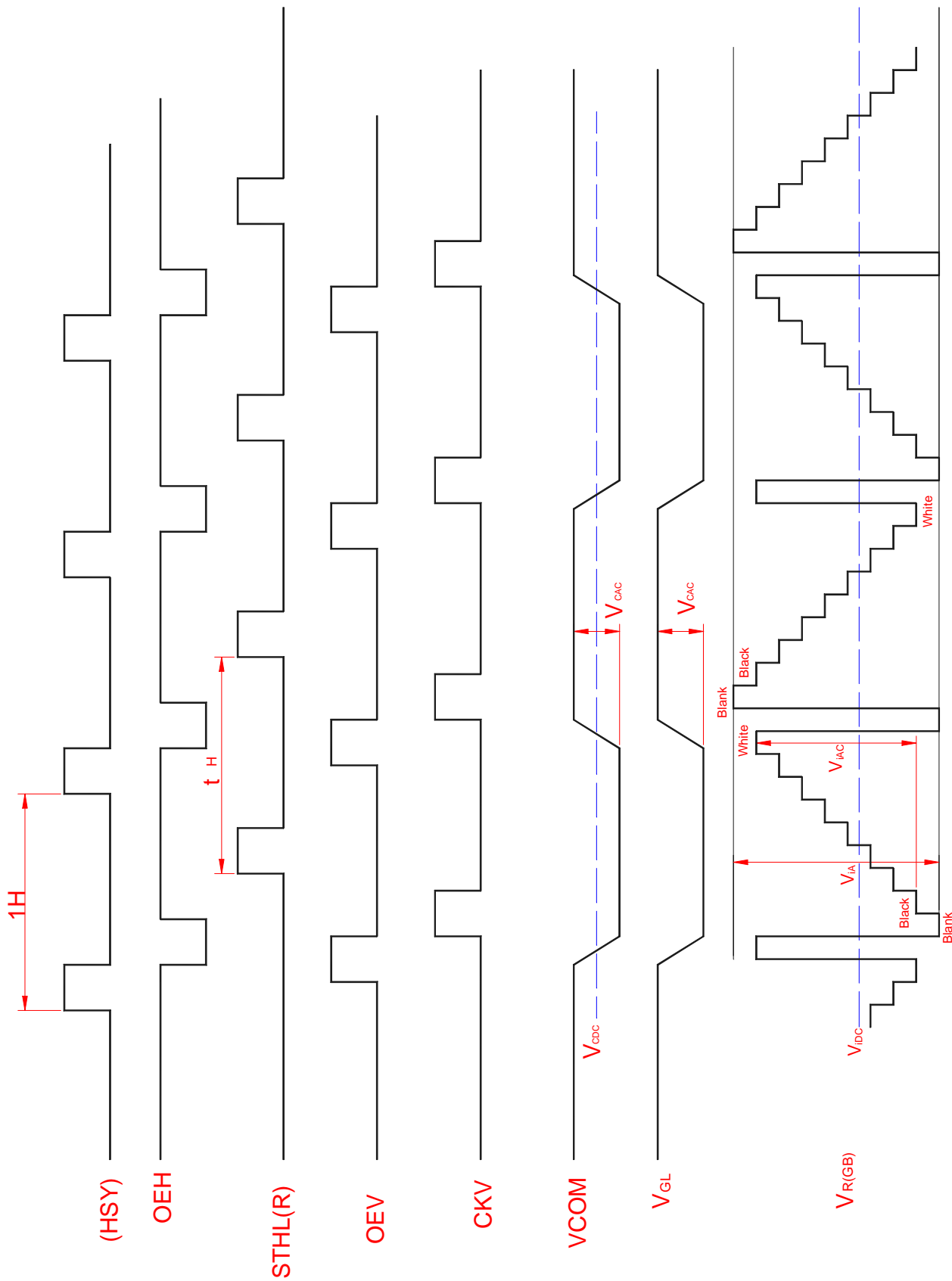
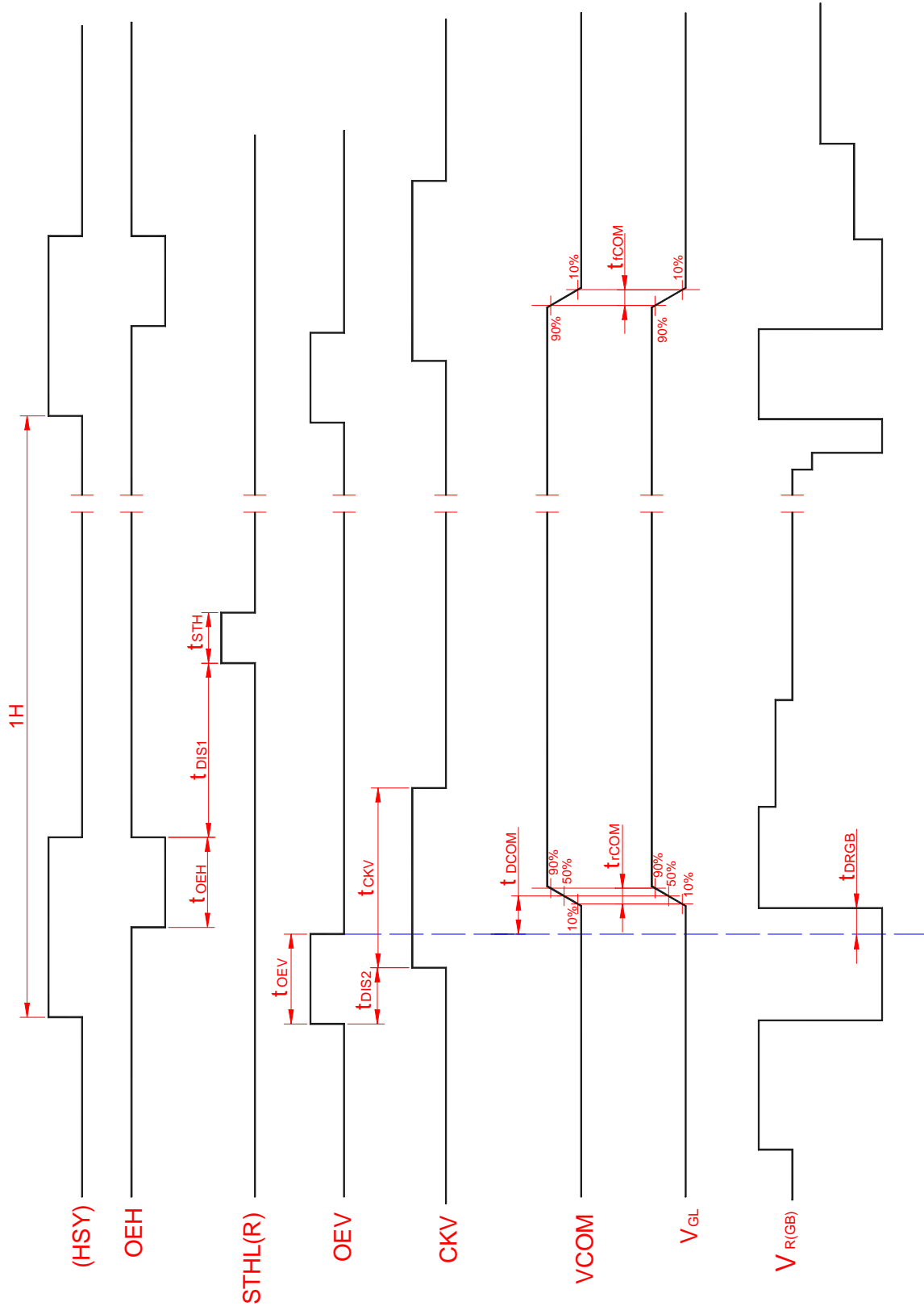

Fig.4-(a) Horizontal timing



Note: The falling edge of OEV should be synchronized with the falling edge of OEH

Fig. 4-(b) Detail horizontal timing

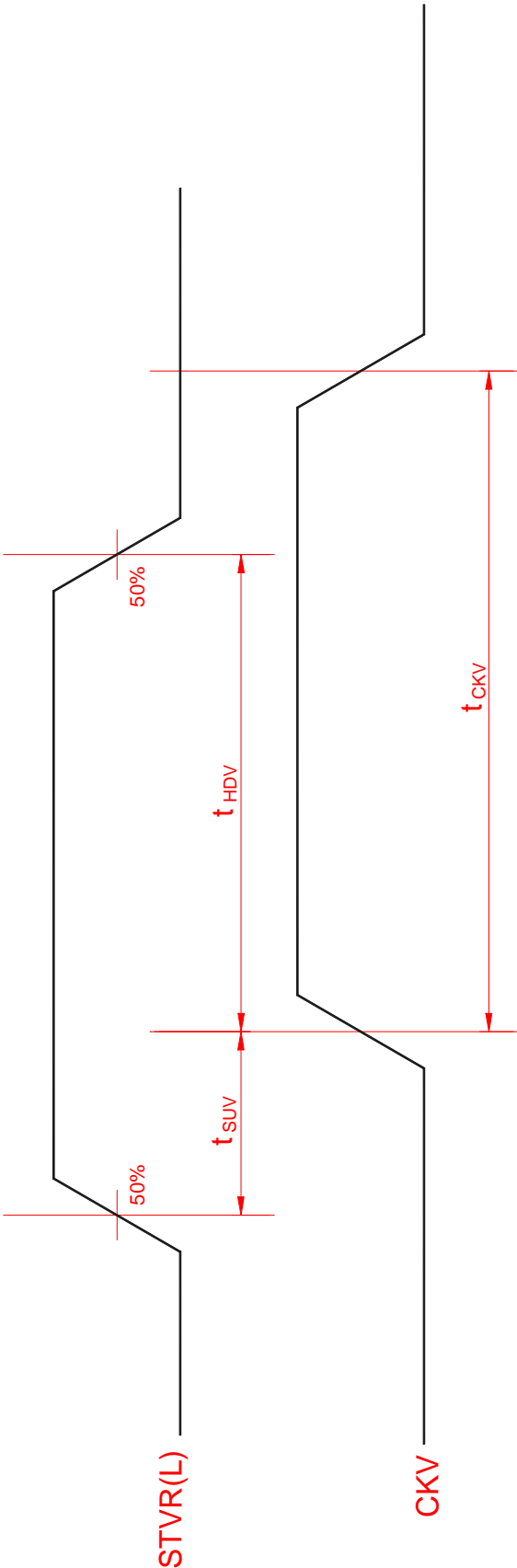

Fig.5 Vertical shift clock timing

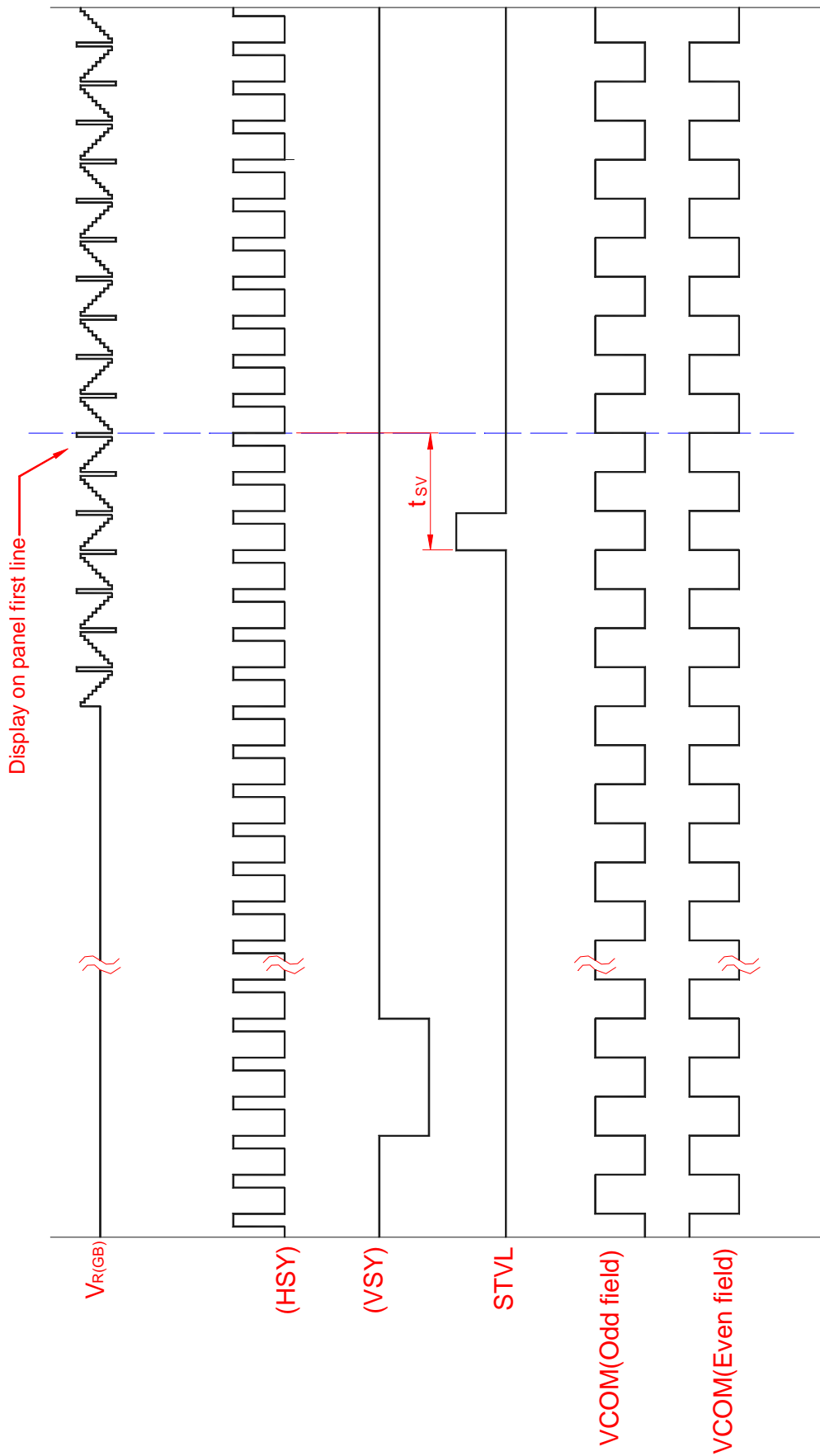

Fig.6-(a) Vertical timing (From up to down)

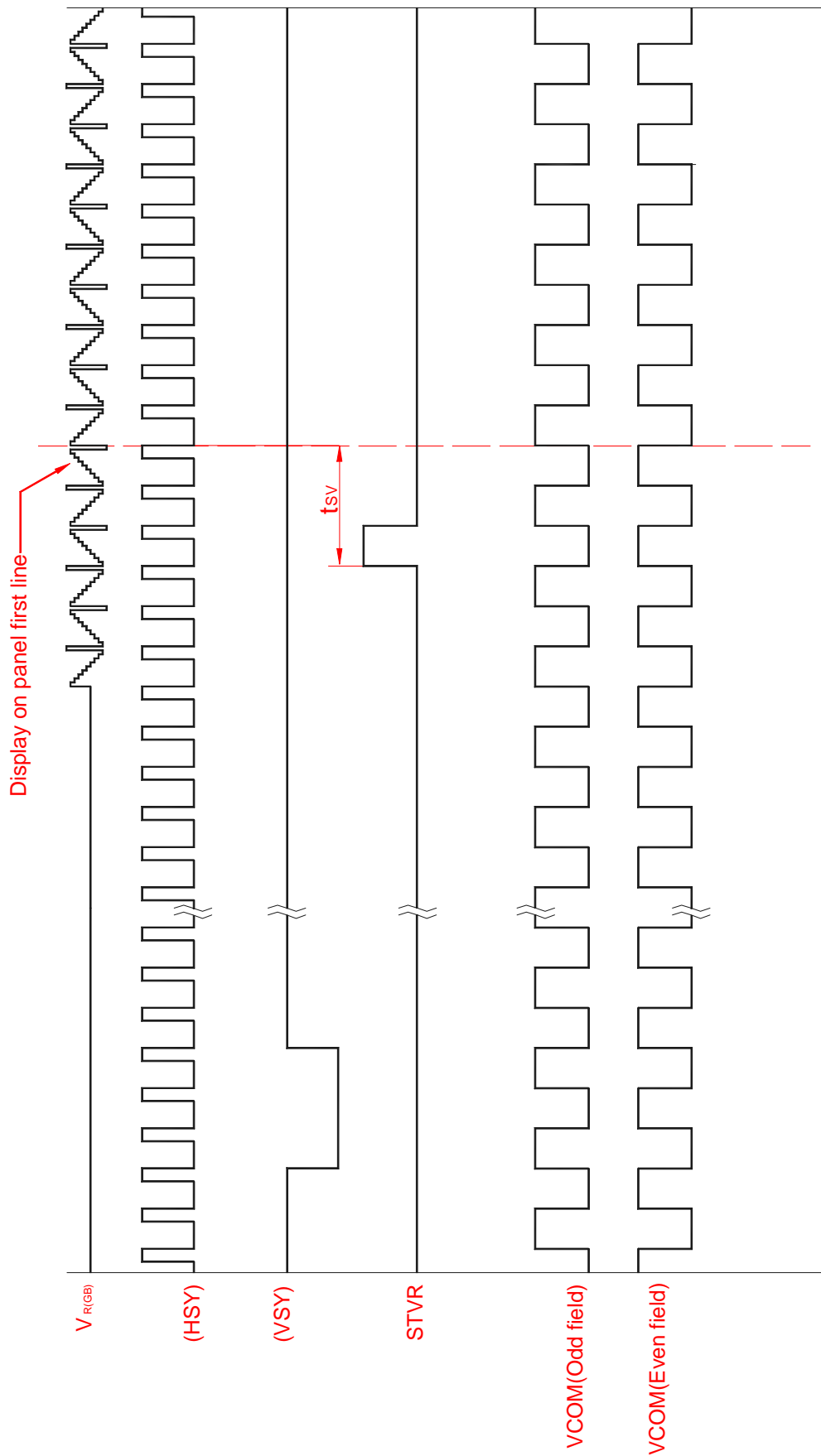

Fig.6-(b) Vertical timing (From down to up)