



UP1855A

PNP SILICON TRANSISTOR

HIGH CURRENT TRANSISTOR

■ **FEATURES**

- * High current switching
- * Low $V_{CE(SAT)}$
- * High h_{FE}

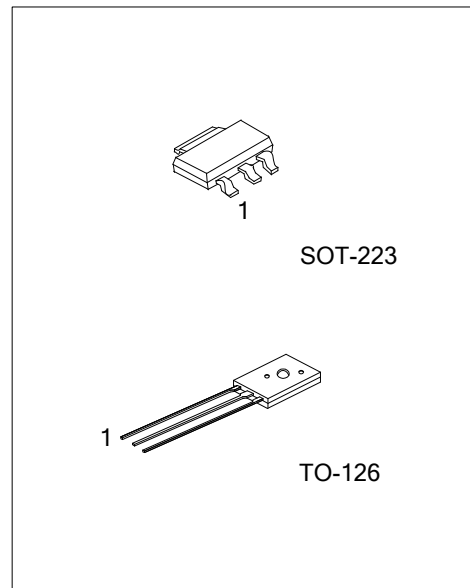

■ **ORDERING INFORMATION**

Ordering Number		Package	Pin Assignment			Packing
Lead Free	Halogen Free		1	2	3	
-	UP1855AG-x-AA3-R	SOT-223	B	C	E	Tape Reel
UP1855AL-x-T60-K	UP1855AG-x-T60-K	TO-126	E	C	B	Bulk

Note: Pin Assignment: E: Emitter B: Base C: Case

<p>UP1855AG-x-AA3-R</p> <p>(1) Packing Type (2) Package Type (3) Rank (4) Green Package</p>	<p>(1) R: Tape Reel, B: Bulk (2) AA3: SOT-223, T60: TO-126 (3) x: refer to Classification of h_{FE3} (4) G: Halogen Free and Lead Free, L: Lead Free</p>
---	---

■ **MARKING**

SOT-223	TO-126
<p>UP1855AG □□□□ → Data Code</p>	<p>UTC □□□□ UP1855A □□□□ → Data Code L: Lead Free G: Halogen Free</p>

■ ABSOLUTE MAXIMUM RATINGS ($T_A=25^\circ\text{C}$, unless otherwise specified)

PARAMETER		SYMBOL	RATINGS	UNIT
Collector -Base Voltage		V_{CB0}	-180	V
Collector -Emitter Voltage		V_{CE0}	-170	V
Emitter -Base Voltage		V_{EBO}	-6	V
Collector Current (Pulse)		I_{CM}	-10	A
Collector Current (DC)		I_C	-4	A
Power Dissipation	SOT-223	P_D	1	W
	TO-126		1	
Junction Temperature		T_J	+150	$^\circ\text{C}$
Storage Temperature		T_{STG}	-40 ~ +150	$^\circ\text{C}$

Note: Absolute maximum ratings are those values beyond which the device could be permanently damaged. Absolute maximum ratings are stress ratings only and functional device operation is not implied.

■ ELECTRICAL CHARACTERISTICS ($T_A=25^\circ\text{C}$, unless otherwise specified)

PARAMETER	SYMBOL	TEST CONDITIONS	MIN	TYP	MAX	UNIT
Collector-Base Breakdown Voltage	BV_{CB0}	$I_C = -100\mu\text{A}$	-180	-210		V
Collector-Emitter Breakdown Voltage	BV_{CE0}	$I_C = -10\text{mA}$	-170			V
Emitter-Base Breakdown Voltage	BV_{EBO}	$I_E = -100\mu\text{A}$	-6	-8		V
Collector Cut-off Current	I_{CBO}	$V_{CB}=-150\text{V}$			-50	nA
		$V_{CB}=-150\text{V}, T_A=100^\circ\text{C}$			-1	μA
Emitter Cut-off Current	I_{EBO}	$V_{EB}=-6\text{V}$			-10	nA
Collector-Emitter Saturation Voltage	$V_{CE(SAT)}$	$I_C=-100\text{mA}, I_B=-5\text{mA}$		-30	-60	mV
		$I_C=-500\text{mA}, I_B=-50\text{mA}$		-70	-120	mV
		$I_C=-1\text{A}, I_B=-100\text{mA}$		-110	-150	mV
		$I_C=-3\text{A}, I_B=-300\text{mA}$		-275	-550	mV
Base-Emitter Saturation Voltage	$V_{BE(SAT)}$	$I_C=-3\text{A}, I_B=-300\text{mA}$		-970	-1110	mV
Base-Emitter Turn-On Voltage	$V_{BE(ON)}$	$I_C=-3\text{A}, V_{CE}=-5\text{V}$		-830	-950	mV
DC Current Gain	h_{FE1}	$I_C=-10\text{mA}, V_{CE}=-5\text{V}$	100	200		
		$I_C=-1\text{A}, V_{CE}=-5\text{V}$	100		300	
		$I_C=-3\text{A}, V_{CE}=-5\text{V}$	28	140		
		$I_C=-10\text{A}, V_{CE}=-5\text{V}$		10		
Transition Frequency	f_T	$I_C=-100\text{mA}, V_{CE}=-10\text{V}, f=50\text{MHz}$		110		MHz
Output Capacitance	C_{ob}	$V_{CB}=-20\text{V}, f=1\text{MHz}$		40		pF
Switching Times	t_{ON}	$I_C=-1\text{A}, V_{CC}=-50\text{V}$		68		ns
	t_{OFF}	$I_{B1}=-100\text{mA}, I_{B2}=100\text{mA}$		1030		ns

Note: Pulse test: $t_P \leq 300\mu\text{s}$, Duty cycle $\leq 2\%$

■ CLASSIFICATION OF h_{FE3}

RANK	A	B
RANGE	28~75	75(MIN.)

TYPICAL CHARACTERISTICS

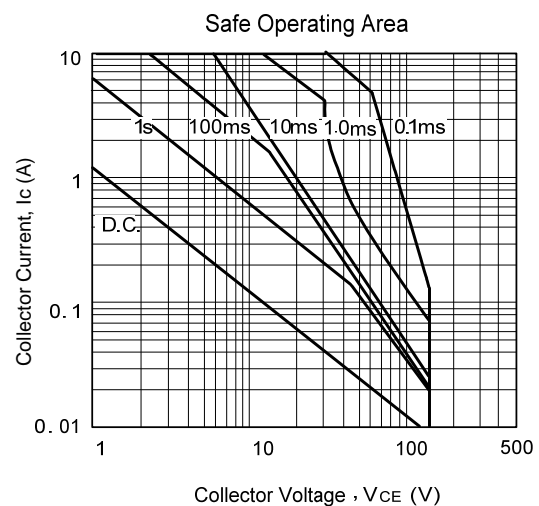
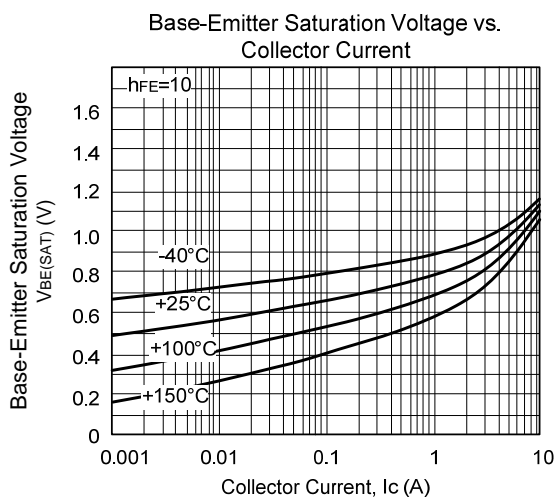
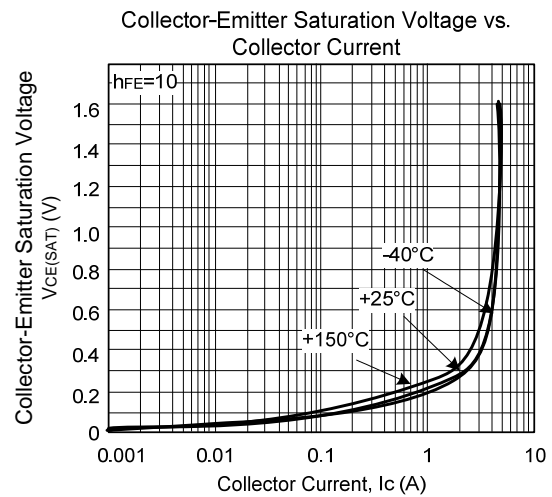
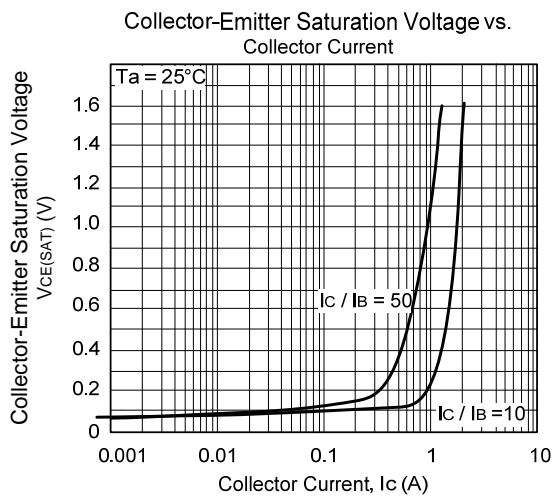
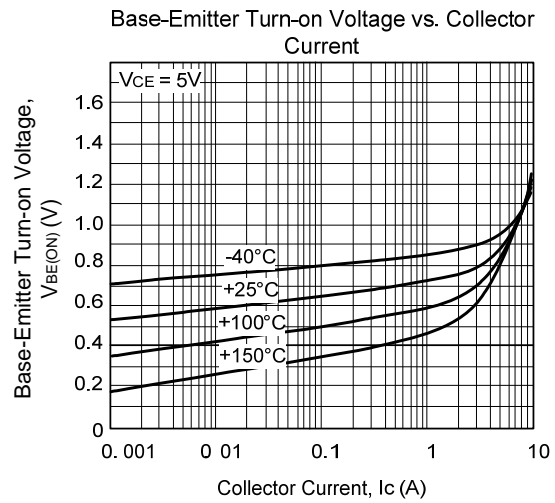
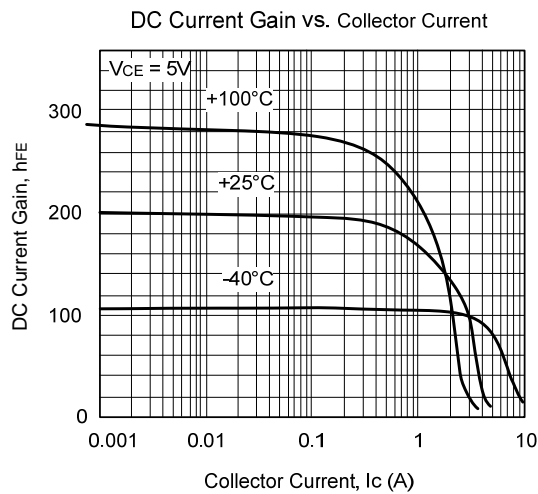

UTC assumes no responsibility for equipment failures that result from using products at values that exceed, even momentarily, rated values (such as maximum ratings, operating condition ranges, or other parameters) listed in products specifications of any and all UTC products described or contained herein. UTC products are not designed for use in life support appliances, devices or systems where malfunction of these products can be reasonably expected to result in personal injury. Reproduction in whole or in part is prohibited without the prior written consent of the copyright owner. The information presented in this document does not form part of any quotation or contract, is believed to be accurate and reliable and may be changed without notice.