

4 PA1572F

**FAST SWITCHING
N-CHANNEL SILICON POWER MOS FET ARRAY**

**PACKAGE DIMENSIONS
in millimeters**

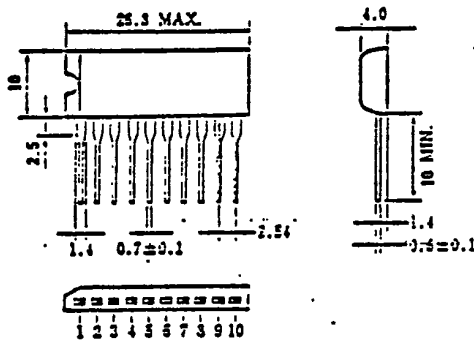

2,4,5,8:Gate
3,5,7,9:Drain
1,10:Source

FEATURES

- Suitable for switching power supplies, actuator controls, and pulse circuits
- Low $R_{DS(on)}$
- No second breakdown

ABSOLUTE MAXIMUM RATINGS (Ta=25°C)

Drain to Source Voltage	V_{DS}	60V
Gate to Source Voltage	V_{GS}	±20V
Continuous Drain Current	$I_D(DC)$	2A
Total Power Dissipation	PT	2.5W
Total Power Dissipation	PT*	22W
Channel Temperature	Tch	150°C
Storage Temperature	Tstg	-55~150°C
		*Tc=25°C

ELECTRICAL CHARACTERISTICS (Ta=25°C)

CHARACTERISTIC	SYMBOL	MIN.	TYP.	MAX.	UNIT	TEST CONDITIONS
Drain Leakage Current	I_{DSS}			10	μA	$V_{DS}=60V, V_{GS}=0$
Gate to Source Leakage Current	I_{GSS}			±100	nA	$V_{GS}=±20V, V_{DS}=0$
Gate to Source Cutoff Voltage	$V_{GS(off)}$	1.0		2.5	V	$V_{DS}=10V, I_D=1mA$
Forward Transfer Admittance	$ y_{fs} $	0.5			S	$V_{DS}=10V, I_D=1A$
Drain to Source On-State Resistance	$R_{DS(on)}$		0.40	0.60	Ω	$V_{GS}=10V, I_D=1A$
			0.60	0.35	Ω	$V_{GS}=4V, I_D=1A$
Input Capacitance	C_{iss}		200		pF	$V_{DS}=10V$
Output Capacitance	C_{oss}		70		pF	$V_{GS}=0$
Reverse Transfer Capacitance	C_{rss}		15		pF	$f=1MHz$
Turn-On Delay Time	$t_d(on)$		45		ns	$I_D=1A, V_{GS}=50V$
Rise Time	t_r		40		ns	$V_{GS(on)}=10V$
Turn-Off Delay Time	$t_d(off)$		450		ns	$R_L=50\Omega$
Fall Time	t_f		110		ns	

TURN-ON AND TURN-OFF TIME TEST CIRCUIT

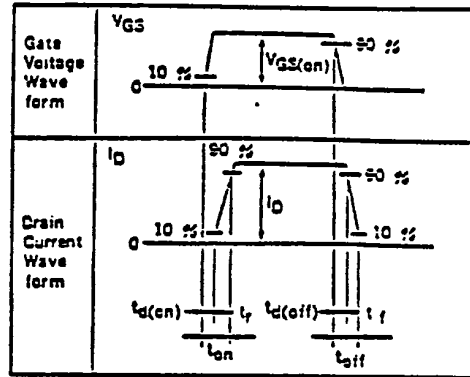
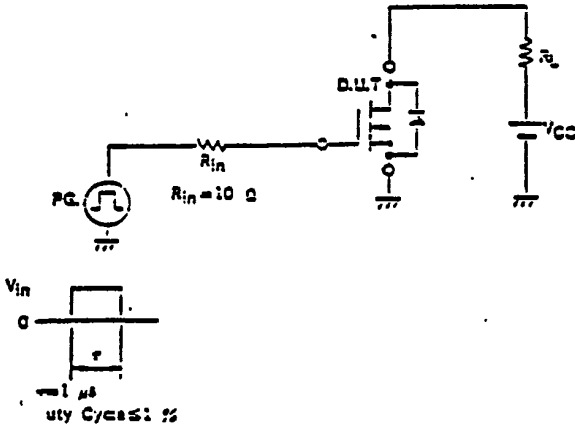

DERATING FACTOR OF FORWARD BIAS SAFE OPERATING AREA

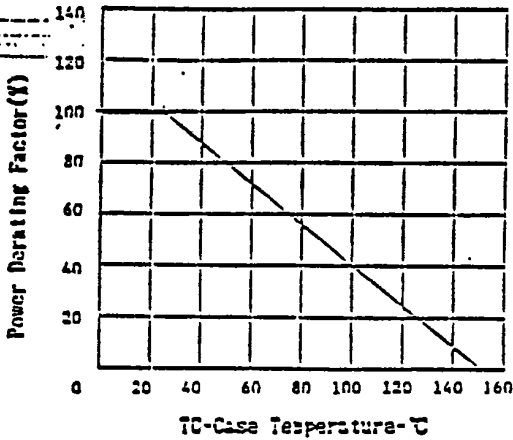

FORWARD BIAS SAFE OPERATING AREA

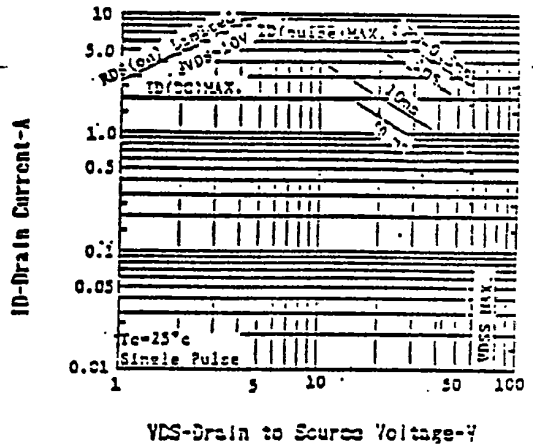

TOTAL POWER DISSIPATION vs. CASE TEMPERATURE

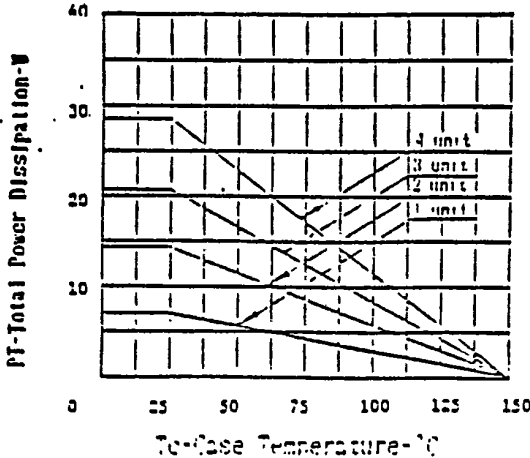

DRAIN CURRENT vs. DRAIN TO SOURCE VOLTAGE

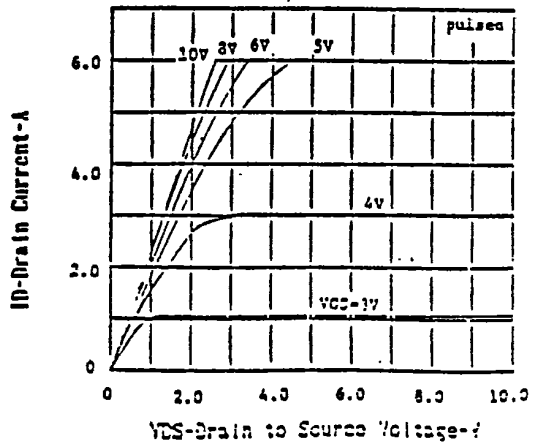

FORWARD TRANSFER ADMITTANCE
VS. DRAIN CURRENT

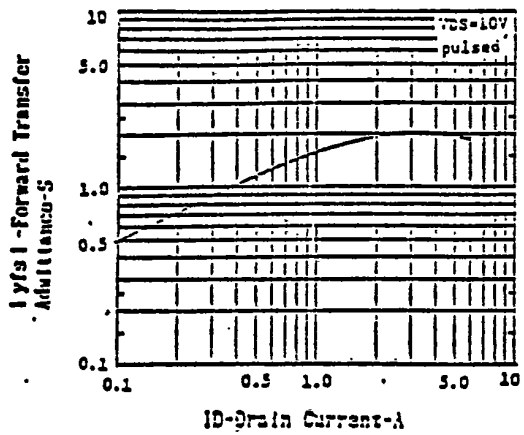

SOURCE TO DRAIN DIODE
FORWARD VOLTAGE

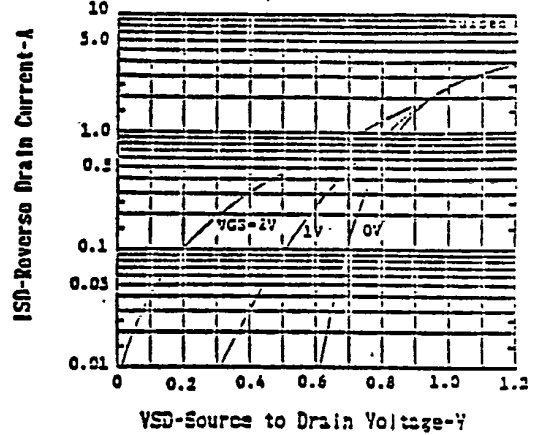

CAPACITANCE VS. DRAIN TO
SOURCE VOLTAGE

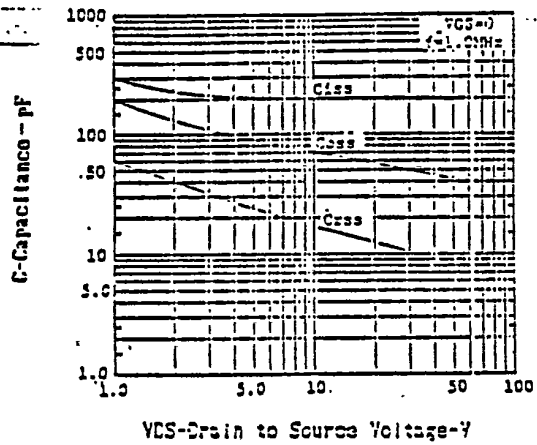

DRAIN TO SOURCE ON-STATE RESISTANCE
VS. GATE TO SOURCE VOLTAGE

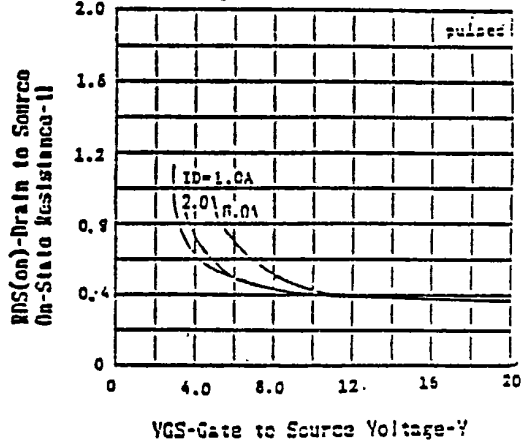

DRAIN TO SOURCE ON-STATE RESISTANCE
VS. CHANNEL TEMPERATURE

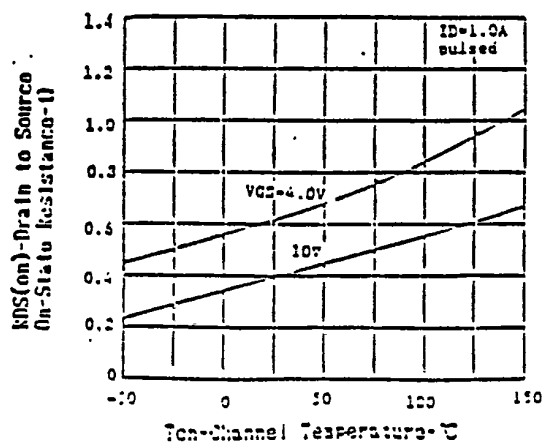

DRAIN TO SOURCE ON-STATE RESISTANCE
VS. DRAIN CURRENT

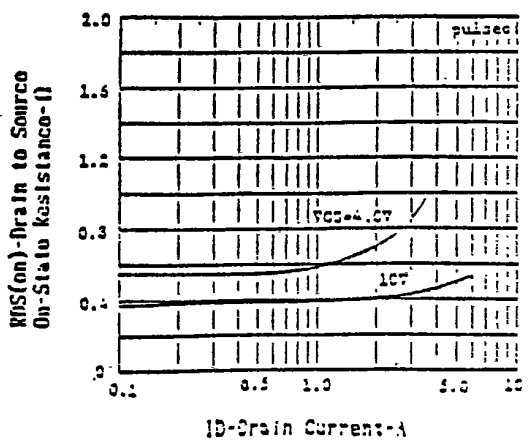

TRANSFER CHARACTERISTICS

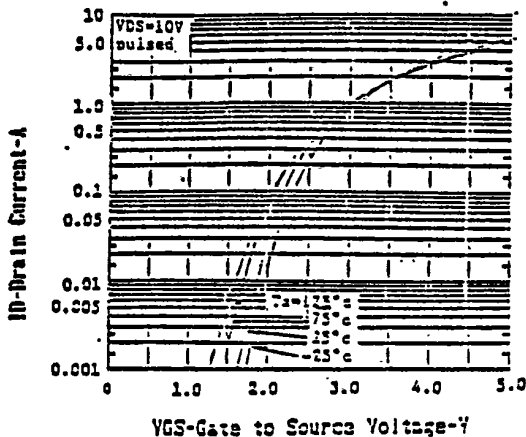

GATE TO SOURCE CUTOFF VOLTAGE VS. CHANNEL TEMPERATURE

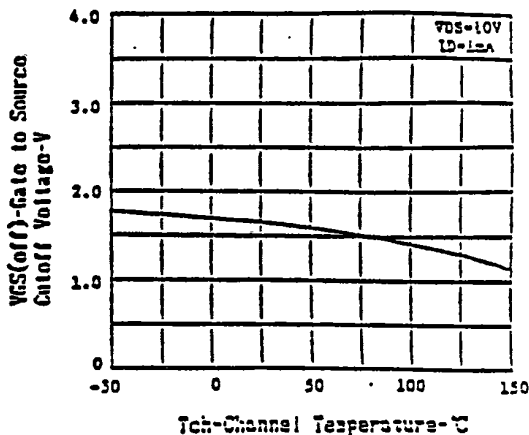

TURN-ON AND TURN-OFF TIME

