

SWITCHING
 N-CHANNEL POWER MOS FET
 INDUSTRIAL USE

DESCRIPTION

This product is N-Channel MOS Field Effect Transistor designed for power management applications and Li-ion battery application.

FEATURES

- 2.5 V gate drive and low on-resistance
 $R_{DS(on)1} = 27 \text{ m}\Omega$ (MAX.) ($V_{GS} = 4.0 \text{ V}$, $I_D = 3.5 \text{ A}$)
 $R_{DS(on)2} = 40 \text{ m}\Omega$ (MAX.) ($V_{GS} = 2.5 \text{ V}$, $I_D = 3.5 \text{ A}$)
- Low C_{iss} : $C_{iss} = 1040 \text{ pF}$ (TYP.)
- Built-in G-S protection diode
- Small and surface mount package (Power SOP8)

PACKAGE DRAWING (Unit : mm)

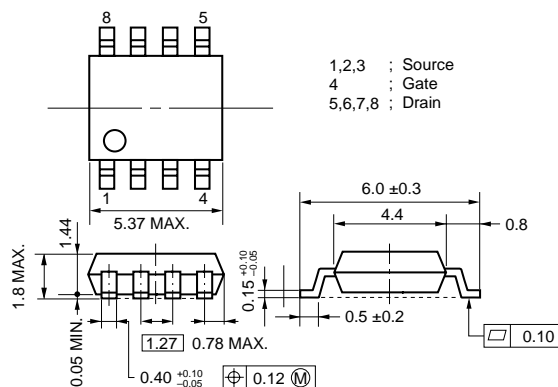

ORDERING INFORMATION

| PART NUMBER | PACKAGE |
|----------------|------------|
| μ PA1701AG | Power SOP8 |

EQUIVALENT CIRCUIT

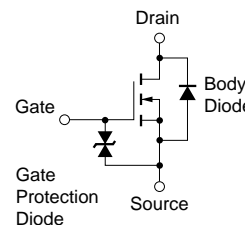

ABSOLUTE MAXIMUM RATINGS ($T_A = 25^\circ\text{C}$, All terminals are connected.)

| | | | |
|---|----------------|--------------|----|
| Drain to Source Voltage ($V_{GS} = 0 \text{ V}$) | V_{DSS} | 30 | V |
| Gate to Source Voltage ($V_{DS} = 0 \text{ V}$) | V_{GSS} | ±12 | V |
| Drain Current (DC) | $I_{D(DC)}$ | ±7.0 | A |
| Drain Current (pulse) ^{Note1} | $I_{D(pulse)}$ | ±28 | A |
| Total Power Dissipation ($T_A = 25^\circ\text{C}$) ^{Note2} | P_T | 2.0 | W |
| Channel Temperature | T_{ch} | 150 | °C |
| Storage Temperature | T_{stg} | -55 to + 150 | °C |

- Notes 1. $PW \leq 10 \mu\text{s}$, Duty Cycle $\leq 1 \%$
 2. Mounted on ceramic substrate of $1200 \text{ mm}^2 \times 1.7 \text{ mm}$

Remark The diode connected between the gate and source of the transistor serves as a protector against ESD. When this device actually used, an additional protection circuit is externally required if a voltage exceeding the rated voltage may be applied to this device.

The information in this document is subject to change without notice.

ELECTRICAL CHARACTERISTICS (T_A = 25 °C)

| CHARACTERISTICS | SYMBOL | TEST CONDITIONS | MIN. | TYP. | MAX. | UNIT |
|-------------------------------------|----------------------|---|------|------|------|------|
| Drain to Source On-state Resistance | R _{DS(on)1} | V _{GS} = 4.0 V, I _D = 3.5 A | | 19 | 27 | mΩ |
| | R _{DS(on)2} | V _{GS} = 2.5 V, I _D = 3.5 A | | 25 | 40 | mΩ |
| Gate to Source Cut-off Voltage | V _{GS(off)} | V _{DS} = 10 V, I _D = 1 mA | 0.5 | 0.9 | 1.5 | V |
| Forward Transfer Admittance | y _{fs} | V _{DS} = 10 V, I _D = 3.5 A | 6.0 | 13 | | S |
| Drain Leakage Current | I _{DSS} | V _{DS} = 30 V, V _{GS} = 0 V | | | 10 | μA |
| Gate to Source Leakage Current | I _{GSS} | V _{GS} = ±12 V, V _{DS} = 0 V | | | ±10 | μA |
| Input Capacitance | C _{iss} | V _{DS} = 10 V | | 1040 | | pF |
| Output Capacitance | C _{oss} | V _{GS} = 0 V | | 340 | | pF |
| Reverse Transfer Capacitance | C _{rss} | f = 1 MHz | | 150 | | pF |
| Turn-on Delay Time | t _{d(on)} | I _D = 3.5 A | | 25 | | ns |
| Rise Time | t _r | V _{GS(on)} = 4.0 V | | 120 | | ns |
| Turn-off Delay Time | t _{d(off)} | V _{DD} = 15 V | | 73 | | ns |
| Fall Time | t _f | R _G = 10 Ω | | 77 | | ns |
| Total Gate Charge | Q _G | I _D = 7.0 A | | 13.2 | | nC |
| Gate to Source Charge | Q _{GS} | V _{DD} = 24 V | | 1.8 | | nC |
| Gate to Drain Charge | Q _{GD} | V _{GS} = 4.0 V | | 5.8 | | nC |
| Body Diode Forward Voltage | V _{F(S-D)} | I _F = 7.0 A, V _{GS} = 0 V | | 0.77 | | V |
| Reverse Recovery Time | t _{rr} | I _F = 7.0 A, V _{GS} = 0 V | | 31 | | ns |
| Reverse Recovery Charge | Q _{rr} | di/dt = 100 A/μs | | 58 | | nC |

TEST CIRCUIT 1 SWITCHING TIME

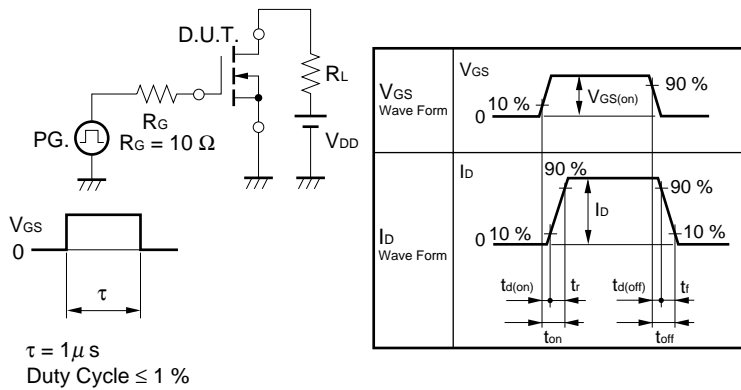

TEST CIRCUIT 2 GATE CHARGE

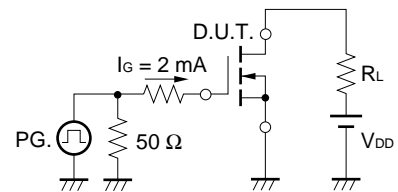

TYPICAL CHARACTERISTICS ($T_A = 25^\circ\text{C}$)

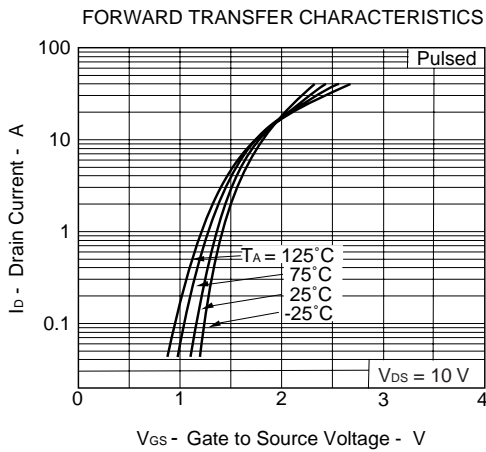
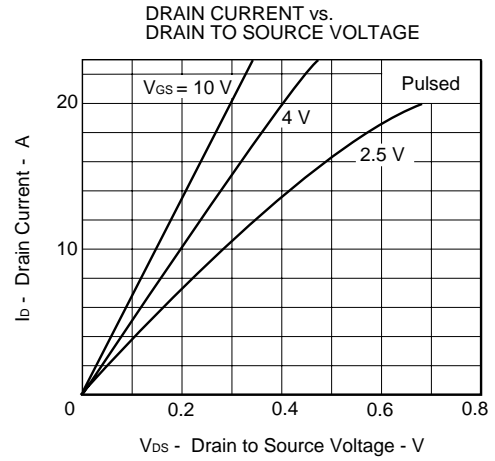
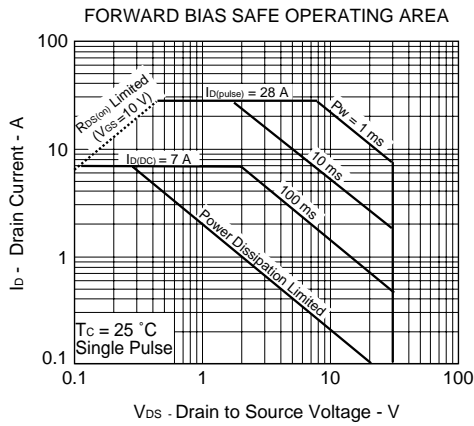
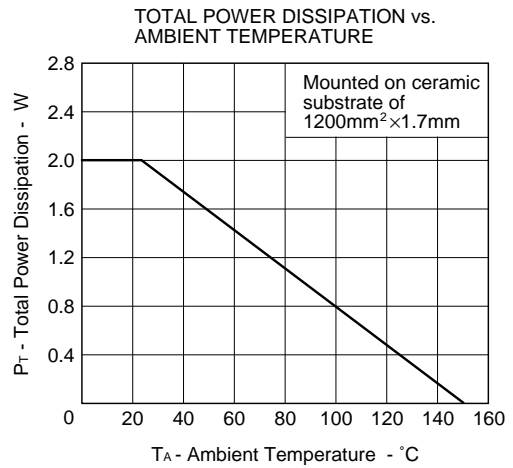
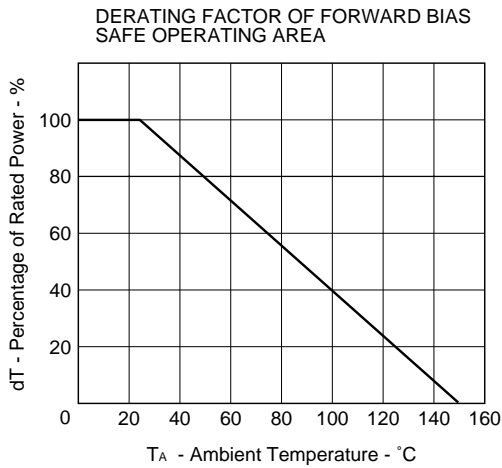

TRANSIENT THERMAL RESISTANCE vs. PULSE WIDTH

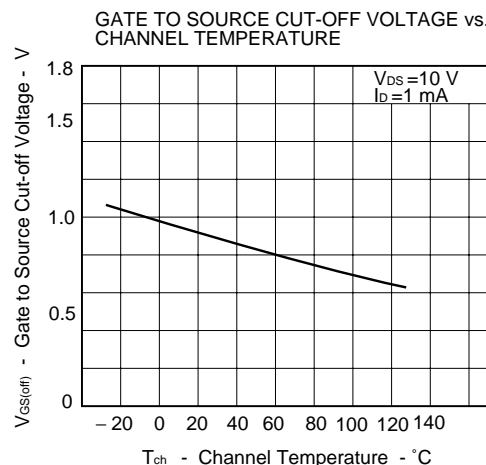
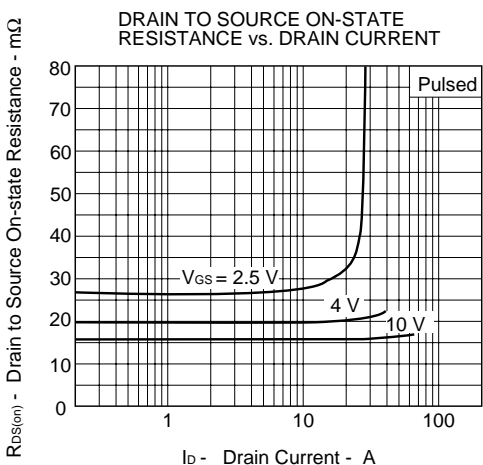
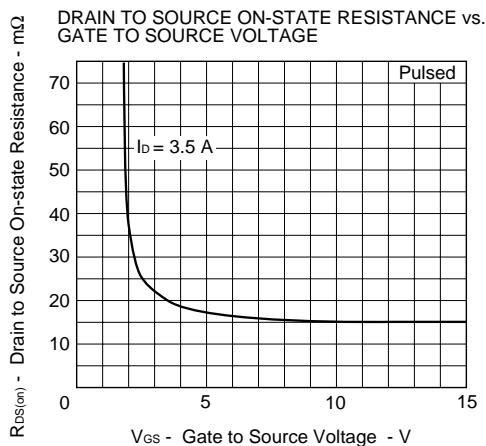
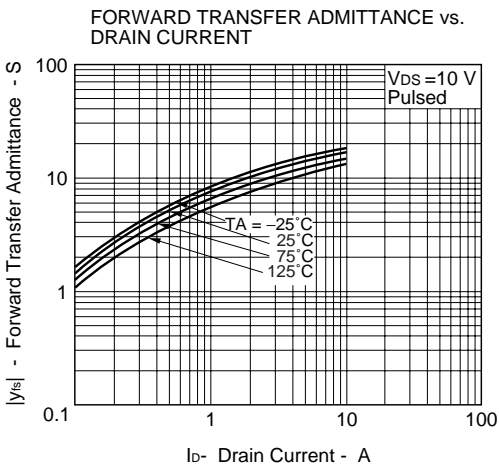
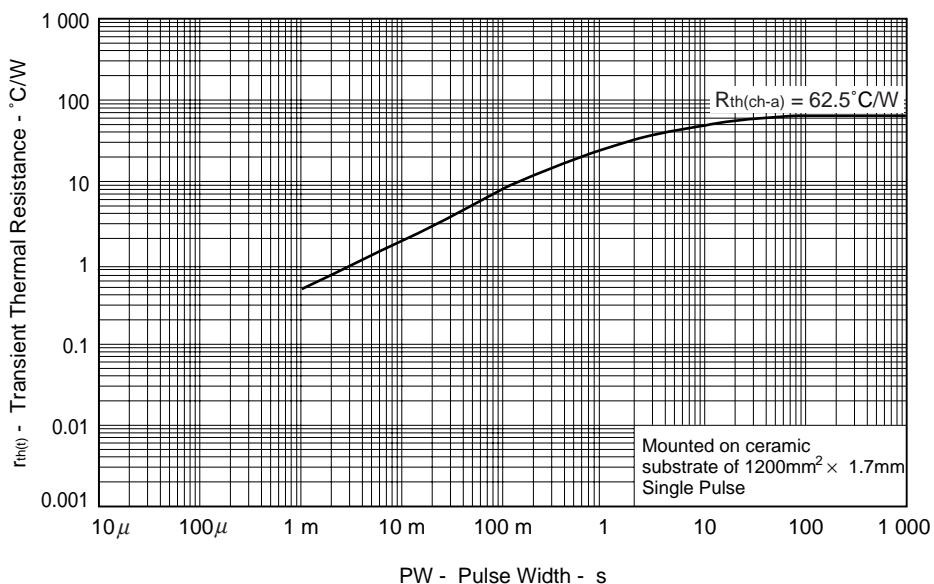

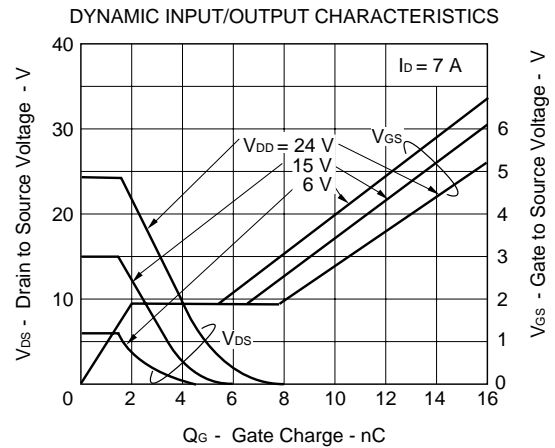
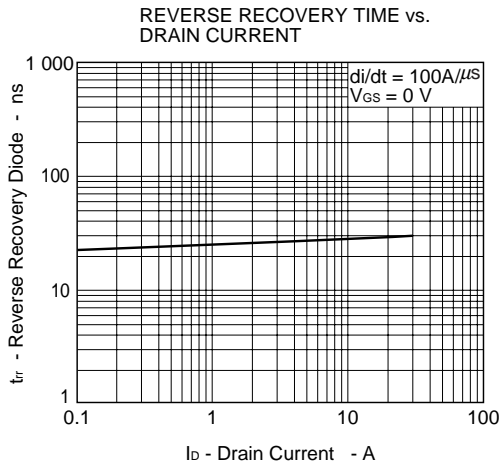
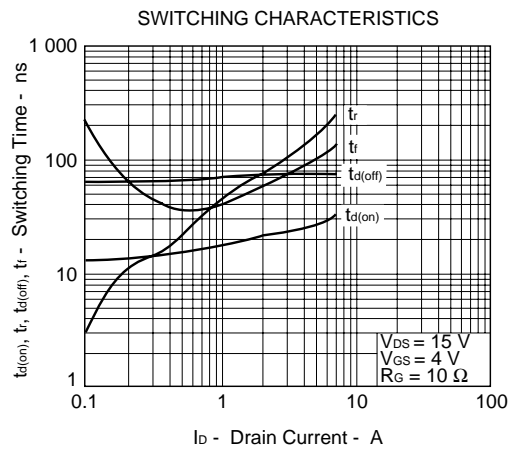
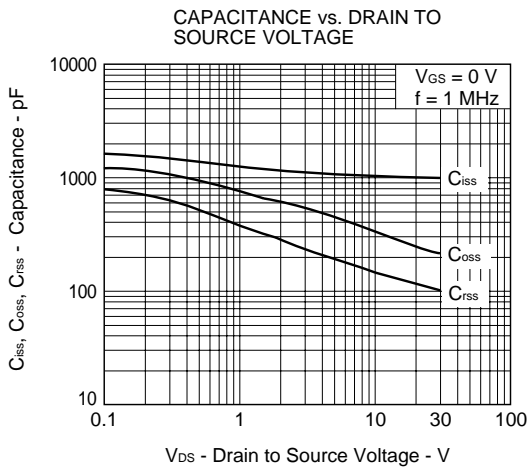
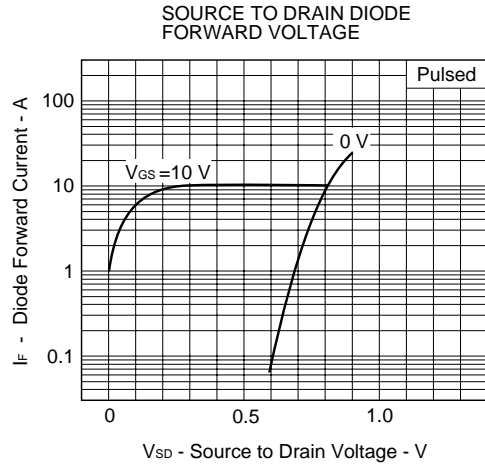
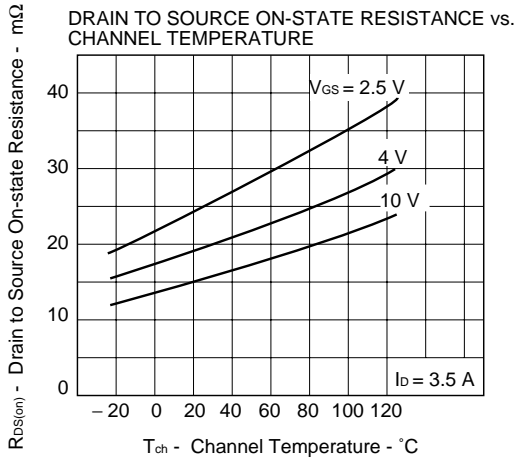

[MEMO]

[MEMO]

No part of this document may be copied or reproduced in any form or by any means without the prior written consent of NEC Corporation. NEC Corporation assumes no responsibility for any errors which may appear in this document.

NEC Corporation does not assume any liability for infringement of patents, copyrights or other intellectual property rights of third parties by or arising from use of a device described herein or any other liability arising from use of such device. No license, either express, implied or otherwise, is granted under any patents, copyrights or other intellectual property rights of NEC Corporation or others.

While NEC Corporation has been making continuous effort to enhance the reliability of its semiconductor devices, the possibility of defects cannot be eliminated entirely. To minimize risks of damage or injury to persons or property arising from a defect in an NEC semiconductor device, customers must incorporate sufficient safety measures in its design, such as redundancy, fire-containment, and anti-failure features.

NEC devices are classified into the following three quality grades:

"Standard", "Special", and "Specific". The Specific quality grade applies only to devices developed based on a customer designated "quality assurance program" for a specific application. The recommended applications of a device depend on its quality grade, as indicated below. Customers must check the quality grade of each device before using it in a particular application.

Standard: Computers, office equipment, communications equipment, test and measurement equipment, audio and visual equipment, home electronic appliances, machine tools, personal electronic equipment and industrial robots

Special: Transportation equipment (automobiles, trains, ships, etc.), traffic control systems, anti-disaster systems, anti-crime systems, safety equipment and medical equipment (not specifically designed for life support)

Specific: Aircrafts, aerospace equipment, submersible repeaters, nuclear reactor control systems, life support systems or medical equipment for life support, etc.

The quality grade of NEC devices is "Standard" unless otherwise specified in NEC's Data Sheets or Data Books. If customers intend to use NEC devices for applications other than those specified for Standard quality grade, they should contact an NEC sales representative in advance.

Anti-radioactive design is not implemented in this product.