

# MOS FIELD EFFECT TRANSISTOR

# $\mu$ PA2450B

## N-CHANNEL MOS FIELD EFFECT TRANSISTOR FOR SWITCHING

### DESCRIPTION

The  $\mu$  PA2450B is a switching device, which can be driven directly by a 2.5 V power source.

The  $\mu$  PA2450B features a low on-state resistance and excellent switching characteristics, and is suitable for applications such as power switch of portable machine and so on.

### FEATURES

- 2.5 V drive available
- Low on-state resistance
  - $R_{DS(on)1} = 17.5 \text{ m}\Omega \text{ MAX. (} V_{GS} = 4.5 \text{ V, } I_D = 4.0 \text{ A)}$
  - $R_{DS(on)2} = 18.5 \text{ m}\Omega \text{ MAX. (} V_{GS} = 4.0 \text{ V, } I_D = 4.0 \text{ A)}$
  - $R_{DS(on)3} = 22.0 \text{ m}\Omega \text{ MAX. (} V_{GS} = 3.1 \text{ V, } I_D = 4.0 \text{ A)}$
  - $R_{DS(on)4} = 27.5 \text{ m}\Omega \text{ MAX. (} V_{GS} = 2.5 \text{ V, } I_D = 4.0 \text{ A)}$
- Built-in G-S protection diode against ESD

### ORDERING INFORMATION

PART NUMBER	PACKAGE
$\mu$ PA2450BTL	6PIN HWSON (4521)

### ABSOLUTE MAXIMUM RATINGS ( $T_A = 25^\circ\text{C}$ )

Drain to Source Voltage ( $V_{GS} = 0 \text{ V}$ )	$V_{DSS}$	20.0	V
Gate to Source Voltage ( $V_{DS} = 0 \text{ V}$ )	$V_{GSS}$	$\pm 12.0$	V
Drain Current (DC) <sup>Note1</sup>	$I_{D(DC)}$	$\pm 8.6$	A
Drain Current (pulse) <sup>Note2</sup>	$I_{D(pulse)}$	$\pm 80.0$	A
Total Power Dissipation (2 units) <sup>Note1</sup>	$P_{T1}$	2.5	W
Total Power Dissipation (2 units) <sup>Note3</sup>	$P_{T2}$	0.7	W
Channel Temperature	$T_{ch}$	150	$^\circ\text{C}$
Storage Temperature	$T_{stg}$	-55 to +150	$^\circ\text{C}$

- Notes**
1. Mounted on ceramic board of  $50 \text{ cm}^2 \times 1.1 \text{ mm}$
  2.  $PW \leq 10 \mu\text{s}$ , Duty Cycle  $\leq 1\%$
  3. Mounted on FR-4 board of  $50 \text{ cm}^2 \times 1.1 \text{ mm}$

**Remark** The diode connected between the gate and source of the transistor serves as a protector against ESD. When this device actually used, an additional protection circuit is externally required if a voltage exceeding the rated voltage may be applied to this device.

### PACKAGE DRAWING (Unit: mm)

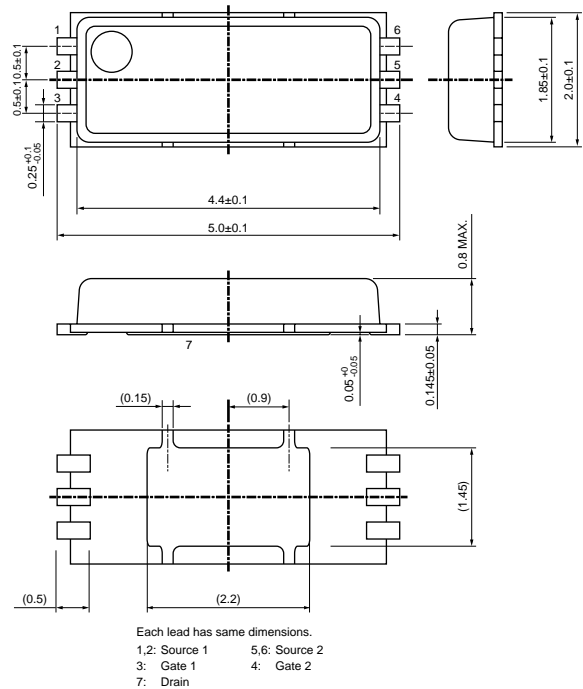

### EQUIVALENT CIRCUIT

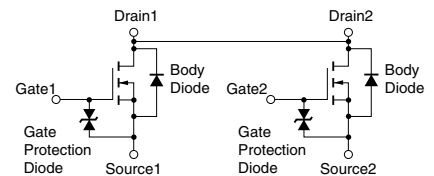

The information in this document is subject to change without notice. Before using this document, please confirm that this is the latest version.

Not all products and/or types are available in every country. Please check with an NEC Electronics sales representative for availability and additional information.

**ELECTRICAL CHARACTERISTICS (T<sub>A</sub> = 25°C)**

CHARACTERISTICS	SYMBOL	TEST CONDITIONS	MIN.	TYP.	MAX.	UNIT
Zero Gate Voltage Drain Current	I <sub>DSS</sub>	V <sub>DS</sub> = 20.0 V, V <sub>GS</sub> = 0 V			1.0	μA
Gate Leakage Current	I <sub>GSS</sub>	V <sub>GS</sub> = ±12.0 V, V <sub>DS</sub> = 0 V			±10.0	μA
Gate Cut-off Voltage	V <sub>GS(off)</sub>	V <sub>DS</sub> = 10.0 V, I <sub>D</sub> = 1.0 mA	0.50		1.50	V
Forward Transfer Admittance <sup>Note</sup>	y <sub>fs</sub>	V <sub>DS</sub> = 10.0 V, I <sub>D</sub> = 4.0 A	3.5			S
Drain to Source On-state Resistance <sup>Note</sup>	R <sub>DS(on)1</sub>	V <sub>GS</sub> = 4.5 V, I <sub>D</sub> = 4.0 A	11.0	12.5	17.5	mΩ
	R <sub>DS(on)2</sub>	V <sub>GS</sub> = 4.0 V, I <sub>D</sub> = 4.0 A	11.5	13.0	18.5	mΩ
	R <sub>DS(on)3</sub>	V <sub>GS</sub> = 3.1 V, I <sub>D</sub> = 4.0 A	12.0	14.5	22.0	mΩ
	R <sub>DS(on)4</sub>	V <sub>GS</sub> = 2.5 V, I <sub>D</sub> = 4.0 A	15.3	18.0	27.5	mΩ
Input Capacitance	C <sub>iss</sub>	V <sub>DS</sub> = 10.0 V		520		pF
Output Capacitance	C <sub>oss</sub>	V <sub>GS</sub> = 0 V		133		pF
Reverse Transfer Capacitance	C <sub>rss</sub>	f = 1.0 MHz		92		pF
Turn-on Delay Time	t <sub>d(on)</sub>	V <sub>DD</sub> = 10.0 V		21		ns
Rise Time	t <sub>r</sub>	I <sub>D</sub> = 4.0 A		86		ns
Turn-off Delay Time	t <sub>d(off)</sub>	V <sub>GS</sub> = 4.0 V		124		ns
Fall Time	t <sub>f</sub>	R <sub>G</sub> = 6 Ω		107		ns
Total Gate Charge	Q <sub>G</sub>	V <sub>DD</sub> = 16.0 V		8.0		nC
Gate to Source Charge	Q <sub>GS</sub>	V <sub>GS</sub> = 4.0 V		1.3		nC
Gate to Drain Charge	Q <sub>GD</sub>	I <sub>D</sub> = 8.6 A		3.3		nC
Body Diode Forward Voltage <sup>Note</sup>	V <sub>F(S-D)</sub>	I <sub>F</sub> = 8.6 A, V <sub>GS</sub> = 0 V		0.83		V
Reverse Recovery Time	t <sub>rr</sub>	I <sub>F</sub> = 8.6 A, V <sub>GS</sub> = 0 V		128		ns
Reverse Recovery Charge	Q <sub>rr</sub>	di/dt = 100 A/μs		129		nC

**Note** Pulsed: PW ≤ 350 μs, Duty Cycle ≤ 2%

**TEST CIRCUIT 1 SWITCHING TIME**

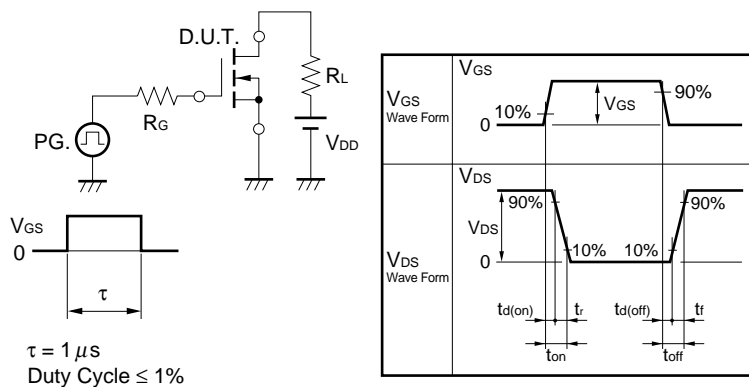

**TEST CIRCUIT 2 GATE CHARGE**

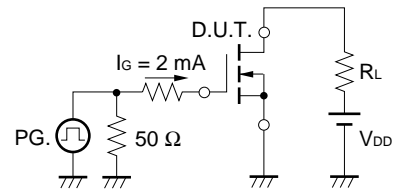

ELECTRICAL CHARACTERISTICS (T<sub>A</sub> = 25°C)

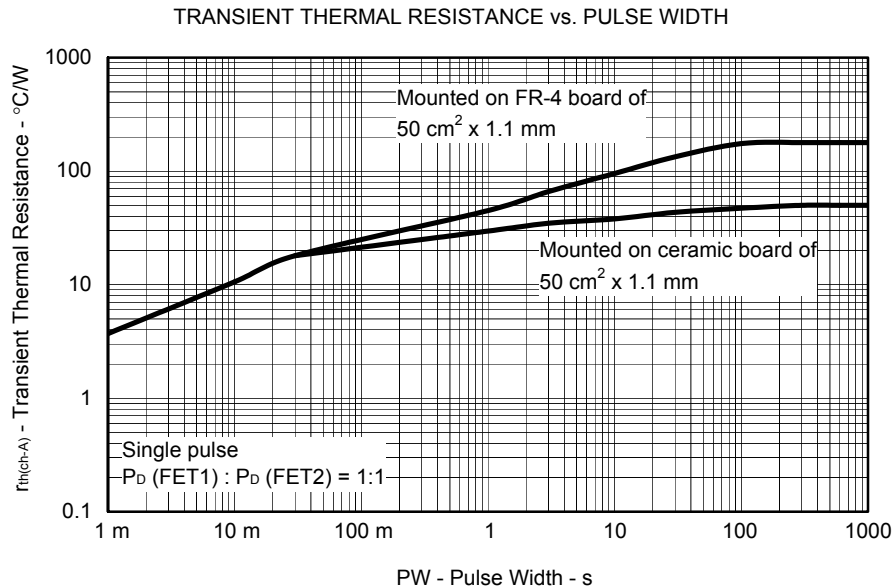
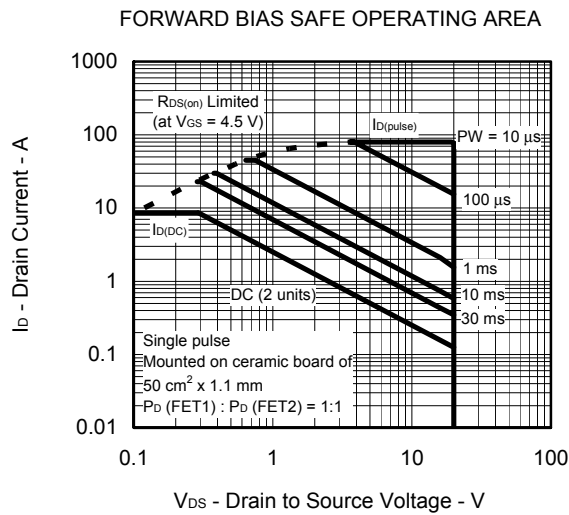
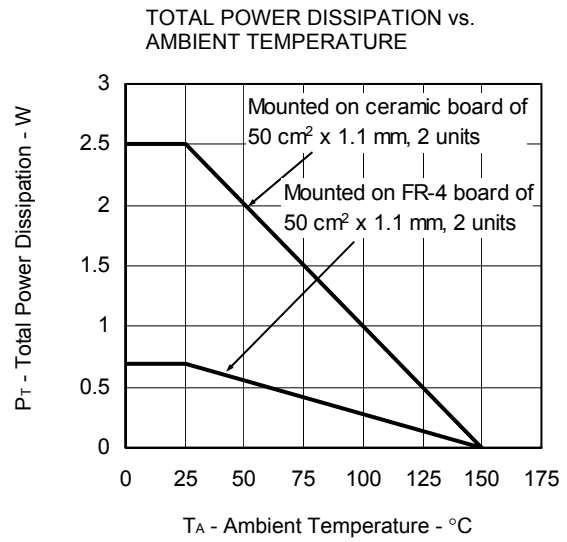
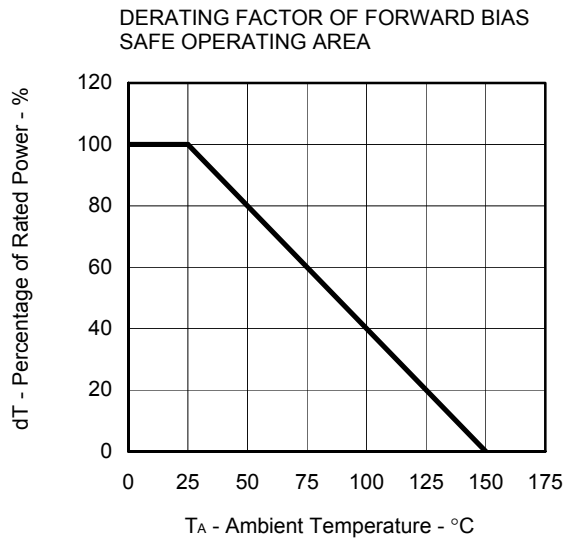

DRAIN CURRENT vs. DRAIN TO SOURCE VOLTAGE

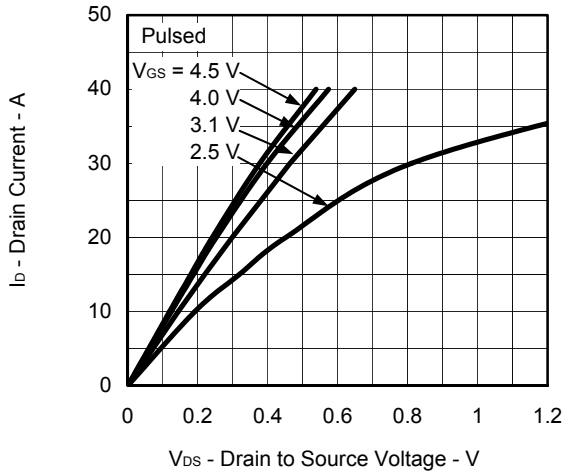

FORWARD TRANSFER CHARACTERISTICS

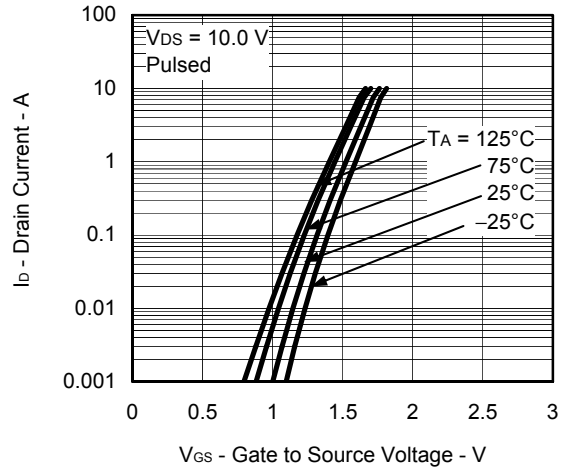

GATE CUT-OFF VOLTAGE vs. CHANNEL TEMPERATURE

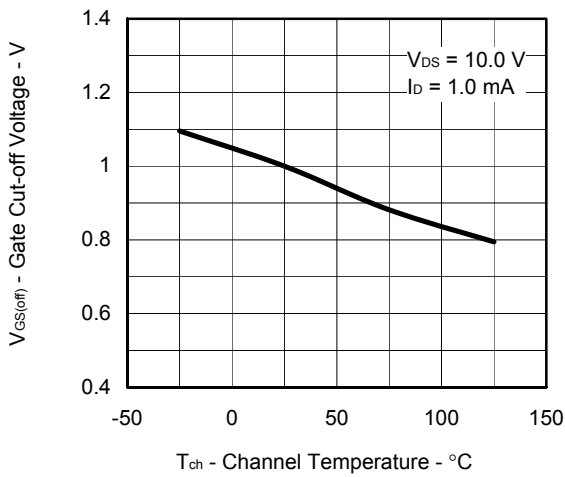

FORWARD TRANSFER ADMITTANCE vs. DRAIN CURRENT

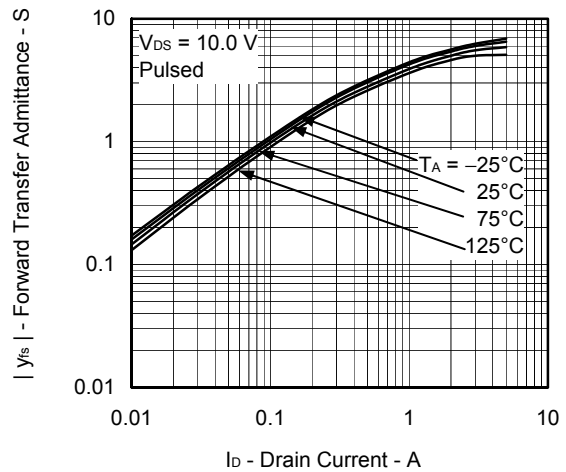

DRAIN TO SOURCE ON-STATE RESISTANCE vs. DRAIN CURRENT

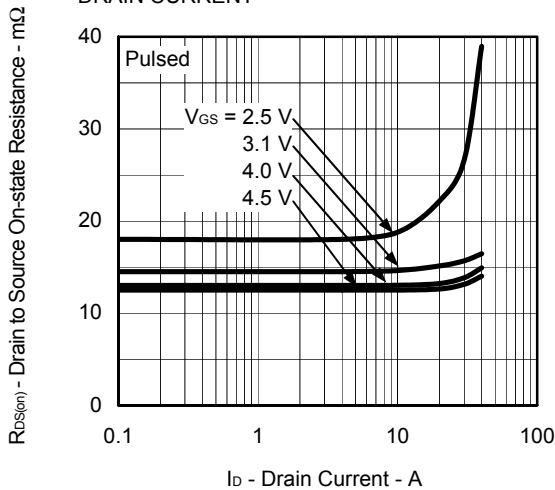

DRAIN TO SOURCE ON-STATE RESISTANCE vs. GATE TO SOURCE VOLTAGE

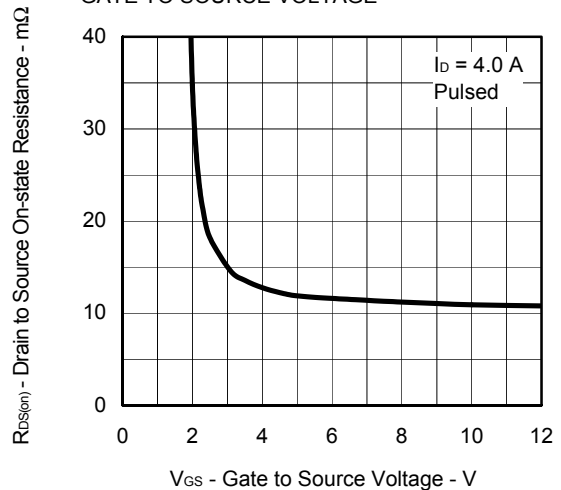

DRAIN TO SOURCE ON-STATE RESISTANCE vs. CHANNEL TEMPERATURE

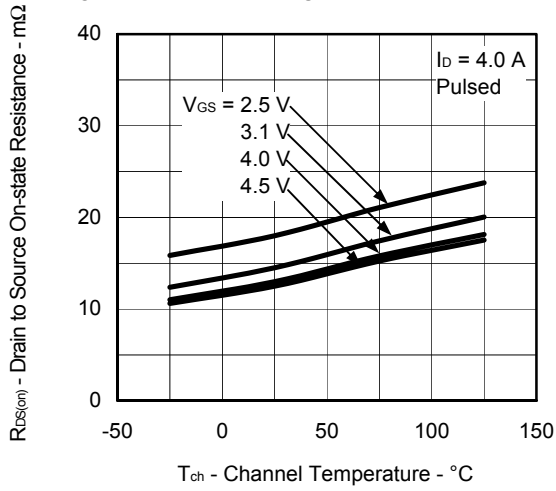

CAPACITANCE vs. DRAIN TO SOURCE VOLTAGE

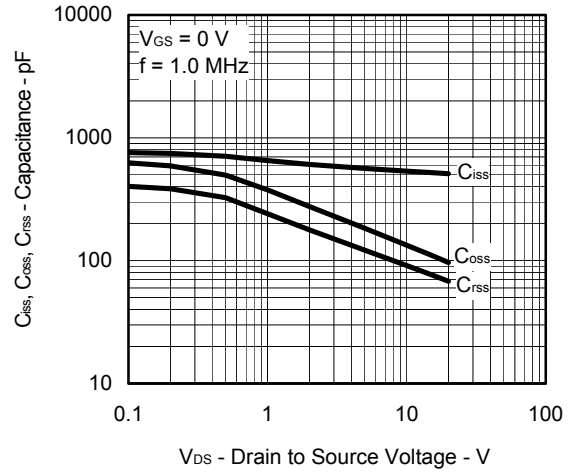

SWITCHING CHARACTERISTICS

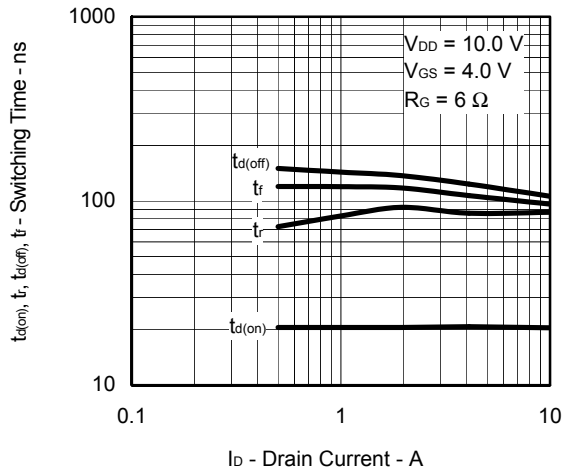

DYNAMIC INPUT CHARACTERISTICS

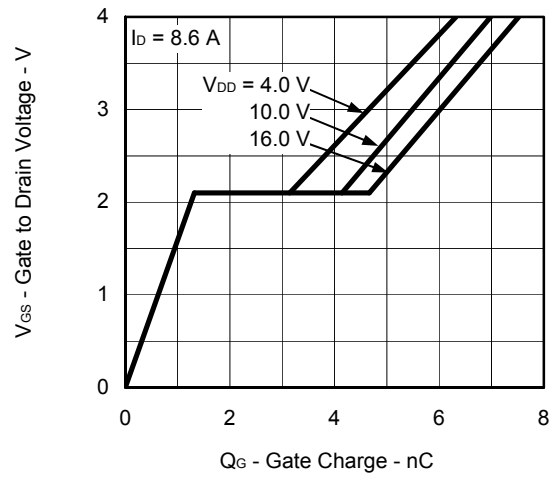

SOURCE TO DRAIN DIODE FORWARD VOLTAGE

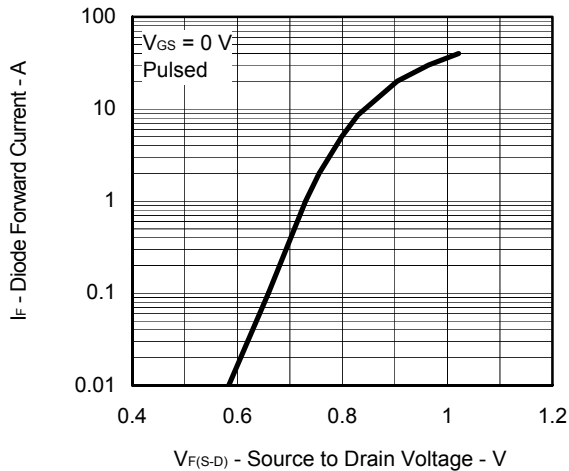

**<Notes for using this device safely>**

When you use this device, in order to prevent a customer's hazard and damage, use it with understanding the following contents. If used exceeding recommended conditions, there is a possibility of causing failure of the device and characteristic degradation.

1. When you mount the device on a substrate, carry out within our recommended soldering conditions of infrared reflow. If mounted exceeding the conditions, the characteristic of a device may be degraded and it may result in failure.
2. When you wash the device mounted the substrate, carry out within our recommended conditions. If washed exceeding the conditions, the characteristic of a device may be degraded and it may result in failure.
3. When you use ultrasonic wave to substrate after the device mounting, prevent from touching a resonance generator directly. If it touches, the characteristic of a device may be degraded and it may result in failure.
4. Please refer to **Figure 1** as an example of the land pattern. Optimize the land pattern in consideration of density, appearance of solder fillets, common difference, etc in an actual design.

**Figure 1. Example of the land pattern**

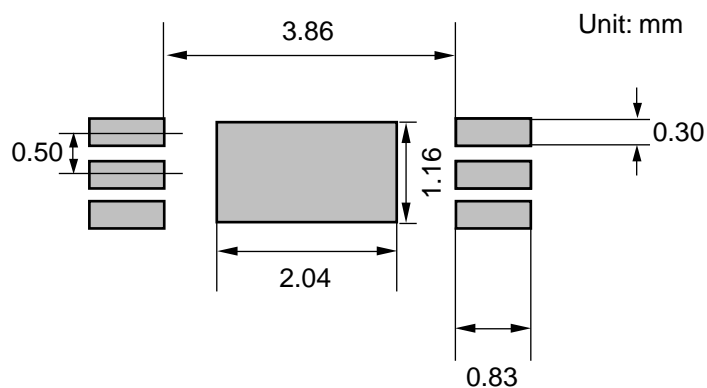

5. This device is very thin device and should be handled with caution for mechanical stress. The rate of distortion applied to the device should become below 2000  $\mu\epsilon$ .<sup>Note1</sup> If the rate of distortion exceeds 2000  $\mu\epsilon$ , the characteristic of a device may be degraded and it may result in failure.

**Figure 2. Direction of substrate and stress**

The substrate that mounted the device is on a stand with a support width of 24 mm.  
The device is turned downward. The stress is applied from a top.

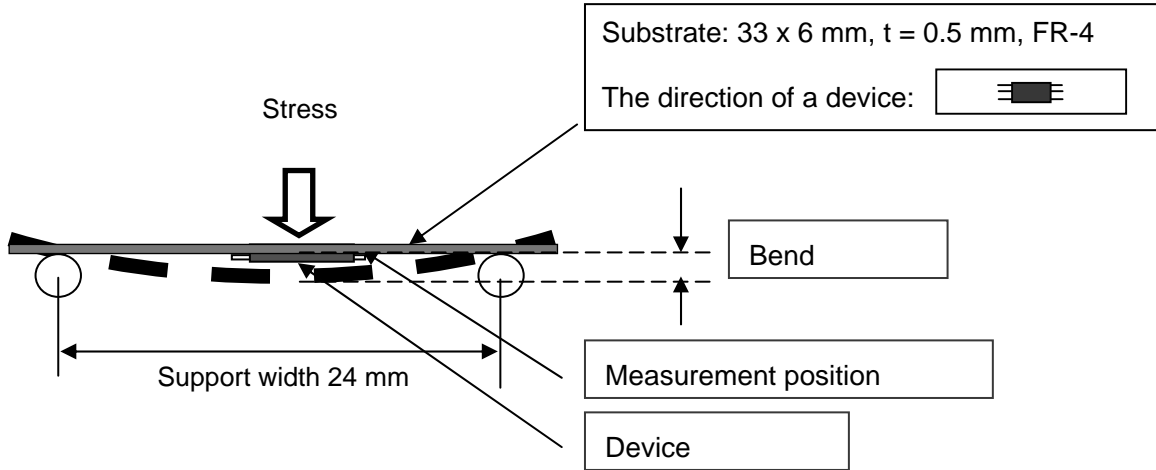

**Figure 3. Example of the bend and the rate of distortion**<sup>Note2</sup>

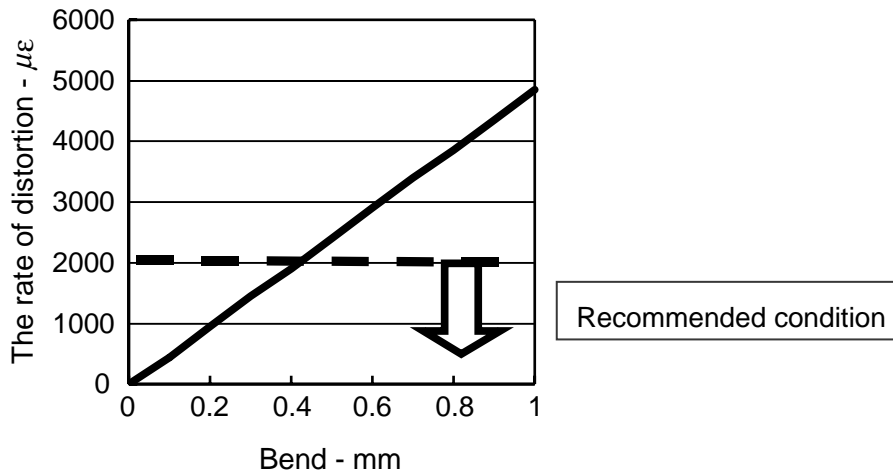

**Note 1.** Definition of rate of distortion(written as  $\epsilon$  in this document)

$$\epsilon = (l - l_0)/l_0$$

$l_0$ : Distance for two arbitrary points before receiving stress.

$l$ : Distance above-mentioned when receiving stress.

**2.** The relation of the distortion and the bend changes with several conditions, such as a size of substrate and so on.

- **The information in this document is current as of January, 2004. The information is subject to change without notice. For actual design-in, refer to the latest publications of NEC Electronics data sheets or data books, etc., for the most up-to-date specifications of NEC Electronics products. Not all products and/or types are available in every country. Please check with an NEC Electronics sales representative for availability and additional information.**
- No part of this document may be copied or reproduced in any form or by any means without the prior written consent of NEC Electronics. NEC Electronics assumes no responsibility for any errors that may appear in this document.
- NEC Electronics does not assume any liability for infringement of patents, copyrights or other intellectual property rights of third parties by or arising from the use of NEC Electronics products listed in this document or any other liability arising from the use of such products. No license, express, implied or otherwise, is granted under any patents, copyrights or other intellectual property rights of NEC Electronics or others.
- Descriptions of circuits, software and other related information in this document are provided for illustrative purposes in semiconductor product operation and application examples. The incorporation of these circuits, software and information in the design of a customer's equipment shall be done under the full responsibility of the customer. NEC Electronics assumes no responsibility for any losses incurred by customers or third parties arising from the use of these circuits, software and information.
- While NEC Electronics endeavors to enhance the quality, reliability and safety of NEC Electronics products, customers agree and acknowledge that the possibility of defects thereof cannot be eliminated entirely. To minimize risks of damage to property or injury (including death) to persons arising from defects in NEC Electronics products, customers must incorporate sufficient safety measures in their design, such as redundancy, fire-containment and anti-failure features.
- NEC Electronics products are classified into the following three quality grades: "Standard", "Special" and "Specific".

The "Specific" quality grade applies only to NEC Electronics products developed based on a customer-designated "quality assurance program" for a specific application. The recommended applications of an NEC Electronics product depend on its quality grade, as indicated below. Customers must check the quality grade of each NEC Electronics product before using it in a particular application.

"Standard": Computers, office equipment, communications equipment, test and measurement equipment, audio and visual equipment, home electronic appliances, machine tools, personal electronic equipment and industrial robots.

"Special": Transportation equipment (automobiles, trains, ships, etc.), traffic control systems, anti-disaster systems, anti-crime systems, safety equipment and medical equipment (not specifically designed for life support).

"Specific": Aircraft, aerospace equipment, submersible repeaters, nuclear reactor control systems, life support systems and medical equipment for life support, etc.

The quality grade of NEC Electronics products is "Standard" unless otherwise expressly specified in NEC Electronics data sheets or data books, etc. If customers wish to use NEC Electronics products in applications not intended by NEC Electronics, they must contact an NEC Electronics sales representative in advance to determine NEC Electronics' willingness to support a given application.

(Note)

- (1) "NEC Electronics" as used in this statement means NEC Electronics Corporation and also includes its majority-owned subsidiaries.
- (2) "NEC Electronics products" means any product developed or manufactured by or for NEC Electronics (as defined above).