

N-CHANNEL MOS FET (6-PIN 2 CIRCUITS)

The μ PA602T is a mini-mold device provided with two MOS FET circuits. It achieves high-density mounting and saves mounting costs.

FEATURES

- Two MOS FET circuits in package the same size as SC-59
- Complement to μ PA603T
- Automatic mounting supported

PACKAGE DIMENSIONS (in millimeters)

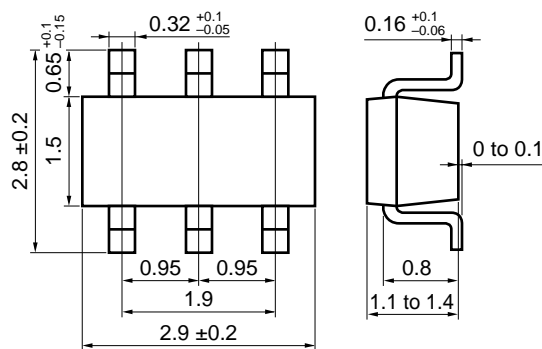

PIN CONNECTION (Top view)

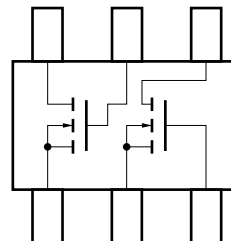

ABSOLUTE MAXIMUM RATINGS (T_A = 25 °C)

PARAMETER	SYMBOL	RATINGS	UNIT
Drain to Source Voltage	V _{DSS}	50	V
Gate to Source Voltage	V _{GSS}	±20	V
Drain Current (DC)	I _{D(DC)}	100	mA
Drain Current (pulse)	I _{D(pulse)*}	200	mA
Total Power Dissipation	P _T	300 (Total)	mW
Channel Temperature	T _{ch}	150	°C
Storage Temperature	T _{stg}	-55 to +150	°C

* PW ≤ 10 ms, Duty Cycle ≤ 50 %

ELECTRICAL CHARACTERISTICS (Ta = 25 °C)

PARAMETER	SYMBOL	TEST CONDITIONS	MIN.	TYP.	MAX.	UNIT
Drain Cut-off Current	I_{DSS}	$V_{DS} = 50\text{ V}, V_{GS} = 0$			1.0	μA
Gate Leakage Current	I_{GSS}	$V_{GS} = \pm 20\text{ V}, V_{DS} = 0$			± 1.0	μA
Gate Cut-off Voltage	$V_{GS(off)}$	$V_{DS} = 5.0\text{ V}, I_D = 1.0\ \mu\text{A}$	0.8	1.4	1.8	V
Forward Transfer Admittance	$ y_{fs} $	$V_{DS} = 5.0\text{ V}, I_D = 10\text{ mA}$	20			mS
Drain to Source On-State Resistance	$R_{DS(on)1}$	$V_{GS} = 4.0\text{ V}, I_D = 10\text{ mA}$		19	30	Ω
Drain to Source On-State Resistance	$R_{DS(on)2}$	$V_{GS} = 10\text{ V}, I_D = 10\text{ mA}$		15	25	Ω
Input Capacitance	C_{iss}	$V_{DS} = 5.0\text{ V}, V_{GS} = 0, f = 1.0\text{ MHz}$		16		pF
Output Capacitance	C_{oss}			12		pF
Reverse Transfer Capacitance	C_{rss}			3		pF
Turn-On Delay Time	$t_{d(on)}$	$V_{GS(on)} = 5.0\text{ V}, R_G = 10\ \Omega, V_{DD} = 5.0\text{ V}, I_D = 10\text{ mA}, R_L = 500\ \Omega$		17		ns
Rise Time	t_r			10		ns
Turn-Off Delay Time	$t_{d(off)}$			68		ns
Fall Time	t_f			38		ns

Marking: IA

SWITCHING TIME MEASUREMENT CIRCUIT AND CONDITIONS (RESISTANCE LOADED)

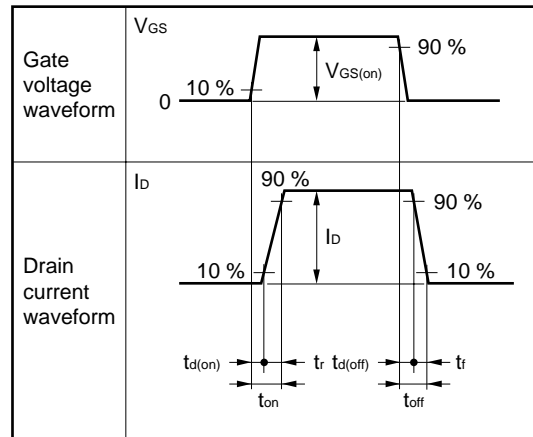
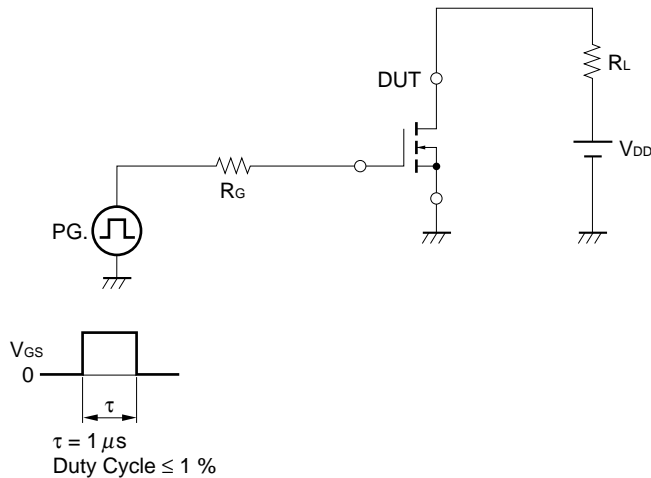

TYPICAL CHARACTERISTICS ($T_A = 25^\circ\text{C}$)

DERATING FACTOR OF FORWARD BIAS SAFE OPERATING AREA

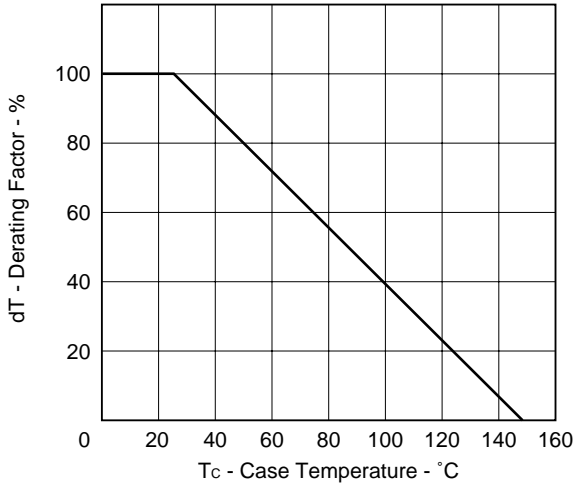

TOTAL POWER DISSIPATION vs. AMBIENT TEMPERATURE

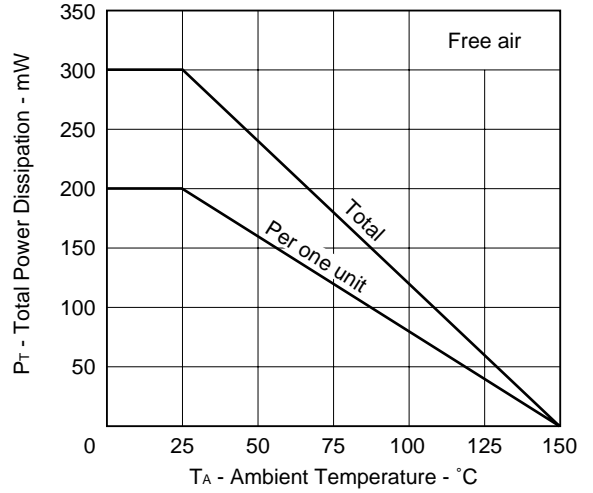

DRAIN CURRENT vs. DRAIN TO SOURCE VOLTAGE

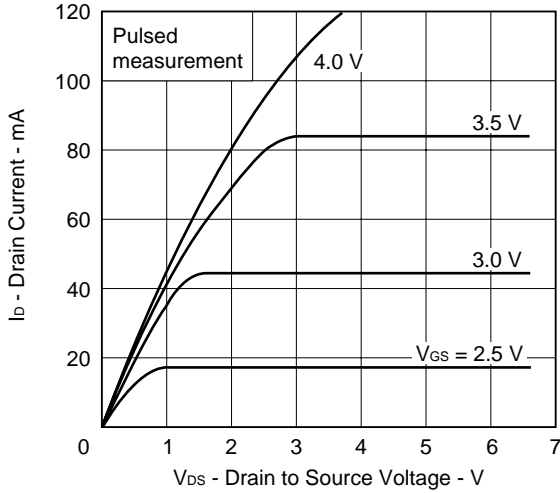

TRANSFER CHARACTERISTICS

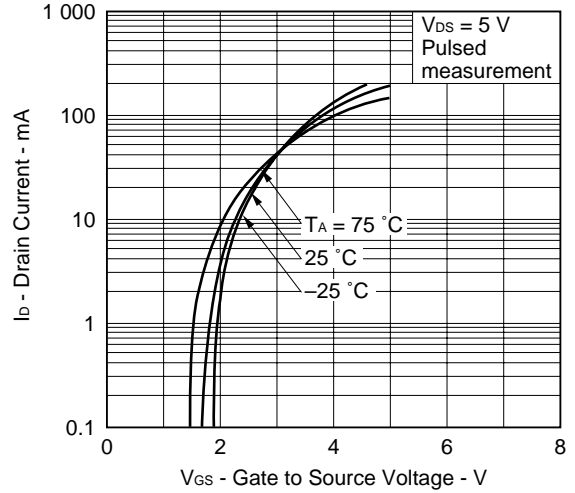

GATE TO SOURCE CUT-OFF VOLTAGE vs. CHANNEL TEMPERATURE

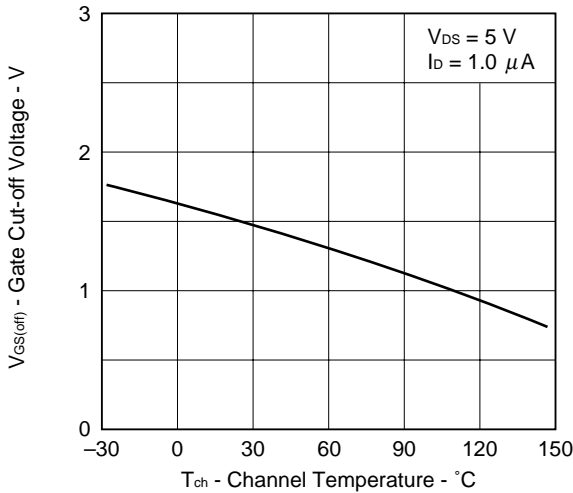

FORWARD TRANSFER ADMITTANCE vs. DRAIN CURRENT

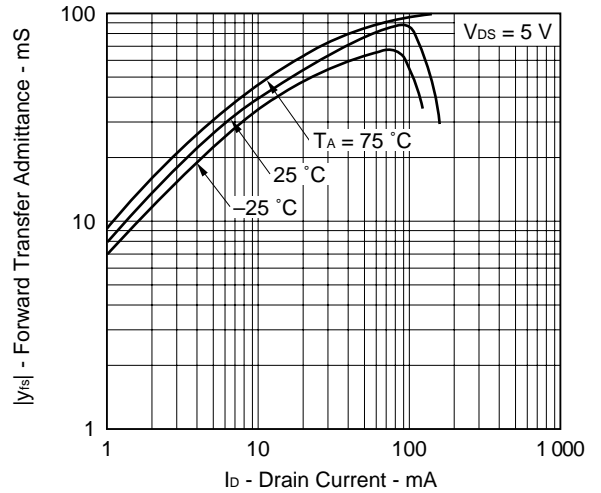

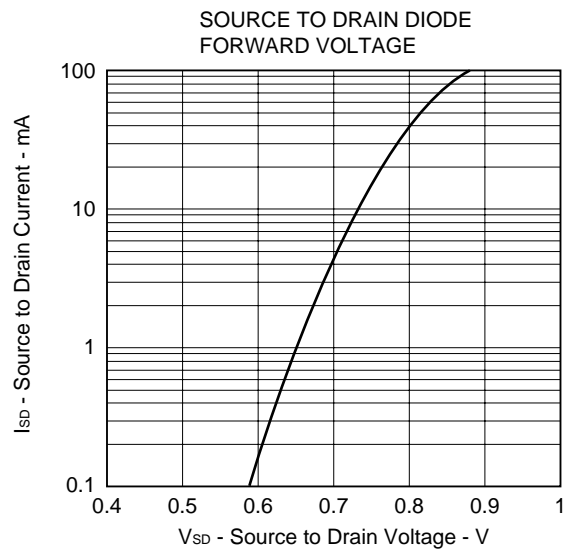
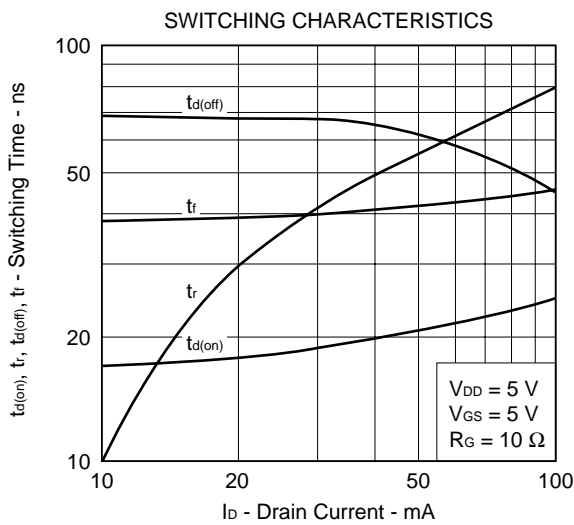
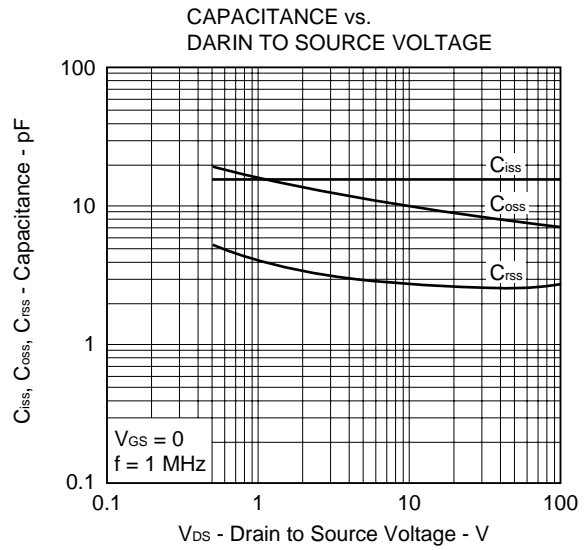
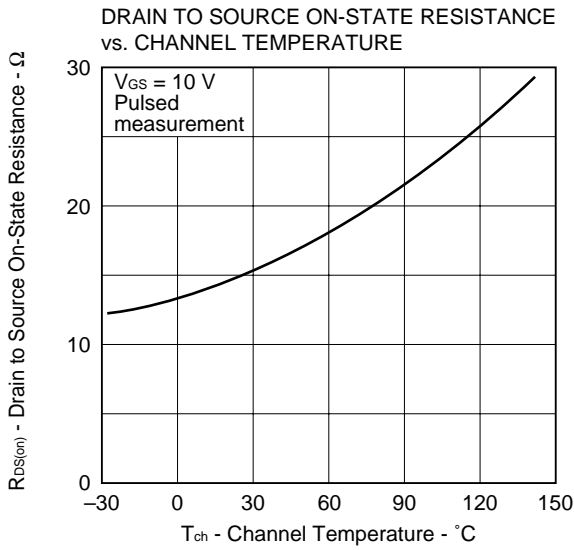
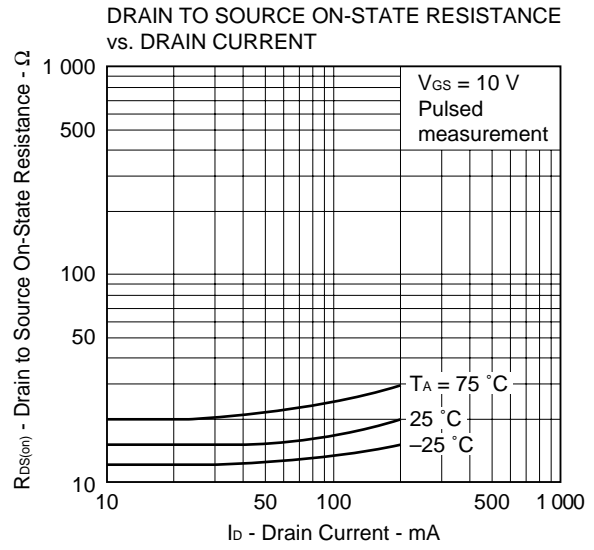
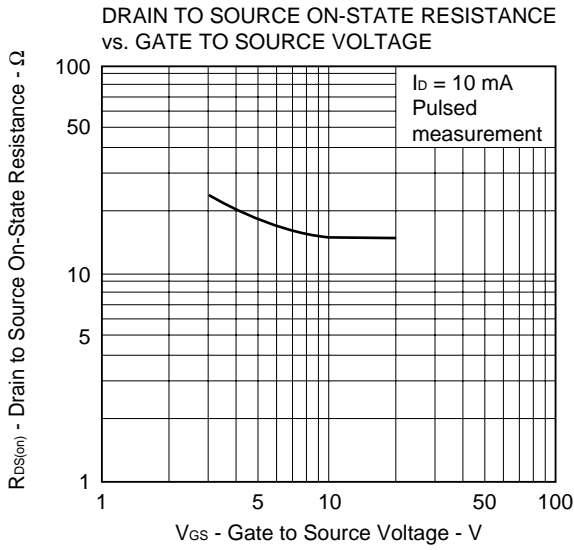

REFERENCE

Document Name	Document No.
NEC semiconductor device reliability/quality control system	TEI-1202
Quality grade on NEC semiconductor devices	IEI-1209
Semiconductor device mounting technology manual	C10535E
Guide to quality assurance for semiconductor devices	MEI-1202
Semiconductor selection guide	X10679E

No part of this document may be copied or reproduced in any form or by any means without the prior written consent of NEC Corporation. NEC Corporation assumes no responsibility for any errors which may appear in this document.

NEC Corporation does not assume any liability for infringement of patents, copyrights or other intellectual property rights of third parties by or arising from use of a device described herein or any other liability arising from use of such device. No license, either express, implied or otherwise, is granted under any patents, copyrights or other intellectual property rights of NEC Corporation or others.

While NEC Corporation has been making continuous effort to enhance the reliability of its semiconductor devices, the possibility of defects cannot be eliminated entirely. To minimize risks of damage or injury to persons or property arising from a defect in an NEC semiconductor device, customer must incorporate sufficient safety measures in its design, such as redundancy, fire-containment, and anti-failure features.

NEC devices are classified into the following three quality grades:

“Standard”, “Special”, and “Specific”. The Specific quality grade applies only to devices developed based on a customer designated “quality assurance program” for a specific application. The recommended applications of a device depend on its quality grade, as indicated below. Customers must check the quality grade of each device before using it in a particular application.

Standard: Computers, office equipment, communications equipment, test and measurement equipment, audio and visual equipment, home electronic appliances, machine tools, personal electronic equipment and industrial robots

Special: Transportation equipment (automobiles, trains, ships, etc.), traffic control systems, anti-disaster systems, anti-crime systems, safety equipment and medical equipment (not specifically designed for life support)

Specific: Aircrafts, aerospace equipment, submersible repeaters, nuclear reactor control systems, life support systems or medical equipment for life support, etc.

The quality grade of NEC devices in “Standard” unless otherwise specified in NEC's Data Sheets or Data Books. If customers intend to use NEC devices for applications other than those specified for Standard quality grade, they should contact NEC Sales Representative in advance.

Anti-radioactive design is not implemented in this product.