



BIPOLAR ANALOG INTEGRATED CIRCUIT

μ PC1197C

FM MULTIPLEX STEREO DEMODULATOR

SILICON MONOLITHIC BIPOLAR INTEGRATED CIRCUIT

DESCRIPTION

The μ PC1197C is a silicon monolithic integrated circuit for FM multiplex demodulator designed for stereo cassette tape recorder with radio receiver, car stereo and car radio operated at a low supply voltage.

The circuit consists of a voltage control oscillator (VCO) for a demodulator and a phase locked loop (PLL), phase comparators, low pass filters (LPF), frequency dividers and a DC amplifier. It also contains accessory circuits such as separation adjustor stereo-monaural switcher, VCO stopper and stereo-monaural switcher in depressed supply voltage.

FEATURES

- No coil is needed due to PLL (Phase Locked Loop) system. The absence of coil, essential component in conventional systems, enable to reduce the number of external components and save manpower for adjustments.
- The circuit provides stability in a wide range of power supply voltage. ($V_{CC} = 4$ to 16 V)
- A stereo/monaural switch can be controlled by a DC voltage obtained from IF signal by smoothing. It is also designed to provide very small shock noise generated when the stereo/monaural is switched.
- VCO, an unnecessary function for AM reception, can be stopped simply by connecting the control terminal to the power supply. ($V_{CC} - 3.0$ V)
- When the power supply voltage is depressed the mode is forced to shift to monaural. (Forced monaural reception; $V_{CC} - 3.5$ V)
- Separation adjustment terminal enables to adjust optimum channel separation.

BLOCK DIAGRAM

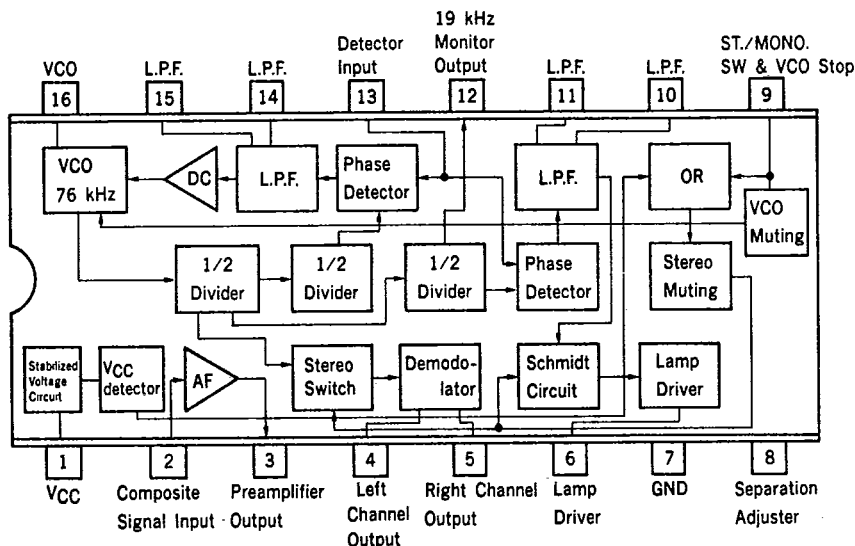

ABSOLUTE MAXIMUM RATINGS (Ta = 25 °C)

Power Supply Voltage	V _{CC}	16	V
Allowable Power Dissipation	P _D	350*	mW
Operational Temperature	T _{opt}	-20 to +75	°C
Storage Temperature	T _{stg}	-40 to +125	°C

*Ta = 75 °C

RECOMMENDED OPERATION CONDITIONS (Ta = 25 °C)

Supply Voltage Range	V _{CC}	4 to 16 V
Operating Voltage	V _{CC}	9 V

ELECTRICAL CHARACTERISTICS (Ta = 25 °C, V_{CC} = 9 V, v_i = 200 mV, L = 45 %, R = 45 %, Pilot = 10 %)

CHARACTERISTIC	SYMBOL	MIN.	TYP.	MAX.	UNIT	CONDITION
Circuit Current	I _{CC}		12		mA	Without signal
Separation	Sep.	30	45		dB	f = 100 Hz
		40	55		dB	f = 1 kHz
		30	45		dB	f = 10 kHz
Monaural Total Harmonic Distortion	T.H.D.		0.3	0.5	%	monaural V _i = 200 mV
Stereo Total Harmonic Distortion	T.H.D.		0.2	0.5	%	stereo pilot = 20 mV
Output Voltage	V _O		170		mV	V _i = 200 mV
Channel Balance	Ch. B.	-2	0	2	dB	monaural V _i = 200 mV
Lamp-on Level	LAMP-ON		8		mV	pilot signal
Lamp Hysteresis	Hys. (LAMP)		4		dB	pilot signal
Capture Range	C.R.		±4		%	pilot = 20 mV
Ultrasonic Frequency Rejection	Rej (19)		35		dB	pilot = 20 mV
	Rej (38)		45		dB	pilot = 20 mV
SCA Rejection ratio	Rej (SCA)		70		dB	$\frac{\text{pilot}}{\text{composite}} = \frac{1}{10}$ $\frac{\text{SCA}}{\text{composite}} = \frac{1}{10}$
Signal to Noise Ratio	S/N		86		dB	V _i = 200 mV
Allowed Maximum Input Level	V _i (MAX)		500		mV	T.H.D. ≤ 2%
Forced-monaural Level	V (MONO)		0.7		V	#9 terminal
VCO-stop level	V (STOP)		3.0		V	#9 terminal
Stereo-monaural Switch-over Voltage	V _{CC} (MONO)		3.5		V	Supply Voltage

TEST CIRCUIT

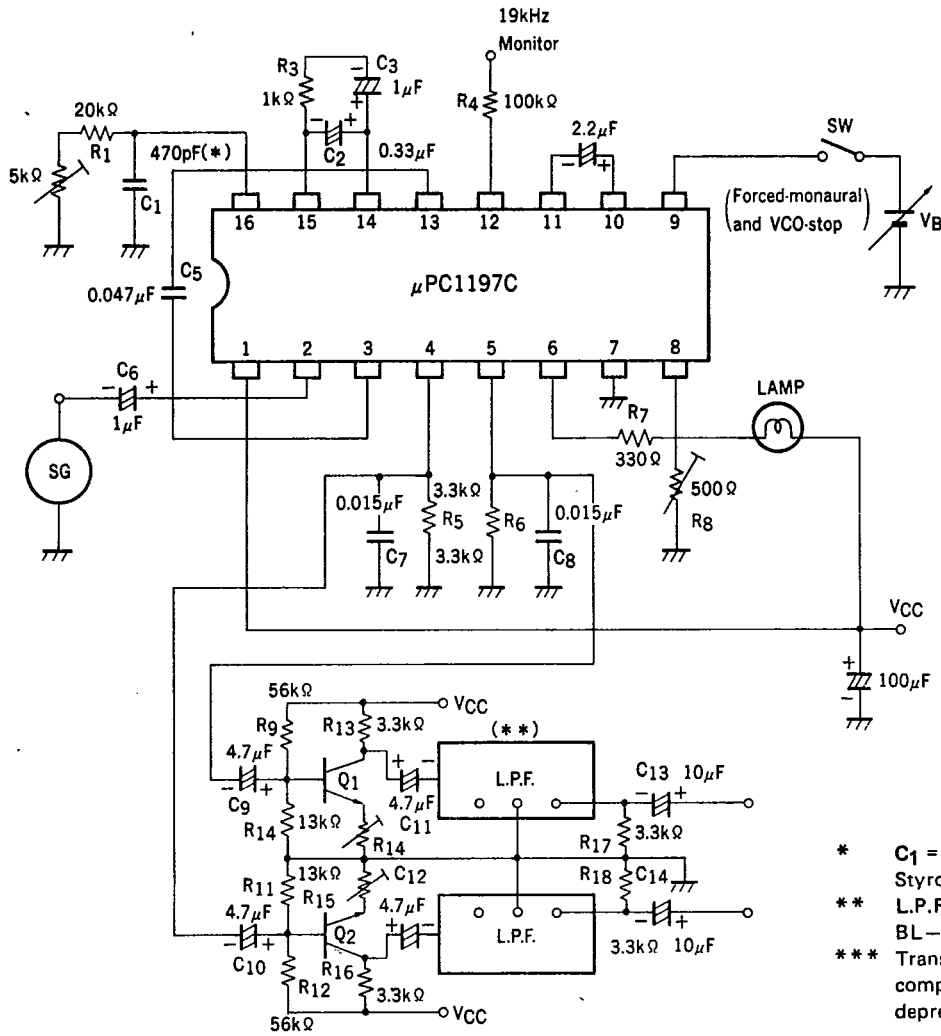

- * C₁ = 470 pF
Styrol Capacitor
- ** L.P.F.
BL-13 (K.K. KORIN)
- *** Transistors Q₁ and Q₂
compensate the gain
depression through LPF's

PACKAGE DIMENSIONS

in millimeters (inches)

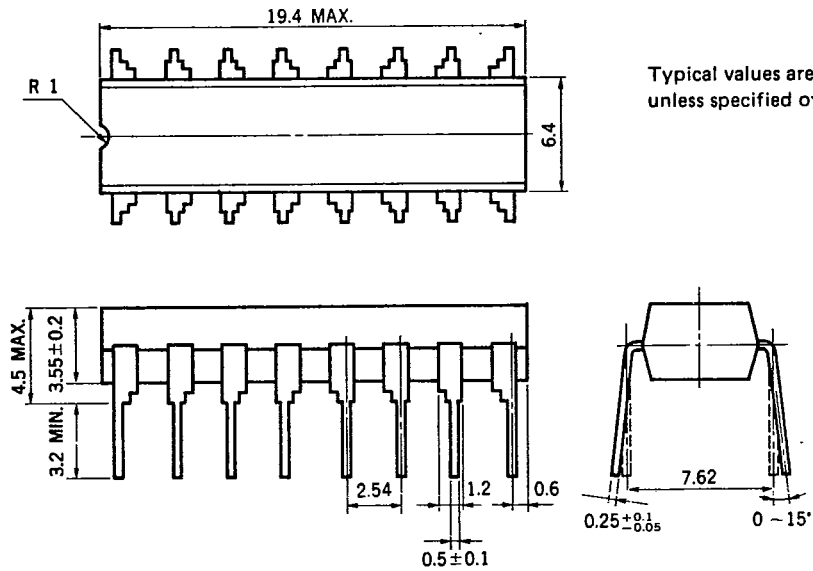

TYPICAL APPLICATION CIRCUIT

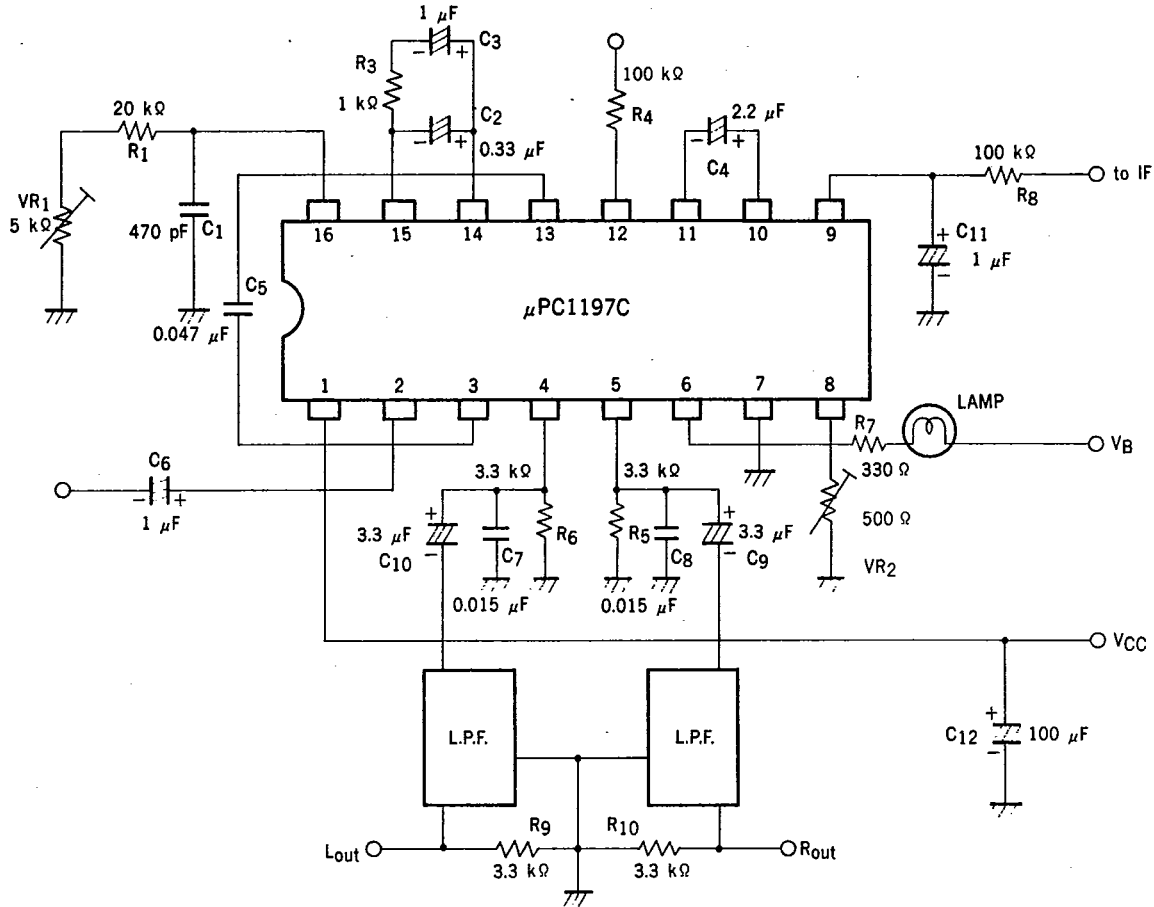

PRECAUTIONS NEEDED IN APPLICATIONS

- (1) The μPC1197C is designed to have a temperature coefficient which is equivalent to that of styrol capacitors.
- (2) Terminal #9 is provided for forced-monaural switching and VCO stop. If a voltage of 0.7 volt or more is applied to the terminal, the operation is switched over to monaural and if a voltage of 3 volts or more is applied, VCO is stopped. For a power supply voltage higher than 10 volts, insert a resistance satisfying the following formula between the power supply and terminal #9.

$$1.1 [V_{CC}(\text{MAX}) - 10] = R = 2[V_{CC}(\text{MIN}) - 4] \text{ (k}\Omega\text{)},$$
 where $V_{CC}(\text{MAX})$ and $V_{CC}(\text{MIN})$ and lower limits of power supply voltage that satisfy the voltage regulation requirement, respectively.

TYPICAL CIRCUIT BOARD ARRANGEMENT (VIEW OF PRINTED WIRING)

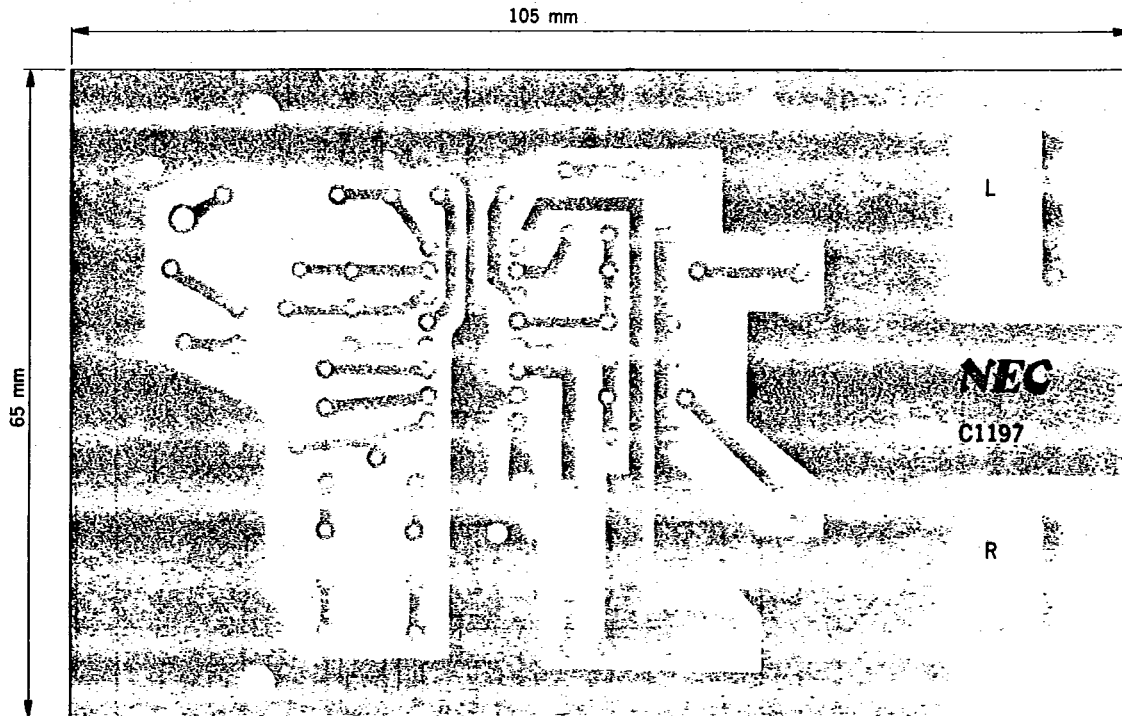

TYPICAL PARTS LOADING (TYPICAL APPLICATION)

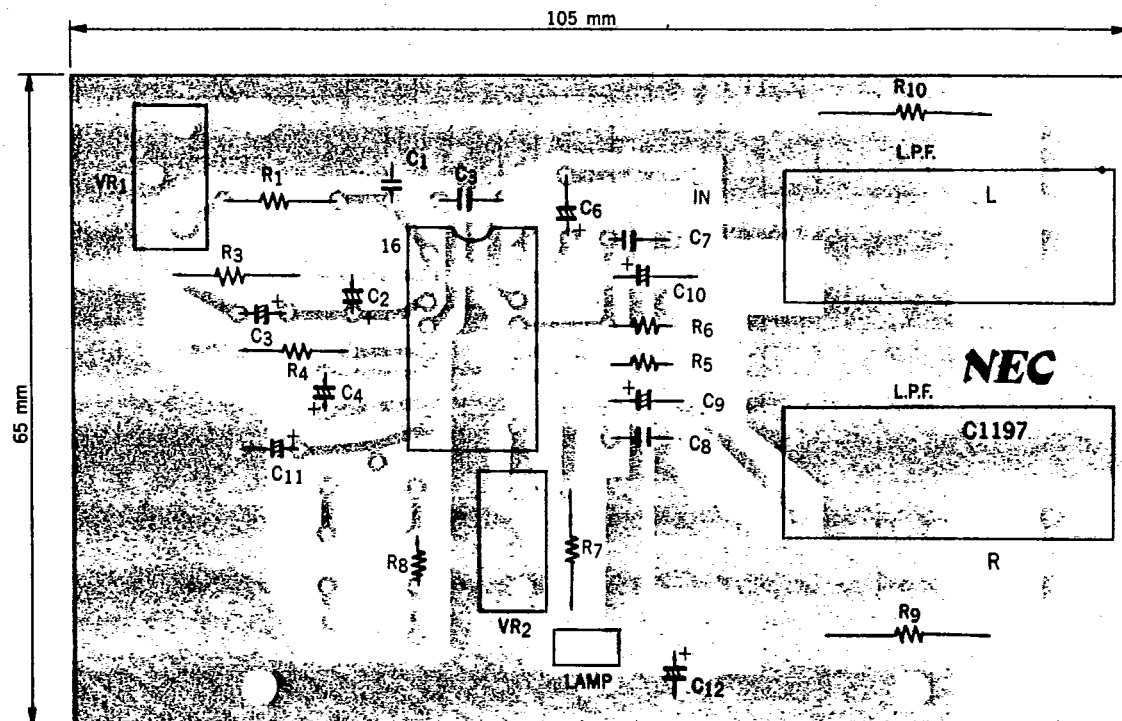

- | | | | |
|-------------------------|--------------------------|--|---------------------------|
| R ₁ = 18 kΩ | R ₇ = 330 Ω | C ₁ = 470 pF (Styrol Capacitor) | C ₇ = 0.015 μF |
| VR ₁ = 5 kΩ | R ₈ = 100 kΩ | C ₂ = 0.33 μF | C ₈ = 0.015 μF |
| R ₃ = 1 kΩ | R ₉ = 3.3 kΩ | C ₃ = 1 μF | C ₉ = 3.3 μF |
| R ₄ = 100 kΩ | R ₁₀ = 3.3 kΩ | C ₄ = 2.2 μF | C ₁₀ = 3.3 μF |
| R ₅ = 3.3 kΩ | | C ₅ = 0.047 μF | C ₁₁ = 1 μF |
| R ₆ = 3.3 kΩ | | C ₆ = 1 μF | C ₁₂ = 100 μF |

DESCRIPTION OF EXTERNALLY LOADED COMPONENT PARTS

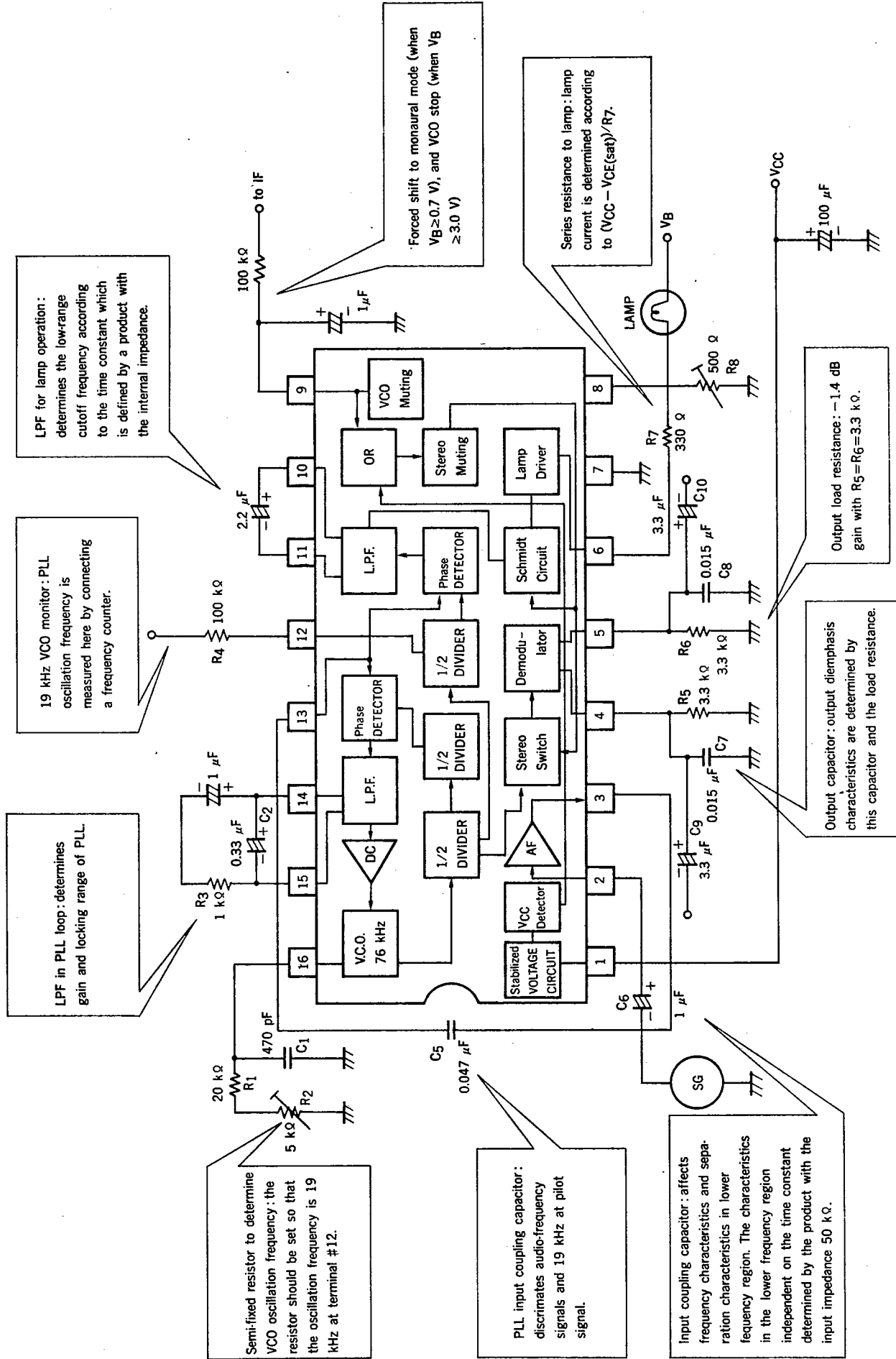

TYPICAL CHARACTERISTICS

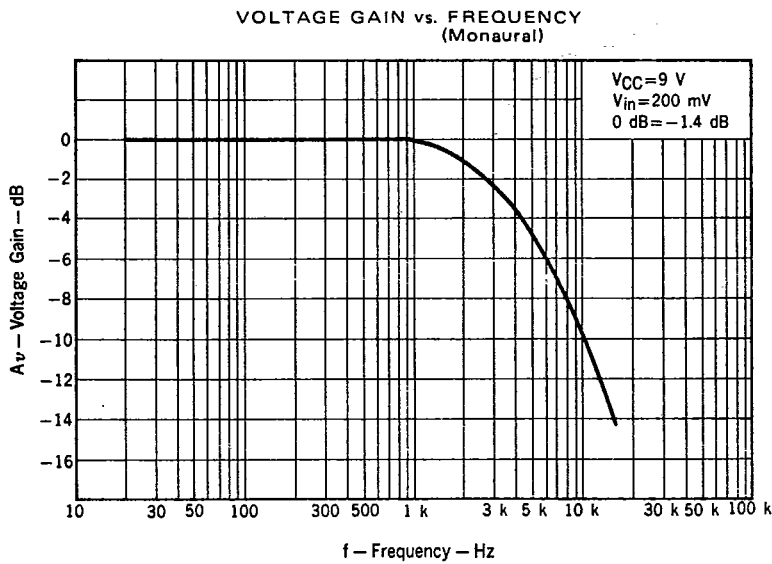
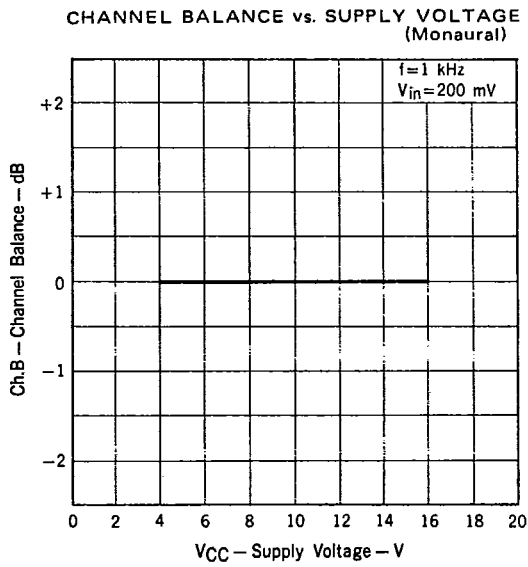
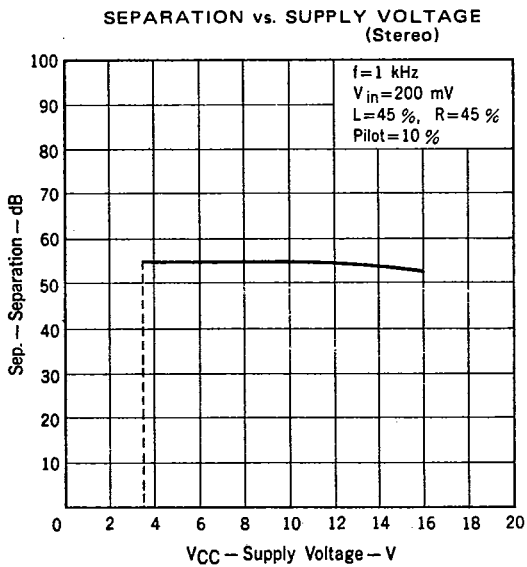
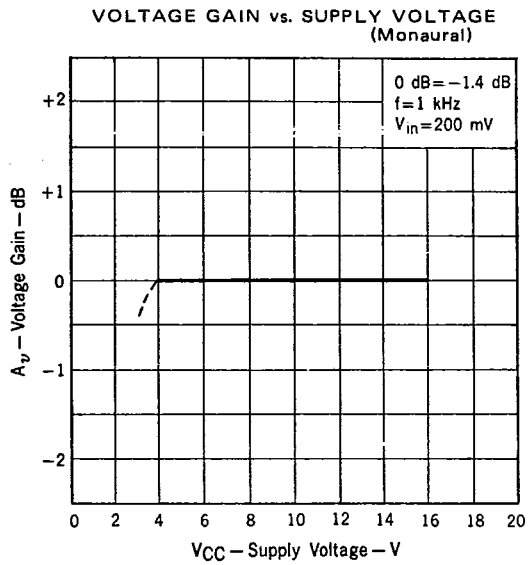
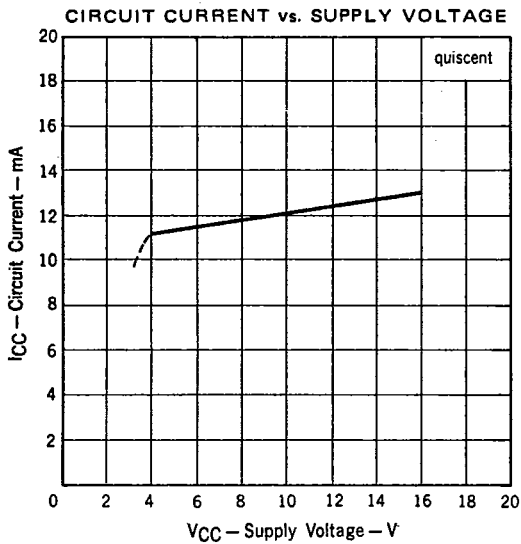

259

SEPARATION vs. FREQUENCY (Stereo)

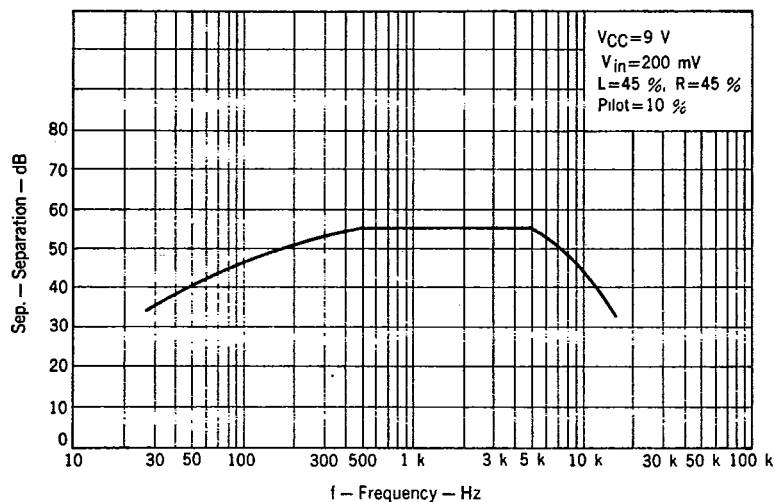

VCO FREE RUNNING FREQUENCY vs. SUPPLY VOLTAGE

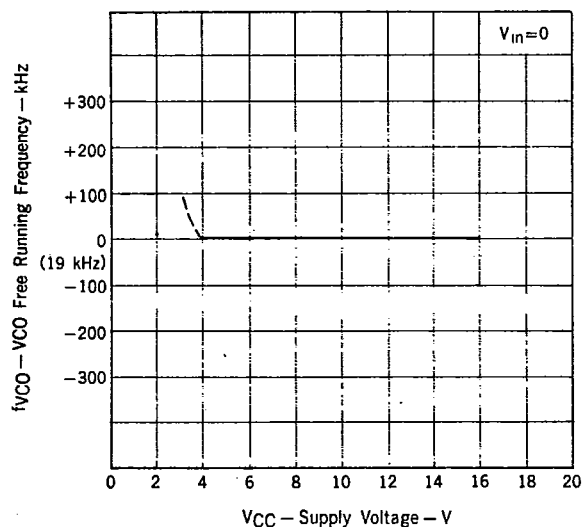

SEPARATION vs. PILOT INPUT LEVEL (Stereo)

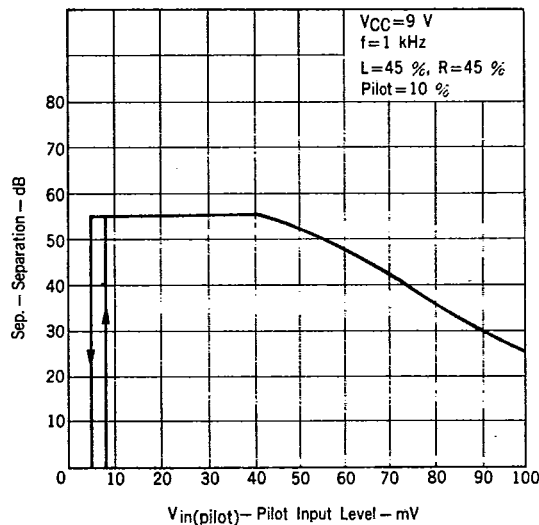

TOTAL HARMONIC DISTORTION vs. SIGNAL INPUT LEVEL (Monaural)

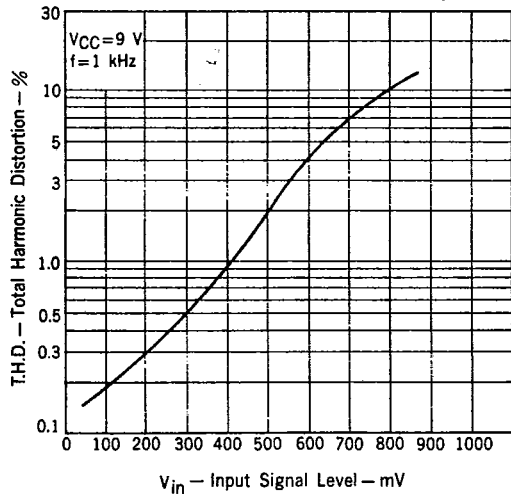

TOTAL HARMONIC DISTORTION vs. SUPPLY VOLTAGE (Monaural)

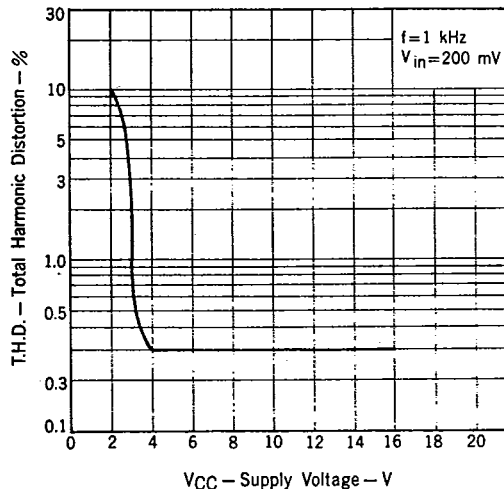

260

TOTAL HARMONIC DISTORTION vs. FREQUENCY (Monaural)

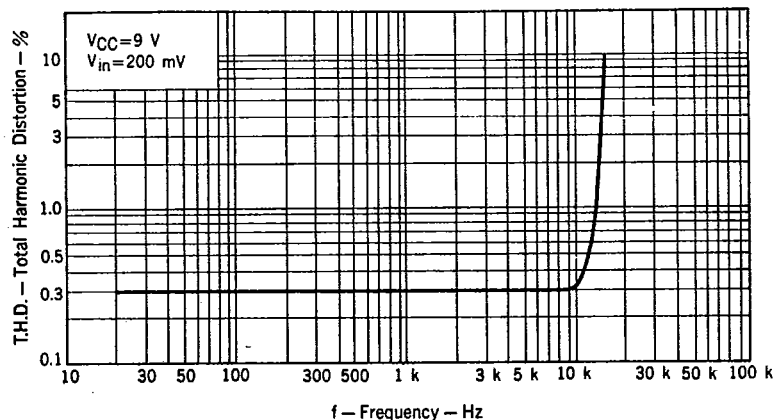

TOTAL HARMONIC DISTORTION vs. FREQUENCY (Stereo)

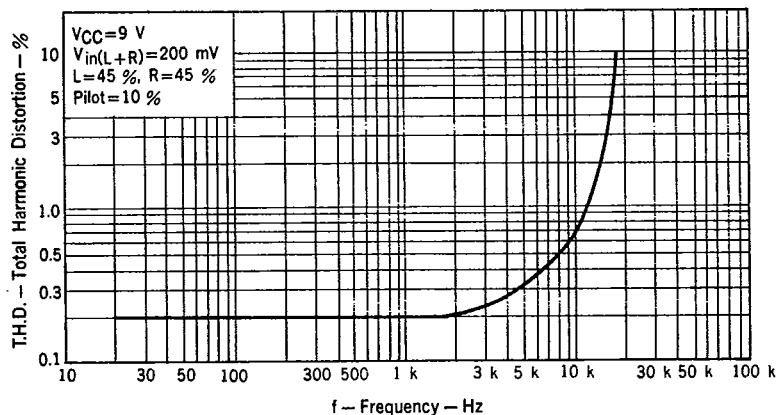

TOTAL HARMONIC DISTORTION vs. PILOT INPUT LEVEL (Stereo)

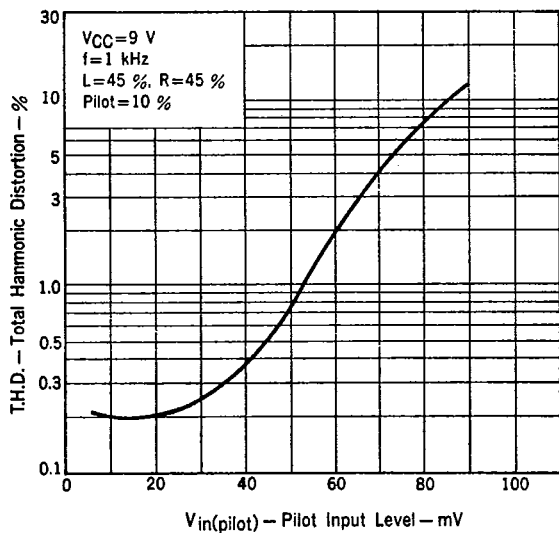

MAXIMUM INPUT LEVEL vs. SUPPLY VOLTAGE (Monaural)

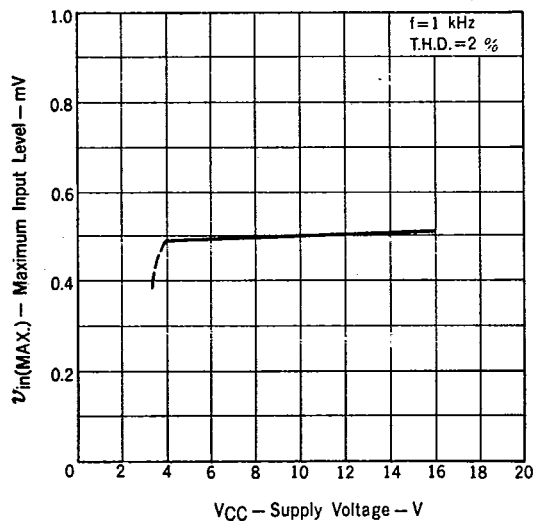

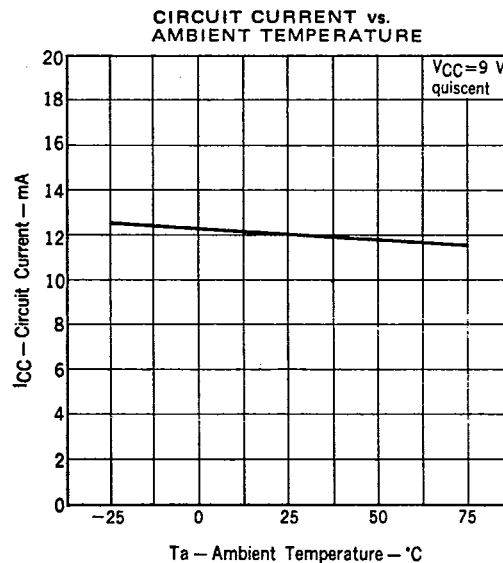
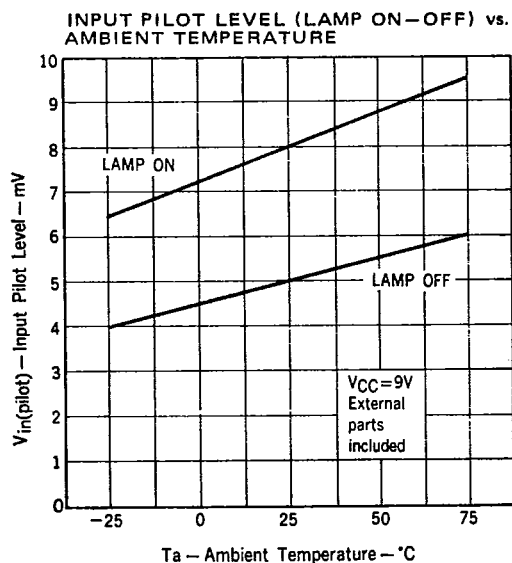
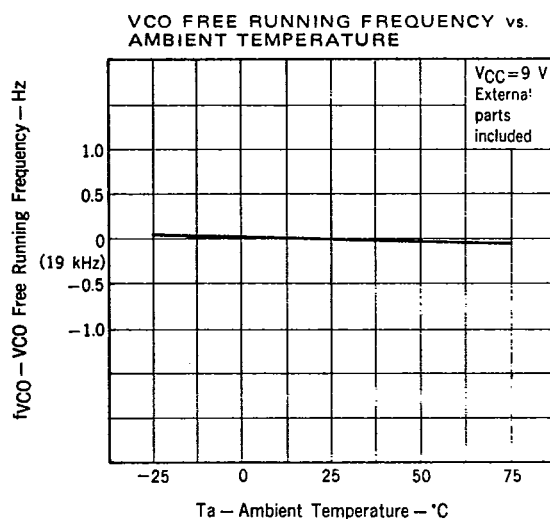
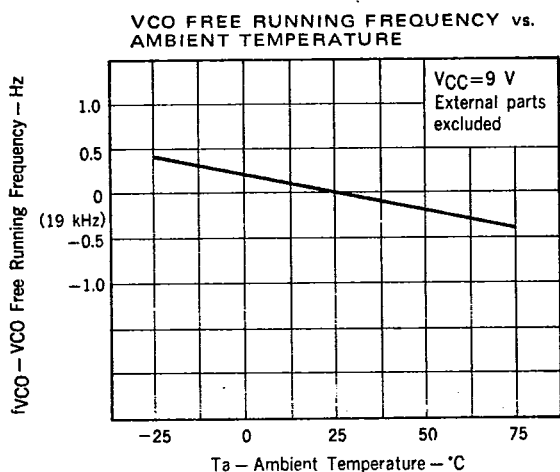
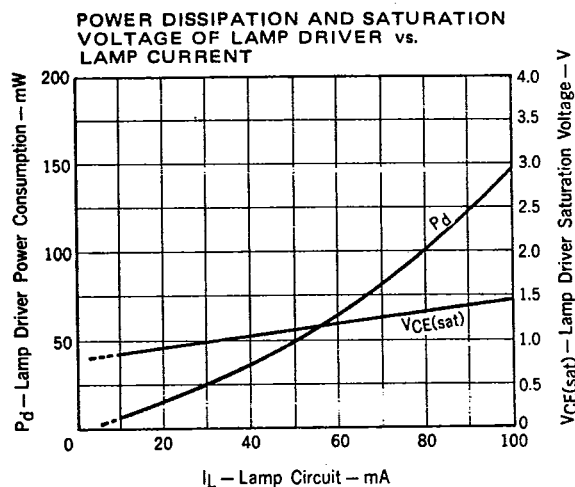
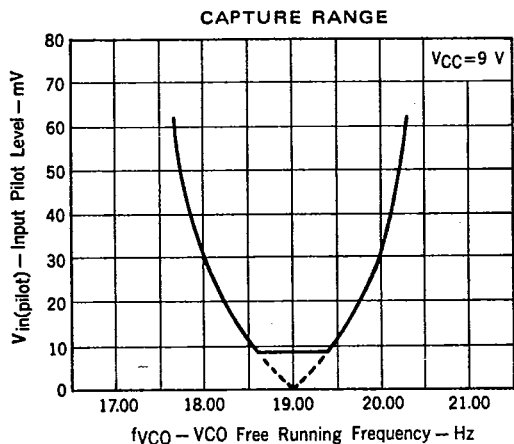

Nippon Electric Co., Ltd.

262
 NEC Building, 33-1, Shiba-Gochome, Minato-ku, Tokyo 108, Japan
 Tel: Tokyo 454-1111
 Telex Address: NECTOK J22686
 Cable Address: MICROPHONE TOKYO

IC-1410
 AUG. - 10 - 81M
 Printed in Japan