

CONNECTION DIAGRAM (Top View)

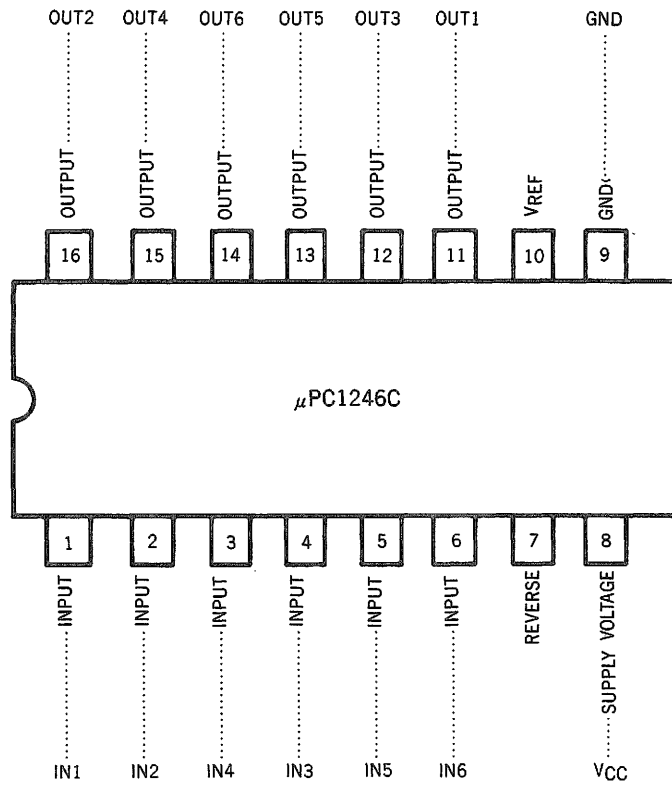

ABSOLUTE MAXIMUM RATINGS (Ta = 25 °C)

Supply Voltage	V _{CC}	18	V
Input Voltage to Differential Amp.	V _{ID}	5	V
Common Mode Input Voltage	V _{ICM}	0.3 to V _{CC}	V
Terminal Voltage to V _{REF}	V _{REF}	0 to V _{CC}	V
Reverse Terminal Voltage	V _{REV}	0 to V _{CC}	V
Power Dissipation	P _D Ta = 70 °C	390	mW
Operating Temperature	T _{opt}	-10 to 70	°C
Storage Temperature	T _{stg}	-55 to 125	°C

RECOMMENDED OPERATING CONDITIONS

CHARACTERISTIC	SYMBOL	MIN.	TYP.	MAX.	UNIT
Supply Voltage	V _{CC}	9	12	15	V
Common Mode Input Voltage	V _{ICM}	1.5		V _{CC} -1.5	V
V _S -Output Current	V _S -I _O	Ref. Fig. 1 ~ 3 Within Area of Oblique Lines			

ELECTRICAL CHARACTERISTICS (T_a = 25 °C, V_{CC} = 12 V)

CHARACTERISTIC	SYMBOL	MIN.	TYP.	MAX.	UNIT	CONDITIONS
Circuit Current	I _{CC}	2	4.5	7.5	mA	V _{REF} = 0
Input/Output Characteristics		-5	0	5	deg	
Input Offset Voltage	V _{OFF}	-4.2	0	4.2	mV	V _{ICM} = 1.5 to 10.5 V
Input Bias Current	I _B	-	50	600	nA	V _{ICM} = 6 V
Propagation Delay Time	T _{pd}	-	3	-	μs	V _I = 5 mV, V _{REF} = 10 V, V _O = 9 V
Output Voltage H (11, 12, 13 PIN)	V _{OH}	8.9	9.3	9.6	V	V _{REF} = 10 V, R _L = 470 Ω
Output Voltage L (14, 15, 16 PIN)	V _{OL}	8.2	8.6	9.0	V	V _{REF} = 8 V, R _L = 470 Ω
Output Leak Current	I _S	-	-	5	μA	Ref. PAGE 6, 8

Fig. 1 OUTPUT CURRENT vs. SERVO VOLTAGE

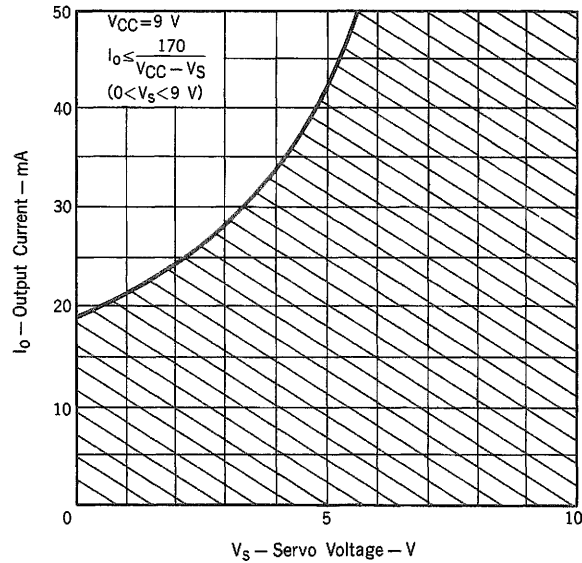

Fig. 2 OUTPUT CURRENT vs. SERVO VOLTAGE

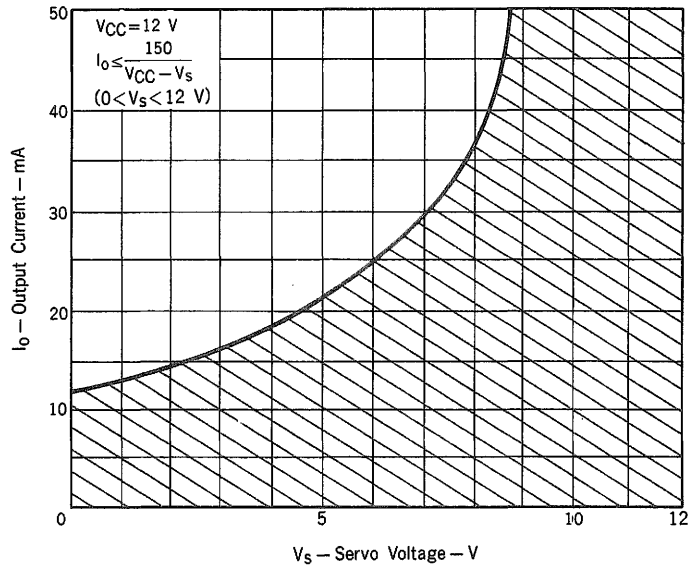
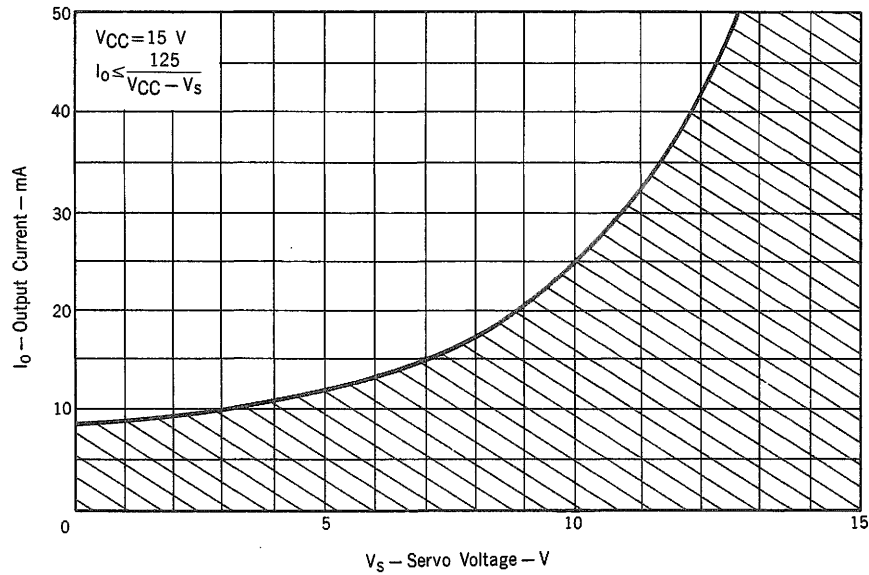
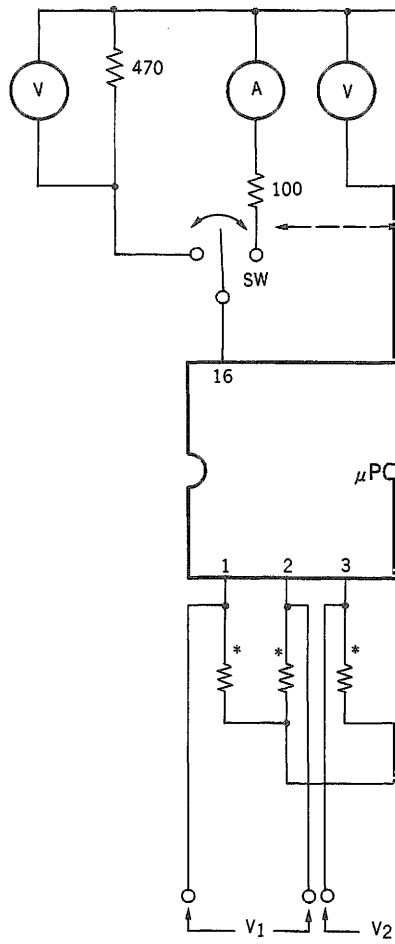

Fig. 3 OUTPUT CURRENT vs. SERVO VOLTAGE



TEST CIRCUIT 1

- INPUT/OUTPUT CHARACTERISTIC
- PROPAGATION DELAY TIME



TEST CIRCUIT 2

- OUTPUT LEAKAGE CURRENT I_s

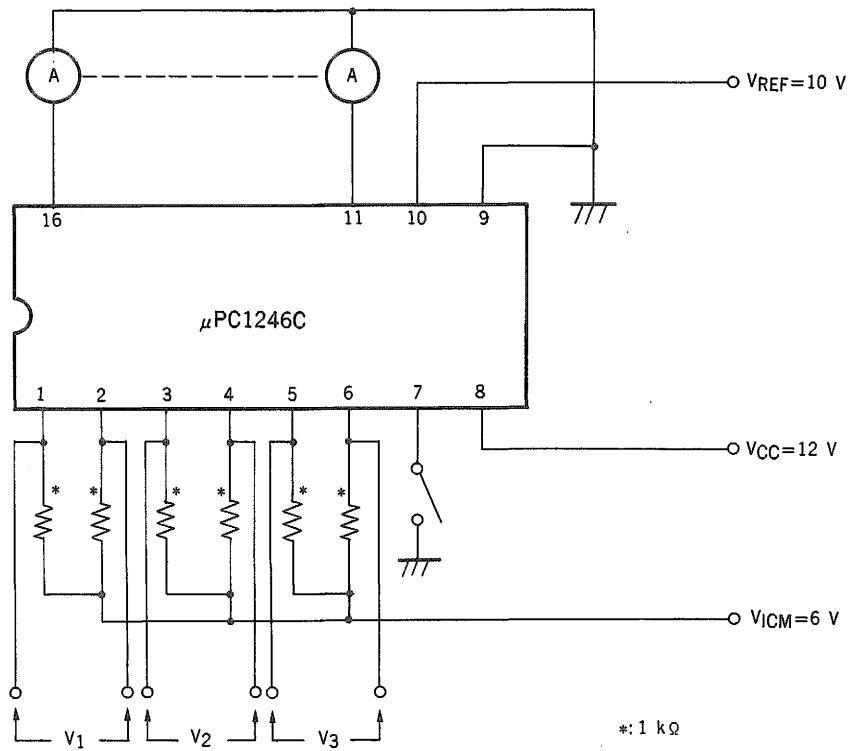

TEST CIRCUIT 3

- CHARACTERISTIC OF SERVO VOLTAGE (V_s) – LOAD CURRENT (I_L)

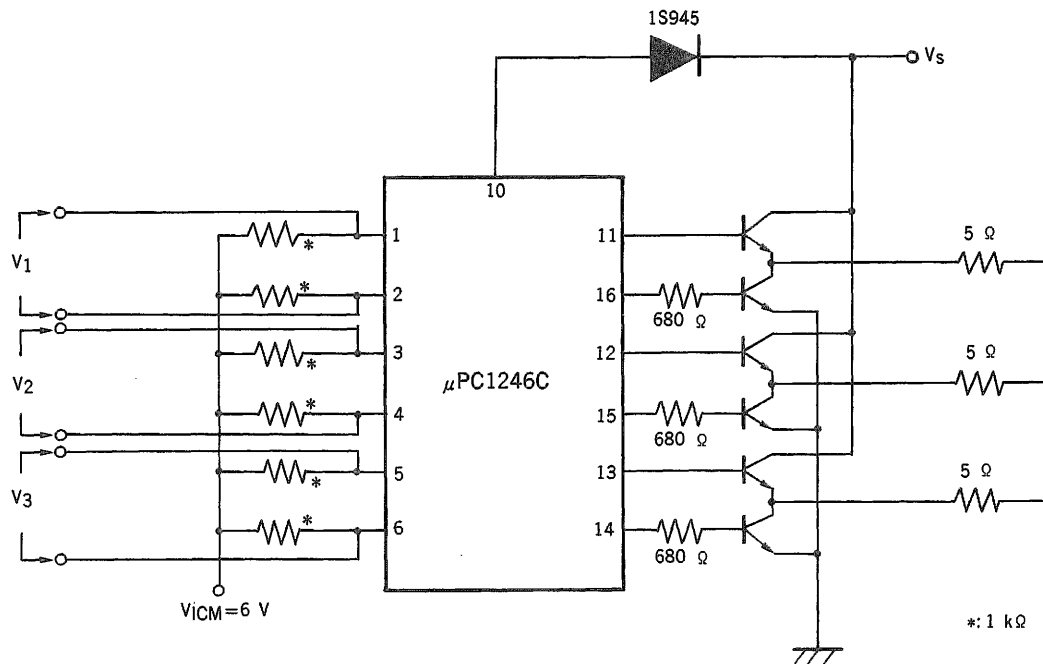

Input Condition is as same as TABLE 1. (See PAGE8)

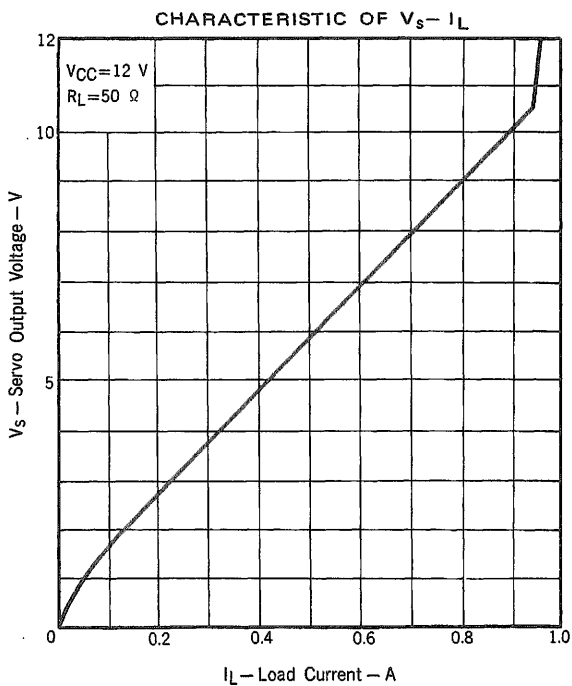

INPUT CONDITION FOR MEASUREMENT

● INPUT/OUTPUT CHARACTERISTIC

TABLE 1		IN CASE OF 7 PIN OPEN			IN CASE OF 7 PIN SHORT		
TERMINAL OF MEASUREMENT	INPUT CONDITION	V ₁	V ₂	V ₃	V ₁	V ₂	V ₃
11		V _L	V _H	/	V _H	V _L	/
12		/	V _L	V _H	/	V _H	V _L
13		V _H	/	V _L	V _L	/	V _H
14		V _L	/	V _H	V _H	/	V _L
15		/	V _H	V _L	/	V _L	V _H
16		V _H	V _L	/	V _L	V _H	/

INPUT LEVEL

$5\text{ mV} \leq V_H \leq 50\text{ mV}$ OR $-50\text{ mV} \leq V_L \leq 5\text{ mV}$

● PROPAGATION DELAY TIME

TABLE 2		IN CASE OF 7 PIN OPEN			IN CASE OF 7 PIN SHORT		
TERMINAL OF MEASUREMENT	INPUT CONDITION	V ₁	V ₂	V ₃	V ₁	V ₂	V ₃
11		V _{IN}	V _L	/	V _L	V _{IN}	/
12		/	V _{IN}	V _L	/	V _L	V _{IN}
13		V _L	/	V _{IN}	V _{IN}	/	V _L
14		V _{IN}	/	V _L	V _L	/	V _{IN}
15		/	V _L	V _{IN}	/	V _{IN}	V _L
16		V _L	V _{IN}	/	V _{IN}	V _L	/

INPUT LEVEL

$V_{IN} = 5\text{ mV}$, $f \leq 10\text{ kHz}$, Duty 50 % PULSE WAVE $-50\text{ mV} \leq V_L < -5\text{ mV}$

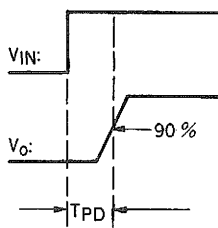

● OUTPUT LEAKAGE CURRENT I_S

INPUT CONDITION FOR MEASUREMENT

TABLE 3		IN CASE OF 7 PIN OPEN			IN CASE OF 7 PIN SHORT		
TERMINAL OF MEASUREMENT	INPUT CONDITION	V ₁	V ₂	V ₃	V ₁	V ₂	V ₃
11		V _H	V _L	/	V _L	V _H	/
12		/	V _H	V _L	/	V _L	V _H
13		V _L	/	V _H	V _H	/	V _L
14		V _H	/	V _L	V _L	/	V _H
15		/	V _L	V _H	/	V _H	V _L
16		V _L	V _H	/	V _H	V _L	/

INPUT LEVEL

$-50\text{ mV} \leq V_L \leq -5\text{ mV}$, $5\text{ mV} \leq V_H \leq 50\text{ mV}$

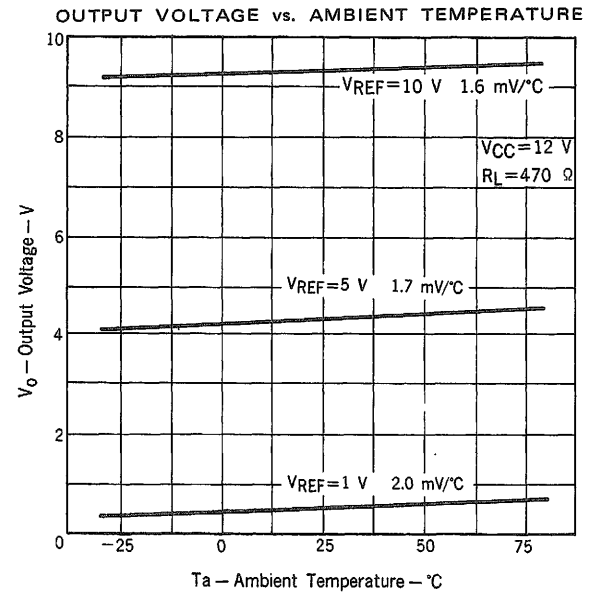
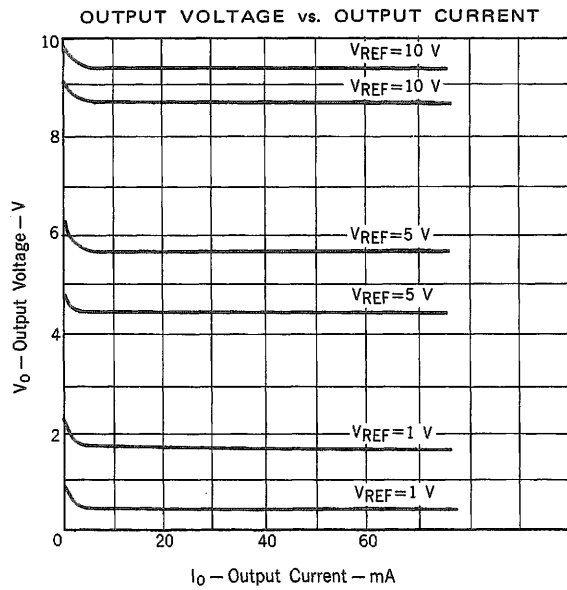
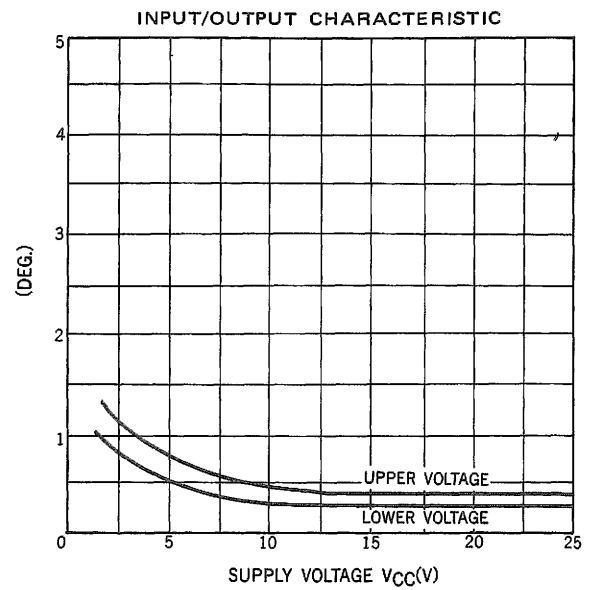
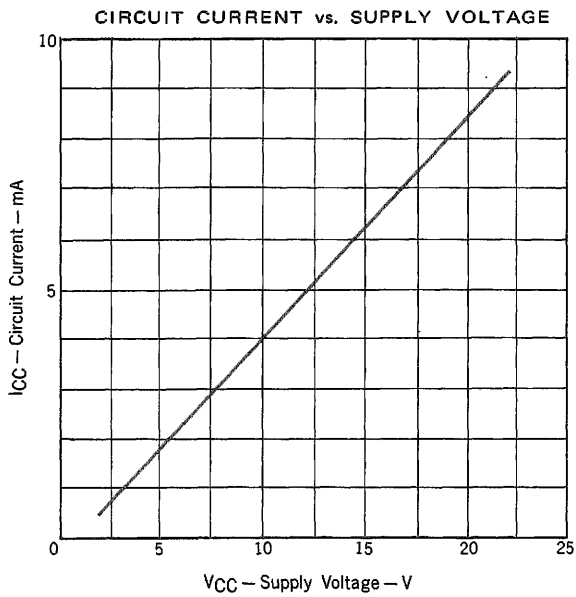

APPLICATION

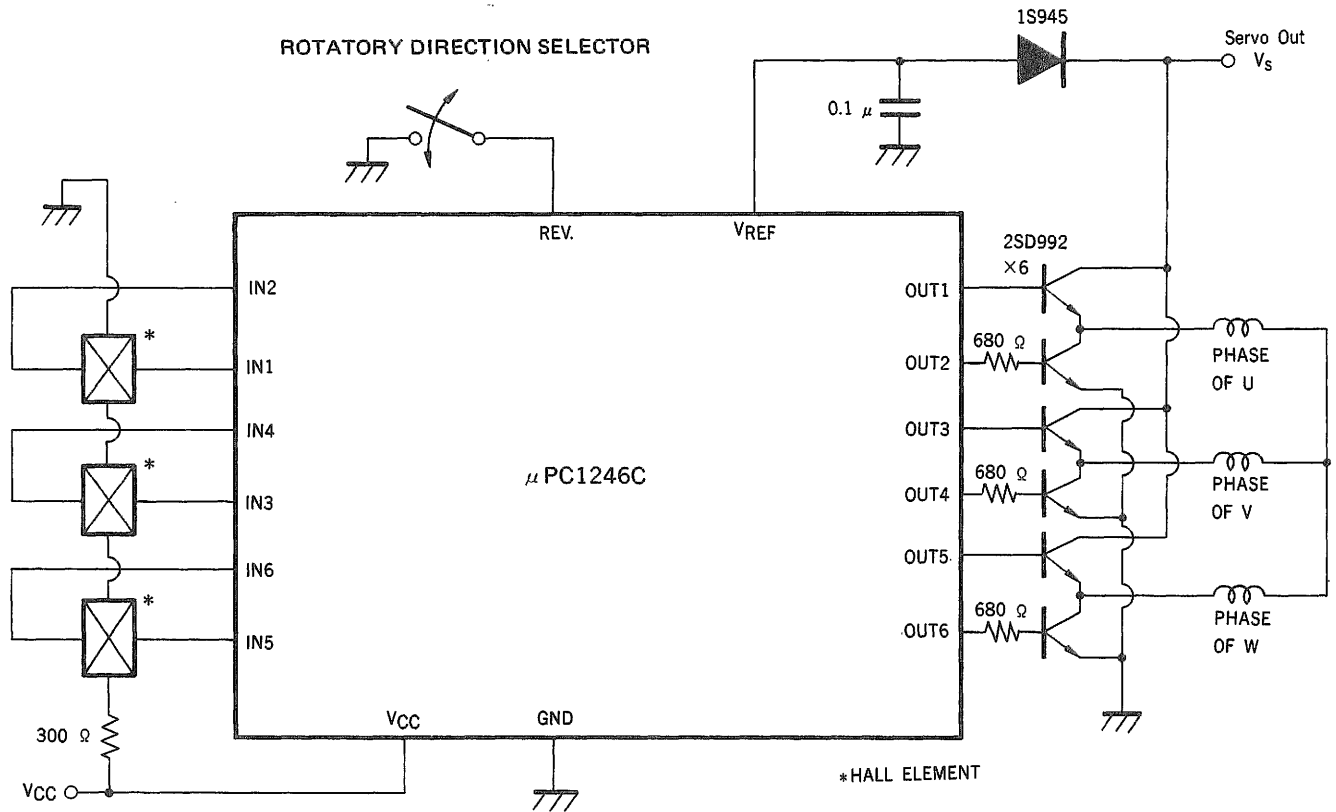

Nippon Electric Co., Ltd.

NEC Building, 33-1, Shiba-Gochome, Minato-ku, Tokyo 108, Japan
Tel: Tokyo 454 - 1111
Telex Address: NECTOK J22686
Cable Address: MICROPHONE TOKYO

IC-1413
SEPT.-30-81M
Printed in Japan