

FEATURES

- **HIGH OUTPUT POWER:** +18 dBm PSAT
- **EXCELLENT FREQUENCY RESPONSE:**
2.0 GHz TYP at 3 dB Down
- **HIGH POWER GAIN:** 23 dB TYP at 500 MHz
- **SINGLE SUPPLY VOLTAGE:** 5 V
- **AVAILABLE IN TAPE AND REEL**

DESCRIPTION

The UPC1678 is a silicon monolithic integrated circuit designed as a wide-band amplifier covering the HF to UHF bands. The device features high output power, 18 dBm TYP, high gain, 23 dB TYP and operates from a single 5 volt supply. The UPC1678 is available in two package styles: 8 pin SOP and SSOP packages.

NEC's stringent quality assurance and test procedures ensure the highest reliability and performance.

NOISE FIGURE AND GAIN
vs. FREQUENCY AND VOLTAGE

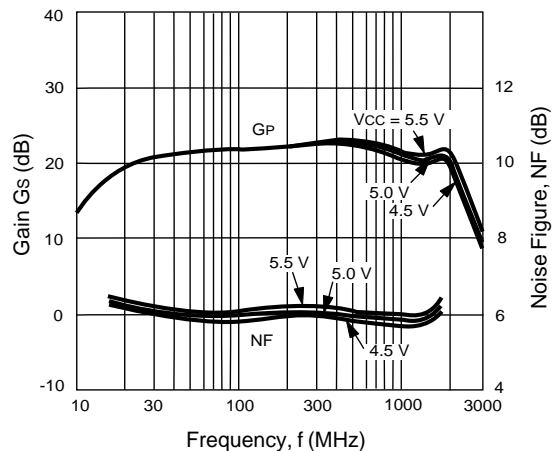

ELECTRICAL CHARACTERISTICS (TA = 25°C, VCC = +5 V, f = 500 MHz)

PART NUMBER PACKAGE OUTLINE			UPC1678G, GV G08, S08		
SYMBOLS	PARAMETERS AND CONDITIONS	UNITS	MIN	TYP	MAX
I _{CC}	Circuit Current at No Input Signal	mA	40	49	60
G _s	Small Signal Gain	dB	21	23	25
f _{3dB}	Upper Limit Operating Frequency at 3 dB down below the Gain at 100 MHz	MHz	1700	2000	
P _{SAT}	Saturated Output Power	dBm	15.5	17.5	
NF	Noise Figure	dB		6	
RLIN	Input Return Loss	dB	11	14	
RLOUT	Output Return Loss	dB	1	4	
ISOL	Isolation	dB	30	35	

UPC1678G, UPC1678GV

ABSOLUTE MAXIMUM RATINGS¹ (T_A = 25°C)

SYMBOLS	PARAMETERS	UNITS	RATINGS
V _{CC}	Power Supply Voltage	V	-0.5 to 6.0
P _{IN}	Input Power	dBm	+10
P _T	Total Power Dissipation ² UPC1678G, GV	mW	330
T _{OP}	Operating Temperature UPC1678G, GV	°C	-45 to +85
T _{STG}	Storage Temperature UPC1678G, GV	°C	-55 to +150

Notes:

1. Operation in excess of any one of these parameters may result in permanent damage.
2. Mounted on 5 cm x 5 cm x 1.6 mm glass epoxy PWB at T_A = maximum operating temperature..

EQUIVALENT CIRCUIT

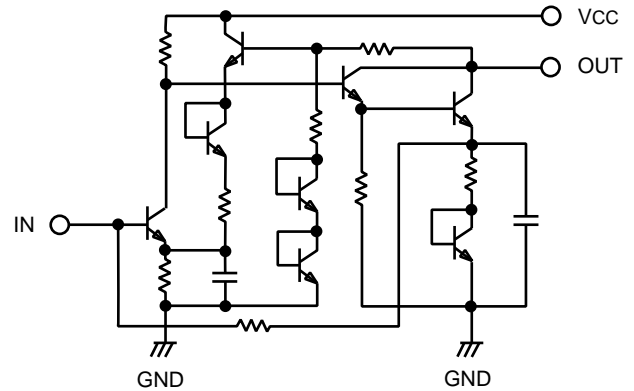

RECOMMENDED OPERATING CONDITIONS

SYMBOLS	CHARACTERISTICS	UNITS	MIN	TYP	MAX
V _{CC}	Supply Voltage	V	4.5	5.0	5.5
T _{OP}	Operating Temperature	°C	-40	+25	+85

TYPICAL PERFORMANCE CURVES (T_A = 25°C)

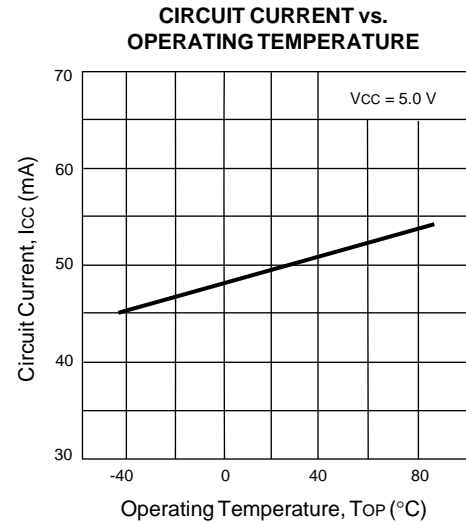
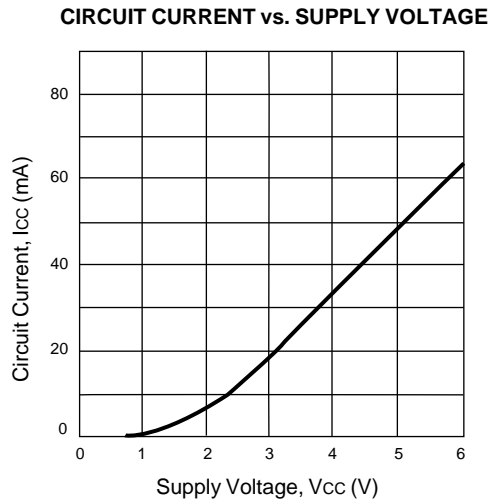

TYPICAL PERFORMANCE CURVES (TA = 25°C)

UPC1678G, GV
ISOLATION vs. FREQUENCY

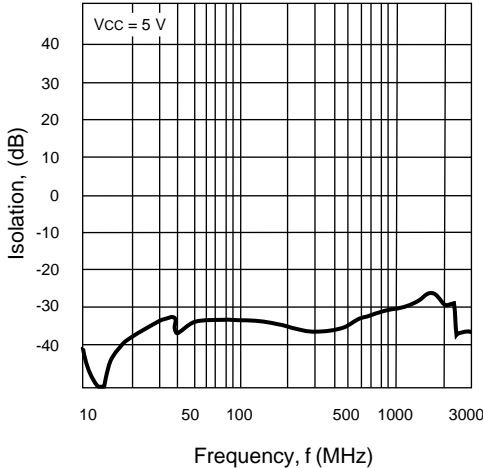

UPC1678G, GV
INPUT RETURN LOSS vs. FREQUENCY

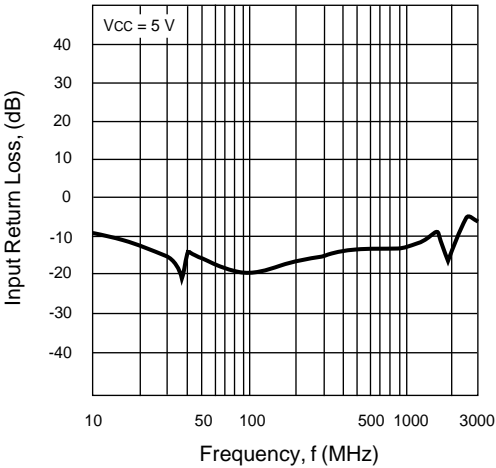

UPC1678G, GV
OUTPUT RETURN LOSS vs. FREQUENCY

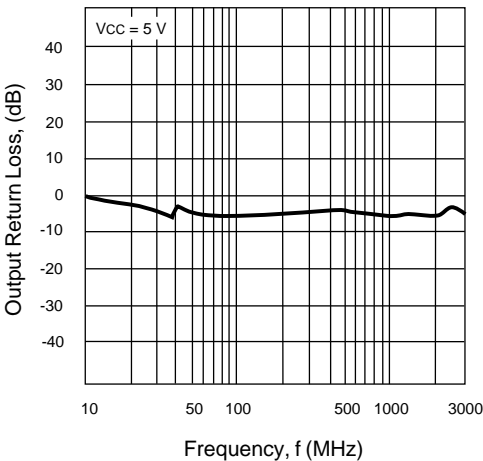

UPC1678G, GV
OUTPUT POWER vs. INPUT POWER

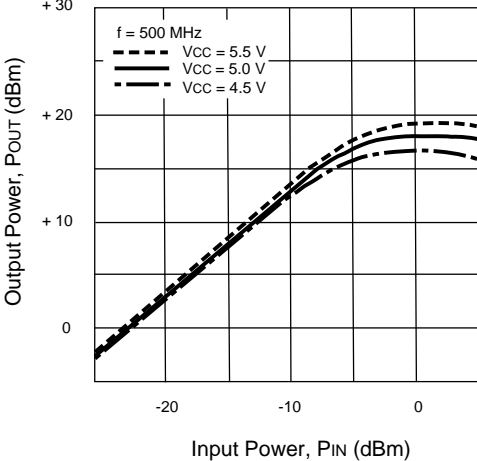

UPC1678G, UPC1678GV

TYPICAL PERFORMANCE CURVES (TA = 25°C)

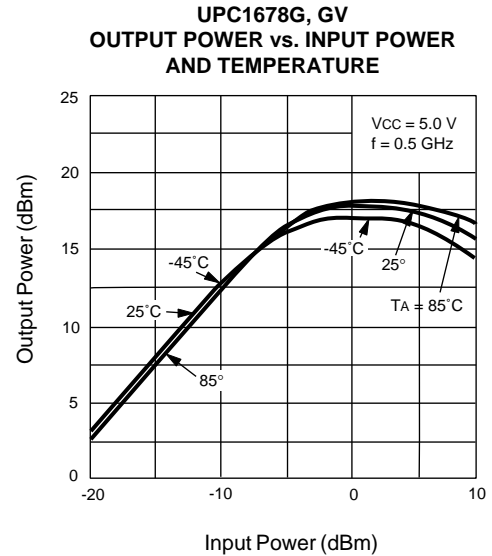
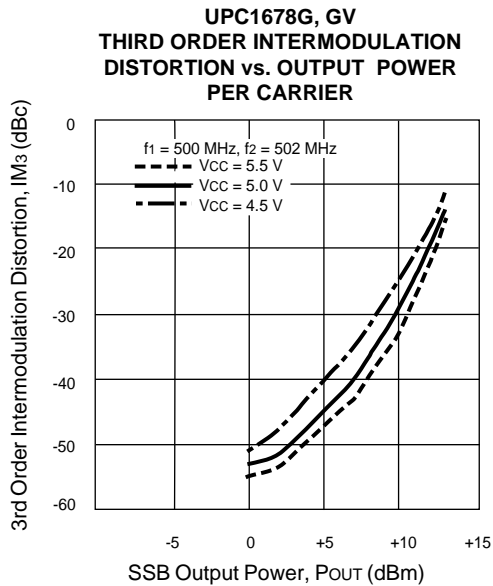
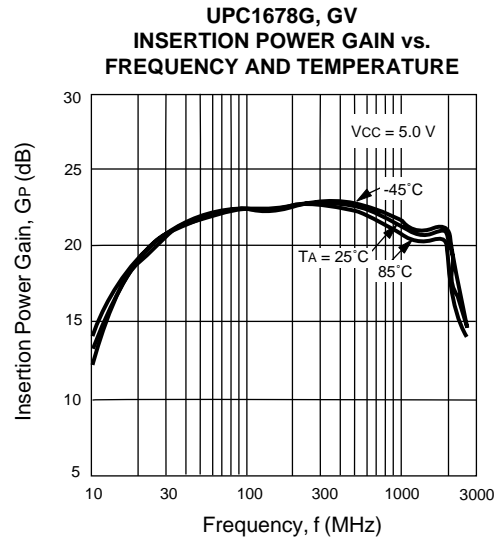
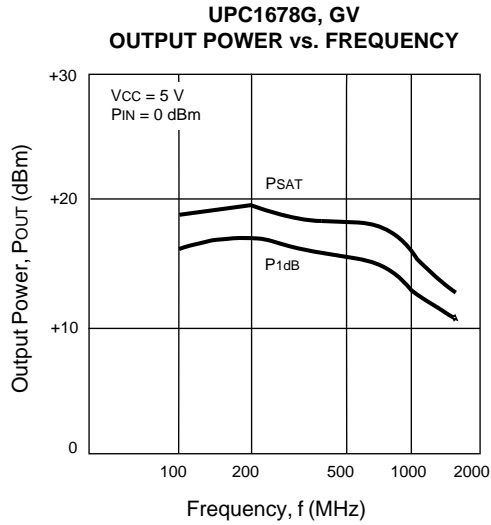

TEST CIRCUIT

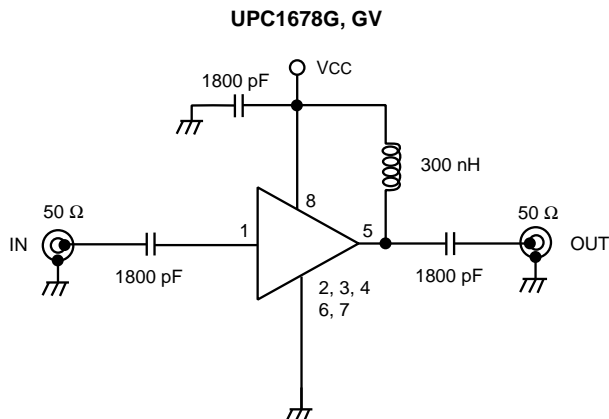

Precautions: 1) These devices are ESD sensitive. Use proper precautionary measures when handling and installing these devices.

TYPICAL SCATTERING PARAMETERS ($T_A = 25^\circ\text{C}$)**UPC1678G**V_{CC} = 5 V, I_{CC} = 51 mA

FREQUENCY (GHz)	S ₁₁		S ₂₁		S ₁₂		S ₂₂		K	S ₂₁ (dB)
	MAG	ANG	MAG	ANG	MAG	ANG	MAG	ANG		
0.05	0.193	143	9.9	31	0.018	26	0.746	91	1.45	23.5
0.10	0.126	151	12.6	6	0.020	10	0.610	44	1.43	24.1
0.20	0.138	136	13.6	-23	0.018	-13	0.618	6	1.47	24.8
0.40	0.208	88	14.4	-70	0.015	-7	0.691	-44	1.35	26.4
0.60	0.248	43	14.0	-111	0.022	-19	0.681	-85	0.97	28.1
0.80	0.256	2	13.1	-152	0.028	-38	0.635	-121	0.89	26.7
1.00	0.239	-35	12.5	170	0.034	-57	0.610	-155	0.83	25.6
1.20	0.190	-72	11.9	129	0.038	-87	0.646	167	0.77	24.9
1.40	0.152	-115	11.9	92	0.044	-109	0.634	136	0.75	24.4
1.60	0.093	-173	11.4	53	0.045	-136	0.669	98	0.73	24.0
1.80	0.042	81	10.0	8	0.043	-169	0.697	53	0.80	23.6
2.00	0.167	37	9.1	-30	0.041	171	0.626	9	0.98	23.4
2.20	0.214	-7	7.4	-70	0.034	145	0.579	-35	1.46	19.4
2.40	0.256	-38	6.1	-107	0.031	122	0.523	-77	1.99	17.2
2.50	0.292	-53	5.5	-127	0.028	116	0.469	-98	2.49	16.1

UPC1678GVV_{CC} = 5 V, I_{CC} = 50 mA

FREQUENCY (GHz)	S ₁₁		S ₂₁		S ₁₂		S ₂₂		K	S ₂₁ (dB)
	MAG	ANG	MAG	ANG	MAG	ANG	MAG	ANG		
0.05	0.136	157	10.2	36	0.018	3	0.683	89	1.59	23.0
0.10	0.106	164	12.1	18	0.025	26	0.609	53	1.25	23.8
0.20	0.126	165	13.2	3	0.020	15	0.621	22	1.34	24.6
0.40	0.174	144	14.4	-17	0.017	50	0.673	-10	1.24	26.4
0.60	0.184	119	15.0	-35	0.024	71	0.657	-37	0.85	27.9
0.80	0.150	107	14.6	-52	0.033	75	0.619	-64	0.78	26.5
1.00	0.102	115	15.1	-70	0.038	77	0.599	-89	0.78	26.0
1.20	0.112	148	14.0	-88	0.040	83	0.585	-116	0.81	25.4
1.40	0.169	151	12.4	-114	0.046	92	0.542	-142	0.81	24.4
1.60	0.180	137	11.3	-131	0.054	99	0.449	-163	0.86	23.2
1.80	0.146	121	7.6	-144	0.063	101	0.335	-177	1.10	18.8
2.00	0.072	89	6.2	-159	0.073	102	0.224	-177	1.25	16.2
2.20	0.045	-37	4.6	-157	0.081	100	0.192	-163	1.49	13.4
2.40	0.137	-84	3.9	-164	0.085	97	0.206	-157	1.60	12.1
2.50	0.180	-95	3.9	-161	0.088	95	0.219	-158	1.54	12.2

UPC1678G, UPC1678GV

OUTLINE DIMENSIONS (Units in mm)

**UPC1678G
PACKAGE OUTLINE G08**

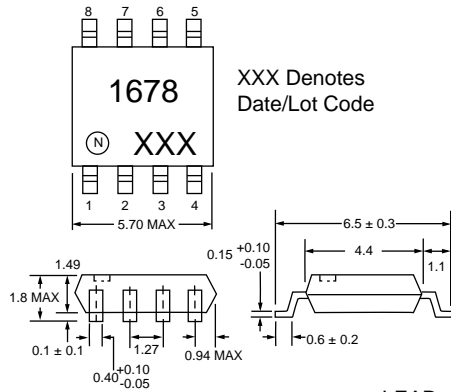

XXX Denotes
Date/Lot Code

- LEAD
CONNECTIONS**
- | | |
|----------|-----------|
| 1. Input | 5. Output |
| 2. GND | 6. GND |
| 3. GND | 7. GND |
| 4. GND | 8. Vcc |

**UPC1678GV
PACKAGE OUTLINE S08**

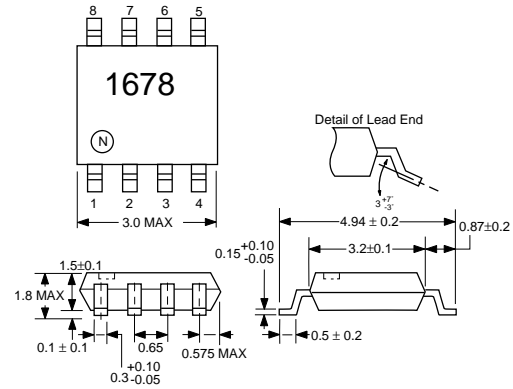

- LEAD
CONNECTIONS**
- | | |
|----------|-----------|
| 1. Input | 5. Output |
| 2. GND | 6. GND |
| 3. GND | 7. GND |
| 4. GND | 8. Vcc |

ORDERING INFORMATION

PART NUMBER	QTY
UPC1678G-E1	2500/REEL
UPC1678GV-E1	1000/REEL

EXCLUSIVE NORTH AMERICAN AGENT FOR **NEC** RF, MICROWAVE & OPTOELECTRONIC SEMICONDUCTORS

CEL CALIFORNIA EASTERN LABORATORIES • Headquarters • 4590 Patrick Henry Drive • Santa Clara, CA 95054-1817 • (408) 988-3500 • Telex 34-6393 • FAX (408) 988-0279

24-Hour Fax-On-Demand: 800-390-3232 (U.S. and Canada only) • Internet: <http://WWW.CEL.COM>

DATA SUBJECT TO CHANGE WITHOUT NOTICE

PRINTED IN USA ON RECYCLED PAPER -9/96