

SWITCHING REGULATOR CONTROL IC

The μ PC1909 is a switching regulator control IC ideal for primary side control of active-clamp type^{Note} DC/DC converters. This IC has 2 outputs employing a totem-pole circuit with peak output current 1.2 A, and is capable of directly driving a power MOS-FET. As a result, it has been possible to realize primary side control of an active-clamp type converter on a single chip.

Note It is necessary to obtain license from Vicor Corporation before using the μ PC1909 in an active-clamp type circuit.

FEATURES

- 2 on-chip outputs; for Q and \bar{Q}
- Capable of directly driving a power MOS-FET
- Drive supply voltage range: 7 V to 24 V
- On-chip remote control circuit
- On-chip pulse-by-pulse overcurrent protection circuit
- On-chip overvoltage latch circuit

ORDERING INFORMATION

Part Number	Package
μ PC1909CX	16-pin plastic DIP (300 mils)
μ PC1909GS	16-pin plastic SOP (300 mils)

The information in this document is subject to change without notice. Before using this document, please confirm that this is the latest version.

Not all devices/types available in every country. Please check with local NEC representative for availability and additional information.

BLOCK DIAGRAM

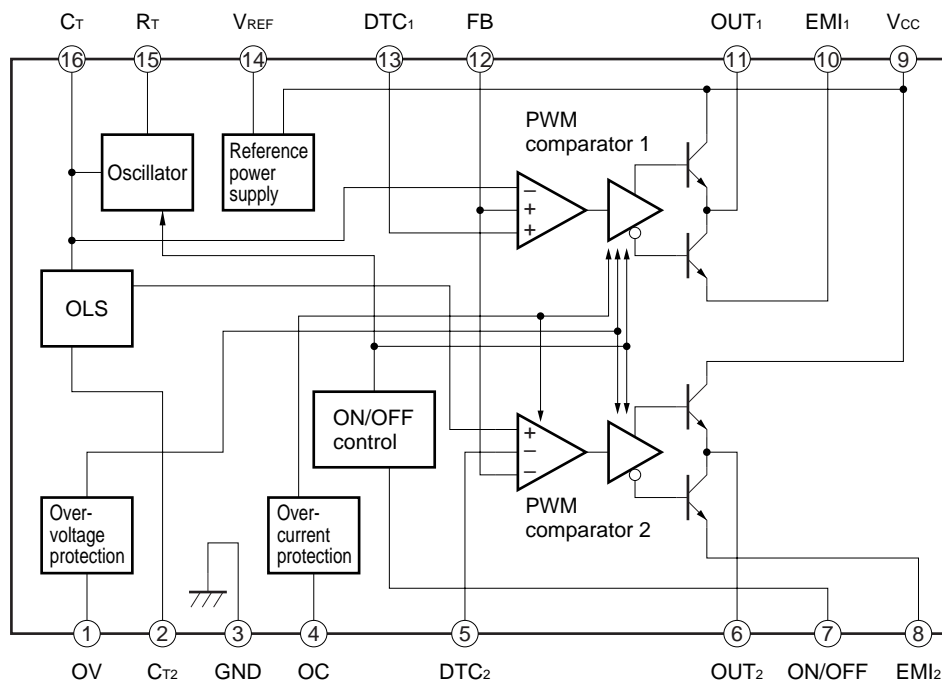

PIN CONFIGURATION (TOP VIEW)

16-pin plastic DIP (300 mils)
μPC1909CX

16-pin plastic SOP (300 mils)
μPC1909GS

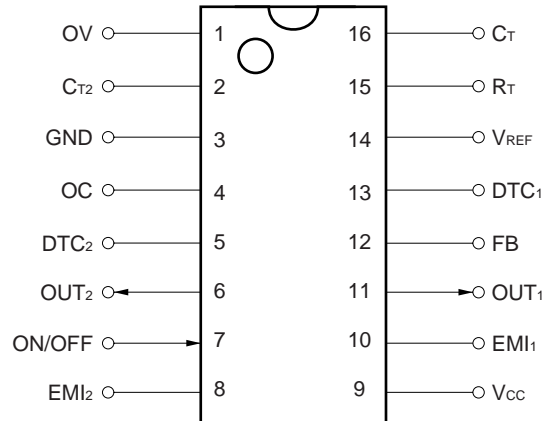

PIN FUNCTION LIST

Pin Number	Pin Name	Function	Pin Number	Pin Name	Function
1	OV	Overvoltage protection	9	V _{CC}	Power supply
2	C _{T2}	OLS shift setting	10	EMI ₁	OUT ₁ emitter
3	GND	Ground	11	OUT ₁	OUT ₁ output
4	OC	Overcurrent protection	12	FB	Feedback input
5	DTC ₂	OUT ₂ dead-time setting	13	DTC ₁	OUT ₁ dead-time setting
6	OUT ₂	OUT ₂ output	14	V _{REF}	Reference voltage output
7	ON/OFF	ON/OFF control	15	R _T	Timing resistance
8	EMI ₂	OUT ₂ emitter	16	C _T	Timing capacitance

ELECTRICAL SPECIFICATIONS

Absolute Maximum Ratings (Unless otherwise specified, T_A = 25°C)

Parameter	Symbol	μPC1909CX	μPC1909GS	Unit
Supply Voltage	V _{CC}	26		V
Output Current (DC, per output)	I _{C (DC)}	100		mA
Output Current (peak, per output)	I _{C (peak)}	1.2		A
Total Power Dissipation	P _T	1000	694	mW
Operating Ambient Temperature	T _A	-20 to +85		°C
Operating Junction Temperature	T _J	-20 to +150		°C
Storage Temperature	T _{stg}	-55 to +150		°C

Caution Product quality may suffer if the absolute maximum rating is exceeded even momentarily for any parameter. That is, the absolute maximum ratings are rated values at which the product is on the verge of suffering physical damage, and therefore the product must be used under conditions that ensure that the absolute maximum ratings are not exceeded.

Recommended Operating Conditions

Parameter	Symbol	MIN.	TYP.	MAX.	Unit
Supply Voltage	V _{CC}	7	10	24	V
Oscillation Frequency	f _{osc}	50	200	500	kHz
Output Load Capacitance	C _L		2200	3000	pF
Output Load Resistance	R _L	10			kΩ
Operating Junction Temperature	T _J	-20		+100	°C

Electrical Characteristics (Unless otherwise specified, T_A = 25°C, V_{CC} = 10 V, R_T = 10 kΩ, f_{osc} = 200 kHz)

Block	Parameter	Symbol	Conditions	MIN.	TYP.	MAX.	Unit
Total	Standby Current	I _{CC(SB)}	V _{CC} = 7 V		0.1		mA
	Circuit Current	I _{CC}	Without load	6	12	18	mA
Under-Voltage Lockout Circuit	Start-Up Threshold Voltage	V _{CC(L to H)}		8	9	10	V
	Operating Voltage Hysteresis Width	V _H		3	4	5	V
Reference Voltage	Output Voltage	V _{REF}	I _{REF} = 0 A	4.7	4.9	5.1	V
	Line Regulation	REG _{IN}	8 V ≤ V _{CC} ≤ 15 V, I _{REF} = 0 A		1	10	mV
	Load Regulation	REG _L	1 mA ≤ I _{REF} ≤ 4 mA		6	12	mV
	Output Voltage Temperature Coefficient	ΔV _{REF} /ΔT	-10°C ≤ T _A ≤ +85°C, I _{REF} = 0 A		400	(700)	μV/°C
	Short Circuit Current	I _{O short}	I _{REF} = 0 A		15		mA
Oscillation	Oscillation Frequency	f _{osc}		180	200	220	kHz
	Frequency Line Regulation	Δf/ΔV	8 V ≤ V _{CC} ≤ 15 V		1		%
	Frequency Temperature Coefficient	Δf/ΔT	-10°C ≤ T _A ≤ +85°C		2	(5)	%
PWM Comparator	Input Bias Current	I _{B(COMP1)}	V _{COMP1} = V _{REF}			10	μA
		I _{B(COMP2)}	V _{COMP2} = V _{REF}			10	μA
	Low-level Threshold Voltage	V _{TH(L)}			1.5		V
	High-level Threshold Voltage	V _{TH(H)}			3.5		V
	Dead-time Temperature Coefficient	ΔDT/ΔT	-10°C ≤ T _A ≤ +85°C, V _D = 0.46 V _{REF}		3		%
Output	Low-level Output Voltage	V _{OL}	I _{SINK} = 3 mA			0.5	V
	High-level Output Voltage	V _{OH}	I _{SOURCE} = 30 mA		V _{CC} - 1.6		V
	Rise Time	t _r	R _L = 15 Ω, C _L = 2200 pF		60		ns
	Fall Time	t _f	R _L = 15 Ω, C _L = 2200 pF		40		ns
Remote Control	Input Voltage at Output ON	V _{IN(ON)}		2.4	2.6	2.8	V
	Input Voltage at Output OFF	V _{IN(OFF)}		2.2	2.4	2.6	V
	Hysteresis Width	V _H		0.1	0.2	0.3	V
Overcurrent Latch	Overcurrent Threshold Voltage	V _{TH(OC)}		190	210	230	mV
	Input Bias Current	I _{B(OC)}	V _{CC} = 0 V		200		μA
	Delay to Output	t _{d(OC)}			150		ns
Overvoltage Latch	Overvoltage Threshold Voltage	V _{TH(OV)}		2	2.4	2.8	V
	Input Bias Current	I _{B(OV)}	V _{OV} = V _{REF}			4	μA
	OVL Reset Voltage	V _{R(OV)}			2		V
	Delay to Output	t _{d(OV)}			750		ns

Remark Values in parentheses () represent reference values.

TYPICAL CHARACTERISTICS CURVES (UNLESS OTHERWISE SPECIFIED, $T_A = 25^\circ\text{C}$, $V_{CC} = 10\text{ V}$, REFERENCE VALUES)

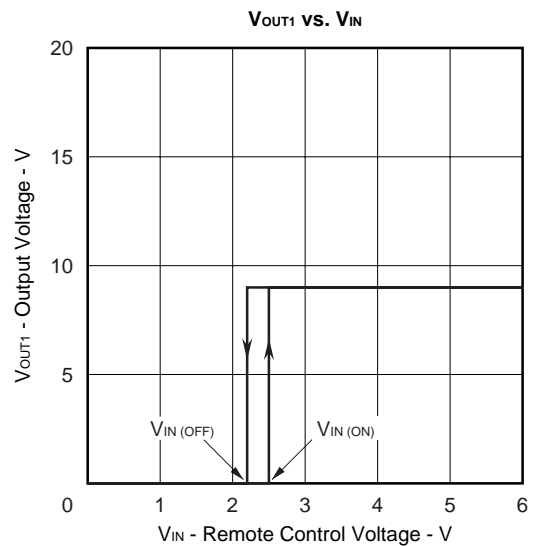
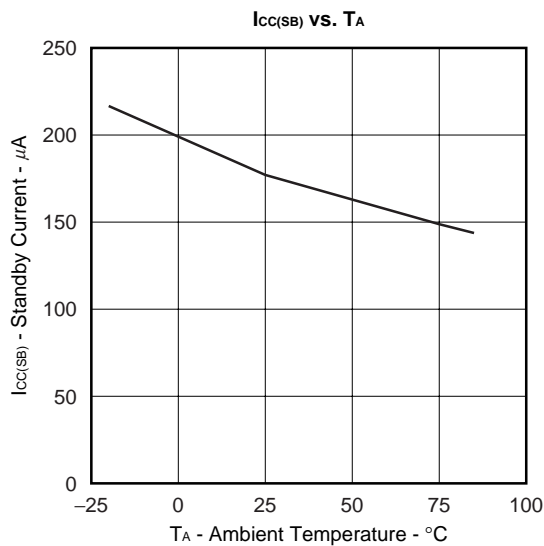
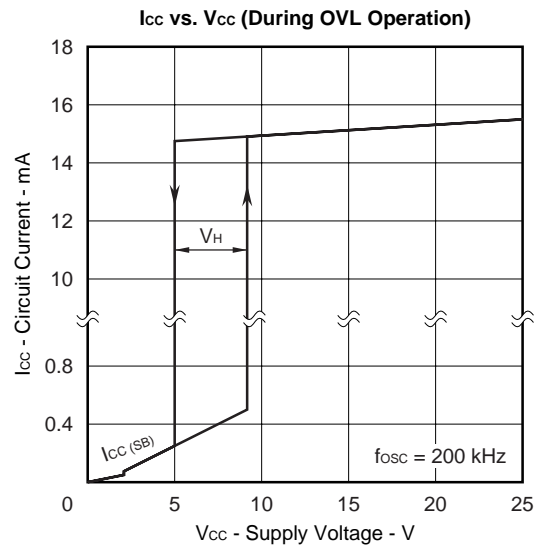
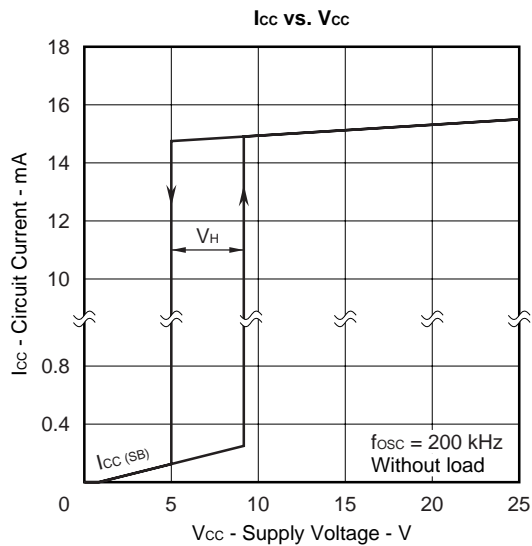
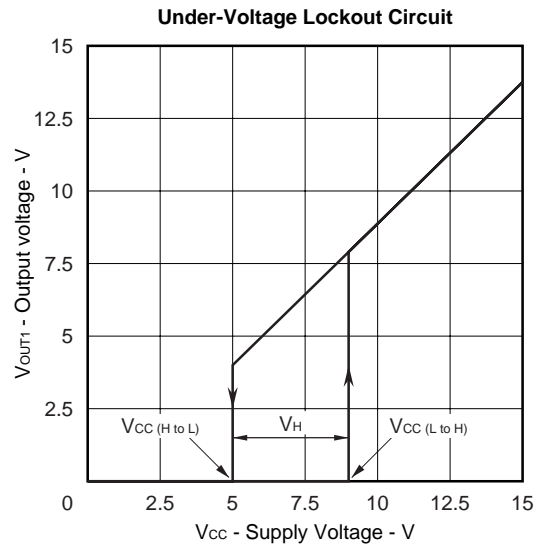
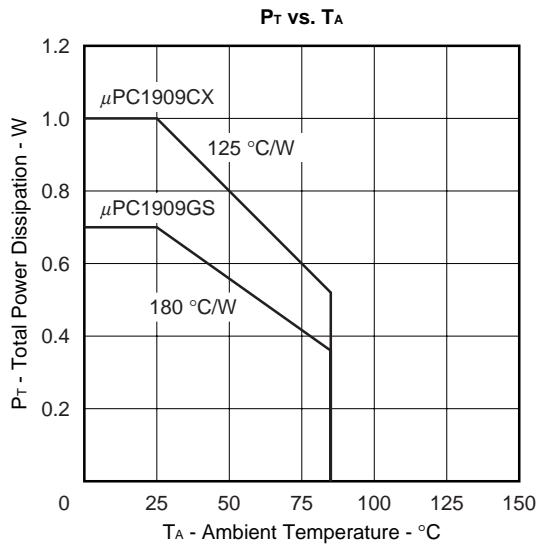

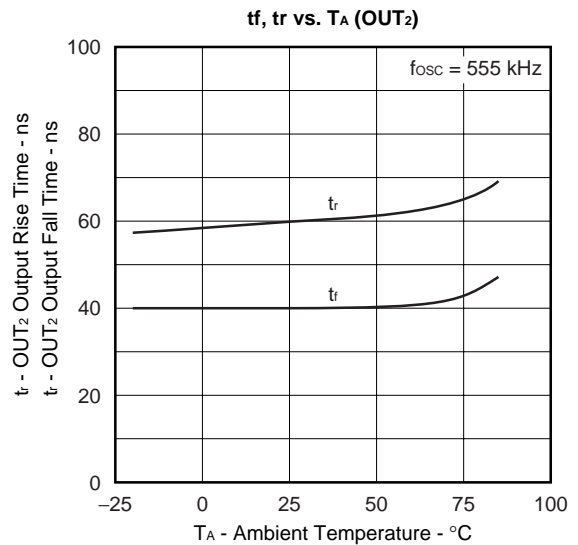
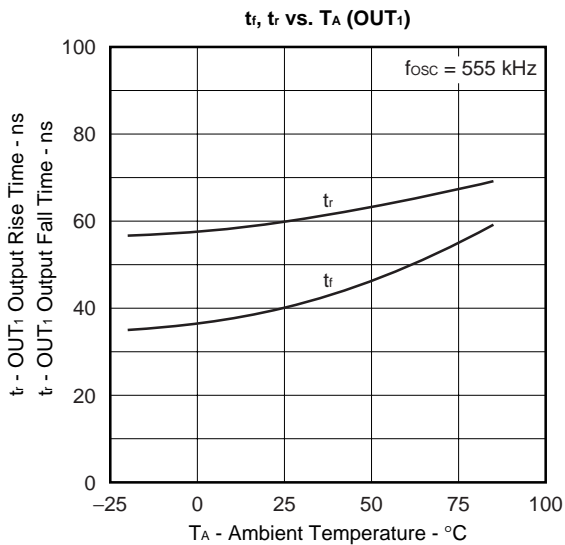
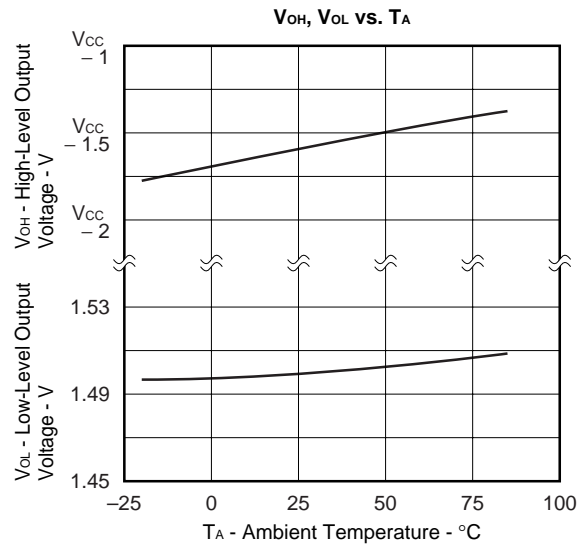
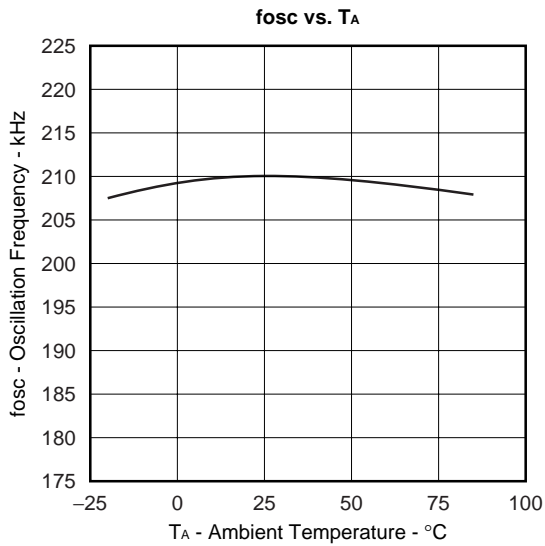
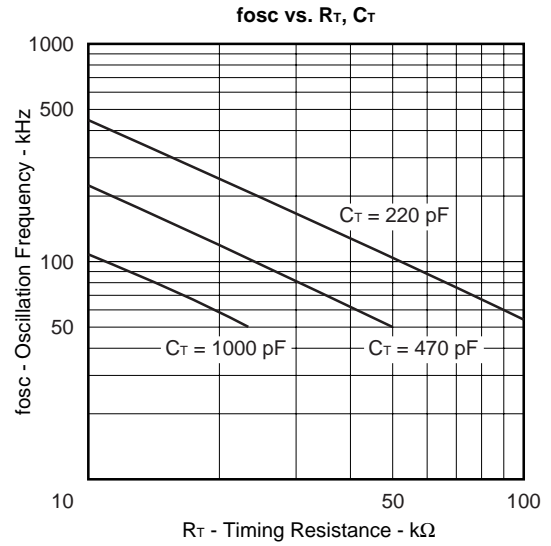
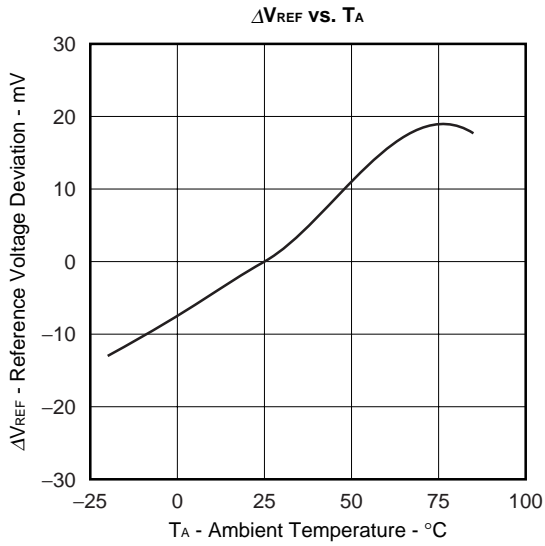

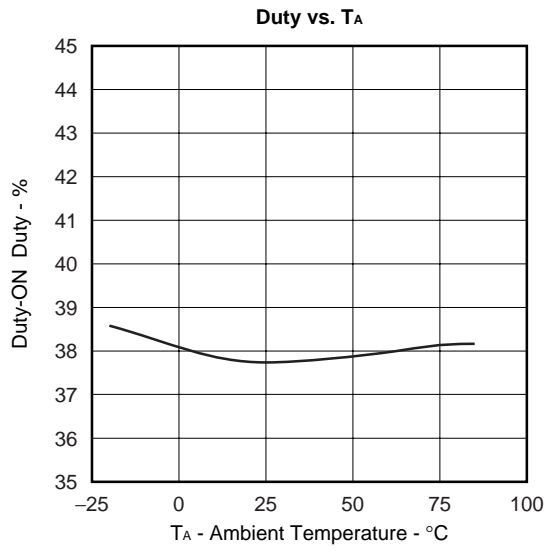

TIMING CHART

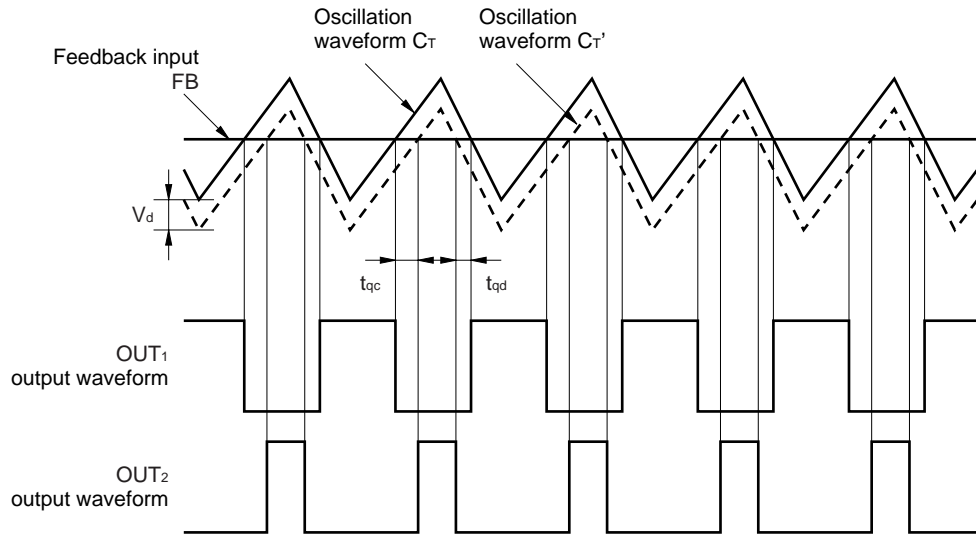

(1) Oscillation waveform (C_T)

This waveform is determined by the external capacitor connected to the C_T pin (pin 16) and the external resistor connected to the R_T pin (pin 15). It is usually a 1.5-V to 3.5-V triangle waveform (the rise and fall times are the same).

(2) Output waveform (OUT₁)

Whichever is the lower of the DTC₁ pin (pin 13) and FB pin (pin 12) voltages is compared with the triangle wave of the C_T pin (pin 16). The OUT₁ pin (pin 11) is high level while the triangle wave is low.

(3) Output waveform (OUT₂)

Whichever is the higher of the DTC₂ pin (pin 5) and FB pin (pin 12) voltages is compared with the level-shifted triangle wave (C_T'). The OUT₂ pin (pin 6) is high level while the level-shifted triangle wave is high.

(4) Triangle wave level shift

The triangle wave that controls OUT₂ is the original triangle wave of the C_T pin (pin 16) shifted to a lower potential via the level shift circuit (OLS). The amount of shift (V_d) can be adjusted using the resistor (R_{CT2}) connected between the C_{T2} pin (pin 2) and the V_{REF} pin.

The relationship between the shift amount (V_d) and the resistance value (kΩ) of the resistor R_{CT2} connected to the C_{T2} pin (pin 2) is as follows.

$$V_d = \frac{4.3}{R_{CT2}[k\Omega] + 10} \times 2 [V]$$

(5) Dead-time (t_{qc}, t_{qd}) adjustment

The dead time between the fall of OUT₁ and the rise of OUT₂ (t_{qc}) and the dead time between the fall of OUT₂ and the rise of OUT₁ (t_{qd}) is determined by the oscillation frequency and the amount of level shift of the triangle wave. Although usually t_{qc} = t_{qd}, if setting these independently, connect a suitable resistor between the C_T pin and the V_{REF} pin, as well as between the C_T pin and GND, and adjust the dead time by making the oscillation waveform asymmetrical.

PACKAGE DRAWINGS

16 PIN PLASTIC DIP (300 mil)

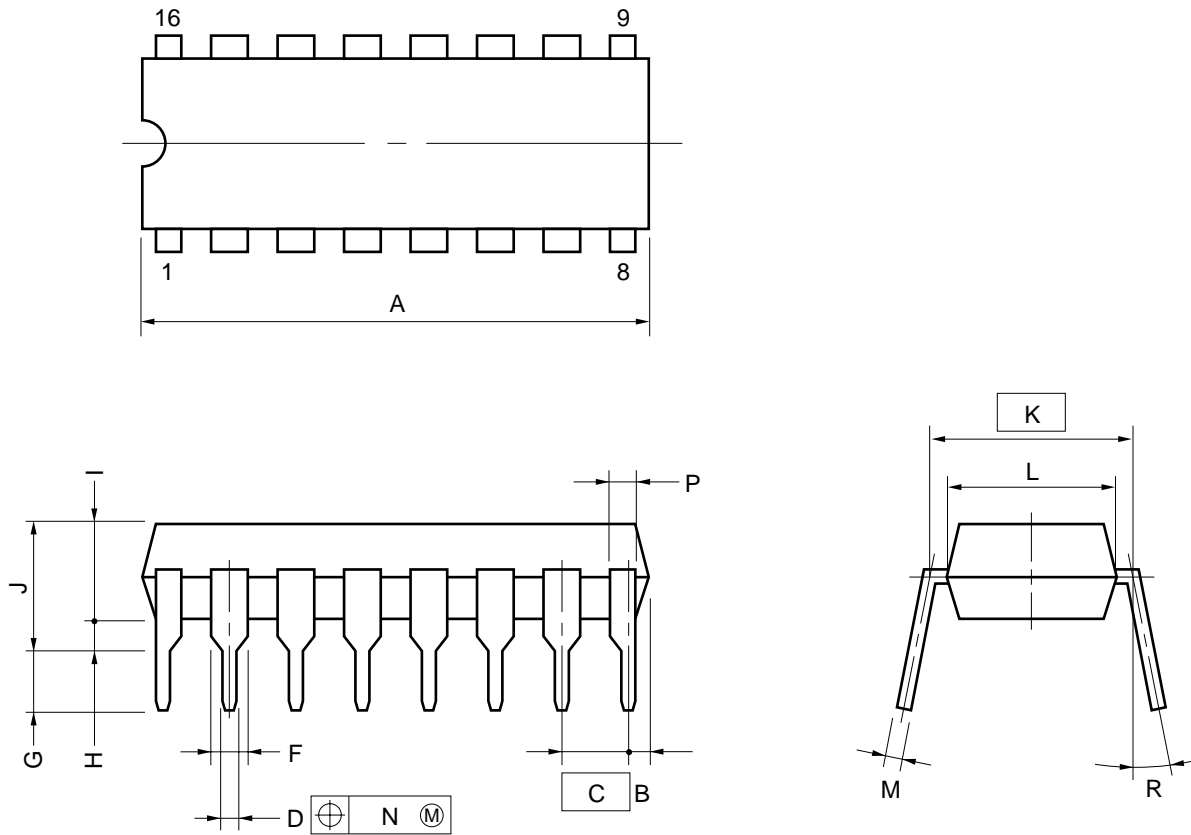

NOTES

- 1) Each lead centerline is located within 0.25 mm (0.01 inch) of its true position (T.P.) at maximum material condition.
- 2) Item "K" to center of leads when formed parallel.

ITEM	MILLIMETERS	INCHES
A	20.32 MAX.	0.800 MAX.
B	1.27 MAX.	0.050 MAX.
C	2.54 (T.P.)	0.100 (T.P.)
D	0.50±0.10	0.020 ^{+0.004} _{-0.005}
F	1.1 MIN.	0.043 MIN.
G	3.5±0.3	0.138±0.012
H	0.51 MIN.	0.020 MIN.
I	4.31 MAX.	0.170 MAX.
J	5.08 MAX.	0.200 MAX.
K	7.62 (T.P.)	0.300 (T.P.)
L	6.5	0.256
M	0.25 ^{+0.10} _{-0.05}	0.010 ^{+0.004} _{-0.003}
N	0.25	0.01
P	1.1 MIN.	0.043 MIN.
R	0~15°	0~15°

P16C-100-300B-1

16 PIN PLASTIC SOP (300 mil)

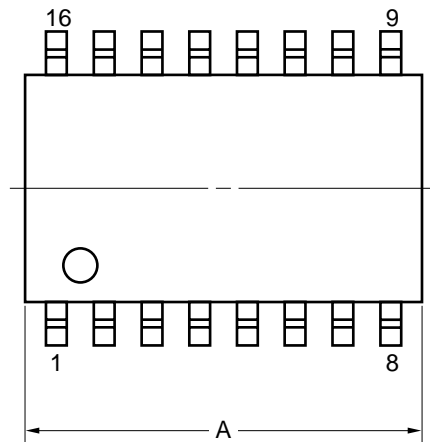

detail of lead end

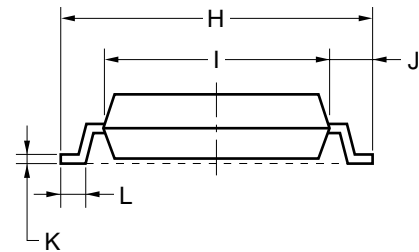
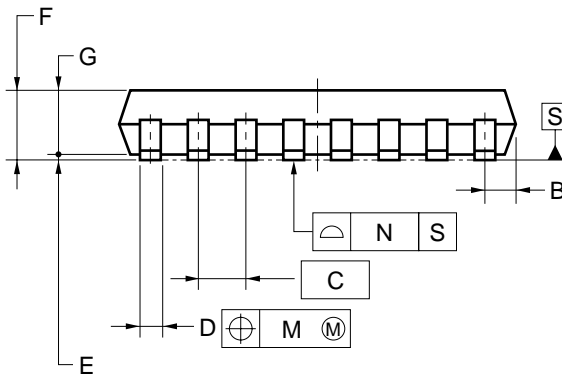
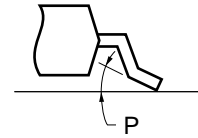

NOTE

Each lead centerline is located within 0.12 mm of its true position (T.P.) at maximum material condition.

ITEM	MILLIMETERS
A	10.2±0.2
B	0.78 MAX.
C	1.27 (T.P.)
D	0.42 ^{+0.08} _{-0.07}
E	0.1±0.1
F	1.65±0.15
G	1.55
H	7.7±0.3
I	5.6±0.2
J	1.1±0.2
K	0.22 ^{+0.08} _{-0.07}
L	0.6±0.2
M	0.12
N	0.10
P	3° ^{+7°} _{-3°}

P16GM-50-300B-5

RECOMMENDED SOLDERING CONDITIONS

The μPC1909 should be soldered and mounted under the following recommended conditions. For the details of the recommended soldering conditions, refer to the document **Semiconductor Device Mounting Technology Manual (C10535E)**. For soldering methods and conditions other than those recommended below, contact your NEC sales representative.

Insertion Type

μPC1909CX: 16-pin plastic DIP (300 mils)

Soldering Method	Soldering Conditions
Wave soldering (pins only)	Solder bath temperature: 260°C Max., Time: 10 seconds max.
Partial heating	Pin temperature: 300°C max., Time: 3 seconds max. (per pin)

Caution Apply wave soldering only to the pins and be careful not to bring solder into direct contact with the package.

Surface Mounting Type

μPC1909GS: 16-pin plastic SOP (300 mils)

Soldering Method	Soldering Conditions	Recommended Condition symbol
Infrared reflow	Package peak temperature: 235°C, Time: 30 seconds max. (at 210°C or higher), Count: Twice or less	IR35-00-2
VPS	Package peak temperature: 215°C, Time: 40 seconds max. (at 200°C or higher), Count: Twice or less	VP15-00-2
Wave soldering	Soldering bath temperature: 260°C or less, Time: 10 seconds max., Count: Once, Preheating temperature: 120°C MAX. (package surface temperature)	WS60-00-1

Caution Do not use different soldering methods together.

[MEMO]

[MEMO]

[MEMO]

- **The information in this document is subject to change without notice. Before using this document, please confirm that this is the latest version.**
 - No part of this document may be copied or reproduced in any form or by any means without the prior written consent of NEC Corporation. NEC Corporation assumes no responsibility for any errors which may appear in this document.
 - NEC Corporation does not assume any liability for infringement of patents, copyrights or other intellectual property rights of third parties by or arising from use of a device described herein or any other liability arising from use of such device. No license, either express, implied or otherwise, is granted under any patents, copyrights or other intellectual property rights of NEC Corporation or others.
 - Descriptions of circuits, software, and other related information in this document are provided for illustrative purposes in semiconductor product operation and application examples. The incorporation of these circuits, software, and information in the design of the customer's equipment shall be done under the full responsibility of the customer. NEC Corporation assumes no responsibility for any losses incurred by the customer or third parties arising from the use of these circuits, software, and information.
 - While NEC Corporation has been making continuous effort to enhance the reliability of its semiconductor devices, the possibility of defects cannot be eliminated entirely. To minimize risks of damage or injury to persons or property arising from a defect in an NEC semiconductor device, customers must incorporate sufficient safety measures in its design, such as redundancy, fire-containment, and anti-failure features.
 - NEC devices are classified into the following three quality grades:
"Standard", "Special", and "Specific". The Specific quality grade applies only to devices developed based on a customer designated "quality assurance program" for a specific application. The recommended applications of a device depend on its quality grade, as indicated below. Customers must check the quality grade of each device before using it in a particular application.
 - Standard: Computers, office equipment, communications equipment, test and measurement equipment, audio and visual equipment, home electronic appliances, machine tools, personal electronic equipment and industrial robots
 - Special: Transportation equipment (automobiles, trains, ships, etc.), traffic control systems, anti-disaster systems, anti-crime systems, safety equipment and medical equipment (not specifically designed for life support)
 - Specific: Aircraft, aerospace equipment, submersible repeaters, nuclear reactor control systems, life support systems or medical equipment for life support, etc.
- The quality grade of NEC devices is "Standard" unless otherwise specified in NEC's Data Sheets or Data Books. If customers intend to use NEC devices for applications other than those specified for Standard quality grade, they should contact an NEC sales representative in advance.