

### FEATURES

- **WIDE FREQUENCY RESPONSE:** 2.7 GHz
- **LOW VOLTAGE OPERATION:** 3 V NOMINAL (1.8 MIN)
- **LOW POWER CONSUMPTION:** 22.5 mW TYP
- **SUPER SMALL PACKAGE**
- **TAPE AND REEL PACKAGING OPTION AVAILABLE**

### DESCRIPTION

The UPC2745T is a Silicon Monolithic integrated circuit which is manufactured using the NESAT III process. The NESAT III process produces transistors with  $f_t$  approaching 20 GHz. This device is suitable as a buffer amplifier for cellular and cordless telephone applications. Operating on a 3 volt supply (1.8 volt minimum) this IC is ideally suited for hand-held, portable designs.

NEC's stringent quality assurance and test procedures ensure the highest reliability and performance.

### ELECTRICAL CHARACTERISTICS (T<sub>A</sub> = 25°C, Z<sub>L</sub> = Z<sub>S</sub> = 50 Ω)

**NOISE FIGURE AND GAIN vs. FREQUENCY**  
V<sub>CC</sub> = 3.0 V, I<sub>CC</sub> = 7.5 mA

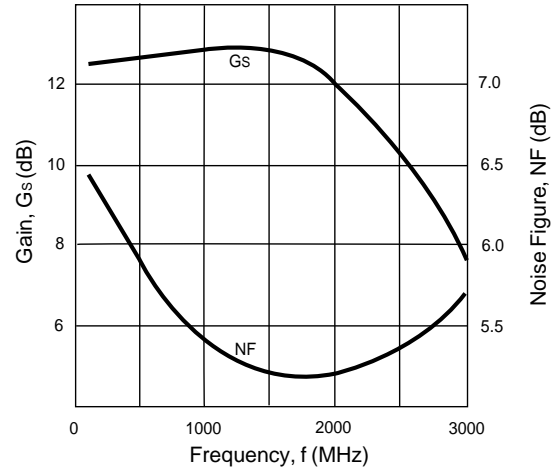

PART NUMBER PACKAGE OUTLINE			UPC2745T TO6		
SYMBOLS	PARAMETERS AND CONDITIONS	UNITS	MIN	TYP	MAX
I <sub>CC</sub>	Circuit Current (no signal) V <sub>CC</sub> = 3.0 V V <sub>CC</sub> = 1.8 V	mA mA	5.0	7.5 4.5	10.0
G <sub>s</sub>	Small Signal Gain, f = 500 MHz, V <sub>CC</sub> = 3.0 V f = 1000 MHz, V <sub>CC</sub> = 3.0 V f = 2000 MHz, V <sub>CC</sub> = 3.0 V f = 500 MHz, V <sub>CC</sub> = 1.8 V	dB dB dB dB	9	12 12 11 7	14
f <sub>u</sub> <sup>1</sup>	Upper Limit Operating Frequency, V <sub>CC</sub> = 3.0 V V <sub>CC</sub> = 1.8 V	GHz GHz	2.3	2.7 1.8	
P <sub>SAT</sub>	Saturated Output Power, f = 500 MHz, V <sub>CC</sub> = 3.0 V f = 1000 MHz, V <sub>CC</sub> = 3.0 V f = 2000 MHz, V <sub>CC</sub> = 3.0 V f = 500 MHz, V <sub>CC</sub> = 1.8 V	dBm dBm dBm dBm	-4	-1 -2.5 -3.5 -11	
NF	Noise Figure, f = 500 MHz, V <sub>CC</sub> = 3.0 V f = 1000 MHz, V <sub>CC</sub> = 3.0 V f = 2000 MHz, V <sub>CC</sub> = 3.0 V f = 500 MHz, V <sub>CC</sub> = 1.8 V	dB dB dB dB		6 5.5 5.7 8	7.5
RL <sub>IN</sub>	Input Return Loss, f = 500 MHz, V <sub>CC</sub> = 3.0 V f = 1000 MHz, V <sub>CC</sub> = 3.0 V f = 2000 MHz, V <sub>CC</sub> = 3.0 V f = 500 MHz, V <sub>CC</sub> = 1.8 V	dB dB dB dB	8	11 13 14 6.5	
RL <sub>OUT</sub>	Output Return Loss, f = 500 MHz, V <sub>CC</sub> = 3.0 V f = 1000 MHz, V <sub>CC</sub> = 3.0 V f = 2000 MHz, V <sub>CC</sub> = 3.0 V f = 500 MHz, V <sub>CC</sub> = 1.8 V	dB dB dB dB	2.5	5.5 6.5 8.5 6	
ISOL	Isolation, f = 500 MHz, V <sub>CC</sub> = 3.0 V f = 1000 MHz, V <sub>CC</sub> = 3.0 V f = 2000 MHz, V <sub>CC</sub> = 3.0 V f = 500 MHz, V <sub>CC</sub> = 1.8 V	dB dB dB dB	33	38 33 30 35	
OIP <sub>3</sub>	SSB Output Third Order Intercept, f <sub>1</sub> = 500 MHz, f <sub>2</sub> = 510 MHz, V <sub>CC</sub> = 3.0 V f <sub>1</sub> = 1000 MHz, f <sub>2</sub> = 1010 MHz, V <sub>CC</sub> = 3.0 V f <sub>1</sub> = 500 MHz, f <sub>2</sub> = 502 MHz, V <sub>CC</sub> = 1.8 V	dBm dBm dBm		7 5 -5	
R <sub>TH</sub> (J-A)	Thermal Resistance (Junction to Ambient) Free Air Mounted on a 50 x 50 x 1.6 mm epoxy glass PWB	°C/W °C/W			620 630

Note: 1. The gain at f<sub>u</sub> is 3 dB down from the gain at 100 MHz.

**ABSOLUTE MAXIMUM RATINGS<sup>1</sup>** (T<sub>A</sub> = 25°C)

SYMBOLS	PARAMETERS	UNITS	RATINGS
V <sub>CC</sub>	Supply Voltage	V	4.0
I <sub>CC</sub>	Total Supply Current	mA	16
P <sub>IN</sub>	Input Power	dBm	0
P <sub>T</sub>	Total Power Dissipation <sup>2</sup>	mW	280
T <sub>OP</sub>	Operating Temperature	°C	-40 to +85
T <sub>STG</sub>	Storage Temperature	°C	-55 to +150

Notes:

1. Operation in excess of any one of these parameters may result in permanent damage.
2. Mounted on a 50 x 50 x 1.6 mm epoxy glass PWB (T<sub>A</sub> = 85°C).

**RECOMMENDED OPERATING CONDITIONS**

SYMBOLS	PARAMETERS	UNITS	MIN	TYP	MAX
V <sub>CC</sub>	Supply Voltage	V	1.8	3	3.3
T <sub>OP</sub>	Operating Temperature	°C	-40	25	85

**TEST CIRCUIT**

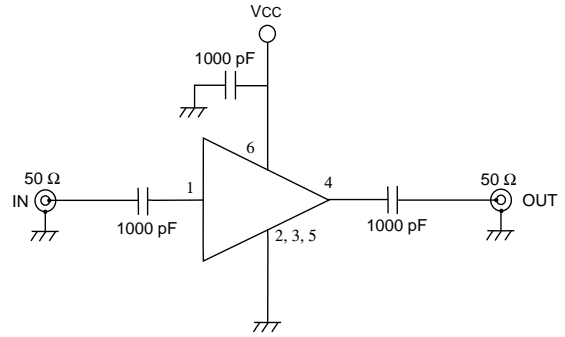

**TYPICAL PERFORMANCE CURVES** (T<sub>A</sub> = 25°C)

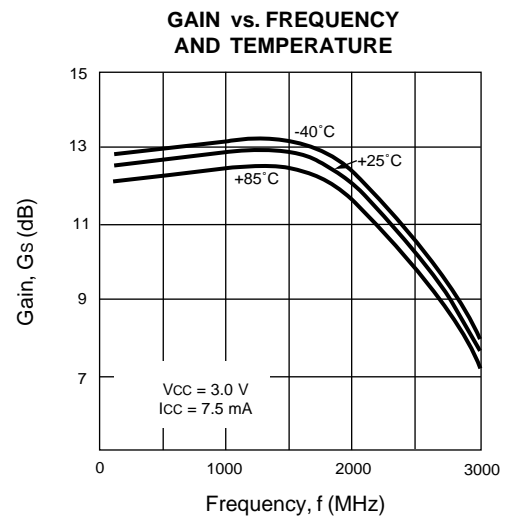
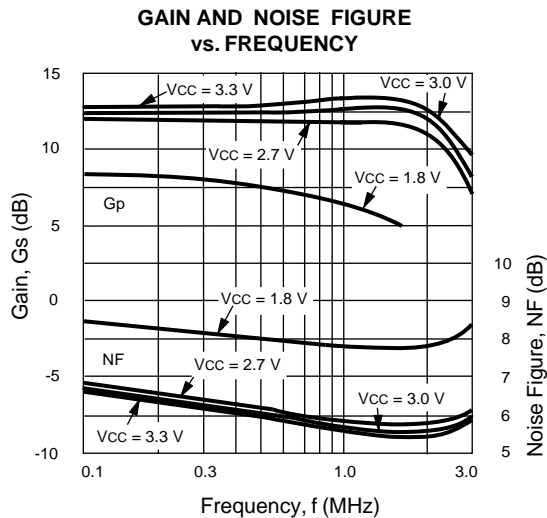
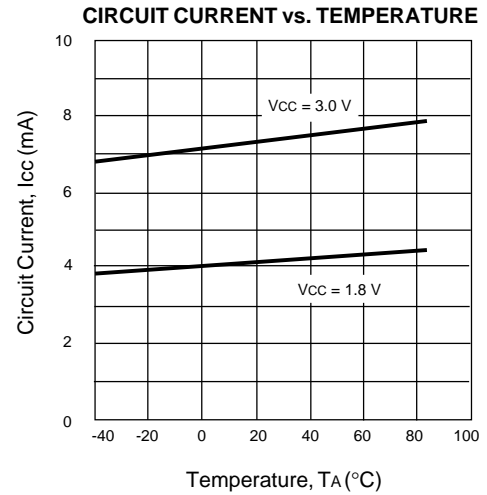
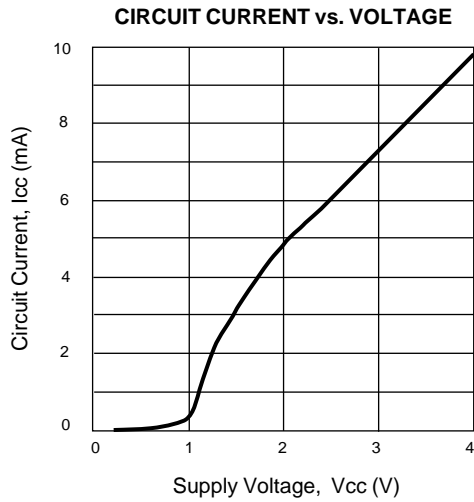

TYPICAL PERFORMANCE CURVES (TA = 25°C)

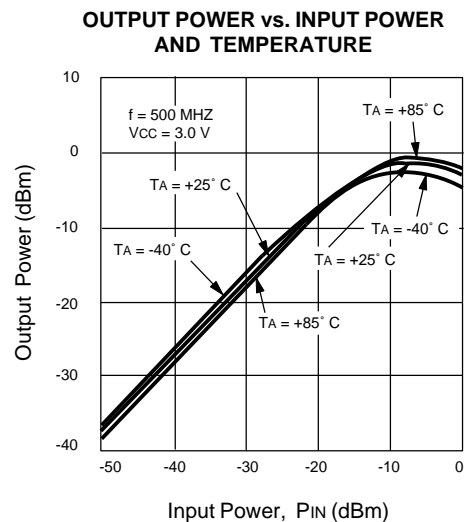
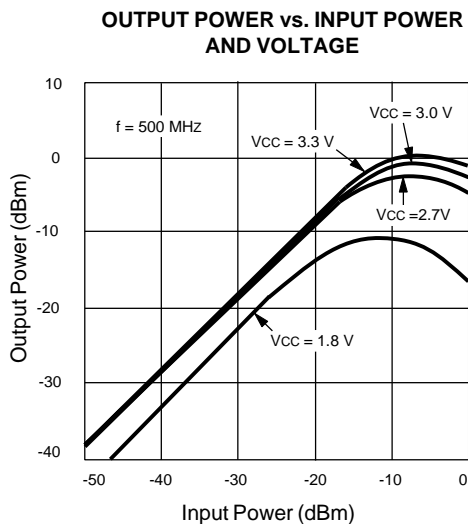
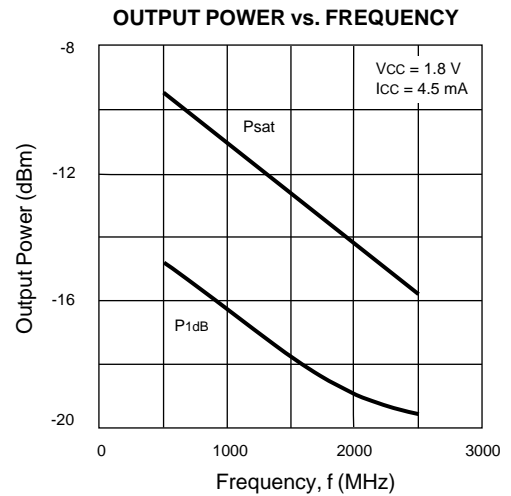
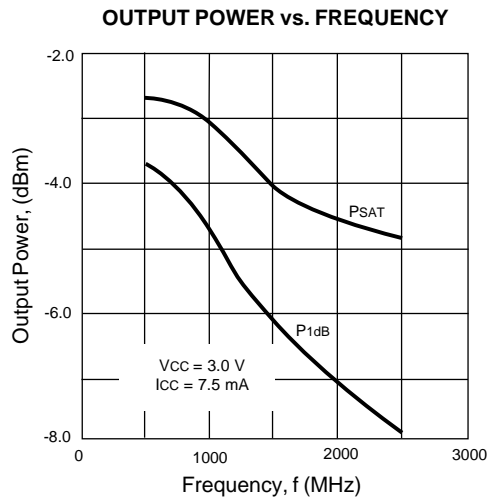
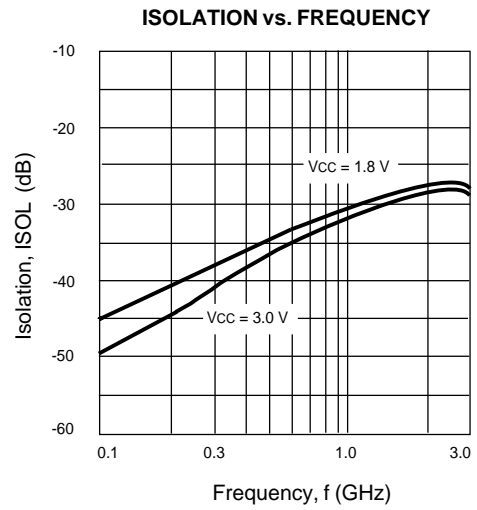
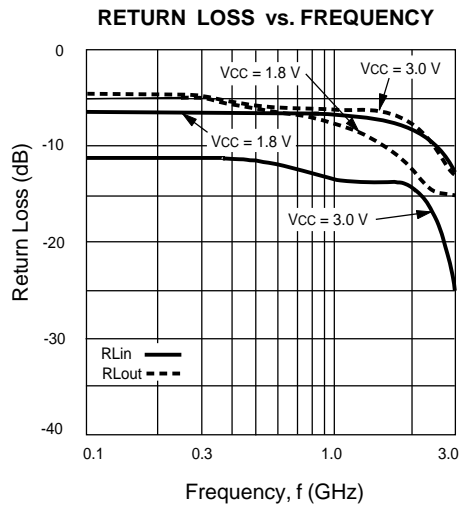

**TYPICAL SCATTERING PARAMETERS** (T<sub>A</sub> = 25°C)

V<sub>CC</sub> = 3.0 V, I<sub>CC</sub> = 7.5 mA

FREQUENCY (GHz)	S <sub>11</sub>		S <sub>21</sub>		S <sub>12</sub>		S <sub>22</sub>		K <sup>1</sup>	S <sub>21</sub> (dB)
	MAG	ANG	MAG	ANG	MAG	ANG	MAG	ANG		
0.1	0.267	-2.0	4.22	-5.2	0.003	92.2	0.611	-4.1	23.00	12.5
0.2	0.277	-5.5	4.23	-11.9	0.006	82.3	0.597	-9.2	11.71	12.5
0.3	0.278	-9.3	4.23	-18.7	0.009	74.0	0.584	-13.5	7.97	12.5
0.4	0.276	-13.8	4.24	-25.6	0.012	66.5	0.569	-17.1	6.12	12.5
0.5	0.276	-17.5	4.24	-32.0	0.014	60.1	0.557	-20.4	5.33	12.5
0.6	0.275	-20.8	4.26	-38.8	0.016	56.2	0.542	-23.4	4.75	12.6
0.7	0.274	-24.4	4.30	-45.8	0.017	54.6	0.530	-26.1	4.51	12.7
0.8	0.273	-26.9	4.31	-52.9	0.018	53.5	0.520	-29.1	4.31	12.7
0.9	0.272	-29.9	4.32	-60.1	0.020	51.0	0.511	-31.8	3.92	12.7
1.0	0.272	-31.4	4.34	-67.5	0.021	49.8	0.504	-34.3	3.74	12.8
1.2	0.270	-34.3	4.38	-82.0	0.023	46.4	0.493	-40.3	3.43	12.8
1.4	0.266	-37.3	4.37	-97.6	0.024	42.6	0.481	-46.5	3.35	12.8
1.6	0.258	-40.2	4.25	-113.8	0.024	42.0	0.465	-53.1	3.53	12.6
1.8	0.250	-43.1	4.08	-129.6	0.025	41.4	0.438	-58.6	3.66	12.2
2.0	0.242	-46.0	3.82	-145.2	0.026	40.9	0.401	-63.6	3.93	11.6
2.2	0.231	-48.7	3.50	-161.3	0.027	40.3	0.352	-68.6	4.35	10.9
2.4	0.215	-50.4	3.24	-174.5	0.027	39.8	0.309	-71.9	4.91	10.2
2.6	0.195	-51.4	2.97	172.6	0.027	39.2	0.259	-74.4	5.59	9.5
2.8	0.175	-52.3	2.69	160.3	0.026	38.7	0.215	-74.1	6.61	8.6
3.0	0.153	-51.3	2.41	150.5	0.026	38.2	0.165	-70.8	7.60	7.6

V<sub>CC</sub> = 1.8 V, I<sub>CC</sub> = 4.5 mA

FREQUENCY (GHz)	S <sub>11</sub>		S <sub>21</sub>		S <sub>12</sub>		S <sub>22</sub>		K <sup>1</sup>	S <sub>21</sub> (dB)
	MAG	ANG	MAG	ANG	MAG	ANG	MAG	ANG		
0.1	0.467	-1.4	2.47	-8.7	0.003	63.6	0.608	-5.5	33.13	7.9
0.2	0.483	-3.9	2.40	-19.2	0.007	62.0	0.596	-11.7	14.57	7.6
0.3	0.494	-7.6	2.34	-29.6	0.011	60.3	0.580	-17.2	9.60	7.4
0.4	0.498	-10.7	2.29	-39.0	0.015	58.7	0.557	-21.3	7.40	7.2
0.5	0.500	-14.9	2.22	-48.1	0.018	57.0	0.538	-25.9	6.51	6.9
0.6	0.503	-18.6	2.14	-56.9	0.021	55.4	0.511	-29.4	5.99	6.6
0.7	0.505	-22.5	2.08	-64.9	0.024	53.8	0.501	-33.8	5.44	6.4
0.8	0.507	-26.1	2.01	-73.5	0.026	52.1	0.480	-36.1	5.31	6.1
0.9	0.510	-30.2	1.94	-81.8	0.027	50.5	0.470	-40.4	5.34	5.8
1.0	0.512	-34.2	1.88	-88.2	0.028	48.8	0.446	-43.8	5.46	5.5
1.2	0.508	-41.3	1.79	-104.2	0.030	45.6	0.415	-49.3	5.57	5.1
1.4	0.498	-48.6	1.70	-120.4	0.031	42.3	0.390	-54.6	5.90	4.6
1.6	0.480	-55.4	1.61	-134.5	0.032	39.0	0.360	-58.7	6.36	4.1
1.8	0.463	-62.1	1.51	-147.3	0.032	35.7	0.326	-61.7	7.14	3.6
2.0	0.438	-69.0	1.43	-160.8	0.032	32.5	0.291	-63.3	7.98	3.1
2.2	0.396	-76.2	1.35	-177.2	0.032	29.2	0.260	-64.1	9.02	2.6
2.4	0.349	-81.5	1.27	174.1	0.033	25.9	0.234	-64.2	9.85	2.1
2.6	0.304	-87.7	1.21	162.9	0.032	22.6	0.205	-62.7	11.19	1.7
2.8	0.273	-93.6	1.15	152.5	0.030	19.3	0.179	-59.6	12.96	1.2
3.0	0.230	-96.7	1.09	144.7	0.029	16.1	0.160	-54.6	14.59	0.7

Note:

1. K factor Calculation:

$$K = \frac{1 + |\Delta|^2 - |S_{11}|^2 - |S_{22}|^2}{2 |S_{12} S_{21}|}, \Delta = S_{11} S_{22} - S_{21} S_{12}$$

**OUTLINE DIMENSIONS** (Units in mm)

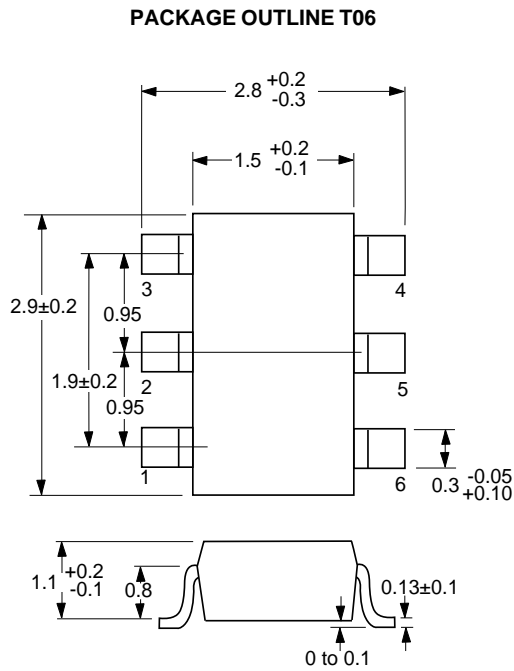

Note:  
All dimensions are typical unless otherwise specified.

**LEAD CONNECTIONS**

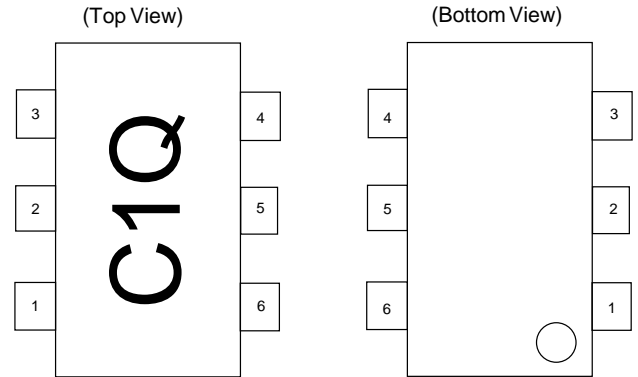

1. INPUT
2. GND
3. GND
4. OUTPUT
5. GND
6. Vcc

**EQUIVALENT CIRCUIT**

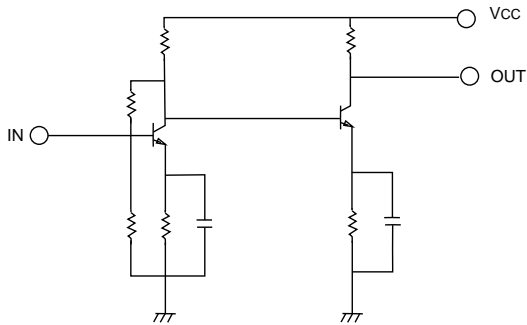

**RECOMMENDED P.C.B. LAYOUT** (Units in mm)

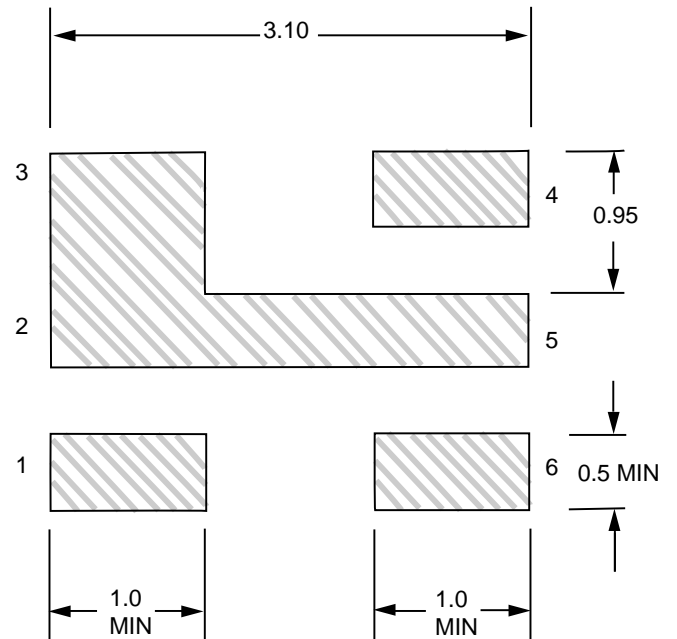

**ORDERING INFORMATION**

PART NUMBER	QTY
UPC2745T-E3	3K/Reel

Note:  
Embossed Tape, 8 mm wide.

EXCLUSIVE AGENT FOR **NEC Corporation** RF & MICROWAVE SEMICONDUCTOR PRODUCTS - U.S. & CANADA