

μPC3245TB

SiGe BiCMOS Integrated Circuit
Wideband Amplifier IC with 3-Step Gain Selection Function

R09DS0027EJ0100
Rev.1.00
Sep 26, 2011

DESCRIPTION

The μPC3245TB is a wideband amplifier IC mainly designed for SW Box and IF amplifier in DBS LNB application. This IC has 3-step gain selection function.

This IC is manufactured using our latest SiGe BiCMOS process that shows superior high frequency characteristics.

FEATURES

- Low voltage operation : $V_{CC} = 3.0$ to 3.6 V (3.3 V TYP.)
- Power gain
 - (High-gain mode) : $G_p = 20.5$ dB TYP. @ $f = 1.0$ GHz
: $G_p = 22$ dB TYP. @ $f = 2.2$ GHz
 - (Middle-gain mode) : $G_p = 14.5$ dB TYP. @ $f = 1.0$ GHz
: $G_p = 15.5$ dB TYP. @ $f = 2.2$ GHz
 - (Low-gain mode) : $G_p = 8.5$ dB TYP. @ $f = 1.0$ GHz
: $G_p = 9.5$ dB TYP. @ $f = 2.2$ GHz
- High linearity
 - (High-gain mode) : $P_{O(1\text{ dB})} = +10.5$ dBm TYP. @ $f = 1.0$ GHz
: $P_{O(1\text{ dB})} = +8.5$ dBm TYP. @ $f = 2.2$ GHz
 - (Middle-gain mode) : $P_{O(1\text{ dB})} = +11$ dBm TYP. @ $f = 1.0$ GHz
: $P_{O(1\text{ dB})} = +9.5$ dBm TYP. @ $f = 2.2$ GHz
 - (Low-gain mode) : $P_{O(1\text{ dB})} = +10.5$ dBm TYP. @ $f = 1.0$ GHz
: $P_{O(1\text{ dB})} = +9.5$ dBm TYP. @ $f = 2.2$ GHz

APPLICATIONS

- SW Box, IF amplifier in DBS LNB, other L-band Amplifier etc.

ORDERING INFORMATION

Part Number	Order Number	Package	Marking	Supplying Form
μPC3245TB-E3	μPC3245TB-E3-A	6-pin super minimold (Pb-Free)	C4E	<ul style="list-style-type: none"> • Embossed tape 8 mm wide • Pin 1, 2, 3 face the perforation side of the tape • Qty 3 kpcs/reel

Remark To order evaluation samples, please contact your nearby sales office.

Part number for sample order: μPC3245TB

CAUTION

Observe precautions when handling because these devices are sensitive to electrostatic discharge.

PIN CONNECTIONS, MARKING AND INTERNAL BLOCK DIAGRAM

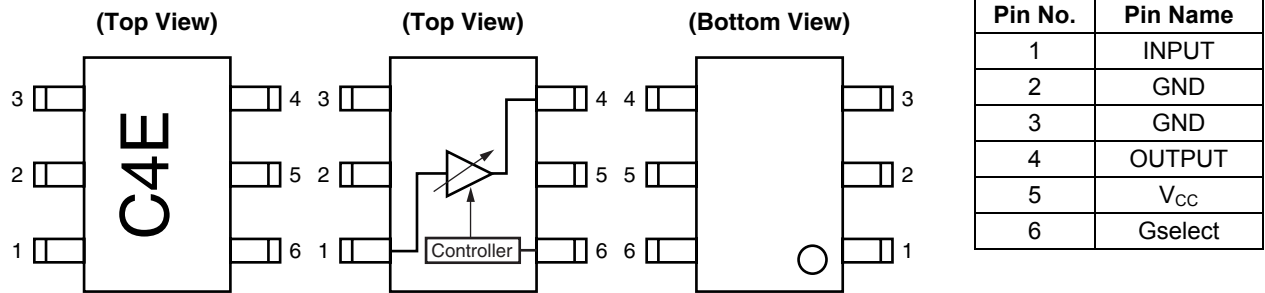

ABSOLUTE MAXIMUM RATINGS

Parameter	Symbol	Conditions	Ratings	Unit
Supply Voltage	V _{CC}	T _A = +25°C	4.0	V
Circuit Current	I _{CC}	T _A = +25°C	60	mA
Gain Selection Voltage	V _{Gselect}	T _A = +25°C	4.0	V
Power Dissipation	P _D	T _A = +85°C Note	166	mW
Operating Ambient Temperature	T _A		-40 to +85	°C
Storage Temperature	T _{stg}		-55 to +150	°C
Input Power	P _{in}	T _A = +25°C	+10	dBm

Note: Mounted on double-sided copper-clad 50 × 50 × 1.6 mm epoxy glass PWB

RECOMMENDED OPERATING RANGE

Parameter	Symbol	MIN.	TYP.	MAX.	Unit
Supply Voltage	V _{CC}	3.0	3.3	3.6	V
Gain Selection Voltage 1 (High-Gain Mode)	V _{Gselect1}	-0.2	0	0.2	V
Gain Selection Voltage 2 (Low-Gain Mode) Note	V _{Gselect2}	3.0	3.3	3.6	V
Operating Frequency	f	0.25	-	3	GHz
Operating Ambient Temperature	T _A	-40	+25	+85	°C

Note: V_{CC} - 0.2 V ≤ V_{Gselect2} ≤ V_{CC} + 0.2 V

ELECTRICAL CHARACTERISTICS 1 (HIGH-GAIN MODE)

(T_A = +25°C, V_{CC} = 3.3 V, Gselect = GND, Z_S = Z_L = 50 Ω, unless otherwise specified)

Parameter	Symbol	Test Conditions	MIN.	TYP.	MAX.	Unit
Circuit Current	I _{CC}	No input signal	22	27.5	33.5	mA
Power Gain 1	G _{p1}	f = 1.0 GHz, P _{in} = -30 dBm	18	20.5	23	dB
Power Gain 2	G _{p2}	f = 2.2 GHz, P _{in} = -30 dBm	19	22	25	dB
Gain 1 dB Compression Output Power 1	P _{O(1 dB)1}	f = 1.0 GHz	+7.5	+10.5	-	dBm
Gain 1 dB Compression Output Power 2	P _{O(1 dB)2}	f = 2.2 GHz	+5.5	+8.5	-	dBm
Input Return Loss 1	RL _{in1}	f = 1.0 GHz, P _{in} = -30 dBm	7	10.5	-	dB
Input Return Loss 2	RL _{in2}	f = 2.2 GHz, P _{in} = -30 dBm	10	17	-	dB
Output Return Loss 1	RL _{out1}	f = 1.0 GHz, P _{in} = -30 dBm	10	32	-	dB
Output Return Loss 2	RL _{out2}	f = 2.2 GHz, P _{in} = -30 dBm	7	11.5	-	dB

ELECTRICAL CHARACTERISTICS 2 (MIDDLE-GAIN MODE)

($T_A = +25^\circ\text{C}$, $V_{CC} = 3.3\text{ V}$, $G_{\text{select}} = \text{Open}$, $Z_S = Z_L = 50\ \Omega$, unless otherwise specified)

Parameter	Symbol	Test Conditions	MIN.	TYP.	MAX.	Unit
Circuit Current	I_{CC}	No input signal	22	27.5	33.5	mA
Power Gain 1	G_{P1}	$f = 1.0\text{ GHz}$, $P_{in} = -30\text{ dBm}$	12.5	14.5	16.5	dB
Power Gain 2	G_{P2}	$f = 2.2\text{ GHz}$, $P_{in} = -30\text{ dBm}$	13	15.5	18	dB
Gain 1 dB Compression Output Power 1	$P_{O(1\text{ dB})1}$	$f = 1.0\text{ GHz}$	+8	+11	–	dBm
Gain 1 dB Compression Output Power 2	$P_{O(1\text{ dB})2}$	$f = 2.2\text{ GHz}$	+6.5	+9.5	–	dBm
Input Return Loss 1	RL_{in1}	$f = 1.0\text{ GHz}$, $P_{in} = -30\text{ dBm}$	10	16.5	–	dB
Input Return Loss 2	RL_{in2}	$f = 2.2\text{ GHz}$, $P_{in} = -30\text{ dBm}$	7	12	–	dB
Output Return Loss 1	RL_{out1}	$f = 1.0\text{ GHz}$, $P_{in} = -30\text{ dBm}$	10	18.5	–	dB
Output Return Loss 2	RL_{out2}	$f = 2.2\text{ GHz}$, $P_{in} = -30\text{ dBm}$	7	15.5	–	dB

ELECTRICAL CHARACTERISTICS 3 (LOW-GAIN MODE)

($T_A = +25^\circ\text{C}$, $V_{CC} = 3.3\text{ V}$, $G_{\text{select}} = V_{CC}$, $Z_S = Z_L = 50\ \Omega$, unless otherwise specified)

Parameter	Symbol	Test Conditions	MIN.	TYP.	MAX.	Unit
Circuit Current	I_{CC}	No input signal	24	29	35	mA
Power Gain 1	G_{P1}	$f = 1.0\text{ GHz}$, $P_{in} = -30\text{ dBm}$	6.5	8.5	10.5	dB
Power Gain 2	G_{P2}	$f = 2.2\text{ GHz}$, $P_{in} = -30\text{ dBm}$	7	9.5	12	dB
Gain 1 dB Compression Output Power 1	$P_{O(1\text{ dB})1}$	$f = 1.0\text{ GHz}$	+7.5	+10.5	–	dBm
Gain 1 dB Compression Output Power 2	$P_{O(1\text{ dB})2}$	$f = 2.2\text{ GHz}$	+6.5	+9.5	–	dBm
Input Return Loss 1	RL_{in1}	$f = 1.0\text{ GHz}$, $P_{in} = -30\text{ dBm}$	10	19	–	dB
Input Return Loss 2	RL_{in2}	$f = 2.2\text{ GHz}$, $P_{in} = -30\text{ dBm}$	7	15.5	–	dB
Output Return Loss 1	RL_{out1}	$f = 1.0\text{ GHz}$, $P_{in} = -30\text{ dBm}$	10	24	–	dB
Output Return Loss 2	RL_{out2}	$f = 2.2\text{ GHz}$, $P_{in} = -30\text{ dBm}$	10	18	–	dB

STANDARD CHARACTERISTICS FOR REFERENCE 1 (HIGH-GAIN MODE)

($T_A = +25^\circ\text{C}$, $V_{CC} = 3.3\text{ V}$, $G_{\text{select}} = \text{GND}$, $Z_S = Z_L = 50\ \Omega$, unless otherwise specified)

Parameter	Symbol	Test Conditions	Reference Value	Unit
Power Gain 3	G_{P3}	$f = 0.25\text{ GHz}$, $P_{in} = -30\text{ dBm}$	18	dB
Power Gain 4	G_{P4}	$f = 2.6\text{ GHz}$, $P_{in} = -30\text{ dBm}$	20.5	dB
Power Gain 5	G_{P5}	$f = 3.0\text{ GHz}$, $P_{in} = -30\text{ dBm}$	18	dB
Gain Flatness	ΔG_P	$f = 1.0\text{ GHz to } 2.2\text{ GHz}$, $P_{in} = -30\text{ dBm}$	1.5	dB
Isolation 1	ISL1	$f = 1.0\text{ GHz}$, $P_{in} = -30\text{ dBm}$	31	dB
Isolation 2	ISL2	$f = 2.2\text{ GHz}$, $P_{in} = -30\text{ dBm}$	30	dB
Noise Figure 1	NF1	$f = 1.0\text{ GHz}$	4.0	dB
Noise Figure 2	NF2	$f = 2.2\text{ GHz}$	4.0	dB
Output 3rd Order Intercept Point 1	$OIP_3\ 1$	$f_1 = 1\ 000\text{ MHz}$, $f_2 = 1\ 001\text{ MHz}$	+22	dBm
Output 3rd Order Intercept Point 2	$OIP_3\ 2$	$f_1 = 2\ 200\text{ MHz}$, $f_2 = 2\ 201\text{ MHz}$	+20	dBm
2nd Order Intermodulation Distortion	IM_2	$f_1 = 1\ 000\text{ MHz}$, $f_2 = 1\ 001\text{ MHz}$, $P_{out} = -5\text{ dBm/ tone}$	42	dBc
2nd Harmonic	$2f_0$	$f_0 = 1.0\text{ GHz}$, $P_{out} = -15\text{ dBm}$	53	dBc

STANDARD CHARACTERISTICS FOR REFERENCE 2 (MIDDLE-GAIN MODE)
(T_A = +25°C, V_{CC} = 3.3 V, Gselect = Open, Z_S = Z_L = 50 Ω, unless otherwise specified)

Parameter	Symbol	Test Conditions	Reference Value	Unit
Power Gain 3	G _{p3}	f = 0.25 GHz, P _{in} = -30 dBm	14.5	dB
Power Gain 4	G _{p4}	f = 2.6 GHz, P _{in} = -30 dBm	15.5	dB
Power Gain 5	G _{p5}	f = 3.0 GHz, P _{in} = -30 dBm	14.5	dB
Gain Flatness	ΔG _p	f = 1.0 GHz to 2.2 GHz, P _{in} = -30 dBm	1.0	dB
Isolation 1	ISL1	f = 1.0 GHz, P _{in} = -30 dBm	24.5	dB
Isolation 2	ISL2	f = 2.2 GHz, P _{in} = -30 dBm	24.5	dB
Noise Figure 1	NF1	f = 1.0 GHz	6.0	dB
Noise Figure 2	NF2	f = 2.2 GHz	6.5	dB
Output 3rd Order Intercept Point 1	OIP ₃ 1	f1 = 1 000 MHz, f2 = 1 001 MHz	+24	dBm
Output 3rd Order Intercept Point 2	OIP ₃ 2	f1 = 2 200 MHz, f2 = 2 201 MHz	+21	dBm
2nd Order Intermodulation Distortion	IM ₂	f1 = 1 000 MHz, f2 = 1 001 MHz, P _{out} = -5 dBm/tone	49	dBc
2nd Harmonic	2f ₀	f0 = 1.0 GHz, P _{out} = -15 dBm	62	dBc

STANDARD CHARACTERISTICS FOR REFERENCE 3 (LOW-GAIN MODE)
(T_A = +25°C, V_{CC} = 3.3 V, Gselect = V_{CC}, Z_S = Z_L = 50 Ω, unless otherwise specified)

Parameter	Symbol	Test Conditions	Reference Value	Unit
Power Gain 3	G _{p3}	f = 0.25 GHz, P _{in} = -30 dBm	8	dB
Power Gain 4	G _{p4}	f = 2.6 GHz, P _{in} = -30 dBm	10	dB
Power Gain 5	G _{p5}	f = 3.0 GHz, P _{in} = -30 dBm	10	dB
Gain Flatness	ΔG _p	f = 1.0 GHz to 2.2 GHz, P _{in} = -30 dBm	1.0	dB
Isolation 1	ISL1	f = 1.0 GHz, P _{in} = -30 dBm	21	dB
Isolation 2	ISL2	f = 2.2 GHz, P _{in} = -30 dBm	24	dB
Noise Figure 1	NF1	f = 1.0 GHz	9.0	dB
Noise Figure 2	NF2	f = 2.2 GHz	9.0	dB
Output 3rd Order Intercept Point 1	OIP ₃ 1	f1 = 1 000 MHz, f2 = 1 001 MHz	+23	dBm
Output 3rd Order Intercept Point 2	OIP ₃ 2	f1 = 2 200 MHz, f2 = 2 201 MHz	+21	dBm
2nd Order Intermodulation Distortion	IM ₂	f1 = 1 000 MHz, f2 = 1 001 MHz, P _{out} = -5 dBm/tone	50	dBc
2nd Harmonic	2f ₀	f0 = 1.0 GHz, P _{out} = -15 dBm	64	dBc

TEST CIRCUIT

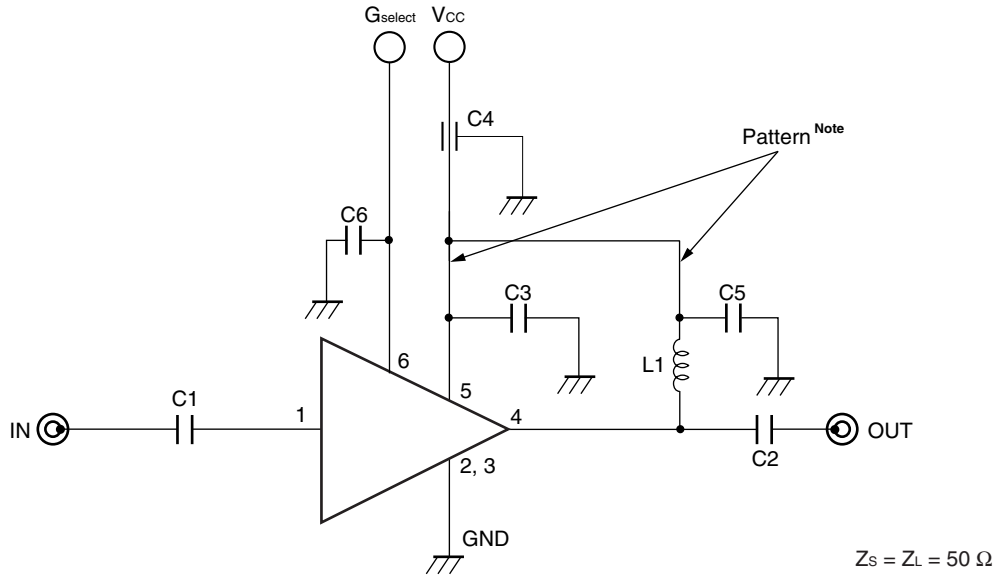

Note: The power supply to 4 pin and 5 pin is separated and supplied by the pattern.

The application circuits and their parameters are for reference only and are not intended for use in actual design-ins.

Gselect PIN CONNECTION

Gselect	Mode
GND	High-Gain Mode
OPEN	Middle-Gain Mode
V _{CC}	Low-Gain Mode

COMPONENTS LIST

Symbol	Type	Value	Unit
L1	Chip Inductor	47	nH
C1, C2	Chip Capacitor	100	pF
C3	Chip Capacitor	1 000	pF
C4	Feed-through Capacitor	1 000	pF
C5, C6	Chip Capacitor	1 000	pF

TYPICAL CHARACTERISTICS 1 (HIGH-GAIN MODE)

($T_A = +25^\circ\text{C}$, $V_{CC} = 3.3\text{ V}$, $G_{\text{select}} = \text{GND}$, $Z_S = Z_L = 50\ \Omega$, unless otherwise specified)

CIRCUIT CURRENT vs. SUPPLY VOLTAGE

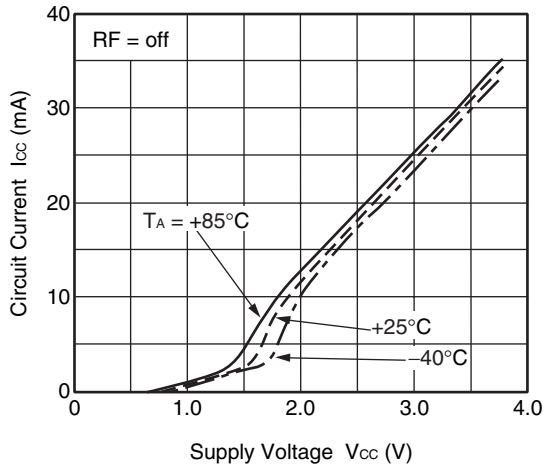

CIRCUIT CURRENT vs. OPERATING AMBIENT TEMPERATURE

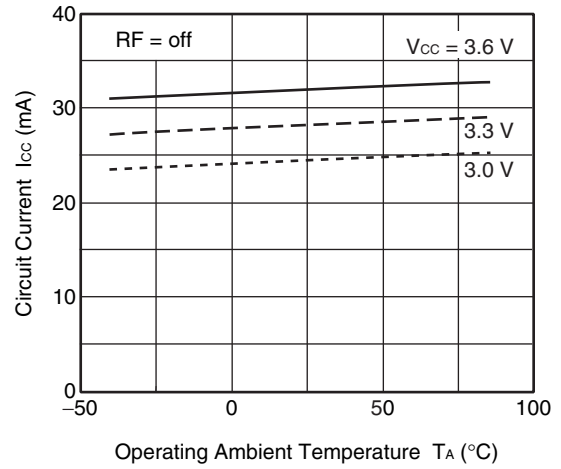

POWER GAIN vs. FREQUENCY

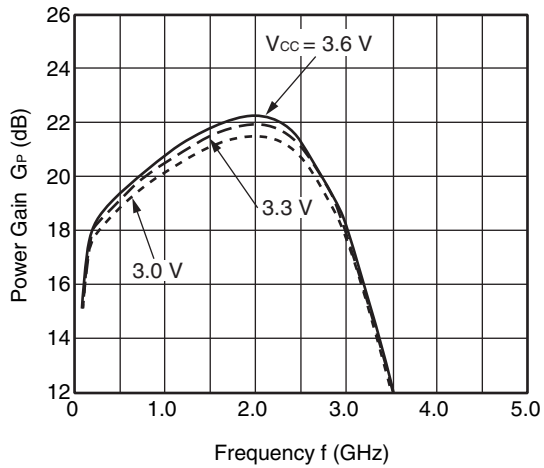

POWER GAIN vs. FREQUENCY

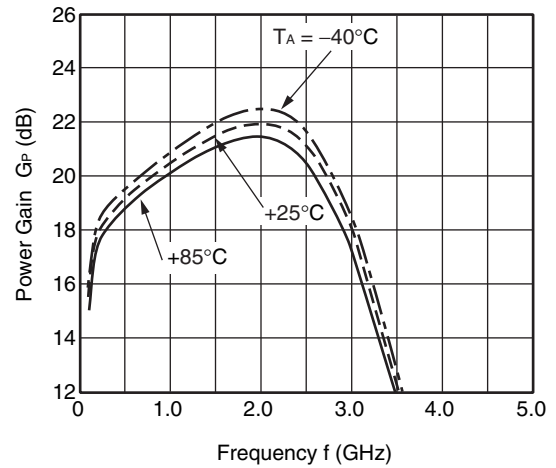

INPUT RETURN LOSS vs. FREQUENCY

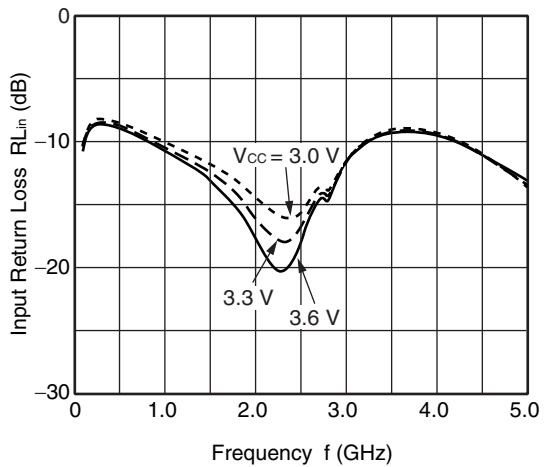

INPUT RETURN LOSS vs. FREQUENCY

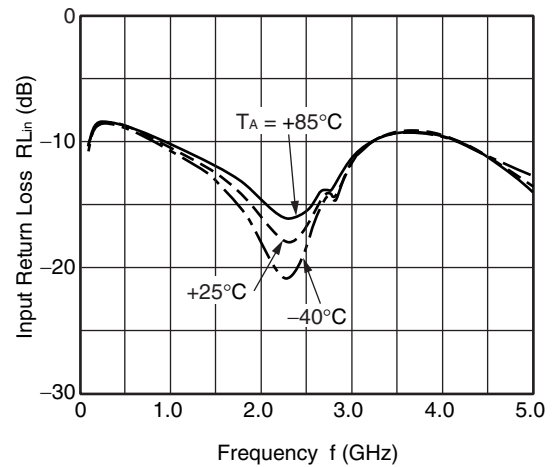

Remark The graphs indicate nominal characteristics.

OUTPUT RETURN LOSS vs. FREQUENCY

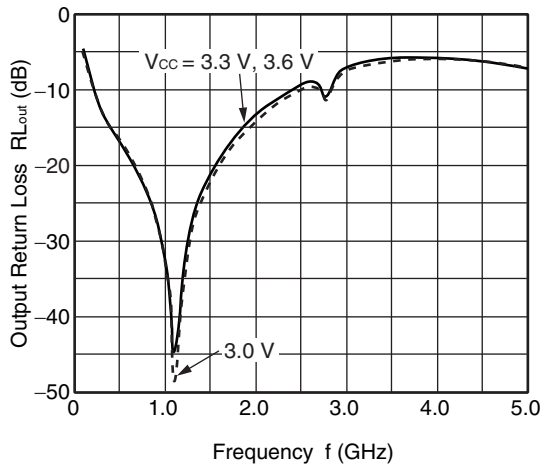

OUTPUT RETURN LOSS vs. FREQUENCY

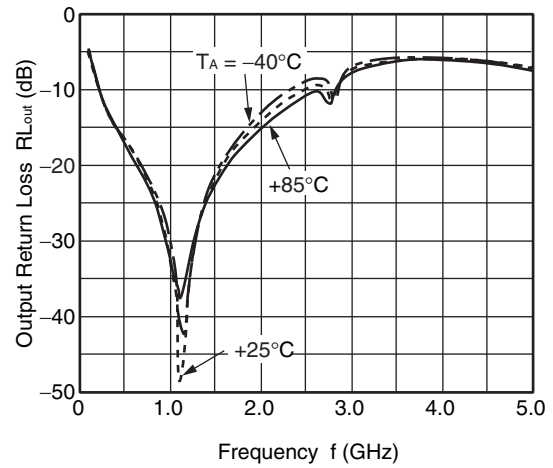

ISOLATION vs. FREQUENCY

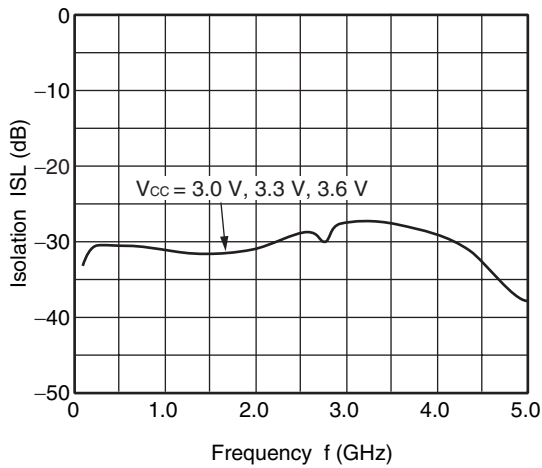

ISOLATION vs. FREQUENCY

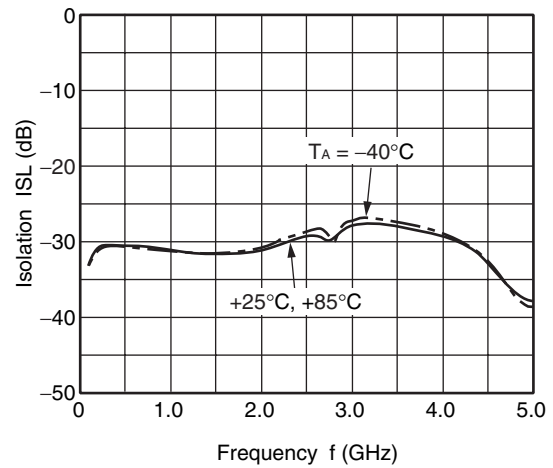

K FACTOR vs. FREQUENCY

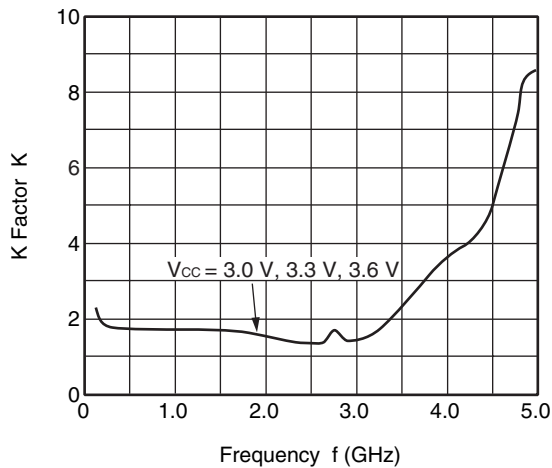

K FACTOR vs. FREQUENCY

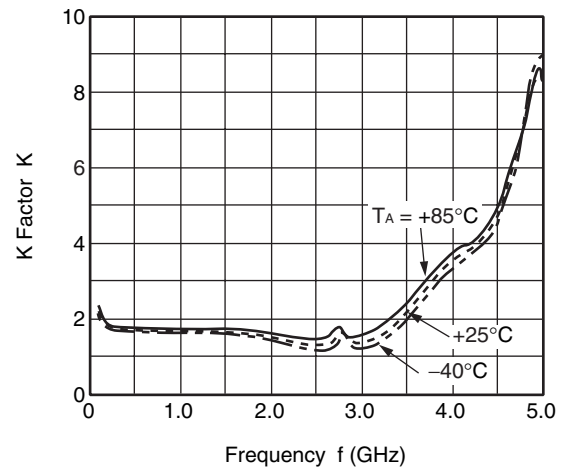

Remark The graphs indicate nominal characteristics.

NOISE FIGURE vs. FREQUENCY

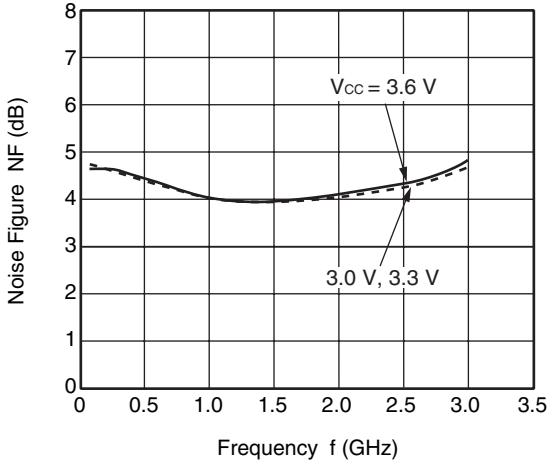

NOISE FIGURE vs. FREQUENCY

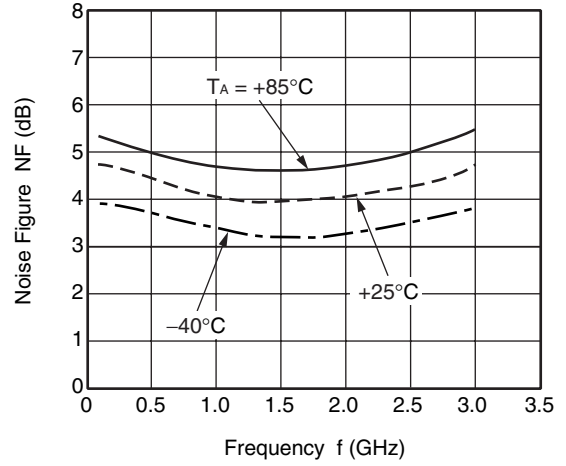

OUTPUT POWER vs. INPUT POWER

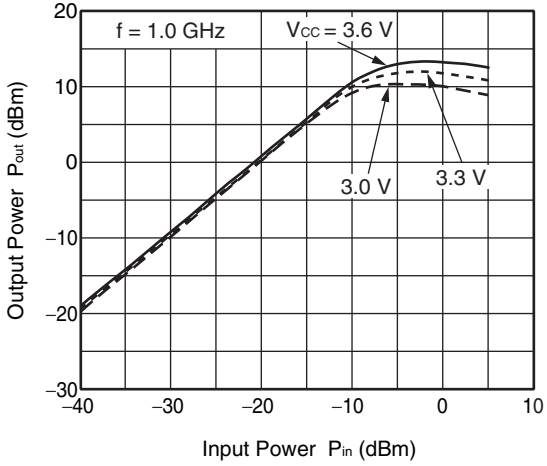

OUTPUT POWER vs. INPUT POWER

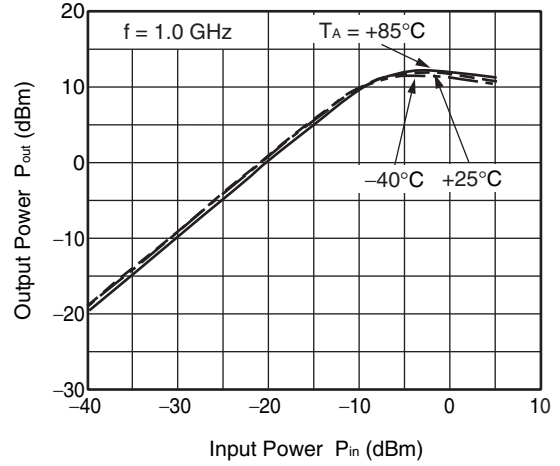

OUTPUT POWER vs. INPUT POWER

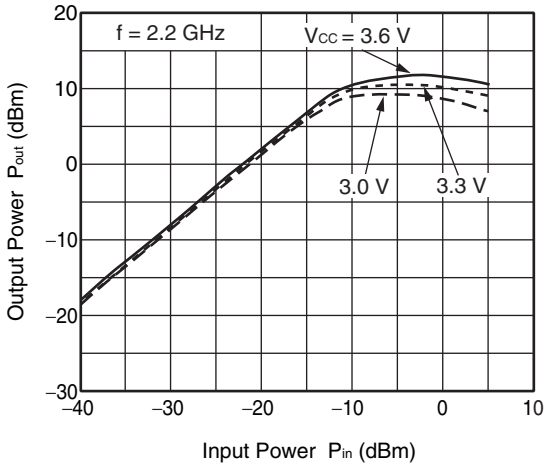

OUTPUT POWER vs. INPUT POWER

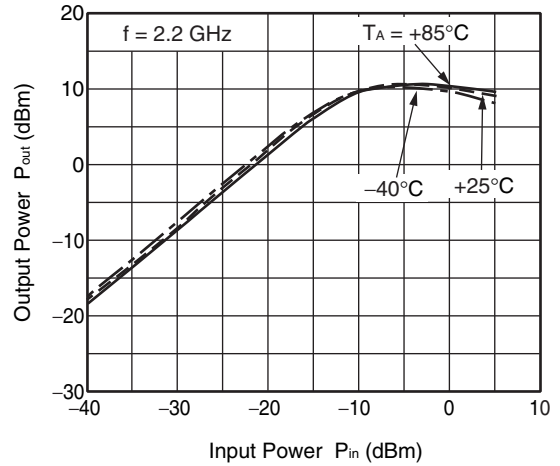

Remark The graphs indicate nominal characteristics.

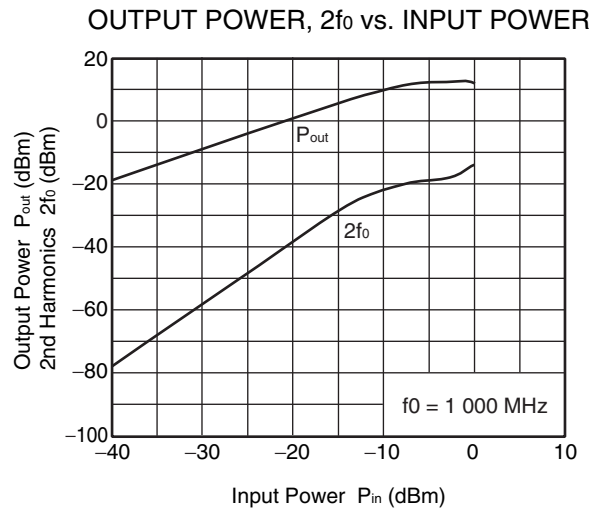
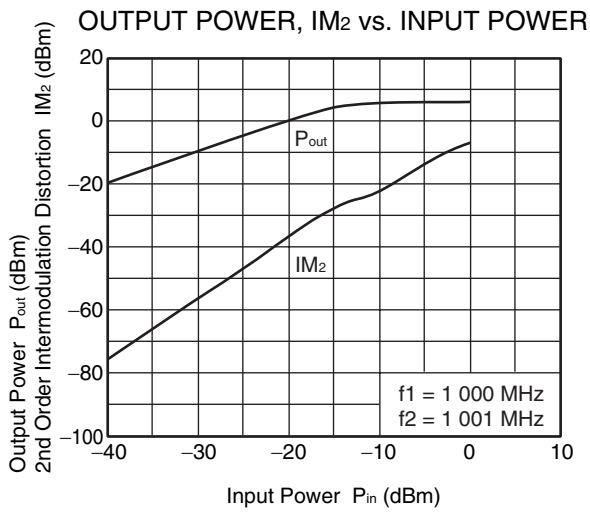
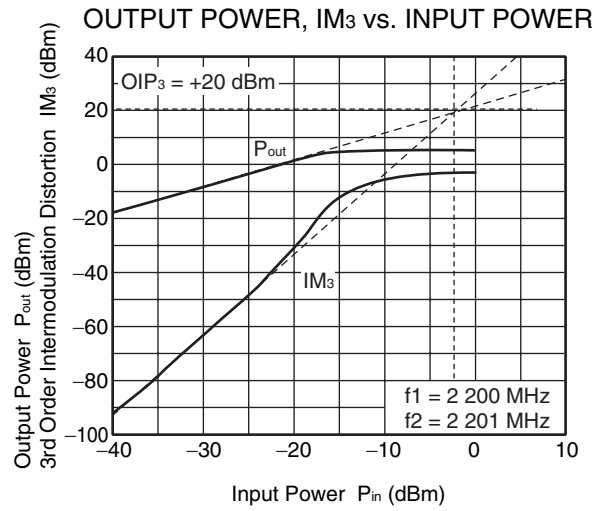
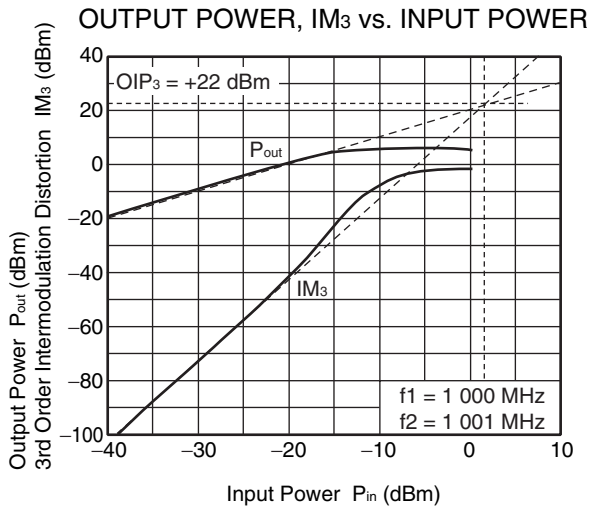

Remark The graphs indicate nominal characteristics.

S-PARAMETERS 1 (HIGH-GAIN MODE)

(T_A = +25°C, V_{CC} = 3.3 V, Gselect = GND, monitored at connector on board)

S₁₁-FREQUENCY

Δ 1 : 1 000 MHz 38.10 Ω -24.75 Ω
Δ 2 : 2 200 MHz 38.35 Ω 1.05 Ω

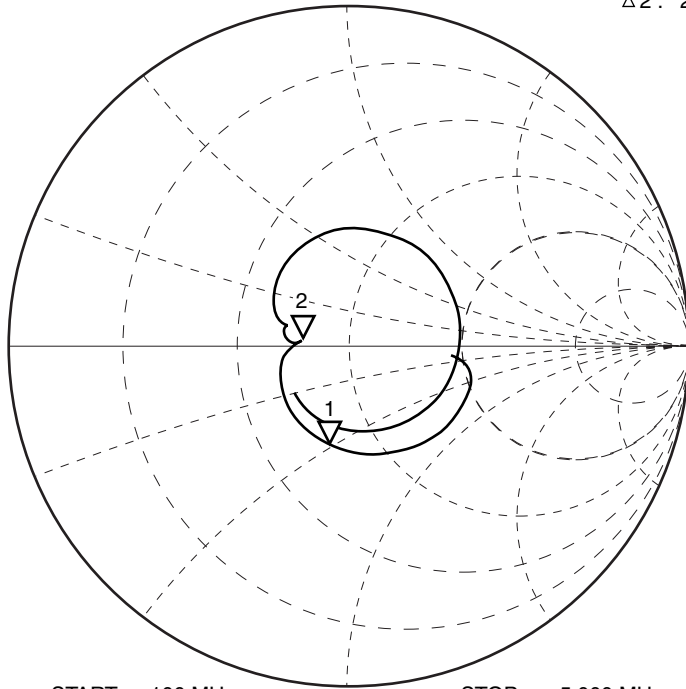

START: 100 MHz

STOP : 5 000 MHz

S₂₂-FREQUENCY

Δ 1 : 1 000 MHz 52.22 Ω -0.80 Ω
Δ 2 : 2 200 MHz 79.35 Ω -14.30 Ω

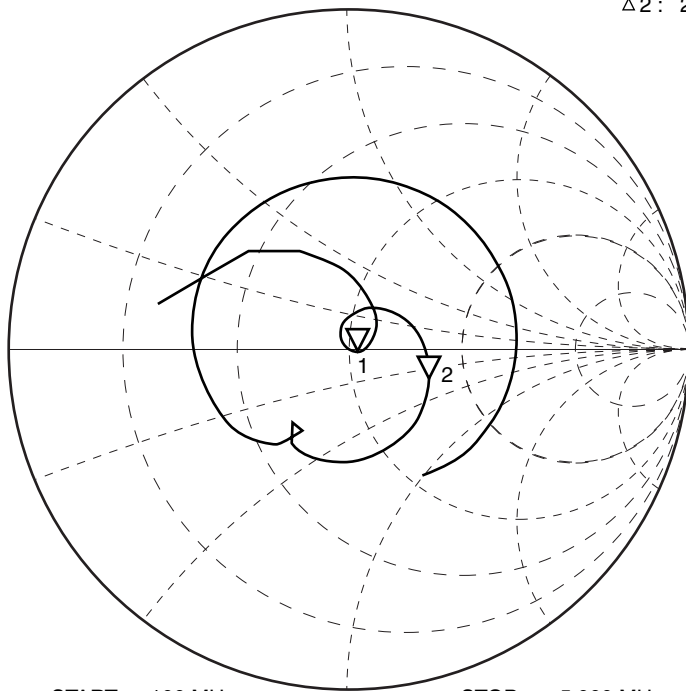

START: 100 MHz

STOP : 5 000 MHz

Remark The graphs indicate nominal characteristics.

TYPICAL CHARACTERISTICS 2 (MIDDLE-GAIN MODE)

($T_A = +25^\circ\text{C}$, $V_{CC} = 3.3\text{ V}$, Gselect = Open, $Z_S = Z_L = 50\ \Omega$, unless otherwise specified)

CIRCUIT CURRENT vs. SUPPLY VOLTAGE

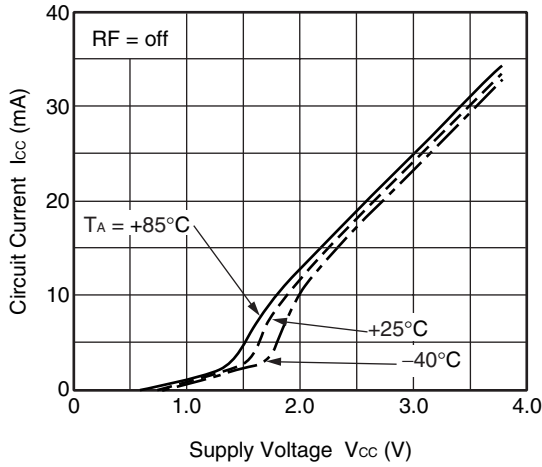

CIRCUIT CURRENT vs. OPERATING AMBIENT TEMPERATURE

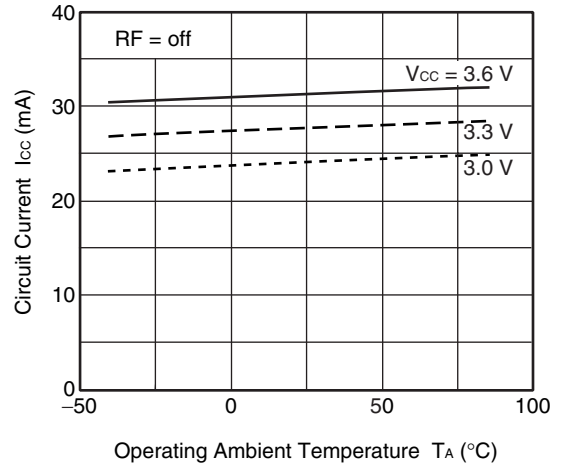

POWER GAIN vs. FREQUENCY

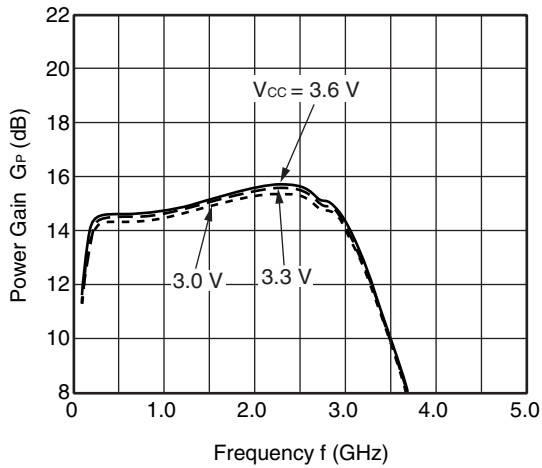

POWER GAIN vs. FREQUENCY

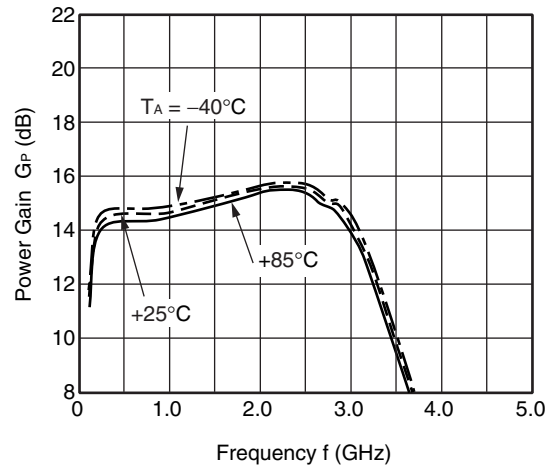

INPUT RETURN LOSS vs. FREQUENCY

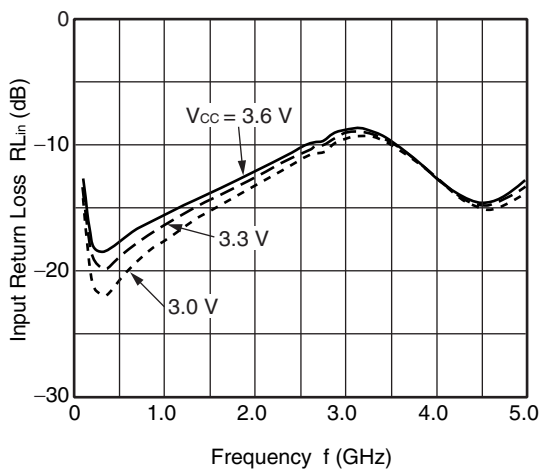

INPUT RETURN LOSS vs. FREQUENCY

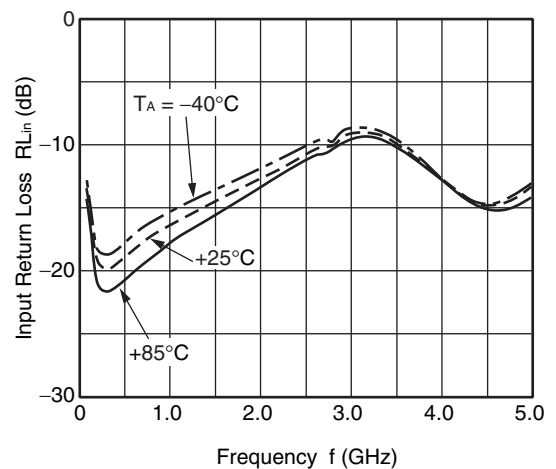

Remark The graphs indicate nominal characteristics.

OUTPUT RETURN LOSS vs. FREQUENCY

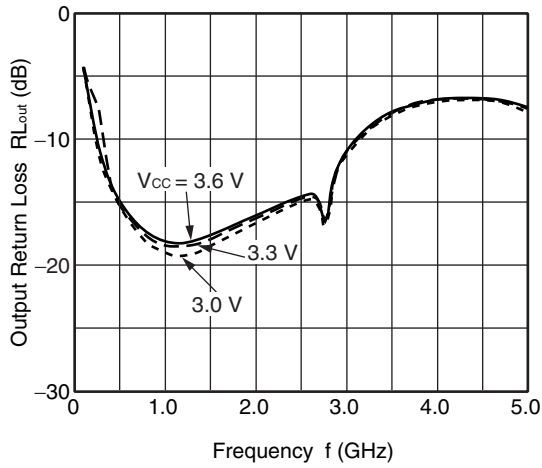

OUTPUT RETURN LOSS vs. FREQUENCY

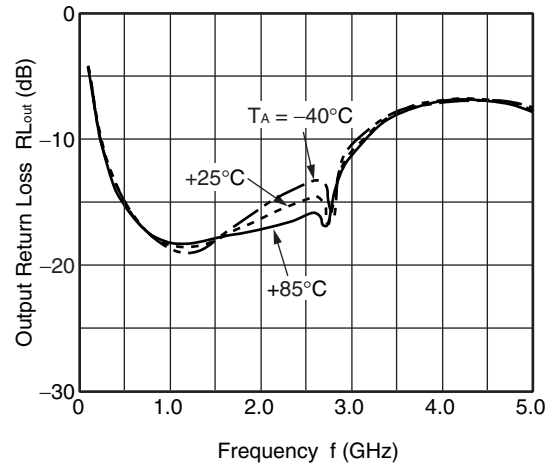

ISOLATION vs. FREQUENCY

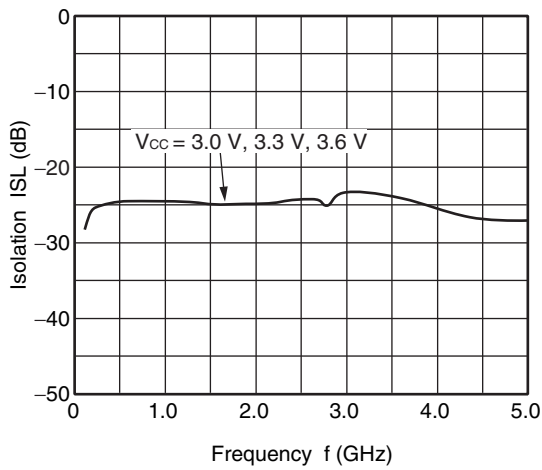

ISOLATION vs. FREQUENCY

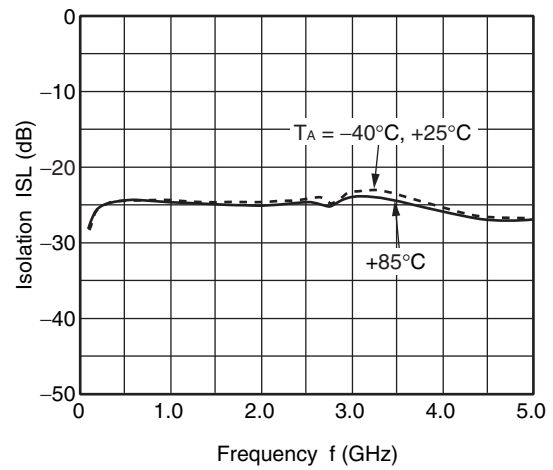

K FACTOR vs. FREQUENCY

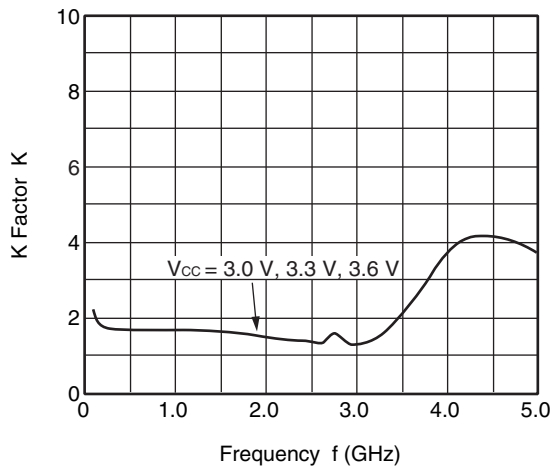

K FACTOR vs. FREQUENCY

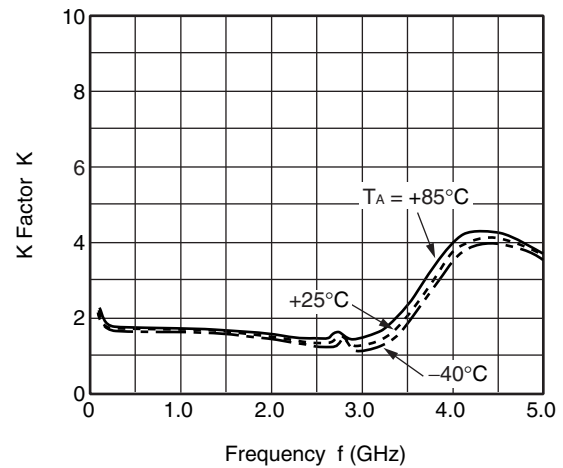

Remark The graphs indicate nominal characteristics.

NOISE FIGURE vs. FREQUENCY

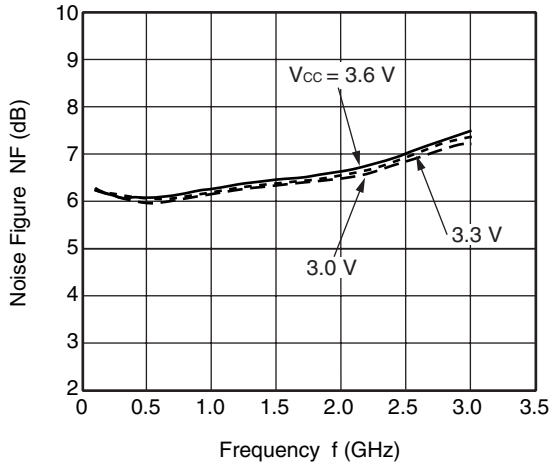

NOISE FIGURE vs. FREQUENCY

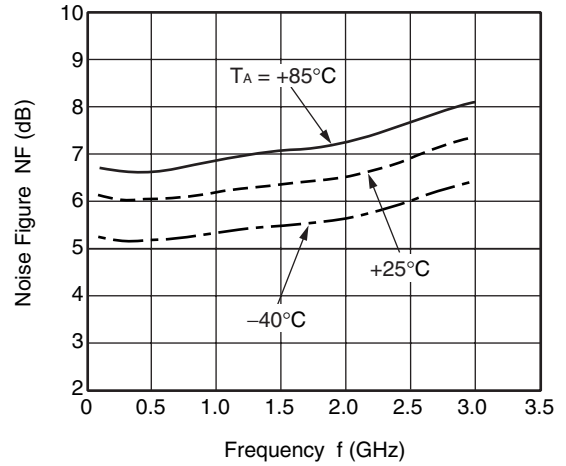

OUTPUT POWER vs. INPUT POWER

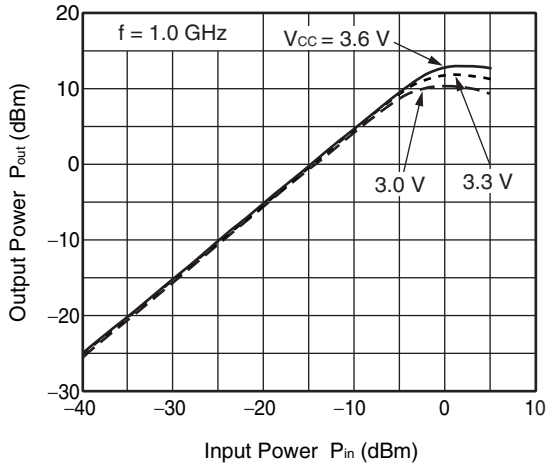

OUTPUT POWER vs. INPUT POWER

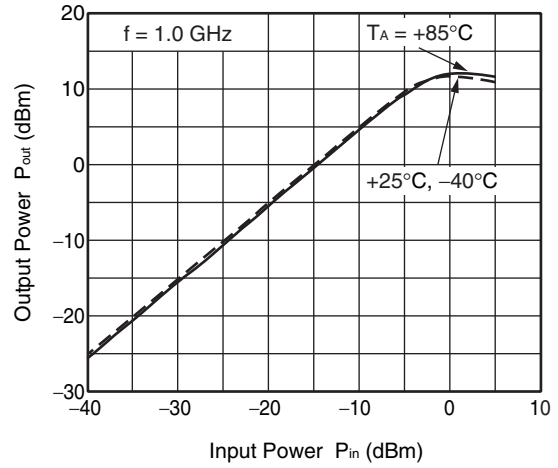

OUTPUT POWER vs. INPUT POWER

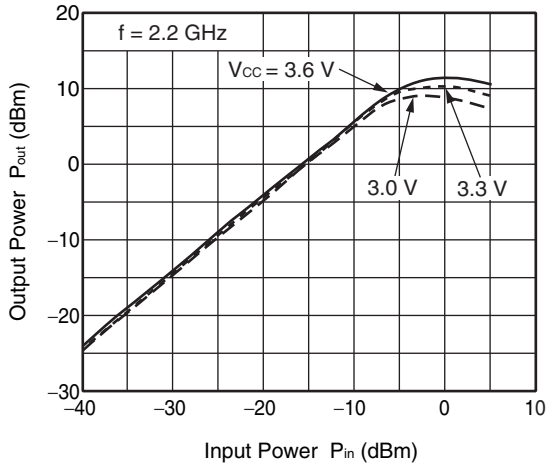

OUTPUT POWER vs. INPUT POWER

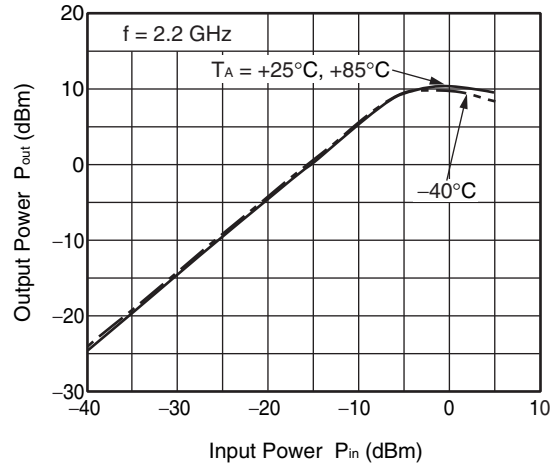

Remark The graphs indicate nominal characteristics.

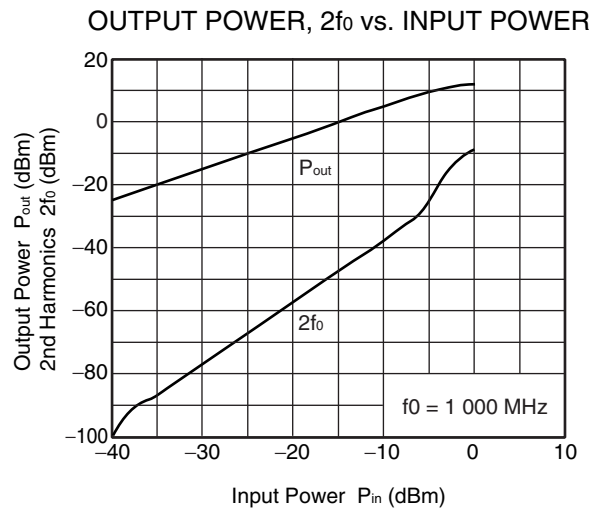
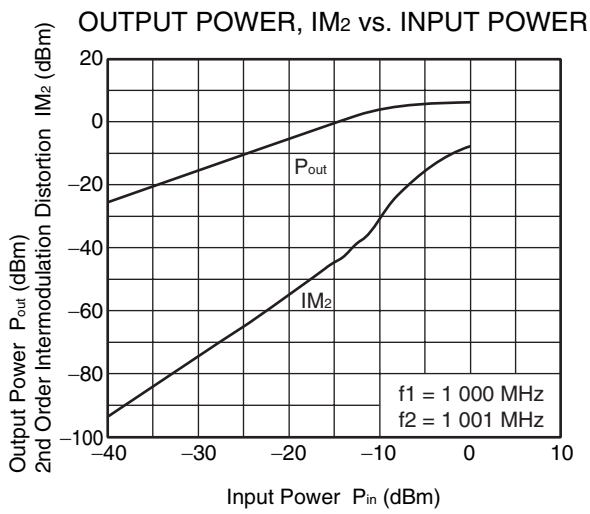
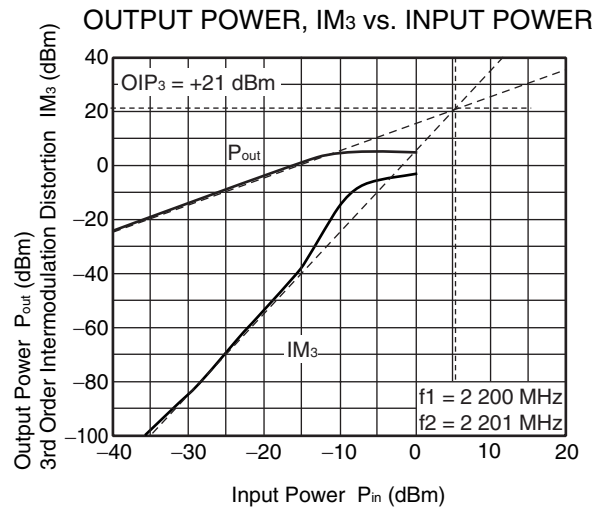
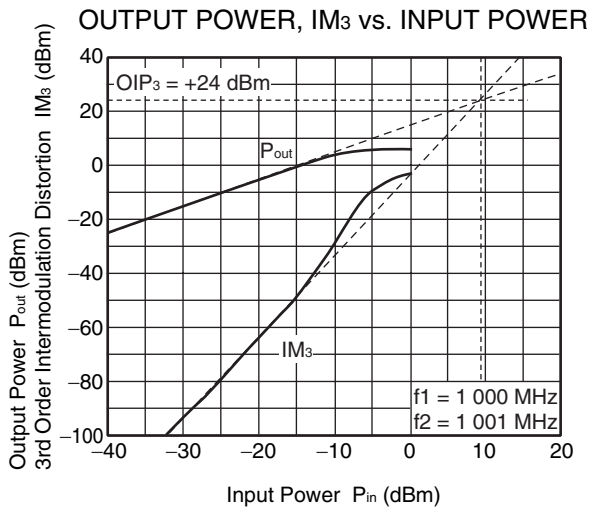

Remark The graphs indicate nominal characteristics.

S-PARAMETERS 2 (MIDDLE-GAIN MODE)

(T_A = +25°C, V_{CC} = 3.3 V, Gselect = Open, monitored at connector on board)

S₁₁-FREQUENCY

Δ 1 : 1 000 MHz 54.35 Ω 15.40 Ω
Δ 2 : 2 200 MHz 54.10 Ω -26.80 Ω

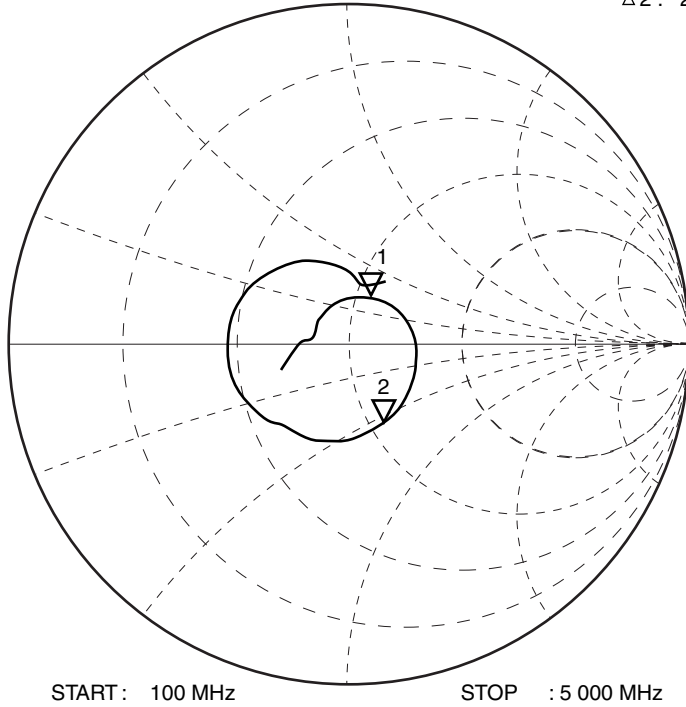

S₂₂-FREQUENCY

Δ 1 : 1 000 MHz 45.95 Ω -10.80 Ω
Δ 2 : 2 200 MHz 66.50 Ω 9.75 Ω

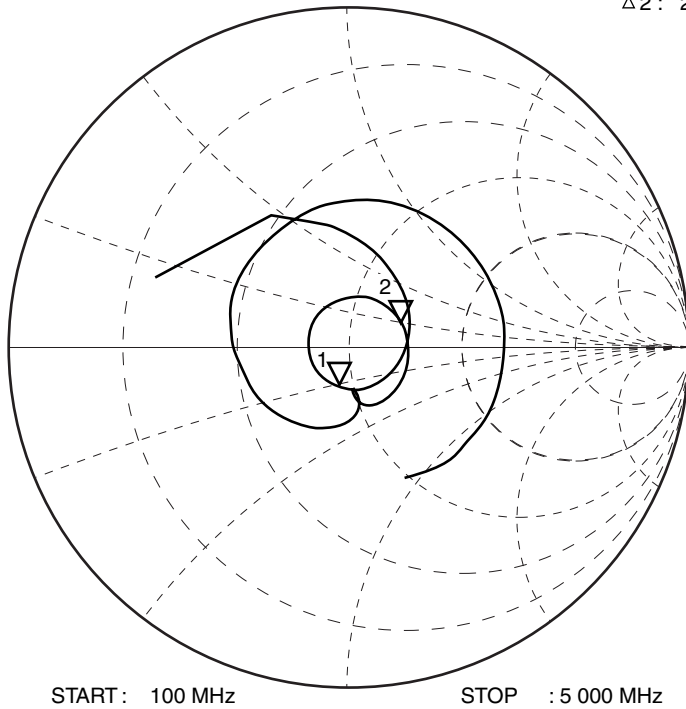

Remark The graphs indicate nominal characteristics.

TYPICAL CHARACTERISTICS 3 (LOW-GAIN MODE)

($T_A = +25^\circ\text{C}$, $V_{CC} = 3.3\text{ V}$, $G_{\text{select}} = V_{CC}$, $Z_S = Z_L = 50\ \Omega$, unless otherwise specified)

CIRCUIT CURRENT vs. SUPPLY VOLTAGE

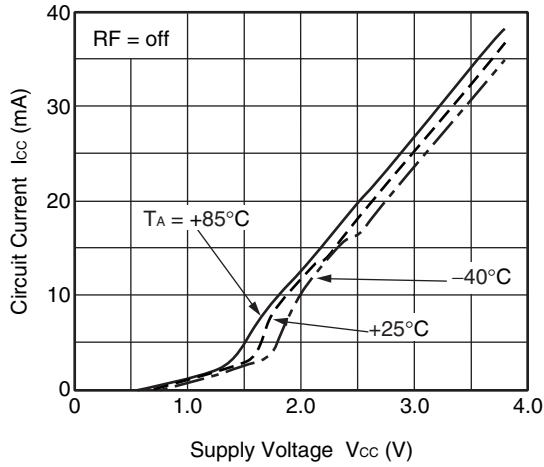

CIRCUIT CURRENT vs. OPERATING AMBIENT TEMPERATURE

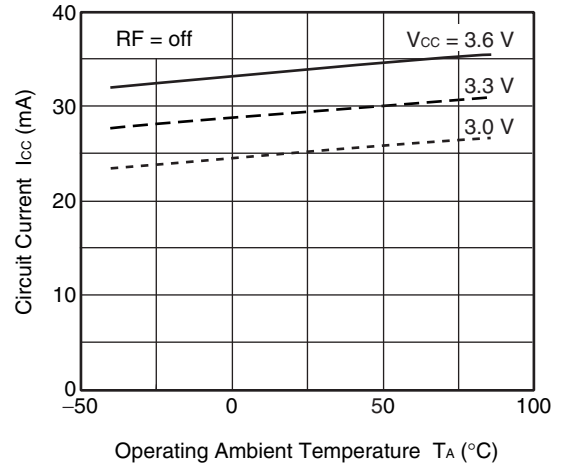

POWER GAIN vs. FREQUENCY

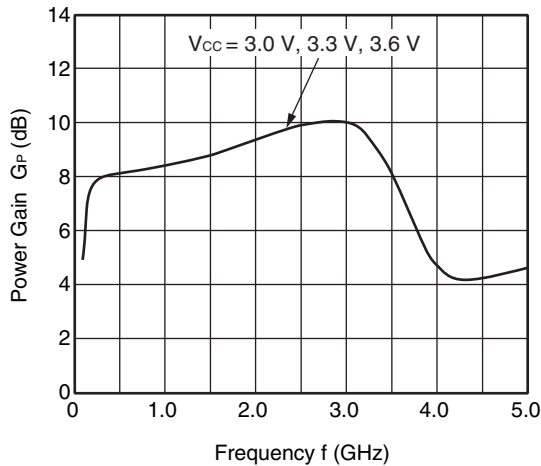

POWER GAIN vs. FREQUENCY

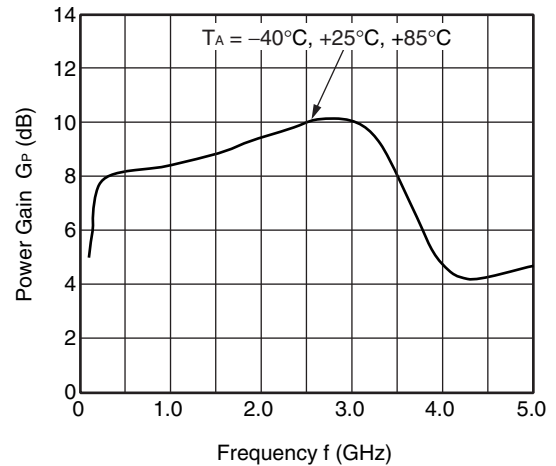

INPUT RETURN LOSS vs. FREQUENCY

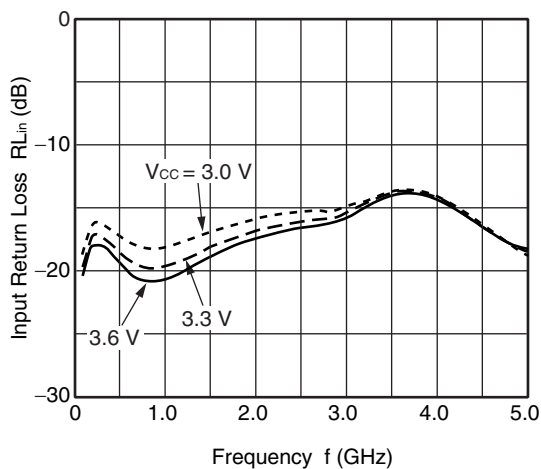

INPUT RETURN LOSS vs. FREQUENCY

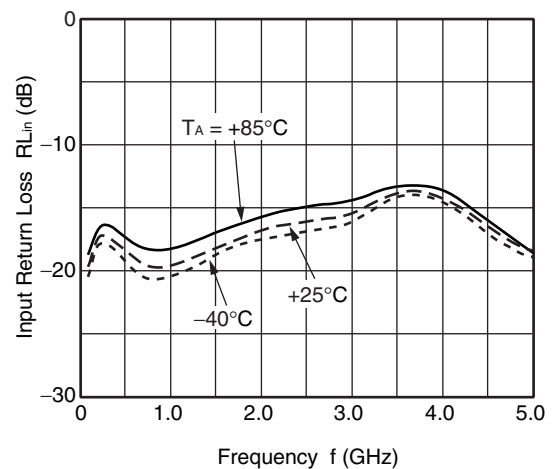

Remark The graphs indicate nominal characteristics.

OUTPUT RETURN LOSS vs. FREQUENCY

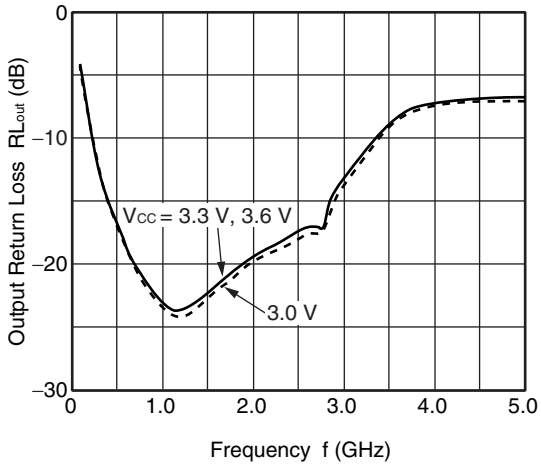

OUTPUT RETURN LOSS vs. FREQUENCY

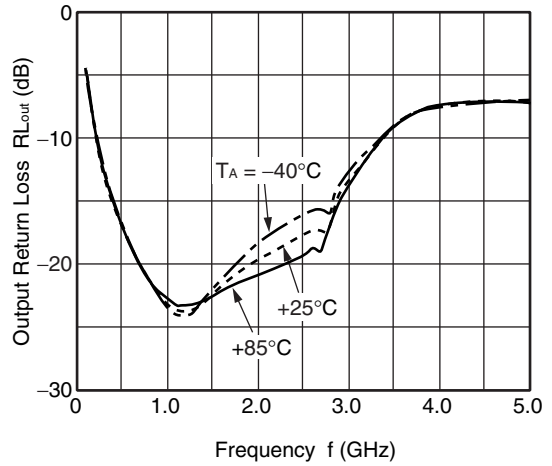

ISOLATION vs. FREQUENCY

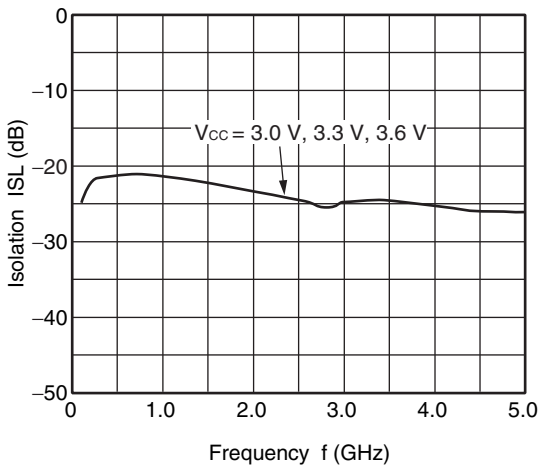

ISOLATION vs. FREQUENCY

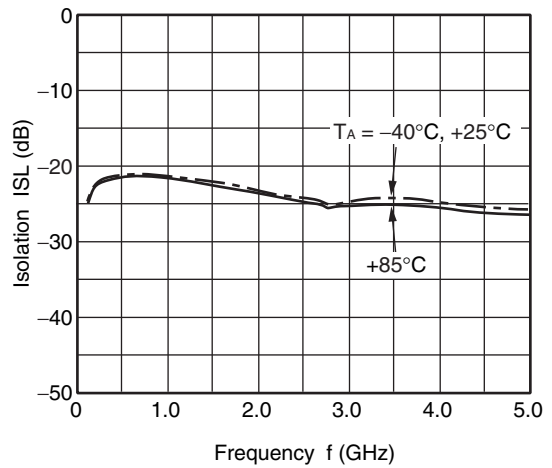

K FACTOR vs. FREQUENCY

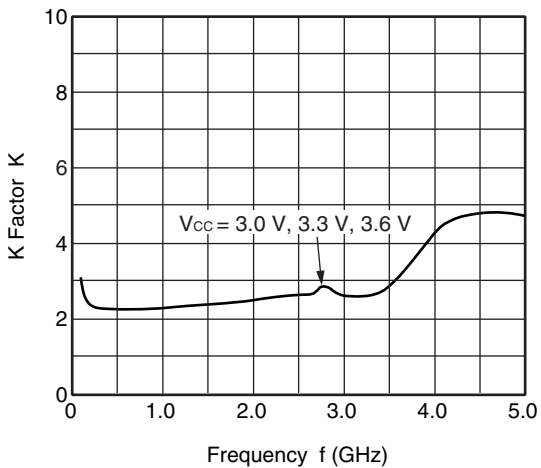

K FACTOR vs. FREQUENCY

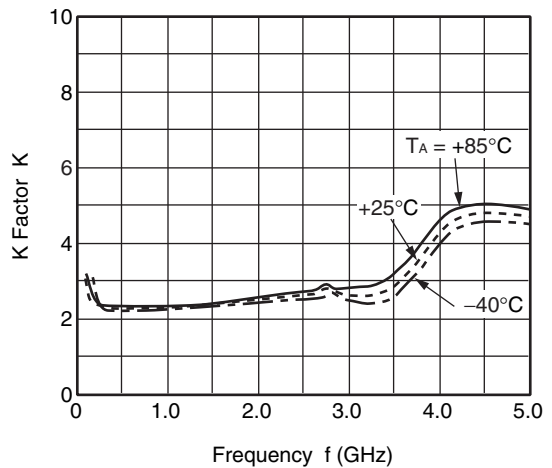

Remark The graphs indicate nominal characteristics.

NOISE FIGURE vs. FREQUENCY

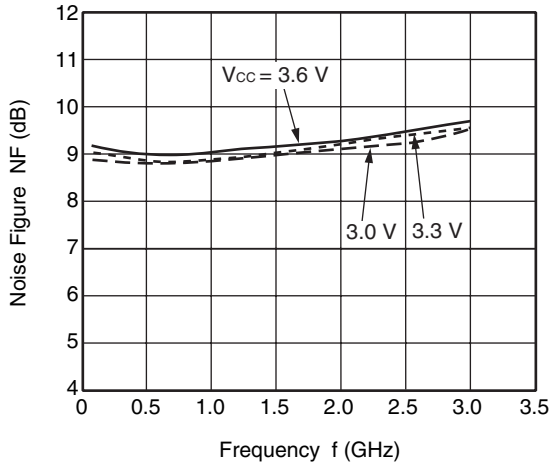

NOISE FIGURE vs. FREQUENCY

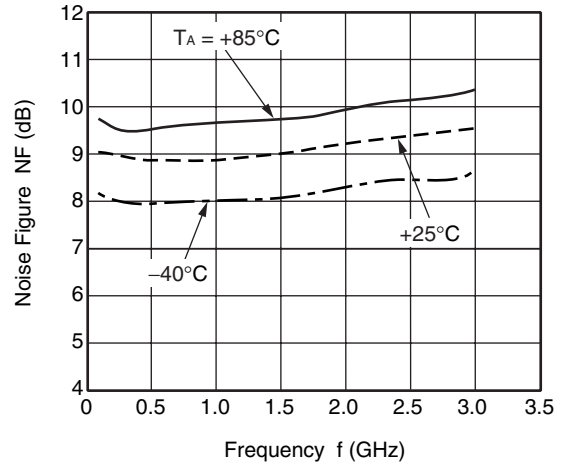

OUTPUT POWER vs. INPUT POWER

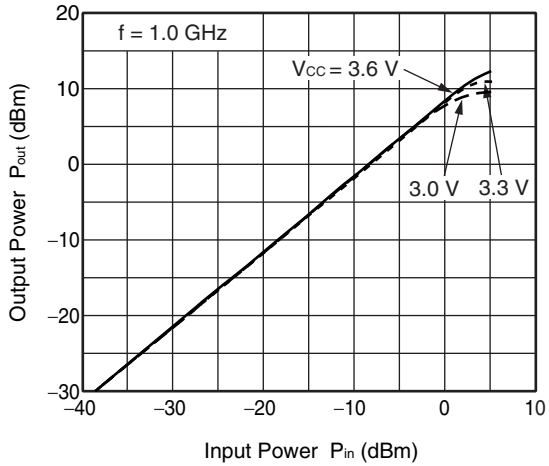

OUTPUT POWER vs. INPUT POWER

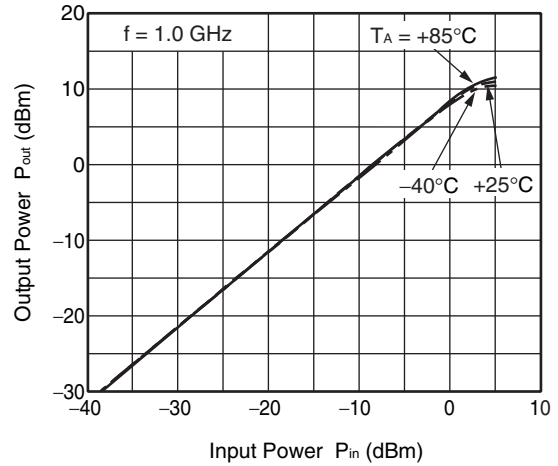

OUTPUT POWER vs. INPUT POWER

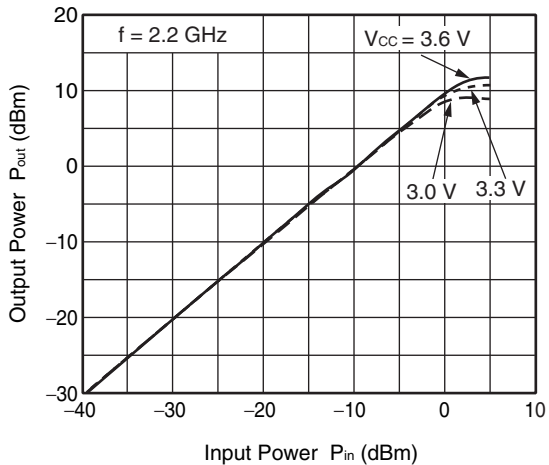

OUTPUT POWER vs. INPUT POWER

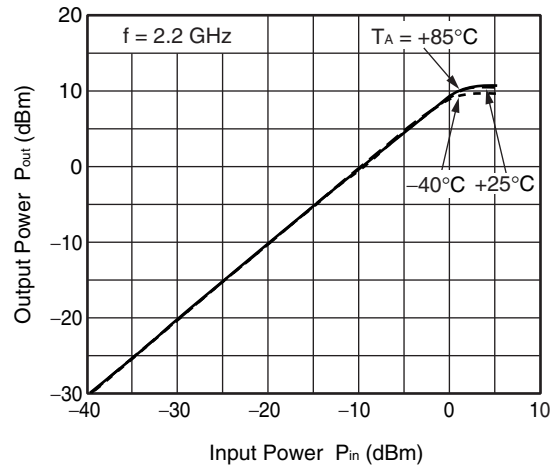

Remark The graphs indicate nominal characteristics.

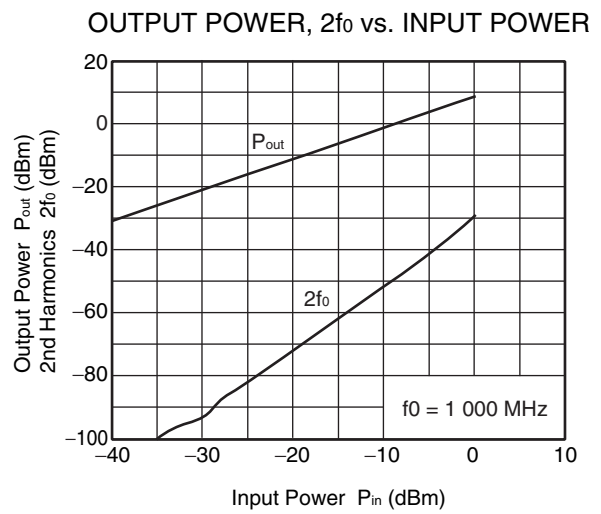
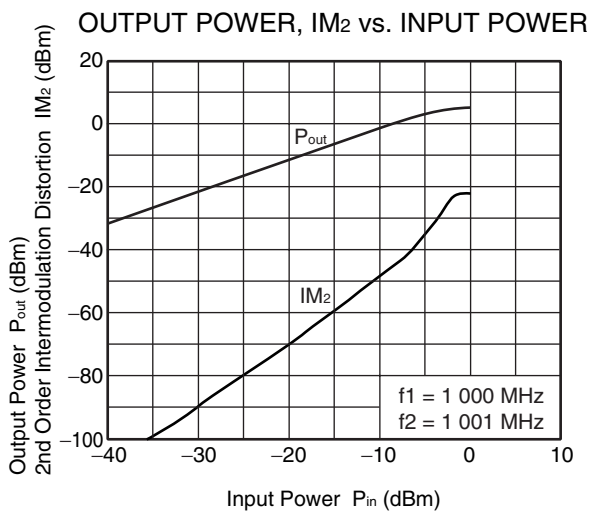
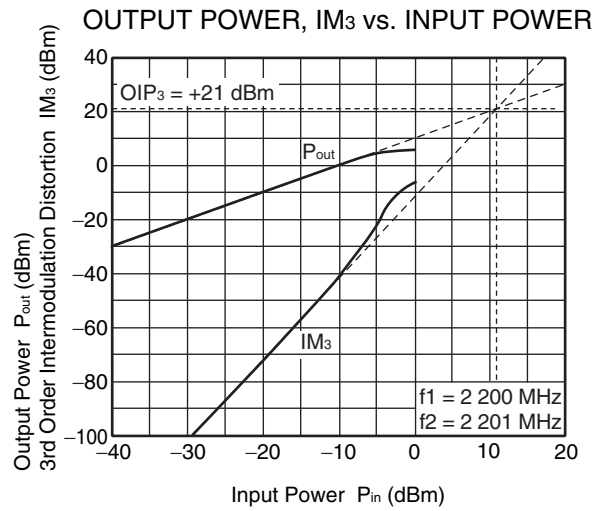
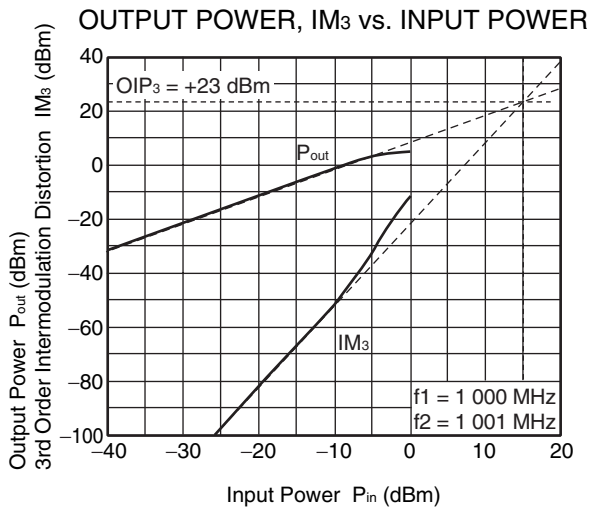

Remark The graphs indicate nominal characteristics.

S-PARAMETERS 3 (LOW-GAIN MODE)

($T_A = +25^\circ\text{C}$, $V_{CC} = 3.3\text{ V}$, $G_{\text{select}} = V_{CC}$, monitored at connector on board)

S₁₁-FREQUENCY

Δ 1 : 1 000 MHz 53.90 Ω -10.05 Ω
Δ 2 : 2 200 MHz 39.15 Ω -7.65 Ω

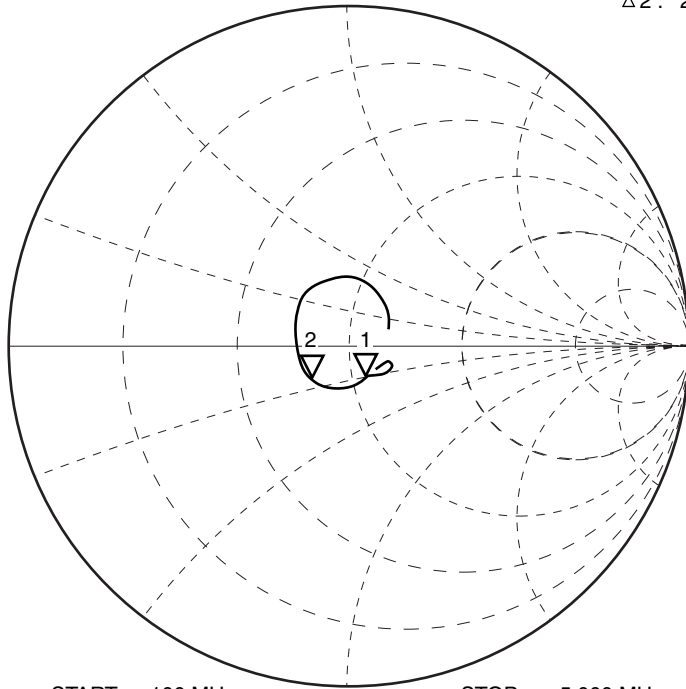

START: 100 MHz

STOP : 5 000 MHz

S₂₂-FREQUENCY

Δ 1 : 1 000 MHz 48.90 Ω -6.80 Ω
Δ 2 : 2 200 MHz 61.30 Ω 6.15 Ω

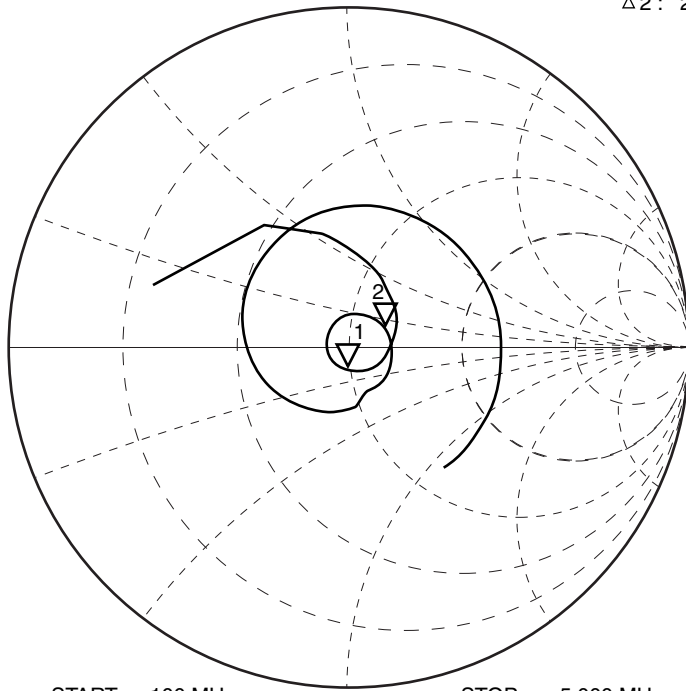

START: 100 MHz

STOP : 5 000 MHz

Remark The graphs indicate nominal characteristics.

PACKAGE DIMENSIONS

6-PIN SUPER MINIMOLD (UNIT: mm)

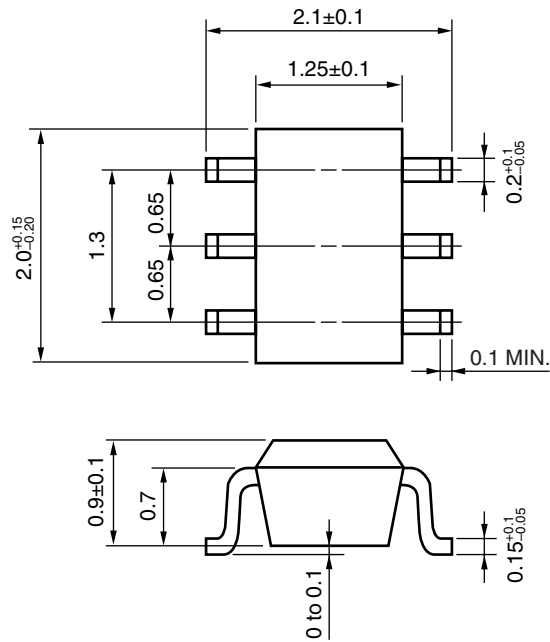

NOTES ON CORRECT USE

- (1) Observe precautions for handling because of electro-static sensitive devices.
- (2) Form a ground pattern as widely as possible to minimize ground impedance (to prevent undesired oscillation).
All the ground terminals must be connected together with wide ground pattern to decrease impedance difference.
- (3) The bypass capacitor should be attached to the V_{CC} line.
- (4) The inductor (L) must be attached between V_{CC} and output pins. The inductance value should be determined in accordance with desired frequency.
- (5) The DC cut capacitor must be attached to input and output pin.

RECOMMENDED SOLDERING CONDITIONS

This product should be soldered and mounted under the following recommended conditions. For soldering methods and conditions other than those recommended below, contact your nearby sales office.

Soldering Method	Soldering Conditions	Condition Symbol
Infrared Reflow	Peak temperature (package surface temperature) : 260°C or below Time at peak temperature : 10 seconds or less Time at temperature of 220°C or higher : 60 seconds or less Preheating time at 120 to 180°C : 120±30 seconds Maximum number of reflow processes : 3 times Maximum chlorine content of rosin flux (% mass) : 0.2% (Wt.) or below	IR260
Wave Soldering	Peak temperature (molten solder temperature) : 260°C or below Time at peak temperature : 10 seconds or less Preheating temperature (package surface temperature) : 120°C or below Maximum number of flow processes : 1 time Maximum chlorine content of rosin flux (% mass) : 0.2% (Wt.) or below	WS260
Partial Heating	Peak temperature (package surface temperature) : 350°C or below Soldering time (per side of device) : 3 seconds or less Maximum chlorine content of rosin flux (% mass) : 0.2% (Wt.) or below	HS350

CAUTION

Do not use different soldering methods together (except for partial heating).

Revision History	μPC3245TB Data Sheet
-------------------------	-----------------------------

Rev.	Date	Description	
		Page	Summary
1.00	Sep 26, 2011	–	First edition issued

All trademarks and registered trademarks are the property of their respective owners.

Notice

- All information included in this document is current as of the date this document is issued. Such information, however, is subject to change without any prior notice. Before purchasing or using any Renesas Electronics products listed herein, please confirm the latest product information with a Renesas Electronics sales office. Also, please pay regular and careful attention to additional and different information to be disclosed by Renesas Electronics such as that disclosed through our website.
- Renesas Electronics does not assume any liability for infringement of patents, copyrights, or other intellectual property rights of third parties by or arising from the use of Renesas Electronics products or technical information described in this document. No license, express, implied or otherwise, is granted hereby under any patents, copyrights or other intellectual property rights of Renesas Electronics or others.
- You should not alter, modify, copy, or otherwise misappropriate any Renesas Electronics product, whether in whole or in part.
- Descriptions of circuits, software and other related information in this document are provided only to illustrate the operation of semiconductor products and application examples. You are fully responsible for the incorporation of these circuits, software, and information in the design of your equipment. Renesas Electronics assumes no responsibility for any losses incurred by you or third parties arising from the use of these circuits, software, or information.
- When exporting the products or technology described in this document, you should comply with the applicable export control laws and regulations and follow the procedures required by such laws and regulations. You should not use Renesas Electronics products or the technology described in this document for any purpose relating to military applications or use by the military, including but not limited to the development of weapons of mass destruction. Renesas Electronics products and technology may not be used for or incorporated into any products or systems whose manufacture, use, or sale is prohibited under any applicable domestic or foreign laws or regulations.
- Renesas Electronics has used reasonable care in preparing the information included in this document, but Renesas Electronics does not warrant that such information is error free. Renesas Electronics assumes no liability whatsoever for any damages incurred by you resulting from errors in or omissions from the information included herein.
- Renesas Electronics products are classified according to the following three quality grades: "Standard", "High Quality", and "Specific". The recommended applications for each Renesas Electronics product depends on the product's quality grade, as indicated below. You must check the quality grade of each Renesas Electronics product before using it in a particular application. You may not use any Renesas Electronics product for any application categorized as "Specific" without the prior written consent of Renesas Electronics. Further, you may not use any Renesas Electronics product for any application for which it is not intended without the prior written consent of Renesas Electronics. Renesas Electronics shall not be in any way liable for any damages or losses incurred by you or third parties arising from the use of any Renesas Electronics product for an application categorized as "Specific" or for which the product is not intended where you have failed to obtain the prior written consent of Renesas Electronics. The quality grade of each Renesas Electronics product is "Standard" unless otherwise expressly specified in a Renesas Electronics data sheets or data books, etc.
"Standard": Computers; office equipment; communications equipment; test and measurement equipment; audio and visual equipment; home electronic appliances; machine tools; personal electronic equipment; and industrial robots.
"High Quality": Transportation equipment (automobiles, trains, ships, etc.); traffic control systems; anti-disaster systems; anti-crime systems; safety equipment; and medical equipment not specifically designed for life support.
"Specific": Aircraft; aerospace equipment; submersible repeaters; nuclear reactor control systems; medical equipment or systems for life support (e.g. artificial life support devices or systems), surgical implantations, or healthcare intervention (e.g. excision, etc.), and any other applications or purposes that pose a direct threat to human life.
- You should use the Renesas Electronics products described in this document within the range specified by Renesas Electronics, especially with respect to the maximum rating, operating supply voltage range, movement power voltage range, heat radiation characteristics, installation and other product characteristics. Renesas Electronics shall have no liability for malfunctions or damages arising out of the use of Renesas Electronics products beyond such specified ranges.
- Although Renesas Electronics endeavors to improve the quality and reliability of its products, semiconductor products have specific characteristics such as the occurrence of failure at a certain rate and malfunctions under certain use conditions. Further, Renesas Electronics products are not subject to radiation resistance design. Please be sure to implement safety measures to guard them against the possibility of physical injury, and injury or damage caused by fire in the event of the failure of a Renesas Electronics product, such as safety design for hardware and software including but not limited to redundancy, fire control and malfunction prevention, appropriate treatment for aging degradation or any other appropriate measures. Because the evaluation of microcomputer software alone is very difficult, please evaluate the safety of the final products or system manufactured by you.
- Please contact a Renesas Electronics sales office for details as to environmental matters such as the environmental compatibility of each Renesas Electronics product. Please use Renesas Electronics products in compliance with all applicable laws and regulations that regulate the inclusion or use of controlled substances, including without limitation, the EU RoHS Directive. Renesas Electronics assumes no liability for damages or losses occurring as a result of your noncompliance with applicable laws and regulations.
- This document may not be reproduced or duplicated, in any form, in whole or in part, without prior written consent of Renesas Electronics.
- Please contact a Renesas Electronics sales office if you have any questions regarding the information contained in this document or Renesas Electronics products, or if you have any other inquiries.
(Note 1) "Renesas Electronics" as used in this document means Renesas Electronics Corporation and also includes its majority-owned subsidiaries.
(Note 2) "Renesas Electronics product(s)" means any product developed or manufactured by or for Renesas Electronics.



SALES OFFICES

Renesas Electronics Corporation

<http://www.renesas.com>

Refer to "<http://www.renesas.com/>" for the latest and detailed information.

Renesas Electronics America Inc.
2880 Scott Boulevard Santa Clara, CA 95050-2554, U.S.A.
Tel: +1-408-586-6000, Fax: +1-408-588-6130

Renesas Electronics Canada Limited
1101 Nicholson Road, Newmarket, Ontario L3Y 9C3, Canada
Tel: +1-905-898-5441, Fax: +1-905-898-3220

Renesas Electronics Europe Limited
Dukes Meadow, Millboard Road, Bourne End, Buckinghamshire, SL8 5FH, U.K.
Tel: +44-1628-585-100, Fax: +44-1628-585-900

Renesas Electronics Europe GmbH
Arcadiastrasse 10, 40472 Düsseldorf, Germany
Tel: +49-211-65030, Fax: +49-211-6503-1327

Renesas Electronics (China) Co., Ltd.
7th Floor, Quantum Plaza, No.27 ZhiChunLu Haidian District, Beijing 100083, P.R.China
Tel: +86-10-8235-1155, Fax: +86-10-8235-7679

Renesas Electronics (Shanghai) Co., Ltd.
Unit 204, 205, AZIA Center, No.1233 Lujiazui Ring Rd., Pudong District, Shanghai 200120, China
Tel: +86-21-5877-1818, Fax: +86-21-6887-7858 / -7898

Renesas Electronics Hong Kong Limited
Unit 1601-1613, 16/F., Tower 2, Grand Century Place, 193 Prince Edward Road West, Mongkok, Kowloon, Hong Kong
Tel: +852-2886-9318, Fax: +852 2886-9022/9044

Renesas Electronics Taiwan Co., Ltd.
13F, No. 363, Fu Shing North Road, Taipei, Taiwan
Tel: +886-2-8175-9600, Fax: +886 2-8175-9670

Renesas Electronics Singapore Pte. Ltd.
1 HarbourFront Avenue, #06-10, Keppel Bay Tower, Singapore 098632
Tel: +65-6213-0200, Fax: +65-6276-8001

Renesas Electronics Malaysia Sdn.Bhd.
Unit 906, Block B, Menara Amcorp, Amcorp Trade Centre, No. 18, Jin Persiaran Barat, 46050 Petaling Jaya, Selangor Darul Ehsan, Malaysia
Tel: +60-3-7955-9390, Fax: +60-3-7955-9510

Renesas Electronics Korea Co., Ltd.
11F., Samik Lavied' or Bldg., 720-2 Yeoksam-Dong, Kangnam-Ku, Seoul 135-080, Korea
Tel: +82-2-558-3737, Fax: +82-2-558-5141