

MIXER + OSCILLATOR IC FOR PAGER SYSTEM

DESCRIPTION

$\mu$ PC8103T and  $\mu$ PC8108T are silicon monolithic integrated circuits designed as mixer-oscillator series for pager system. Due to 1 V supply voltage, these ICs are suitable for low voltage pager system. These ICs are packaged in 6 pin mini mold suitable for high-density surface mounting.

These ICs are manufactured using NEC's 20 GHz fr NESAT™ III silicon bipolar process. This process uses silicon nitride passivation film and gold electrodes. These materials contributes excellent DC, AC performance. Thus, these ICs are utilized as 1 V voltage ICs.

FEATURES

- 1 V supply voltage:  $V_{CC} = 1.0\text{ V to }2.0\text{ V}$
- Low current consumption
  - $\mu$ PC8103T:  $I_{CC} = 1.0\text{ mA TYP. @ }V_{CC} = 1.0\text{ V}$
  - $\mu$ PC8108T:  $I_{CC} = 1.5\text{ mA TYP. @ }V_{CC} = 1.0\text{ V}$
- Wide band operation
  - $\mu$ PC8103T:  $f_{RF} = 150\text{ MHz to }330\text{ MHz}$
  - $\mu$ PC8108T:  $f_{RF} = 150\text{ MHz to }930\text{ MHz}$
- High-density surface mounting: 6 pin mini mold

ORDERING INFORMATION

PART NUMBER	PACKAGE	SUPPLYING FORM
$\mu$ PC8103T-E3 $\mu$ PC8108T-E3	6pin mini mold	Embossed tape 8 mm wide, Pin 1, 2, 3 face to perforation side of tape. QTY 3 kp/Reel

**Note** To order evaluation samples, please contact your local NEC sales office. (Order number:  $\mu$ PC8103T,  $\mu$ PC8108T)

PIN CONNECTION

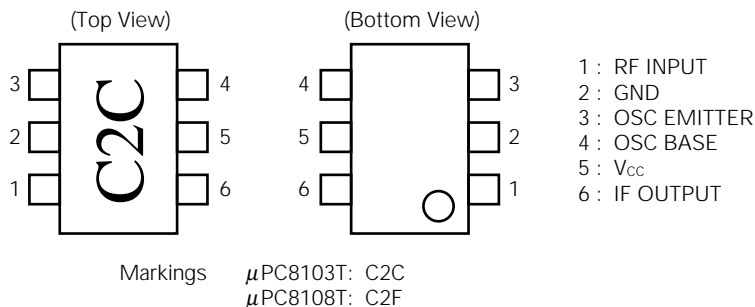

Caution Electro-static sensitive devices

INTERNAL BOLOCK DIAGRAM (IN COMMON)

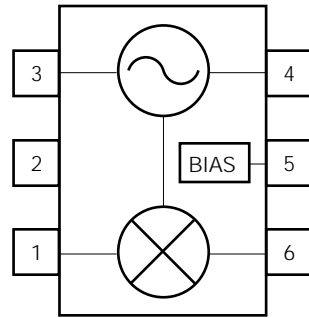

**Note** Resonator must be externally equipped with 3 and 4 pins. (Refer to pin explanations)

SYSTEM APPLICATION EXAMPLE AS PAGER

150 MHz to 330 MHz

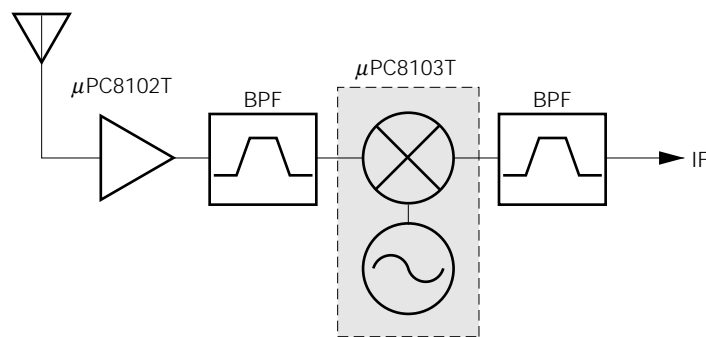

450 MHz to 930 MHz

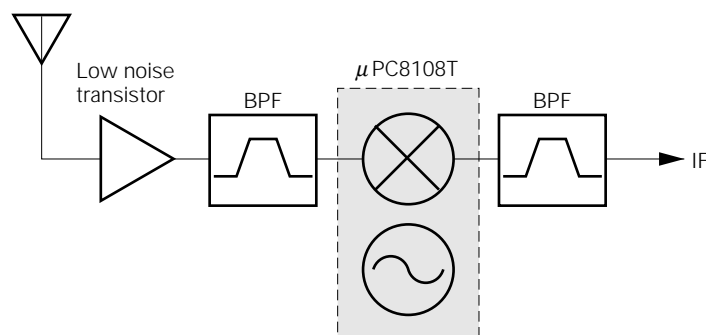

This system application example schematically presents the chip set product line-up only, and does not imply a detail application circuit (In the case of application circuit example for  $\mu$ PC8103T and  $\mu$ PC8108T, please refer to page 21).

For details on the related devices, refer to the latest data sheet of each device.

**PIN EXPLANATION ( $\mu$ PC8103T,  $\mu$ PC8108T IN COMMON)**

PIN NO.	PIN NAME	SUPPLY VOLTAGE (V)	PIN VOLTAGE (V)	FUNCTION AND APPLICATION	EQUIVALENT CIRCUIT
1	RF input	—	0.77	RF input for mixer. This port is low impedance.	
2	GND	0	—	This ground pin must be connected to the system ground with minimum inductance. Ground pattern on the board should be formed as wide as possible. Track length should be kept as short as possible.	
3	OSC Emitter	—	0.19	Emitter, base pins of internal transistor for oscillator.	
4	OSC Base	—	0.95	These pins should be externally equipped with resonator circuit of X'tal or LC.	
5	V <sub>cc</sub>	1.0 to 2.0	—	Supply voltage pin. Connect bypass capacitor (eg 1 000 pF) to minimize ground impedance.	
6	IF Output	Same bias as V <sub>cc</sub> through external inductor (L)	—	IF output pin from mixer. This pin is designed as open collector and should be equipped with inductor (L) because of high impedance port.	

**Note** Each PIN VOLTAGE is measured with V<sub>cc</sub> = 1.0 V.

Unless otherwise specified, both product in common.

**ABSOLUTE MAXIMUM RATINGS**

PARAMETER	SYMBOL	RATING	UNIT	CONDITIONS
Supply Voltage	V <sub>CC</sub>	4.0	V	T <sub>A</sub> = +25 °C, Pin 5 and 6
Power Dissipation	P <sub>D</sub>	280	mW	Mounted on 50 × 50 × 1.6 mm double copper clad epoxy glass PWB at T <sub>A</sub> = +85 °C
Operating Temperature	T <sub>A</sub>	-40 to +85	°C	
Storage Temperature	T <sub>stg</sub>	-55 to +150	°C	
IF Output Voltage Peak Level	V <sub>IFout MAX.</sub>	5	V	T <sub>A</sub> = +25 °C

**RECOMMENDED OPERATING CONDITIONS**

PARAMETER	SYMBOL	MIN.	TYP.	MAX.	UNIT	NOTE
Supply Voltage	V <sub>CC</sub>	1.0	1.05	2.0	V	Pin 5 and 6
Operating Temperature	T <sub>A</sub>	-25	+25	+75	°C	Possible to oscillate
RF Frequency	f <sub>RF</sub>	150		330	MHz	μPD8103T
RF Frequency	f <sub>RF</sub>	150		930	MHz	μPD8108T

**ELECTRICAL CHARACTERISTICS (T<sub>A</sub> = +25 °C, V<sub>CC</sub> = 1.0 V, Z<sub>S</sub> = 50 Ω, Z<sub>L</sub> = 2 kΩ, f<sub>IF</sub> = 20 MHz, P<sub>LoIn</sub> = -21 dBm externally, Upper local <sup>Note</sup>)**

PARAMETER	SYMBOL	μPC8103T			μPC8108T			UNIT	CONDITIONS
		MIN.	TYP.	MAX.	MIN.	TYP.	MAX.		
Circuit Current	I <sub>CC</sub>	0.55	1	1.4	1.0	1.5	2.1	mA	No input signals
Conversion Gain 1	CG1	13	16	19	17.5	20.5	23.5	dB	f <sub>RFin</sub> = 150 MHz, TEST CIRCUIT 1
Conversion Gain 2	CG2	12.5	15.5	18.5	17	20	23	dB	f <sub>RFin</sub> = 280 MHz, TEST CIRCUIT 1
Conversion Gain 3	CG3	12.5	15.5	18.5	17	20	23	dB	f <sub>RFin</sub> = 330 MHz, TEST CIRCUIT 1
Conversion Gain 4	CG4	-	-	-	16	19	22	dB	f <sub>RFin</sub> = 450 MHz, TEST CIRCUIT 1
Conversion Gain 5	CG5	-	-	-	12	15	18	dB	f <sub>RFin</sub> = 930 MHz, TEST CIRCUIT 1

**Note** Upper local means 'f<sub>IF</sub> = f<sub>LoIn</sub> - f<sub>RFin</sub>'.

STANDARD CHARACTERISTICS FOR REFERENCE ( $T_A = +25\text{ }^\circ\text{C}$ ,  $V_{CC} = 1.0\text{ V}$ ,  $Z_S = Z_L = 50\ \Omega$ ,  $f_{IF} = 20\text{ MHz}$ ,  $P_{LoIn}$  externally, Upper local)

PARAMETER	SYMBOL	$\mu$ PC8103T		$\mu$ PC8108T		UNIT	CONDITIONS
		$P_{LoIn} = -21\text{ dBm}$	$P_{LoIn} = -10\text{ dBm}$	$P_{LoIn} = -21\text{ dBm}$	$P_{LoIn} = -10\text{ dBm}$		
Noise Figure 1	NF1	13	9	13	8.5	dB	$f_{RFIn} = 150\text{ MHz}$ , TEST CIRCUIT 2
Noise Figure 2	NF2	11.5	8	12	7	dB	$f_{RFIn} = 280\text{ MHz}$ , TEST CIRCUIT 2
Noise Figure 3	NF3	12	9	13	8	dB	$f_{RFIn} = 330\text{ MHz}$ , TEST CIRCUIT 2
Noise Figure 4	NF4	-	-	13.5	8	dB	$f_{RFIn} = 450\text{ MHz}$ , TEST CIRCUIT 2
Noise Figure 5	NF5	-	-	18	11.5	dB	$f_{RFIn} = 930\text{ MHz}$ , TEST CIRCUIT 2

**Note** Upper local means ' $f_{IF} = f_{LoIn} - f_{RFIn}$ '.

**TEST CIRCUIT 1**

**$R_s = 50 \Omega$ ,  $R_L = 2 \text{ k}\Omega$  (CG MEASUREMENT)**

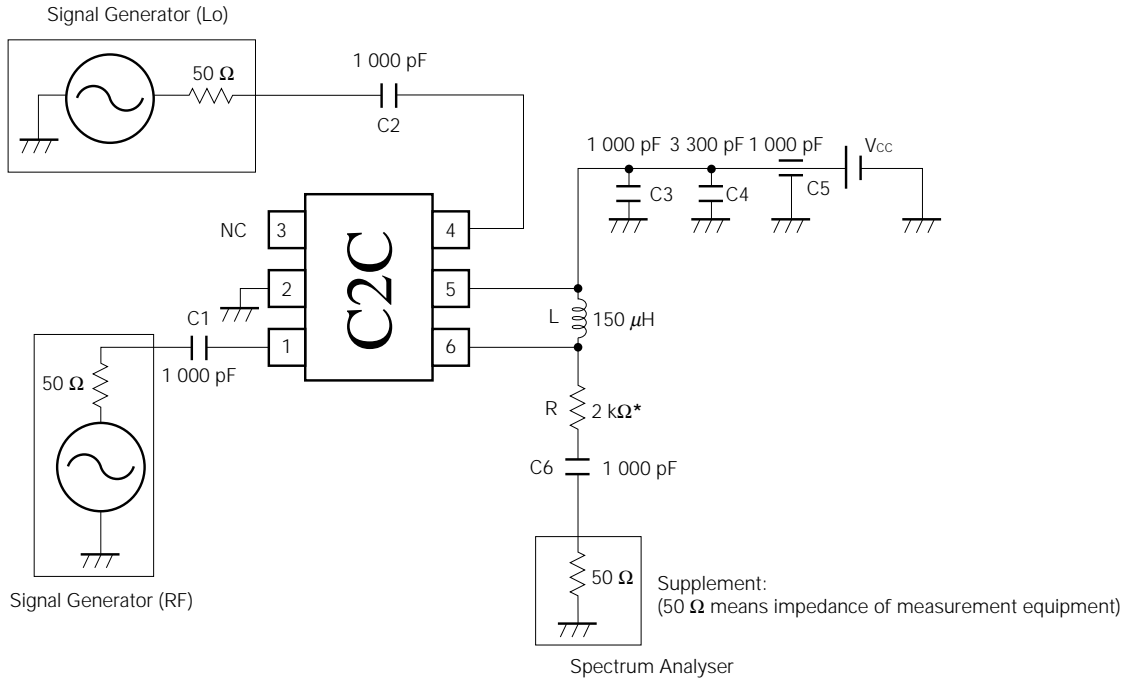

\* **Note** On 50 Ω measurement, this high impedance IFout needs the calculatiuon as follows

$$CG \text{ (dB)} = \text{Measured value} + 20 \log_{10} \frac{2 \text{ k}\Omega}{50 \Omega}$$

**TEST CIRCUIT 2**

**$R_s = R_L = 50 \Omega$  (NF MEASUREMENT)**

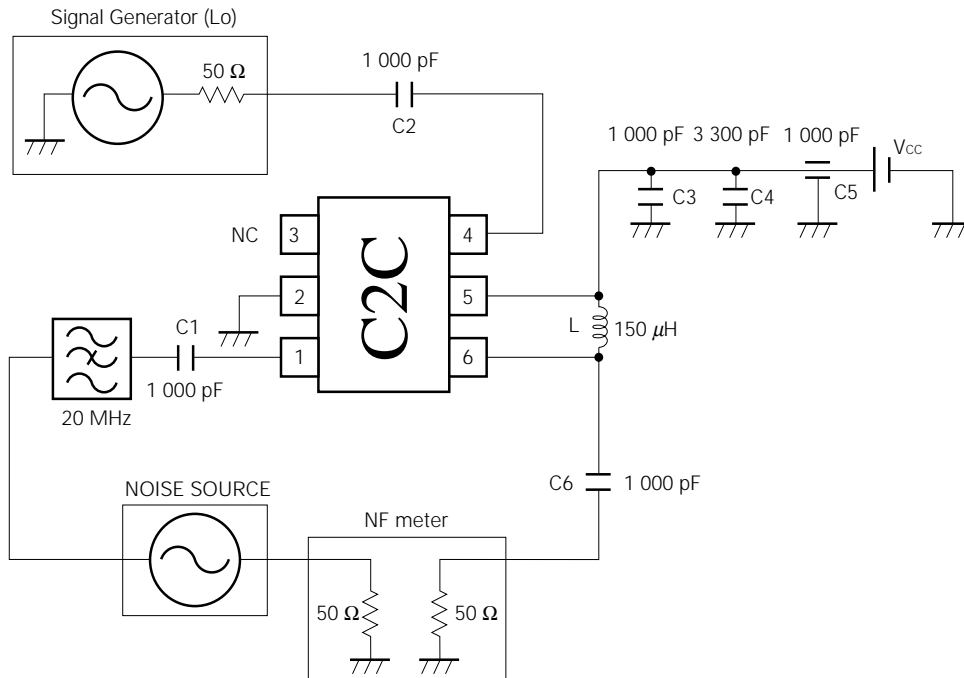
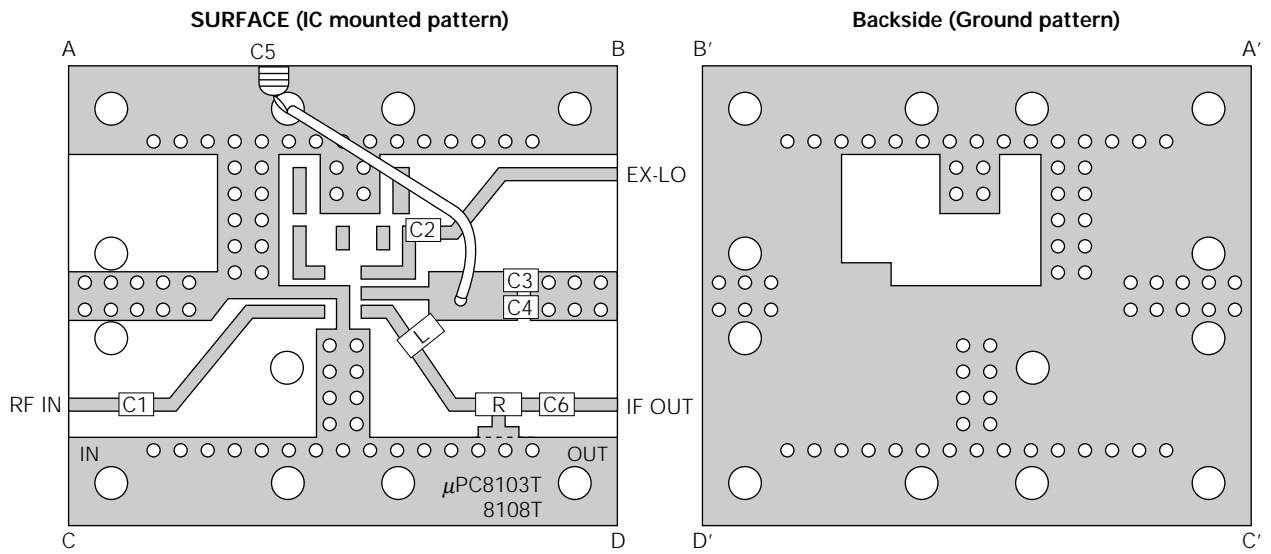



ILLUSTRATION OF TEST CIRCUITS ASSEMBLED ON EVALUATION BOARD



- Note**
- (\*1) 35 × 42 × 0.4 mm double sided copper clad polyimide board
  - (\*2) Solder plated pattern
  - (\*3) Surface vs. backside : A - A', B - B', C - C', D - D'
  - (\*4)  should be removed.
  - (\*5) In the care of NF measurement, remove R and short.
  - (\*6) ○ ○ : Through holes

CHARACTERISTIC CURVES (Unless otherwise specified with TEST CIRCUIT 1 or 2)

—  $\mu$ PC8103T —

CIRCUIT CURRENT vs. SUPPLY VOLTAGE

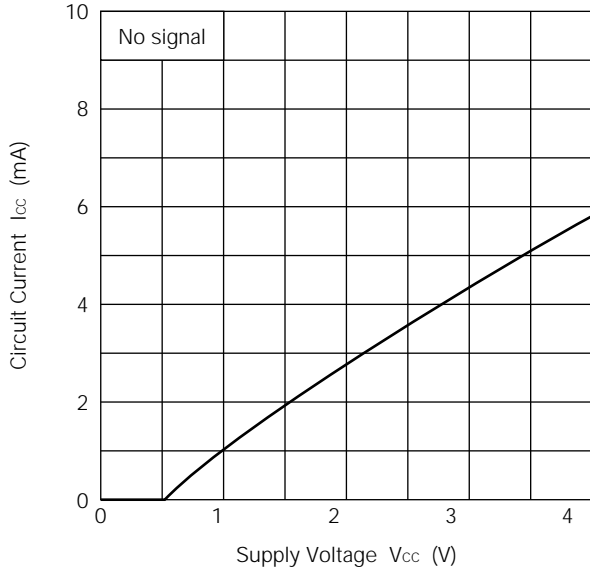

CIRCUIT CURRENT vs. OPERATING TEMPERATURE

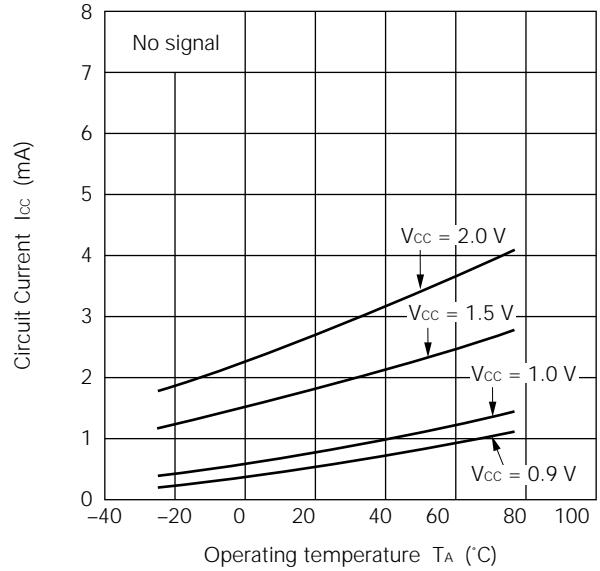

RF FREQUENCY vs. CONVERSION GAIN

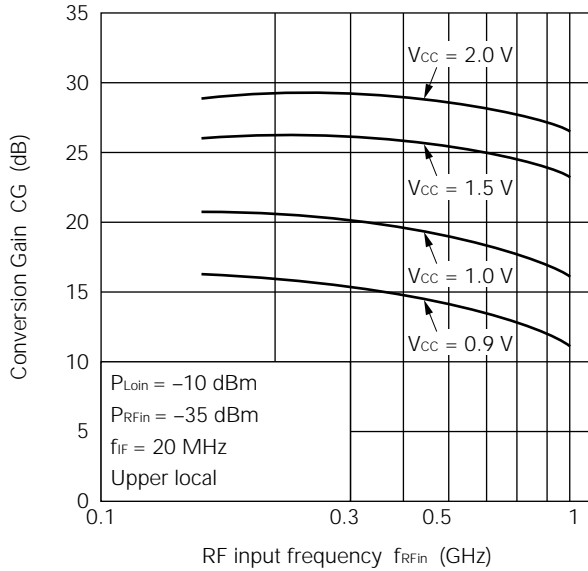

RF FREQUENCY vs. CONVERSION GAIN

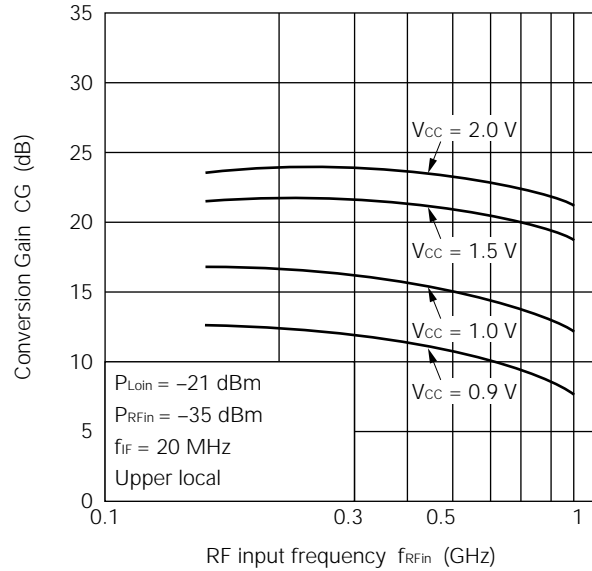



—  $\mu$ PC8103T —

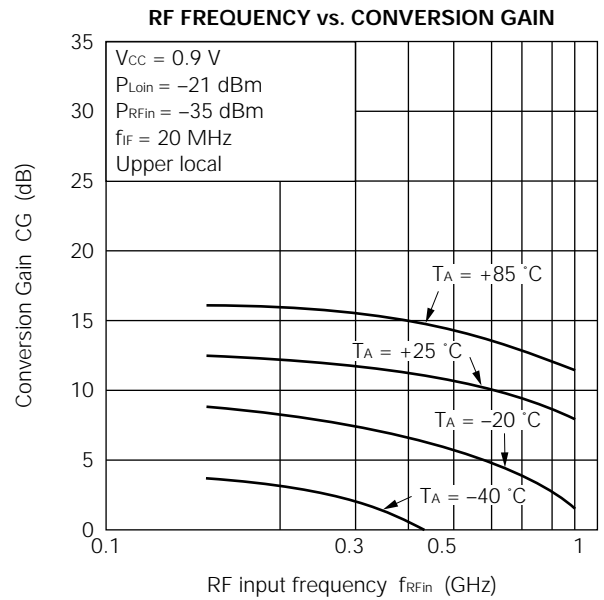
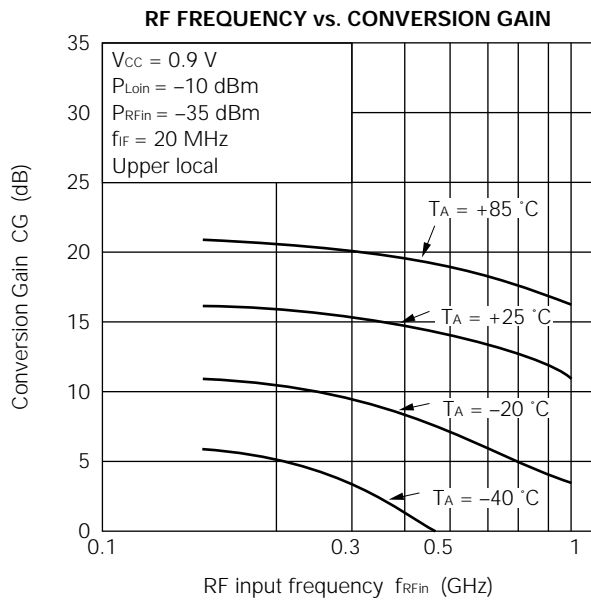
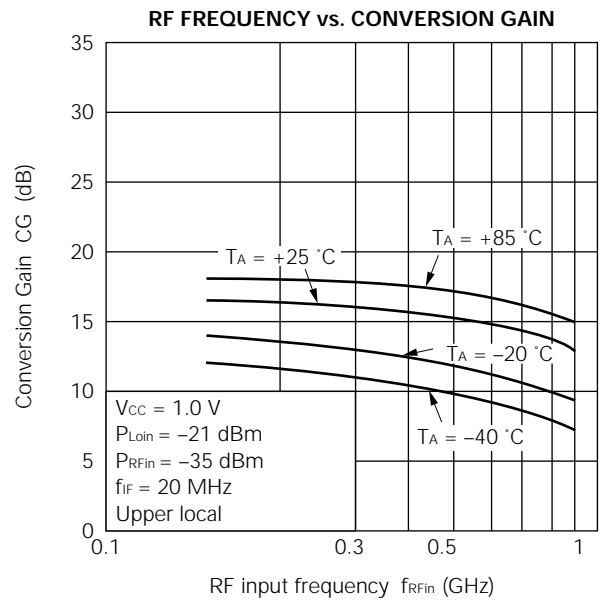
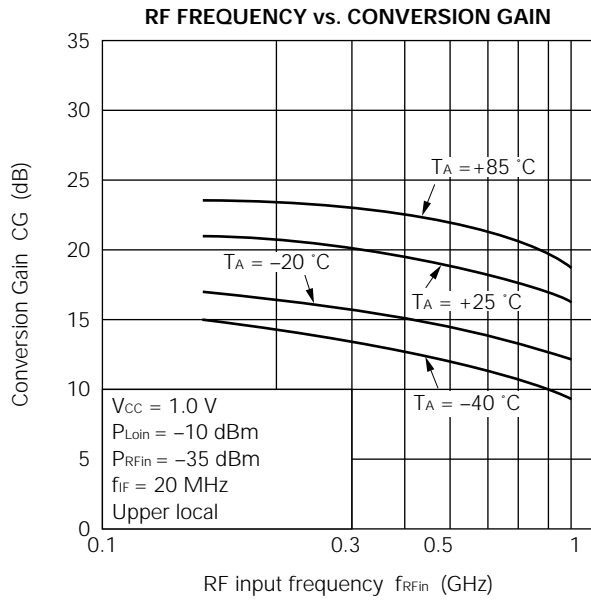

—  $\mu$ PC8103T —

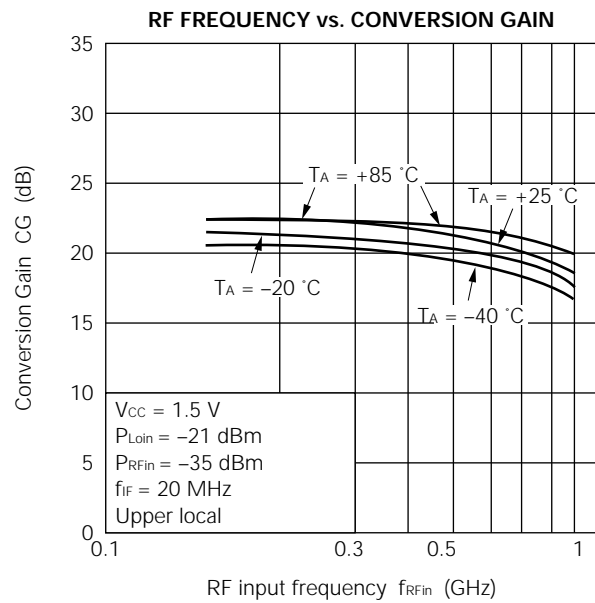
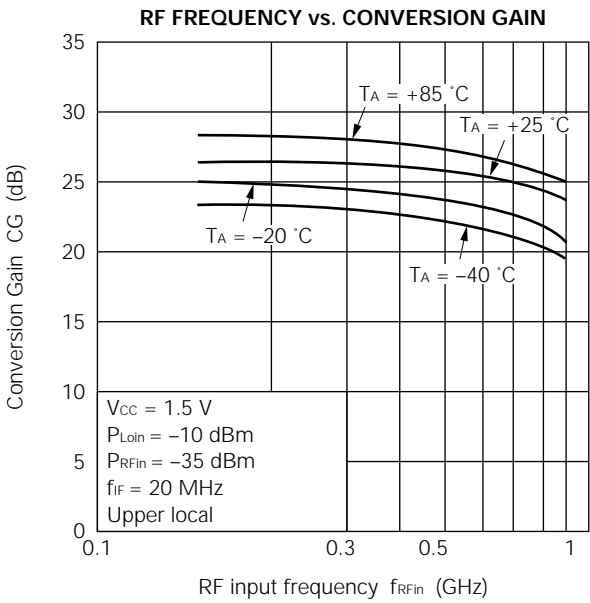
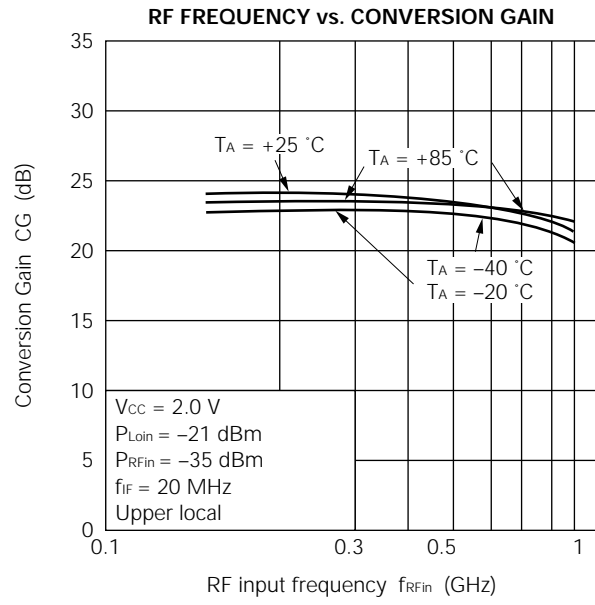
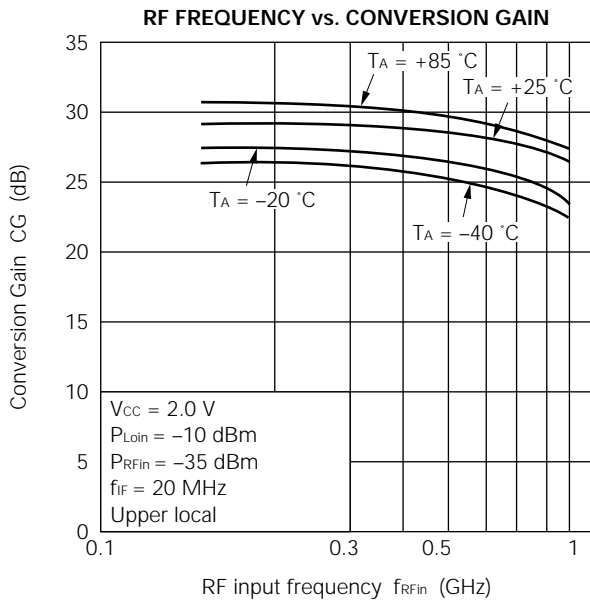

—  $\mu$ PC8103T —

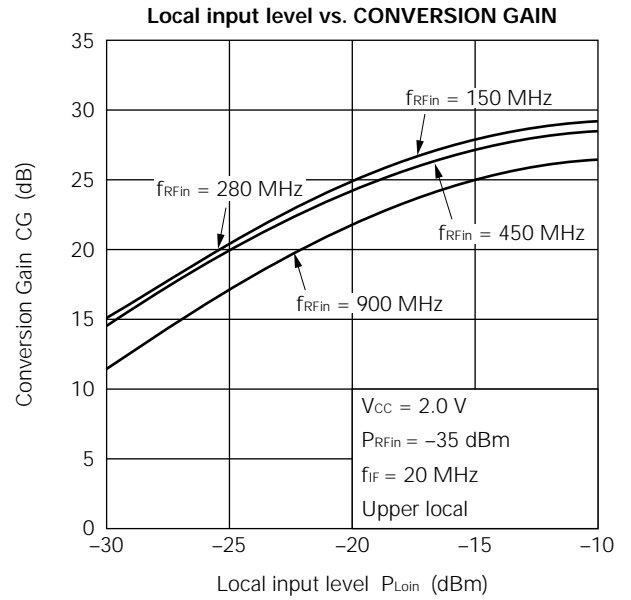
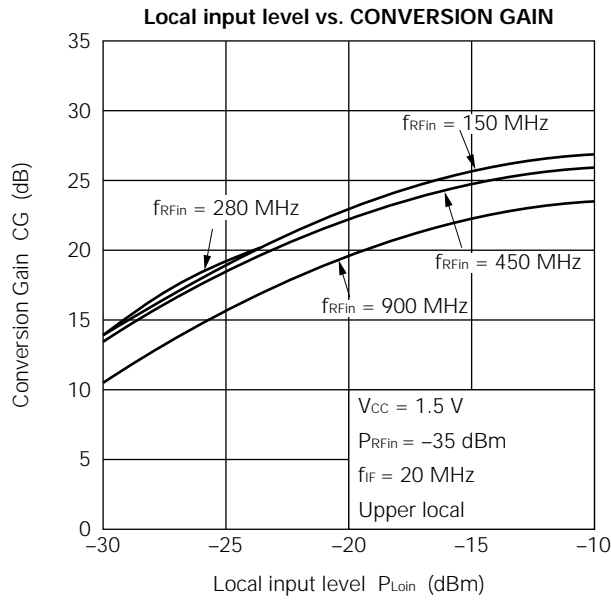
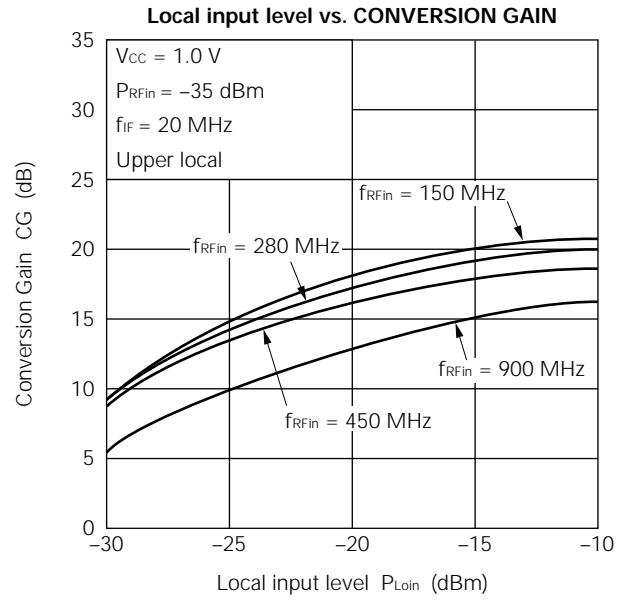
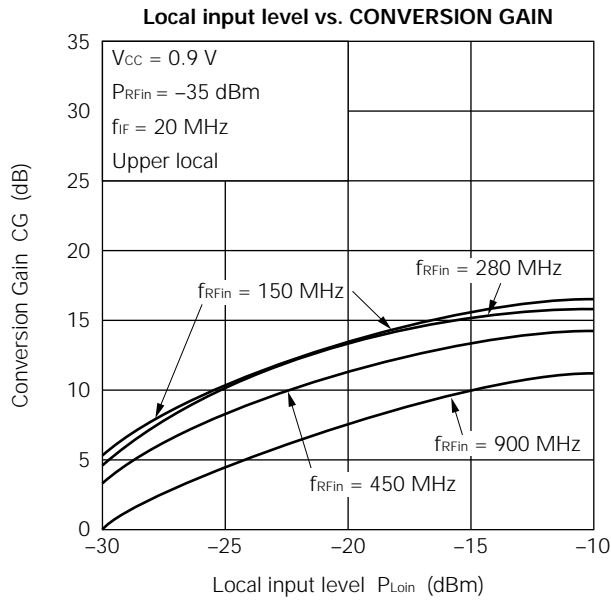

—  $\mu$ PC8103T —

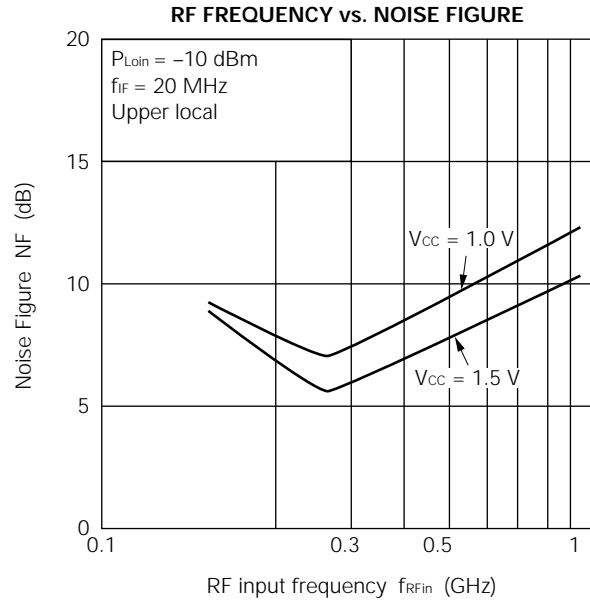
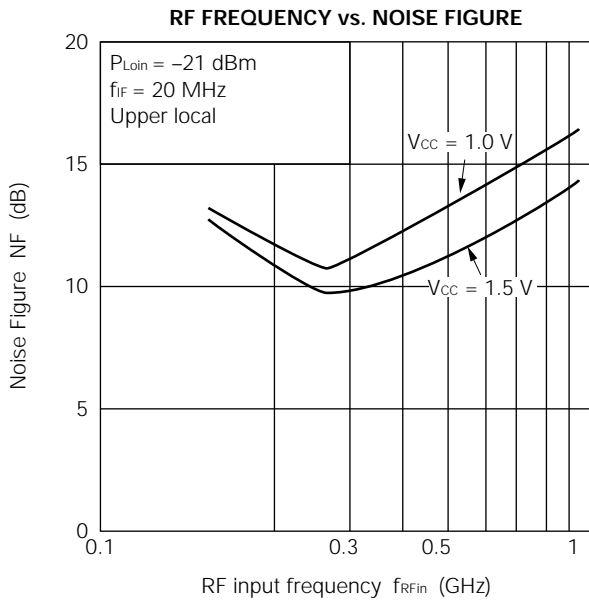
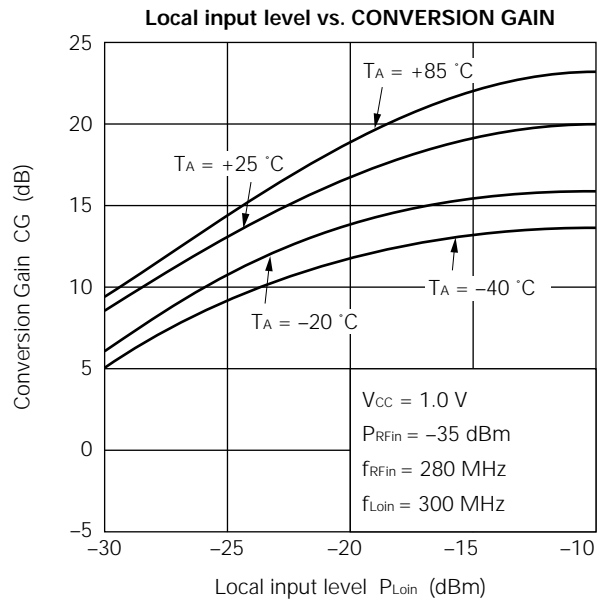
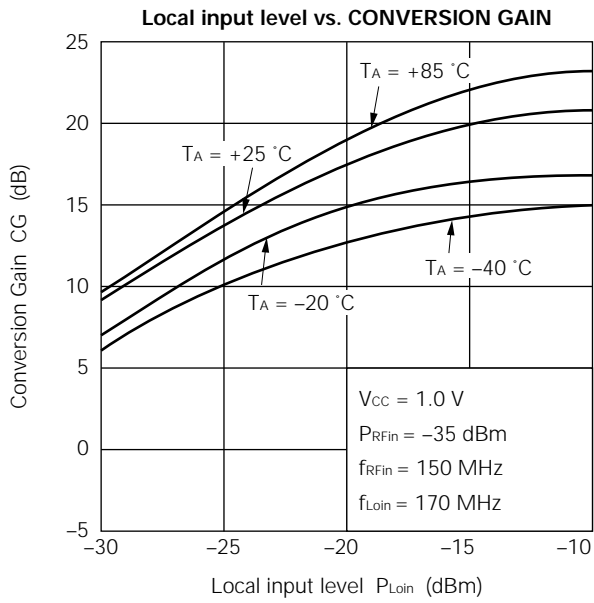

—  $\mu$ PC8103T —

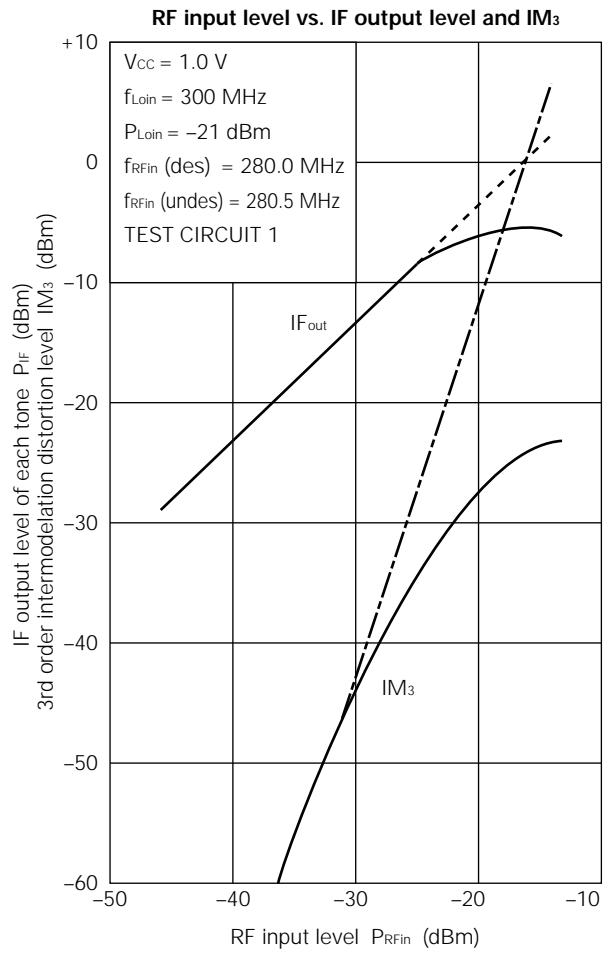
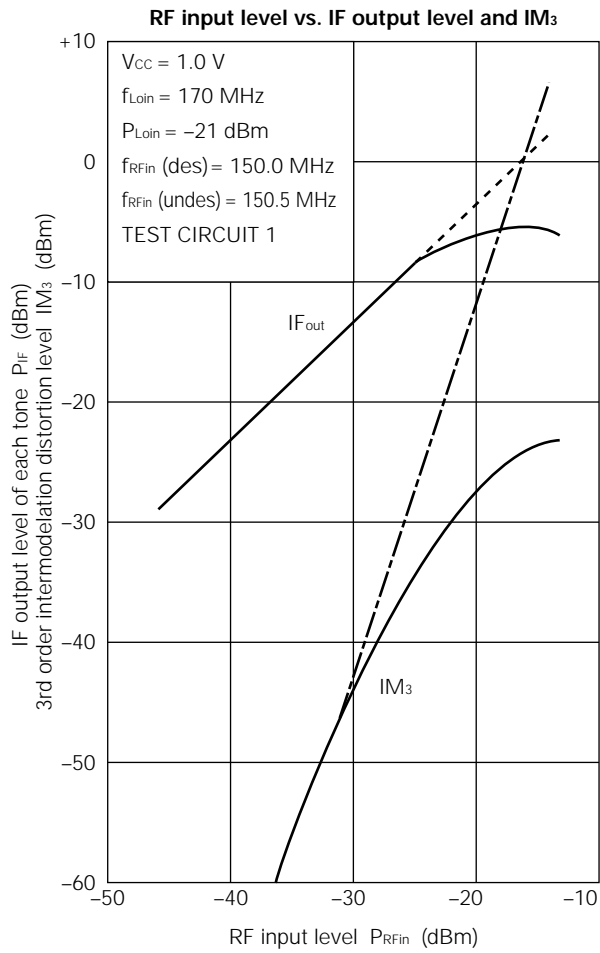

—  $\mu$ PC8108T —

CIRCUIT CURRENT vs. SUPPLY VOLTAGE

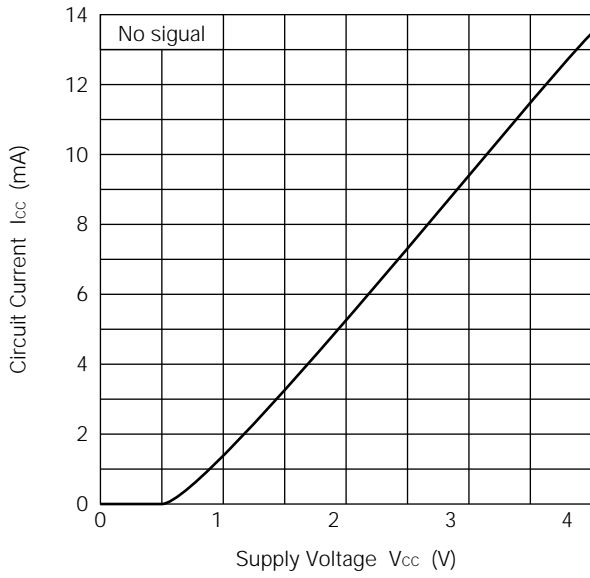

CIRCUIT CURRENT vs. OPERATING TEMPERATURE

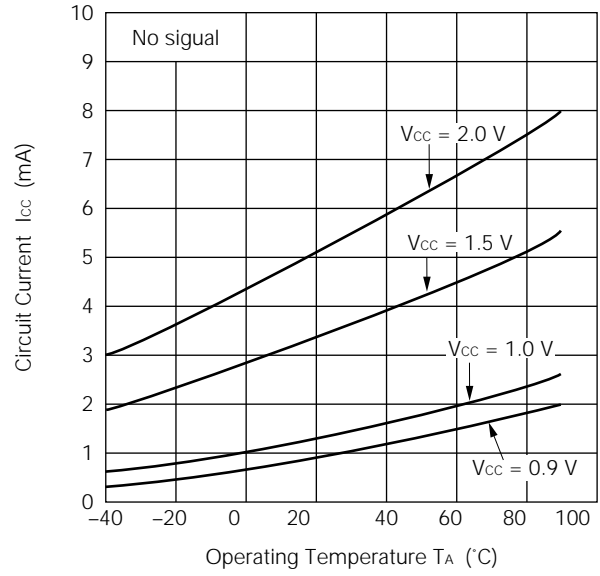

RF FREQUENCY vs. CONVERSION GAIN

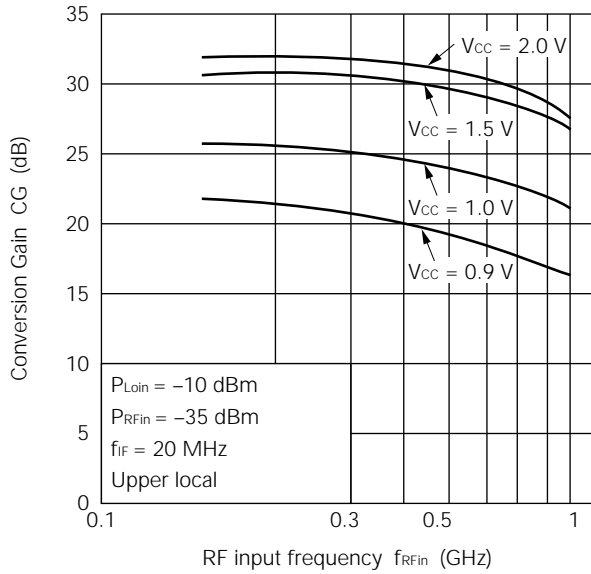

RF FREQUENCY vs. CONVERSION GAIN

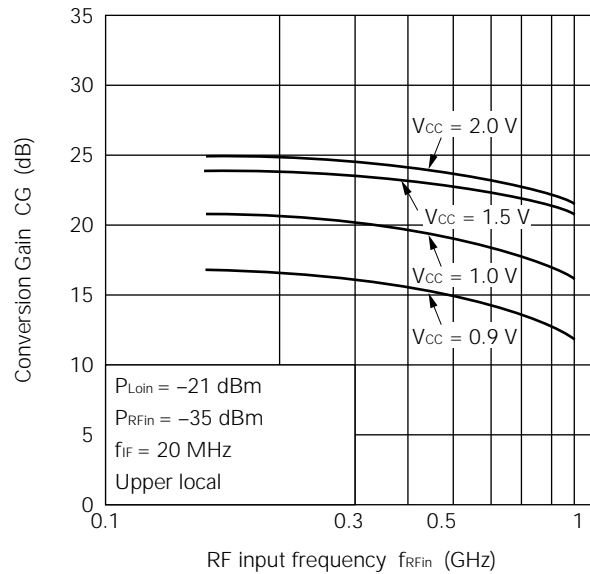

—  $\mu$ PC8108T —

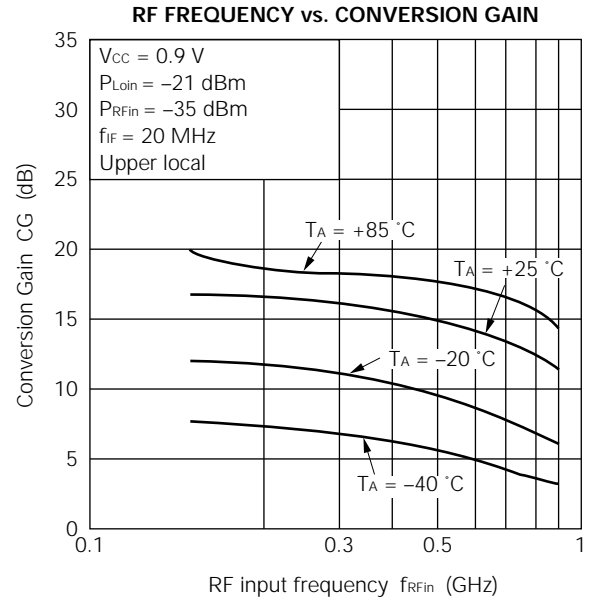
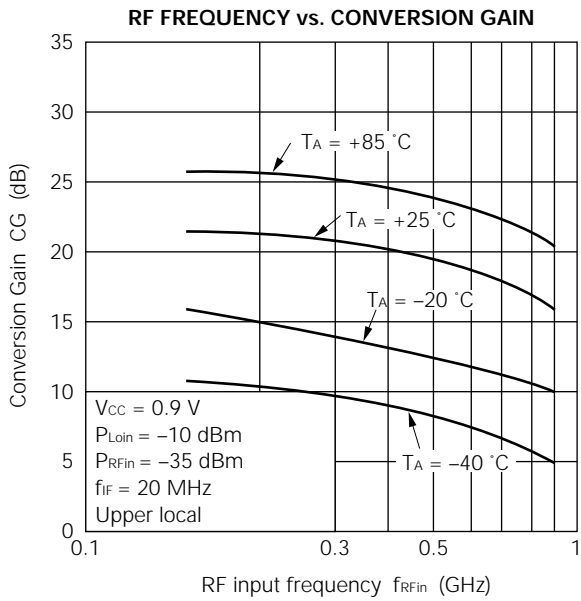
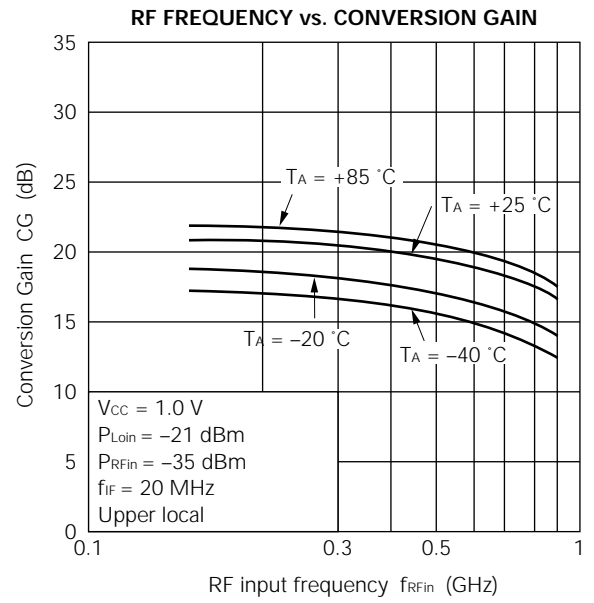
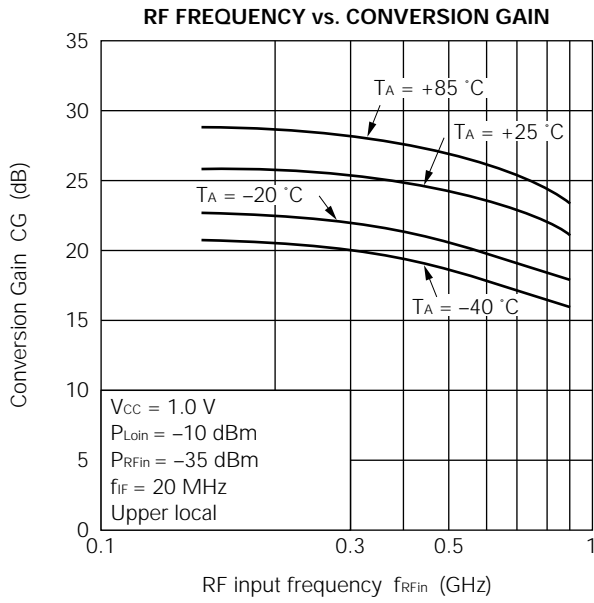

—  $\mu$ PC8108T —

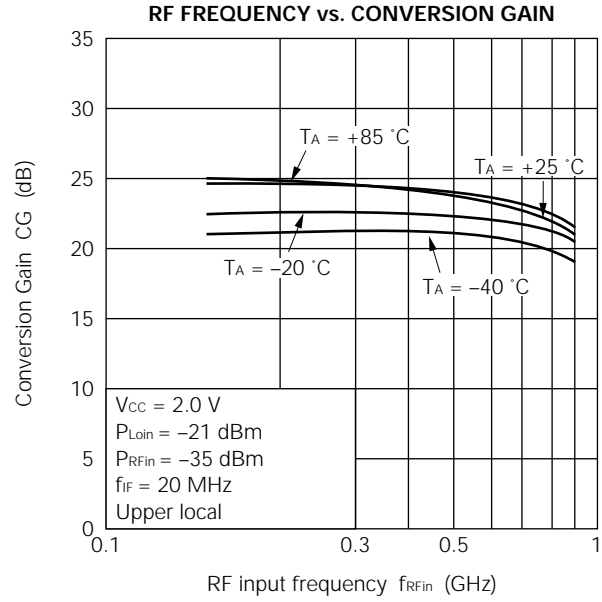
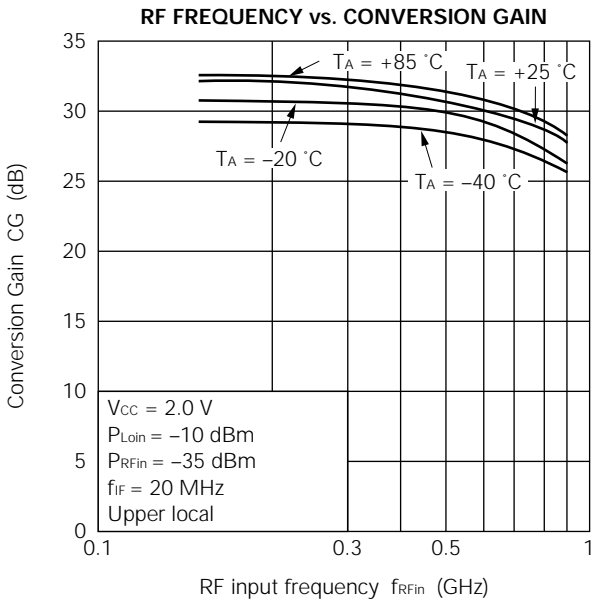
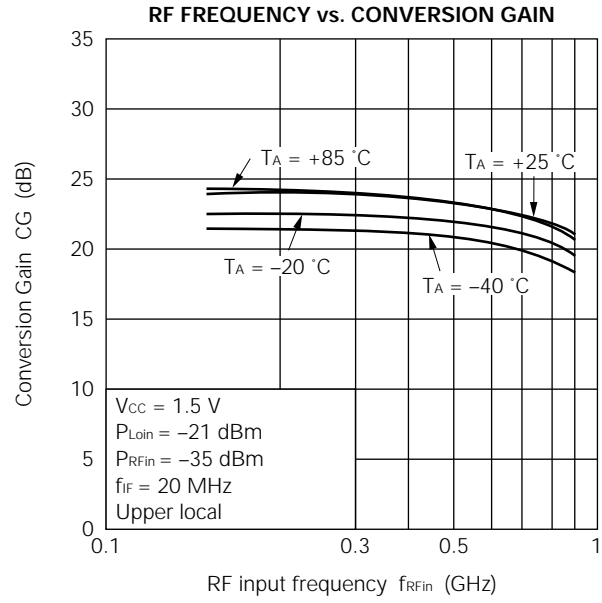
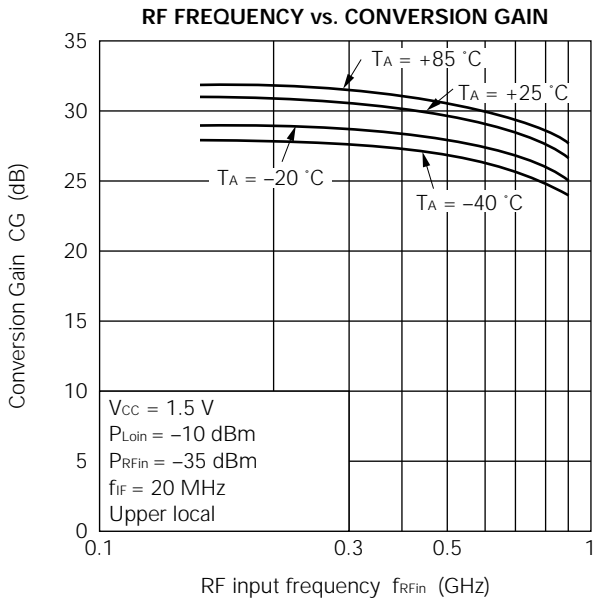



—  $\mu$ PC8108T —

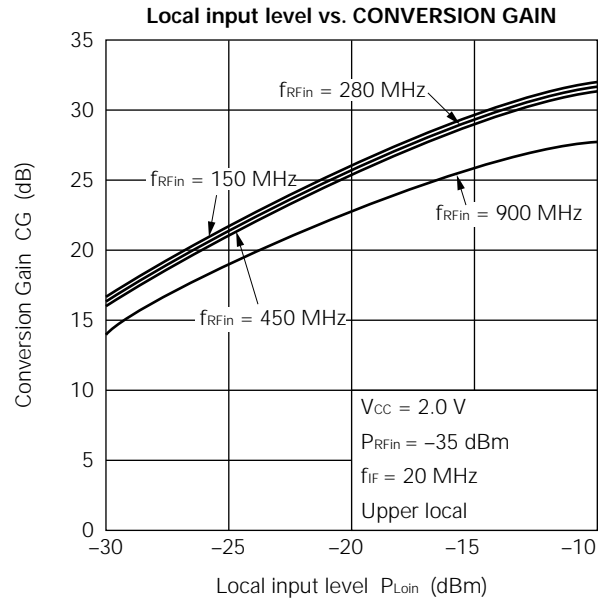
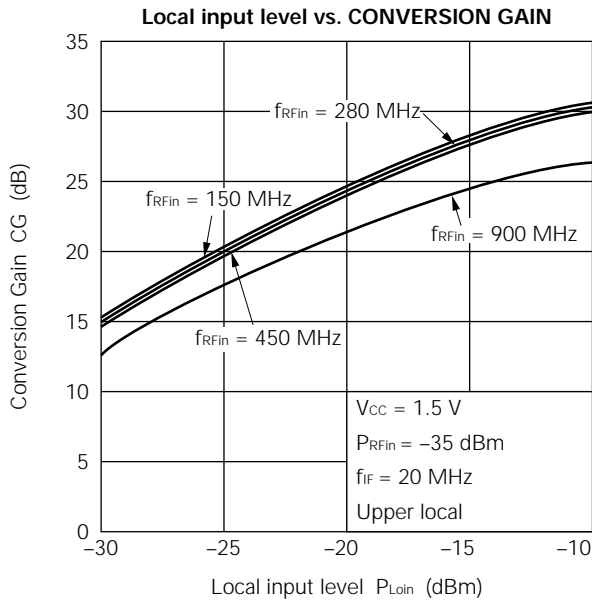
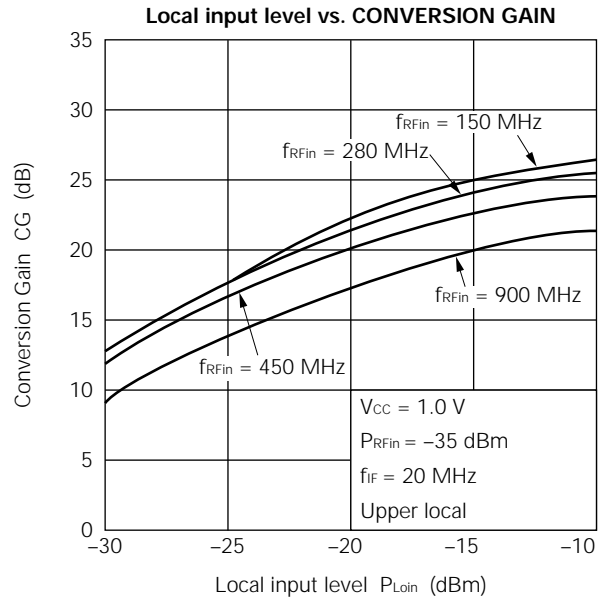
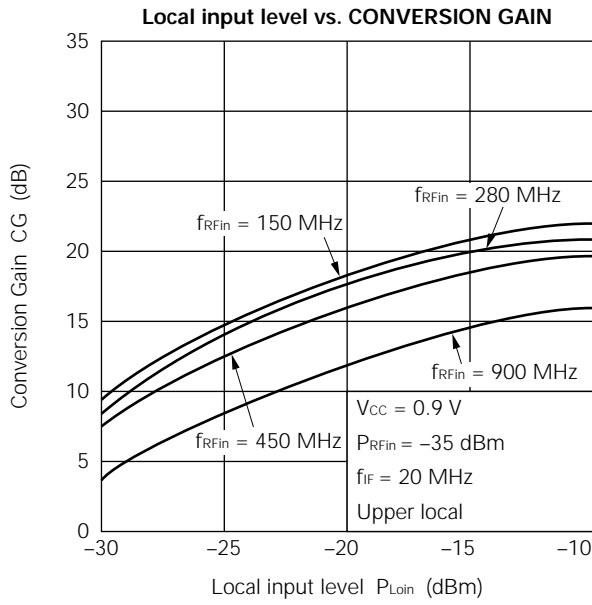

—  $\mu$ PC8108T —

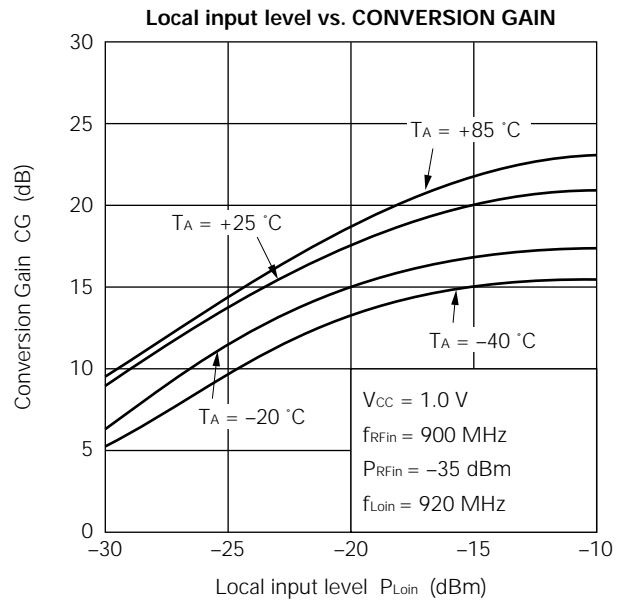
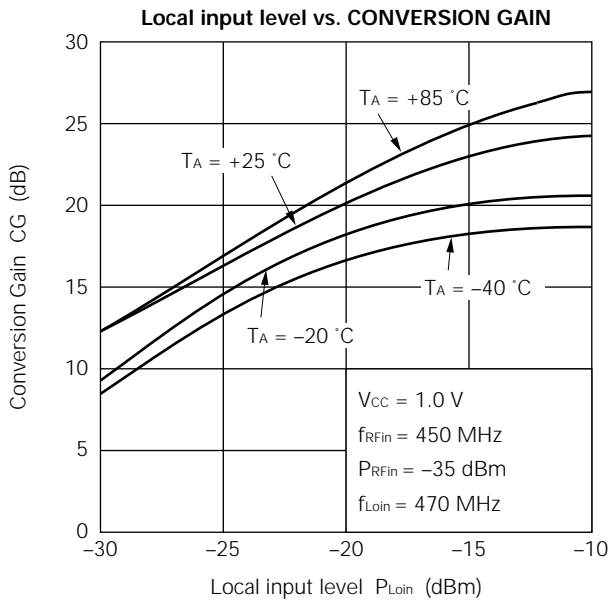
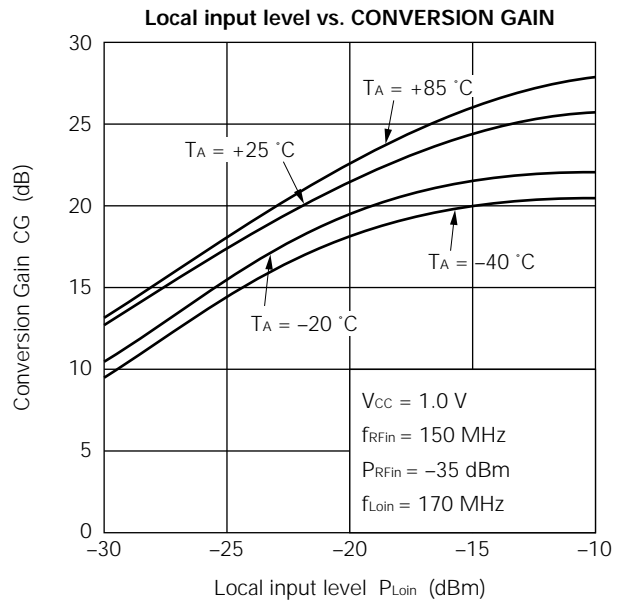
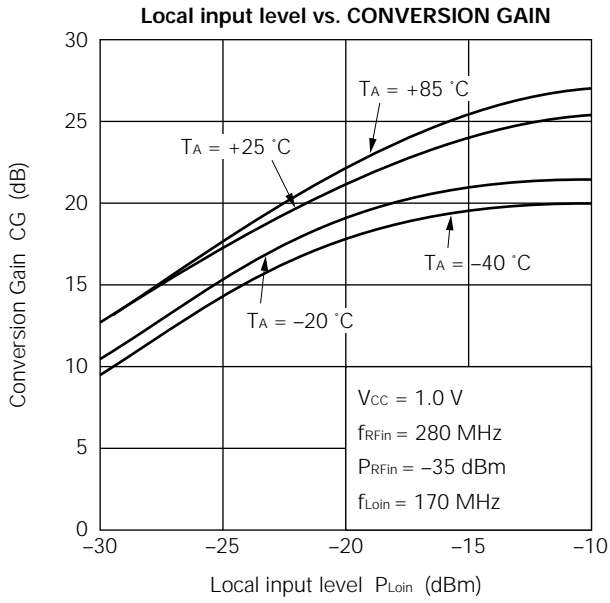

—  $\mu$ PC8108T —

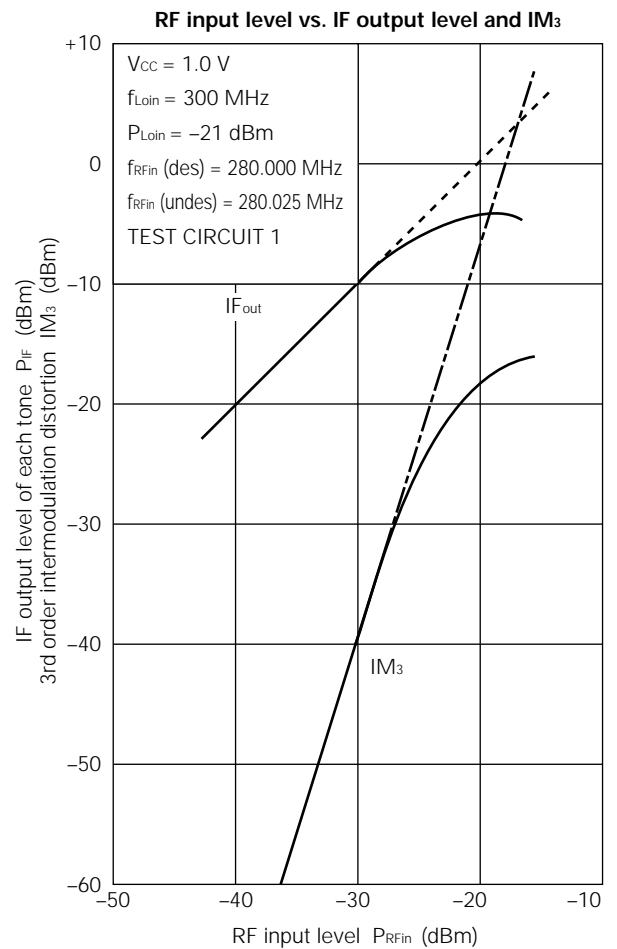
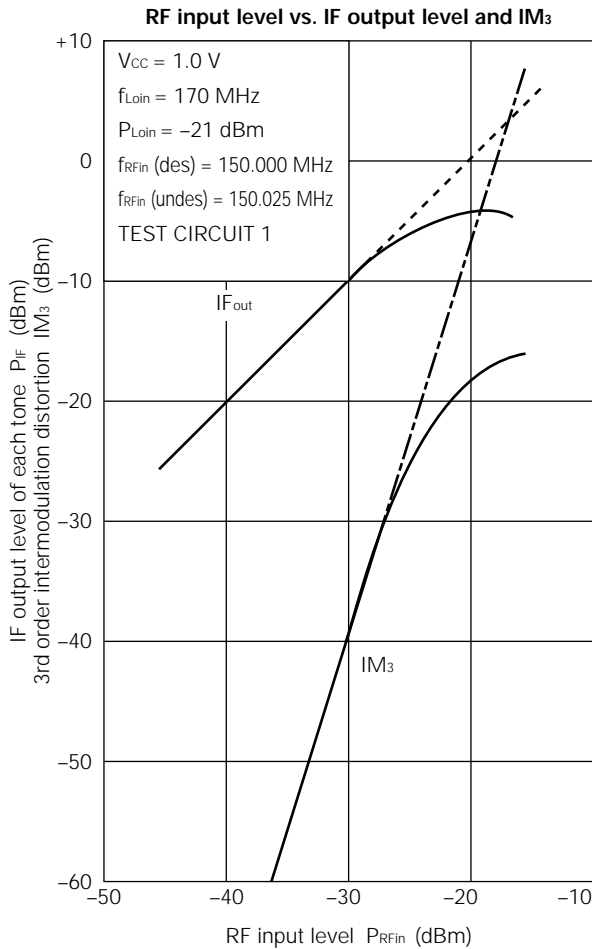
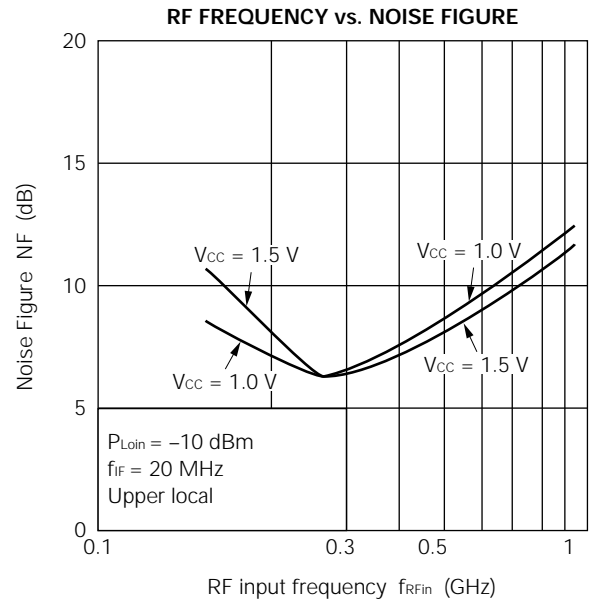
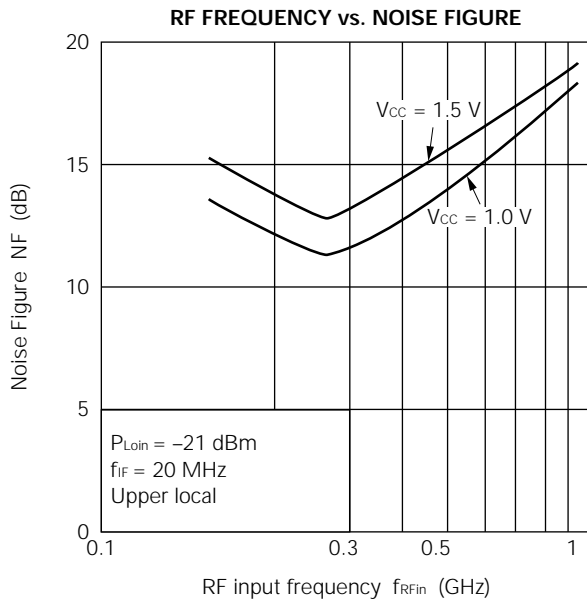

—  $\mu$ PC8108T —

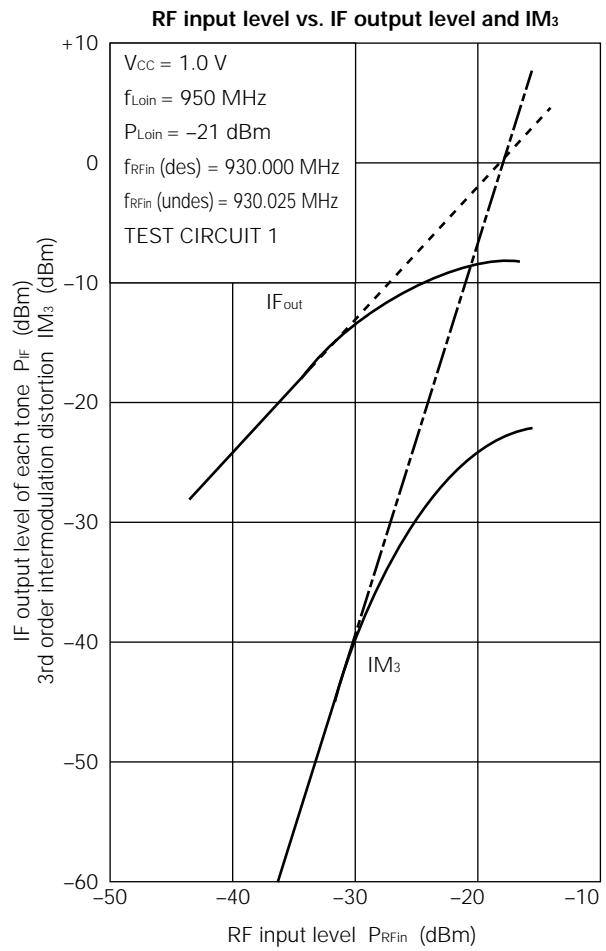
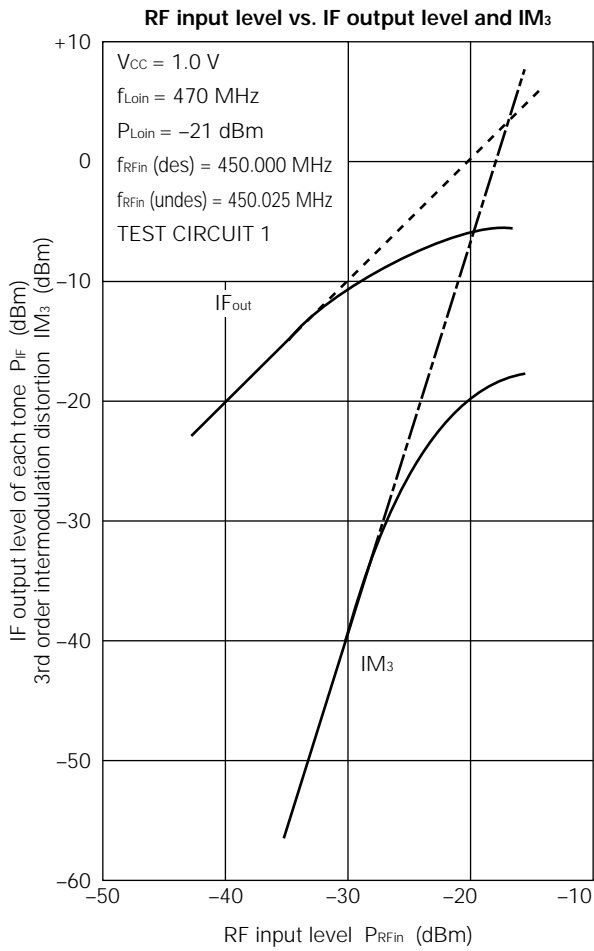

Application circuit example (In the case of  $\mu$ PC8103T)

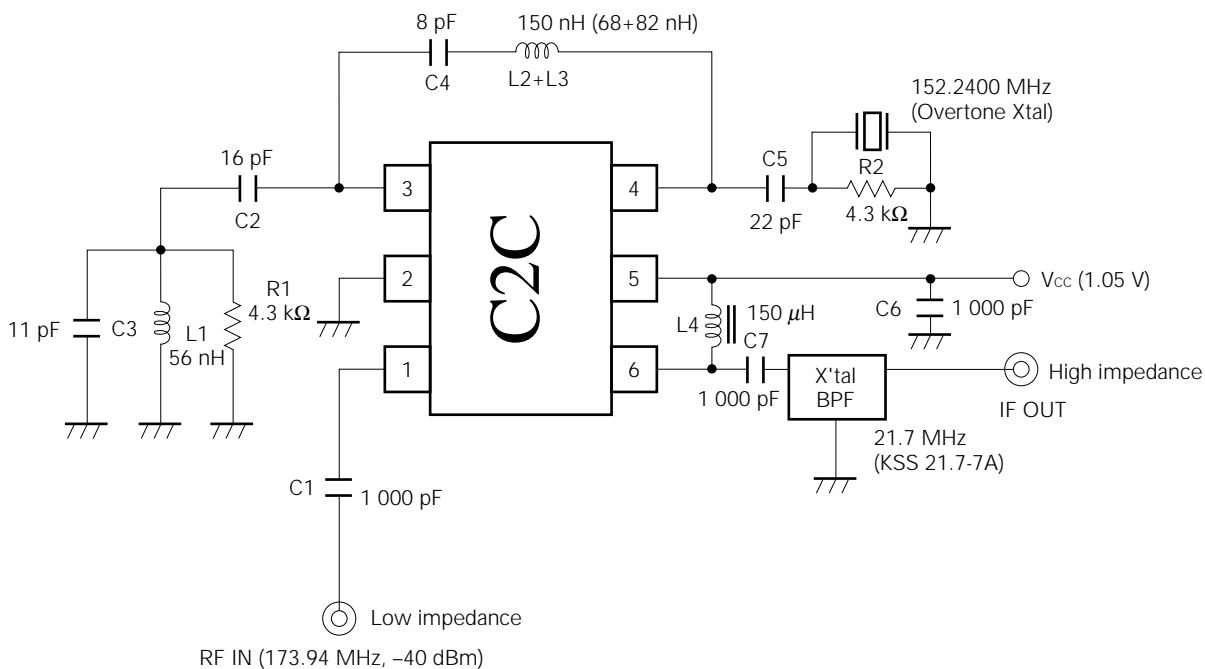
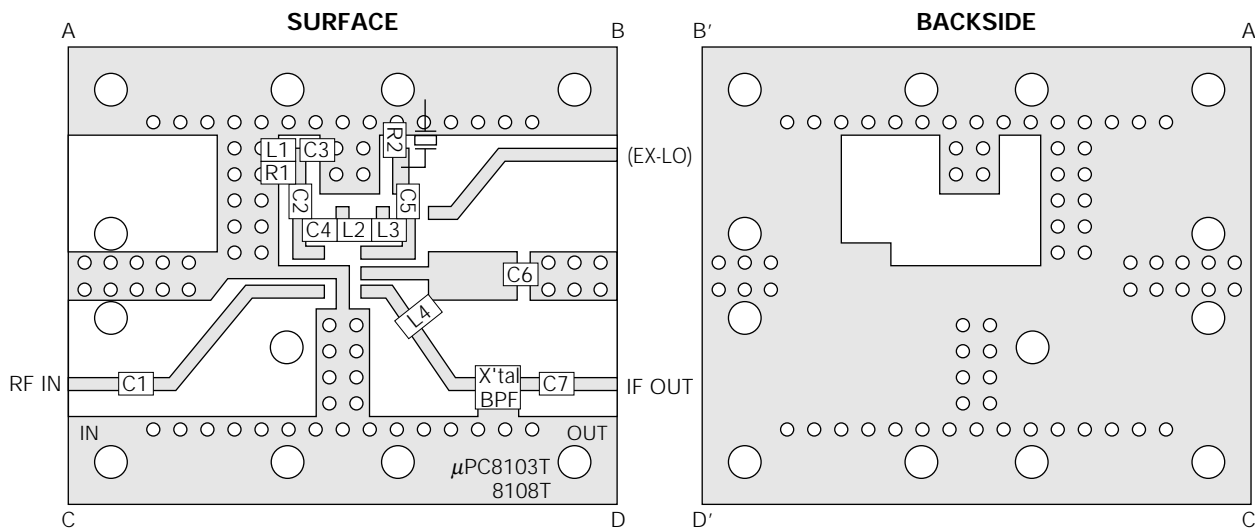

ILLUSTRATION OF APPLICATION CIRCUIT ASSEMBLED ON EVALUATION BOARD



- Note** (\*1) 35 × 42 × 0.4 mm double copper clad polyimide board
- (\*2) Solder plated pattern
- (\*3) Surface vs. Backside : A - A', B - B', C - C', D - D'
- (\*4) ○ ○ : Through holes

The application circuits and their parameters are for references only and are not intended for use in actual design-in's.

— With application circuit ( $\mu$ PC8103T) —

RF input level vs. IF output level

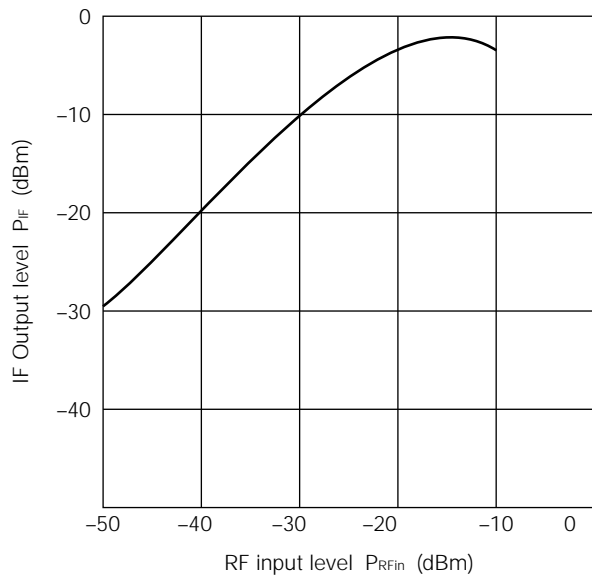

(This measurement needs the calculation as same as TEST CIRCUIT 1.)

Spectrum of Overtone Oscillation (without RF signal)

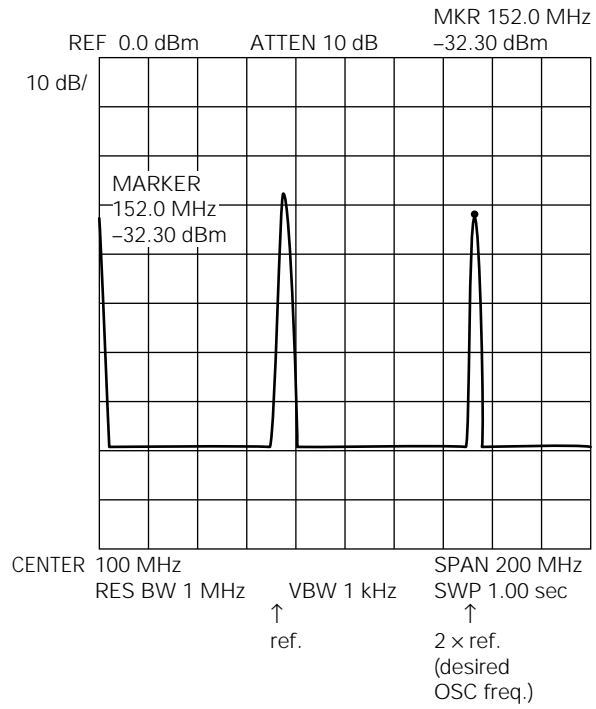

6 PIN MINI MOLD PACKAGE DIMENSIONS (Unit : mm)

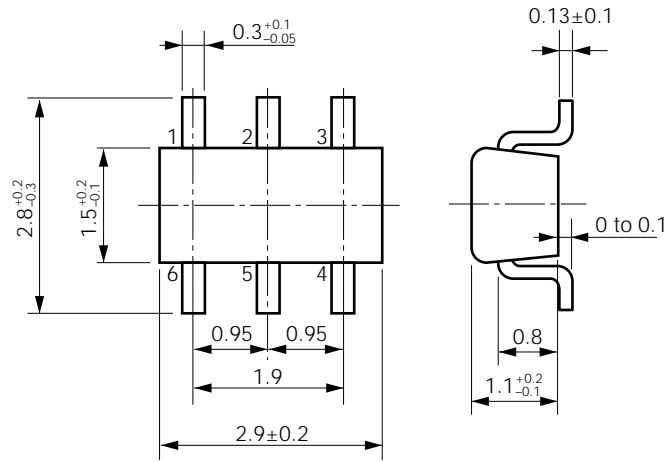

**NOTES ON CORRECT USE**

- (1) Observe precautions for handling because of electro-static sensitive devices.
- (2) Form a ground pattern as wide as possible to maintain the minimum ground impedance (to prevent undesired oscillation).
- (3) Keep the wiring length of the ground pins as short as possible.
- (4) Connect a bypass capacitor (eg 1 000 pF) to the Vcc pin.
- (5) Insert the inductor (eg L = 150 μH) between 5 and 6 pins.

**RECOMMENDED SOLDERING CONDITIONS**

This product should be soldered in the following recommended conditions. Other soldering methods and conditions than the recommended conditions are to be consulted with our sales representatives.

μPC8103T, μPC8108T

Soldering process	Soldering conditions	Recommended condition symbol
Infrared ray reflow	Package peak temperature: 235 °C, Hour: within 30 s. (more than 210 °C), Time: 2 time, Limited days: no. <sup>Note</sup>	IR35-00-2
VPS	Package peak temperature: 215 °C, Hour: within 40 s. (more than 200 °C), Time: 2 time, Limited days: no. <sup>Note</sup>	VP15-00-2
Wave soldering	Soldering tub temperature: less than 260 °C, Hour: within 10 s. Time: 1 time, Limited days: no. <sup>Note</sup>	WS60-00-1
Pin part heating	Pin area temperature: less than 300 °C, Hour: within 10 s. Limited days: no. <sup>Note</sup>	

**Note** It is the storage days after opening a dry pack, the storage conditions are 25 °C, less than 65 % RH.

**Caution** The combined use of soldering method is to be avoided (However, except the pin area heating method).

For details of recommended soldering conditions for surface mounting, refer to information document SEMICONDUCTOR DEVICE MOUNTING TECHNOLOGY MANUAL (IEI-1207)



[MEMO]

## [MEMO]

No part of this document may be copied or reproduced in any form or by any means without the prior written consent of NEC Corporation. NEC Corporation assumes no responsibility for any errors which may appear in this document.

NEC Corporation does not assume any liability for infringement of patents, copyrights or other intellectual property rights of third parties by or arising from use of a device described herein or any other liability arising from use of such device. No license, either express, implied or otherwise, is granted under any patents, copyrights or other intellectual property rights of NEC Corporation or others.

While NEC Corporation has been making continuous effort to enhance the reliability of its semiconductor devices, the possibility of defects cannot be eliminated entirely. To minimize risks of damage or injury to persons or property arising from a defect in an NEC semiconductor device, customer must incorporate sufficient safety measures in its design, such as redundancy, fire-containment, and anti-failure features.

NEC devices are classified into the following three quality grades:

"Standard", "Special", and "Specific". The Specific quality grade applies only to devices developed based on a customer designated "quality assurance program" for a specific application. The recommended applications of a device depend on its quality grade, as indicated below. Customers must check the quality grade of each device before using it in a particular application.

Standard: Computers, office equipment, communications equipment, test and measurement equipment, audio and visual equipment, home electronic appliances, machine tools, personal electronic equipment and industrial robots

Special: Transportation equipment (automobiles, trains, ships, etc.), traffic control systems, anti-disaster systems, anti-crime systems, safety equipment and medical equipment (not specifically designed for life support)

Specific: Aircrafts, aerospace equipment, submersible repeaters, nuclear reactor control systems, life support systems or medical equipment for life support, etc.

The quality grade of NEC devices in "Standard" unless otherwise specified in NEC's Data Sheets or Data Books. If customers intend to use NEC devices for applications other than those specified for Standard quality grade, they should contact NEC Sales Representative in advance.

Anti-radioactive design is not implemented in this product.

M4 94.11

**NESAT (NEC Silicon Advanced Technology) is a trademark of NEC Corporation.**