

BIPOLAR ANALOG INTEGRATED CIRCUIT

μ PC8126GR

900 MHz BAND DIRECT QUADRATURE MODULATOR IC FOR DIGITAL MOBILE COMMUNICATION

DESCRIPTION

The μ PC8126GR is a silicon monolithic integrated circuit designed as 900 MHz band direct quadrature modulator for digital mobile communication systems. This Si-MMIC consists of pre-mixer for RF and IF local oscillator and 900 MHz band quadrature modulator which are packaged in 20 pin SSOP. The device has power save function and can operate 2.7 V to 3.6 V supply voltage. Therefore, it can contribute to make RF block small, high performance and low power consumption.

FEATURES

- Direct modulation range : 915 MHz to 960 MHz
- Pre-mixer for RF and IF local oscillator is incorporated.
- External local filter can be applied between pre-mixer output and modulator input port.
- Low operation current : $I_{cc} = 35 \text{ mA (typ.) @ } V_{cc} = 3 \text{ V}$
- Equipped with power save function.
- 20 pin SSOP suitable for high density surface mounting.

APPLICATIONS

- Digital cellular phones (PDC900 MHz etc.)

ORDERING INFORMATION

PART NUMBER	PACKAGE	SUPPLYING FORM	QUANTITY
μ PC8126GR-E1	20 pin plastic SSOP (225 mil)	Embossed tape, 12 mm wide. Pins 1 through 10 are in tape pull-out direction.	2500 pcs/Reel

To order evaluation samples, please contact your local NEC sales office.

(Part number for sample order: μ PC8126GR, Quantity: 20 pcs/Unit)

Caution electro-static sensitive devices.

The information in this document is subject to change without notice. Before using this document, please confirm that this is the latest version.

Not all devices/types available in every country. Please check with local NEC representative for availability and additional information.

INTERNAL BLOCK DIAGRAM AND PIN CONNECTIONS (Top View)

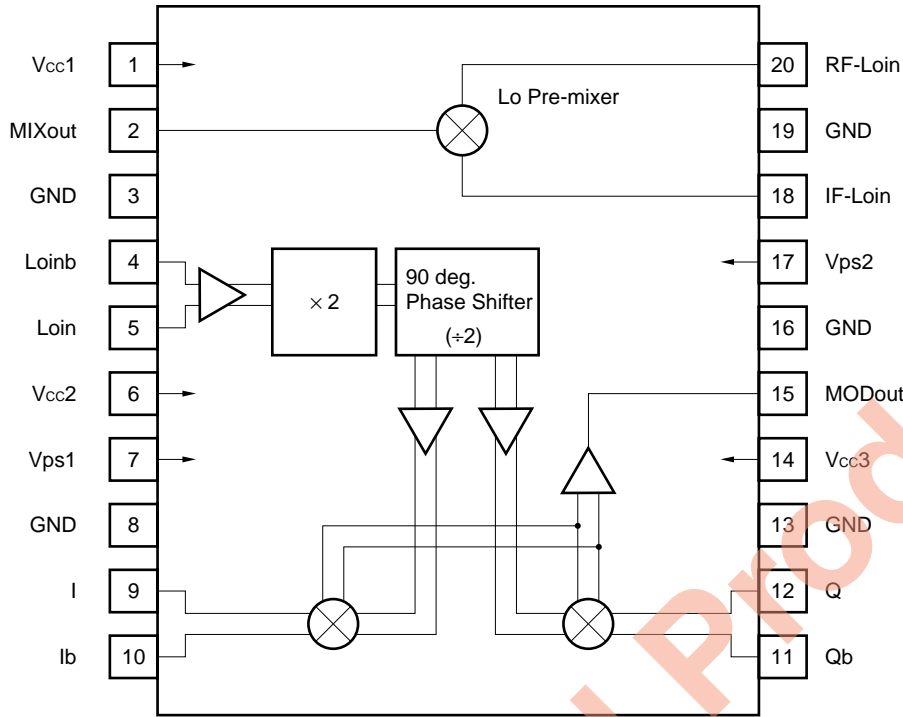

★ QUADRATURE MODULATOR SERIES PRODUCT

Part Number	Functions	I _{cc} (mA)	f _{LOin} (MHz)	f _{MODout} (MHz)	RF Mixer f _{RFout} (MHz)	Phase Shifter	Package	Application
μPC8101GR	150 MHz Quad.Mod	15/@2.7 V	100 to 300	50 to 150	External	F/F	20-pin SSOP (225 mil)	CT-2 etc.
μPC8104GR	RF Up-Converter + IF Quad.Mod	28/@3.0 V	100 to 400		900 to 1 900	Doubler + F/F	20-pin SSOP (225 mil)	Digital Comm.
μPC8105GR	400 MHz Quad.Mod	16/@3.0 V	100 to 400		External		16-pin SSOP (225 mil)	
μPC8110GR	1 GHz Direct Quad.Mod	24/@3.0 V	800 to 1 000		External		20-pin SSOP (225 mil)	PDC800 MHz, etc.
μPC8125GR	RF Up-Converter + IF Quad.Mod + AGC	36/@3.0 V	220 to 270		1 800 to 2 000			PHS
μPC8126GR	900 MHz Direct Quad.Mod with Offset-Mixer	35/@3.0 V	915 to 960		915 to 960			PDC800 MHz
μPC8126K			889 to 960	889 to 960	28-pin QFN			
μPC8129GR	×2LO IF Quad. Mod+RF Up-Converter	28/@3.0 V	200 to 800	100 to 400	800 to 1 900	F/F	20-pin SSOP (225 mil)	GSM, DCS1800, etc.
μPC8139GR-7JH	Transceiver IC (1.9 GHz Indirect Quad. Mod + RX-IF + IF VCO)	TX: 32.5 RX: 4.8 /@3.0 V	220 to 270		1 800 to 2 000	CR	30-pin TSSOP (225 mil)	PHS
μPC8158K	RF Up-Converter + IF Quad.Mod + AGC	28/@3.0 V	100 to 300		800 to 1 500		28-pin QFN	PDC800 M/1.5 G

Remark As for detail information of series products, please refer to each data sheet.

APPLICATION EXAMPLE

[PDC800MHz]

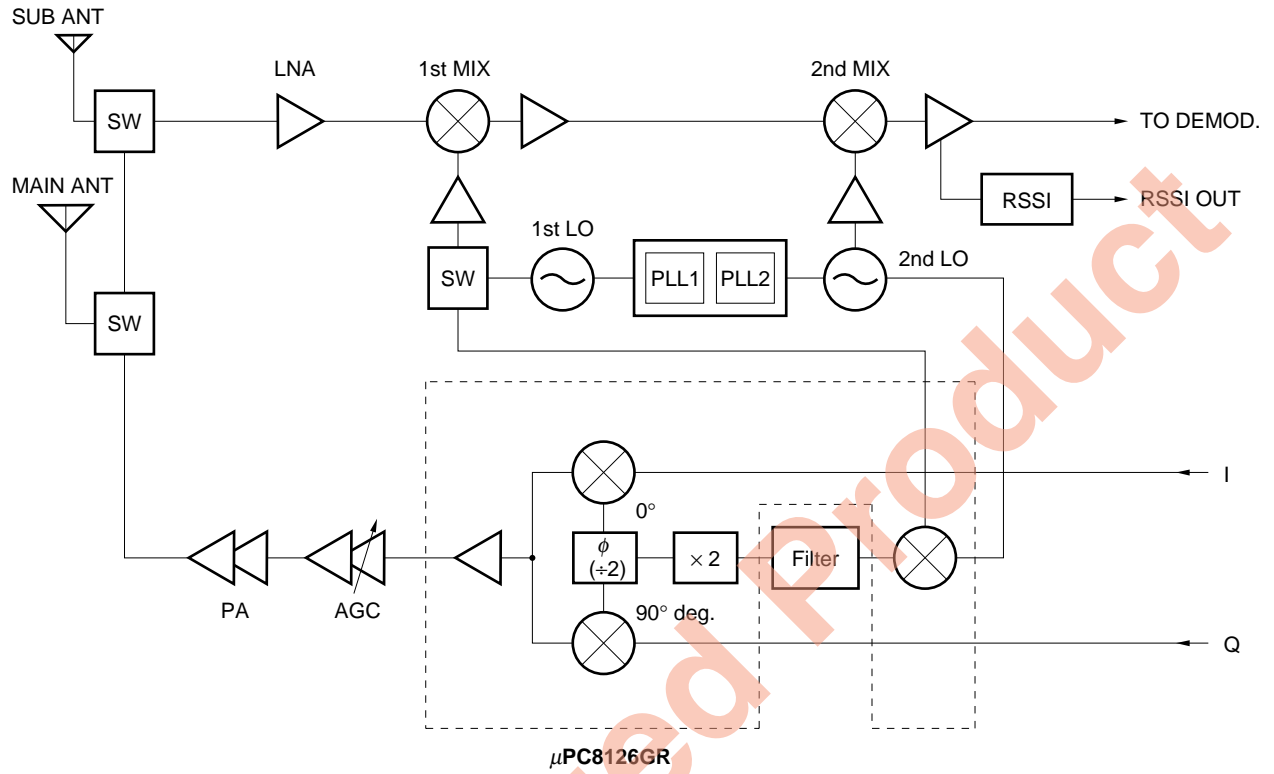

Discontinued Product

ABSOLUTE MAXIMUM RATINGS

PARAMETER	SYMBOL	RATING	UNIT	TEST CONDITIONS
Supply voltage	V _{CC}	4.0	V	T _A = +25 °C, 1, 6, 14 pin
Power Save Control Voltage	V _{ps}	4.0	V	T _A = +25 °C, 7, 17 pin
Power Dissipation	P _D	430 ^{Note 1}	mW	T _A = +85 °C
Operating Ambient Temperature	T _A	-40 to +85	°C	
Storage Temperature	T _{stg}	-55 to +150	°C	

Note 1. Mounted on a 50 × 50 × 1.6 mm double copper clad epoxy glass PWB.

RECOMMENDED OPERATING CONDITIONS

PARAMETER	SYMBOL	MIN.	TYP.	MAX.	UNIT	TEST CONDITIONS
Supply Voltage	V _{CC}	2.7	3.0	3.6	V	
Operating Ambient Temperature	T _A	-25	+25	+75	C	
Pre-Mix. RF Input Frequency	f _{RFIn}	700		1200	MHz	P _{RFIn} = -11 dBm
Pre-Mix. RF Input Power	P _{RFIn}	-13	-11	-9	dBm	
Pre-Mix. IF Input Frequency	f _{IFIn}	120	135	270	MHz	P (f _{IFIn} × 7) ≤ -65 dBc P _{IFIn} = -12 dBm
Pre-Mix. IF Input Power	P _{IFIn}	-14	-12	-10	dBm	
Pre-Mix. Output Frequency	f _{MIXout}	915		960	MHz	
Modulator Output Frequency	f _{MODout}	915		960	MHz	
Modulator Lo Input Frequency	f _{LoIn}					
Modulator Lo Input Power	P _{LoIn}	-22.5	-18.5	-14.5	dBm	
I/Q Input Frequency	f _{I/QIn}	DC		10	MHz	
I/Q Input Amplitude	V _{I/QIn}			500	mV _{p-p}	Single ended Input
				250		Differential Input

ELECTRICAL CHARACTERISTICS

(T_A = +25 °C, V_{cc1} = V_{cc2} = V_{cc3} = 3.0 V, V_{ps1}, V_{ps2} ≥ 2.2 V Unless Otherwise Specified)

PARAMETER		SYMBOL	MIN.	TYP.	MAX.	UNIT	TEST CONDITIONS
MODULATOR + PRE-MIXER TOTAL (TEST CIRCUIT 1)							
Total Circuit Current		I _{CC} (TOTAL)	24	35	44	mA	No Input signals
Total Circuit Current at Sleep Mode		I _{CC (ps)} TOTAL		0	15	μA	V _{ps} ≤ 0.5 V (Low), No Input Signals
Modulator Output Power		P _{MODout}	-12	-9	-6	dBm	f _{IFin} = 135 MHz, P _{IFin} = -12 dBm f _{RFin} = 813 MHz, P _{RFin} = -11 dBm
Local Oscillator Leakage		LoL ^{Note 2}		-35	-30	dBc	f _{MODout} = 948 MHz + f _{I/Q} f _{I/Qin} = 2.625 kHz
Image Rejection		ImR		-40	-30	dBc	V _{I/Qin} = 500 mVp-p (Single ended)
I/Q 3rd Order Intermodulation		IM _{3 (I/Q)}		-45	-30	dBc	I/Q (DC) = I _b /Q _b (DC) = V _{cc} /2 Data Rate: 42 kbps, RNYQ: α = 0.5
f _{IF-Lo} × 7 Harmonics		7f _{IF-Lo}			-65	dBc	MOD Pattern: All Zero
Power Save Response Time	Rise Time	T _{ps} (RISE)		3	5	μs	V _{ps} : Low to High
	Fall Time	T _{ps} (FALL)		3	5	μs	V _{ps} : High to Low
Error Vector Magnitude		EVM		1.6	3.5	%rms	f _{IFin} = 135 MHz, P _{IFin} = -12 dBm f _{RFin} = 813 MHz, P _{RFin} = -11 dBm f _{MODout} = 948 MHz + f _{I/Q} f _{I/Qin} = 2.625 kHz V _{I/Qin} = 500 mVp-p (Single ended)
Adjacent Channel Power		ACP (Δf = ±50 kHz)		-65	-60	dBc	I/Q (DC) = I _b /Q _b (DC) = V _{cc} /2 Data Rate: 42 kbps, RNYQ: α = 0.5 MOD Pattern: PN9
Port Current-7pin		I _{ps} (7 pin)			620	μA	No Input Signals
Port Current-17pin		I _{ps} (17 pin)			400	μA	No Input Signals

Note 2. f_{LoL} = f_{IFin} + f_{RFin}

STANDARD CHARACTERISTICS FOR REFERENCE

(T_A = +25 °C, V_{cc1} = V_{cc2} = V_{cc3} = 3.0 V, V_{ps1}, V_{ps2} ≥ 2.2 V Unless Otherwise Specified)

PARAMETER	SYMBOL	MIN.	TYP.	MAX.	UNIT	TEST CONDITIONS
MODULATOR (TEST CIRCUIT 1)						
Modulator Circuit Current	I _{cc} (MOD)		27.5	34	mA	No Input Signals
Modulator Circuit Current at Sleep Mode	I _{cc} (ps) (MOD)		0	10	μA	V _{ps} ≤ 0.5 V (Low), No Input Signals
Input Impedance I and Q Port	Z _{I/Qin}	90	180		kΩ	f _{I/Q} = DC to 10 MHz
Modulator Output Port VSWR	VSWR (MOD)		1.5 : 1		–	f _{MODout} = 948 MHz
PRE-MIXER (TEST CIRUCIT 2)						
Pre-Mixer Circuit Current	I _{cc} (MIX)		7.5	10	mA	No Input Signals
Pre-Mixer Circuit Current at Sleep Mode	I _{cc} (ps) (MIX)		0	5	μA	V _{ps} ≤ 0.5 V (Low), No Input Signals
Pre-Mixer Conversion Gain	CG (MIX)	–5	–3	–1	dB	f _{RFIn} = 813 MHz, P _{RFIn} = –11 dBm f _{IFin} = 135 MHz, P _{IFin} = –12 dBm
Pre-Mixer Output Power	P _{out} (MIX)	–17	–15	–13	dBm	f _{MIXout} = 948 MHz

Discontinued Product

PIN EXPLANATIONS

Pin No.	Symbol	Supply Vol. (V)	Pin Vol. (V) @3 V	Description	Equivalent Circuit						
1	V _{cc1} (Pre-Mixer)	2.7 to 3.6	–	Supply voltage pin for the pre-mixer. An internal regulator helps keep the device stable against temperature or V _{cc} variation.							
2	Pre-Mixout	2.7 to 3.6	–	Output from the pre-Mixer. This pin is designed as pen collector. Due to the high impedance output, this pin should be externally equipped with LC matching circuit to next stage.							
3	GND (Modulator)	0	–	Ground pin for the modulator. Connect to the ground with minimum inductance. Track length should be kept as short as possible.							
4	LOinb	–	2.6	Bypass of Lo input for modulator. This pin is grounded through around 33 pF capacitor.							
5	LOin	–	2.6	Lo input for the phase shifter. Connect around 300 Ω between pin 4 and 5 to match to 50 Ω by LC.							
6	V _{cc2}	2.7 to 3.6	–	Supply voltage pin for the phase shifter and IQ Mixer. An internal regulator helps keep the device stable against temperature or V _{cc} variation.							
7	V _{ps1} (Modulator)	V _{PS}	–	Power save control pin for the modulator can control On/Sleep state with bias as follows. <table border="1" style="margin: 10px auto;"> <thead> <tr> <th>V_{PS} (V)</th> <th>STATE</th> </tr> </thead> <tbody> <tr> <td>2.2 to 3.6</td> <td>ON (Active Mode)</td> </tr> <tr> <td>0 to 0.5</td> <td>OFF (Sleep Mode)</td> </tr> </tbody> </table>	V _{PS} (V)	STATE	2.2 to 3.6	ON (Active Mode)	0 to 0.5	OFF (Sleep Mode)	
V _{PS} (V)	STATE										
2.2 to 3.6	ON (Active Mode)										
0 to 0.5	OFF (Sleep Mode)										
8	GND (Modulator)	0	–	Ground pin for the modulator. Connect to the ground with minimum inductance. Track length should be kept as short as possible.							

PIN EXPLANATIONS

Pin No.	Symbol	Supply Vol. (V)	Pin Vol. (V) @3 V	Description	Equivalent Circuit
9	I	V _{cc} /2	-	Input for I signal. This input impedance is 180 kΩ. In case of that I/Q input signals are single ended, amplitude of the signal is 500 mVp-p max. Note 3	
10	Ib	V _{cc} /2	-	Input for I signal. This input impedance is 180 kΩ. In case of that I/Q input signals are single ended, V _{cc} /2 biased DC signal should be input. In case of that I/Q input signals are differential, amplitude of the signal is 250m Vp-p; max. Note 3	
11	Qb	V _{cc} /2	-	Input for Q signal. This input impedance is 180 kΩ. In case of that I/Q input signals are single ended, V _{cc} /2 biased DC signal should be input. In case of that I/Q input signals are differential, amplitude of the signal is 250 mVp-p max. Note 3	
12	Q	V _{cc} /2	-	Input for Q signal. This input impedance is 180 kΩ. In case of that I/Q input signals are single ended, amplitude of the signal is 500 mVp-p max. Note 3	
13	GND (Modulator)	0	-	Ground pin for the modulator. Connect to the ground with minimum inductance. Track length should be kept as short as possible.	—
14	V _{cc} 3	2.7 to 3.6	-	Supply voltage pin for the output buffer amplifier of modulator. An internal regulator helps keep the device stable against temperature or V _{cc} variation.	—
15	MODout	-	1.6	Output pin from the modulator. This is emitter follower output. So this output impedance is low.	
16	GND (Modulator)	0	-	Ground pin for the modulator. Connect to the ground with minimum inductance. Track length should be kept as short as possible.	—



PIN EXPLANATIONS

Pin No.	Symbol	Supply Vol. (V)	Pin Vol. (V) @3 V	Description	Equivalent Circuit						
17	V _{PS} 2 (Pre-Mix.)	V _{PS}	–	Power save control pin can control the On/Sleep state with bias as follows. <table border="1" style="margin: 10px auto;"> <thead> <tr> <th>V_{PS} (V)</th> <th>STATE</th> </tr> </thead> <tbody> <tr> <td>2.2 to 3.6</td> <td>ON (Active Mode)</td> </tr> <tr> <td>0 to 0.5</td> <td>OFF (Sleep Mode)</td> </tr> </tbody> </table>	V _{PS} (V)	STATE	2.2 to 3.6	ON (Active Mode)	0 to 0.5	OFF (Sleep Mode)	
V _{PS} (V)	STATE										
2.2 to 3.6	ON (Active Mode)										
0 to 0.5	OFF (Sleep Mode)										
18	IF-Loin	–	1.3	IF input pin for the pre-Mixer. This pin is biased internally. Capacitor should be connected in series, and grounded through 51 Ω.							
19	GND (Pre-Mix.)	0	–	Ground pin for modulator. Connect to the ground with minimum inductance. Track length should be kept as short as possible.	—						
20	RF-Loin	–	2.3	RF input pin for the pre-Mixer. This pin is biased internally. Capacitor should be connected in series, and grounded through 51 Ω.							

Note 3 Relations between amplitude and V_{cc}/2 bias of input signal are following.

Supply Voltage (V) V _{cc}	I/Q DC Voltage (V) V _{cc} /2 = I = I _b = Q = Q _b	I/Q input signal (mVp-p)	
		Single ended input I = Q	Differential input I = I _b = Q = Q _b
2.7 to 3.6	1.35 to 1.8	≤ 500	≤ 250

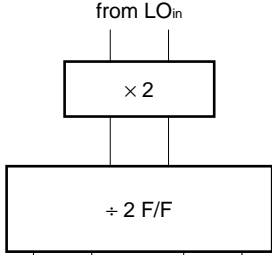
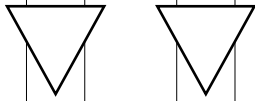
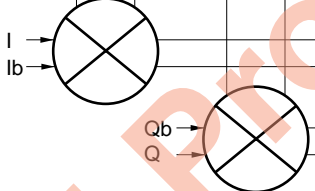
EXPLANATION OF INTERNAL FUNCTION

BLOCK	FUNCTION/OPERATION	BLOCK DIAGRAM
<p>90 ° PHASE SHIFTER</p>	<p>Input signal from L_o is send to digital circuit of T-type flip-flop through frequency doubler. Output signal from T-type F/F is changed to same frequency as L_o input and that have quadrature phase shift, 0 °, 90 °, 180 °, 270 °. These circuits have function of self phase correction to make correctly quadrature signals.</p>	
<p>BUFFER AMP.</p>	<p>Buffer amplifiers for each phase signals to send to each mixers.</p>	
<p>MIXER</p>	<p>Each signals from buffer amp. are quadrature modulated with two double-balanced mixers. High accurate phase and amplitude inputs are realized to good performance for image rejection.</p>	
<p>ADDER</p>	<p>Output signals from each mixers are added with adder and send to final amplifier.</p>	

Discontinued Product

STANDARD TYPICAL CHARACTERISTICS (Modulator+Pre-Mixer Total)

Test Circuit 2, $T_A = +25\text{ }^\circ\text{C}$, $V_{CC1} = V_{CC2} = V_{CC3} = 3.0\text{ V}$, $V_{PS1} = V_{PS2} = 3.0\text{ V}$,
 $I/Q\text{ (DC)} = I_b/Q_b\text{ (DC)} = V_{CC}/2$, $V_{I/Qin} = 420\text{ mVp-p}$ (Differential Input), $f_{I/Qin} = 2.625\text{ kHz}$,
 $f_{Fin} = 135\text{ MHz}$, $P_{IFin} = -12\text{ dBm}$, $f_{RFIn} = 813\text{ MHz}$, $P_{RFIn} = -11\text{ dBm}$, $f_{MODout} = 948\text{ MHz} + f_{I/Qin}$,
 Data Rate = 42 kbps, RNYQ : $\alpha = 0.5$,
 MOD Pattern : All Zero, Unless Otherwise Specified

I_{CC} (TOTAL) vs V_{CC}

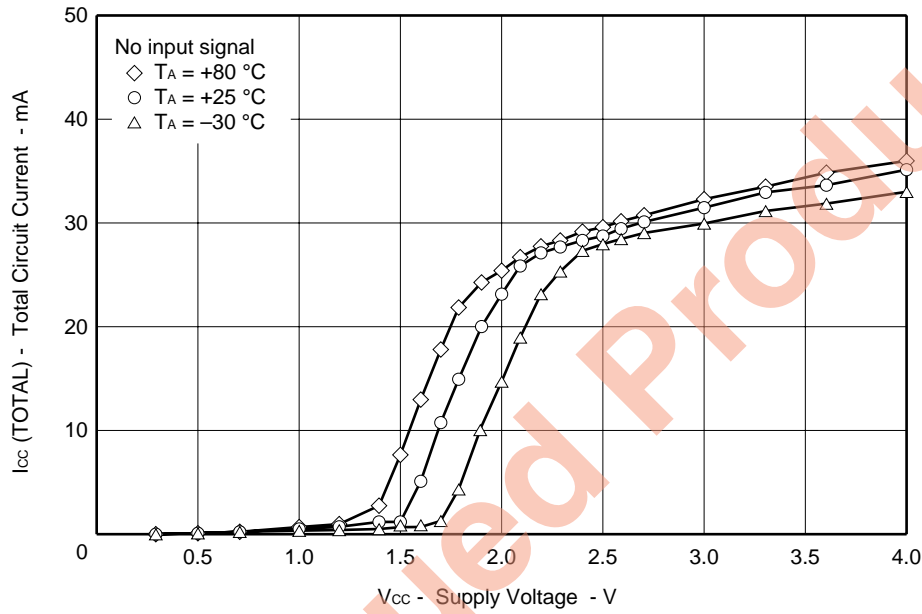

I_{CC} (TOTAL) vs V_{PS}

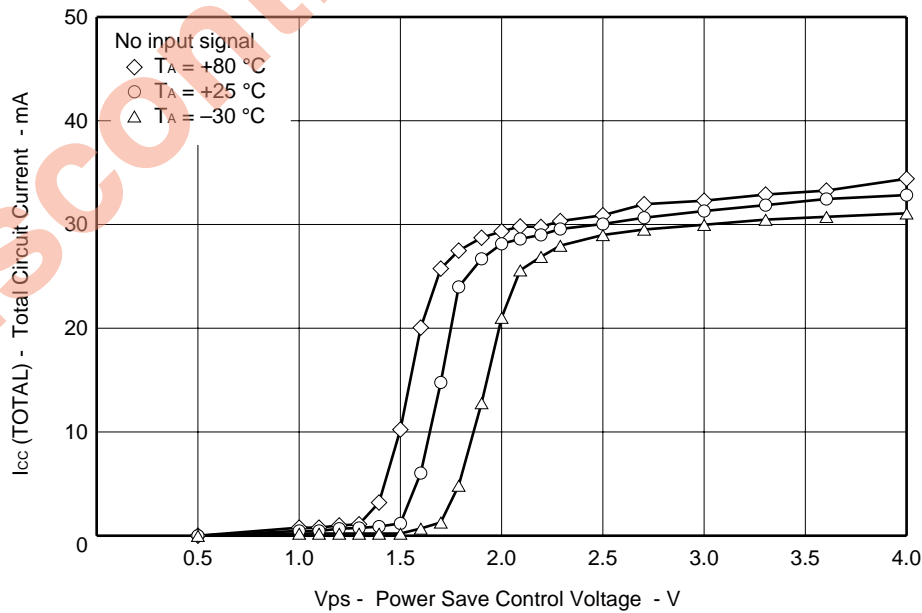

P_{MODout} VS $V_{I/Qin}$
(at $T_A = -30\text{ }^\circ\text{C}$)

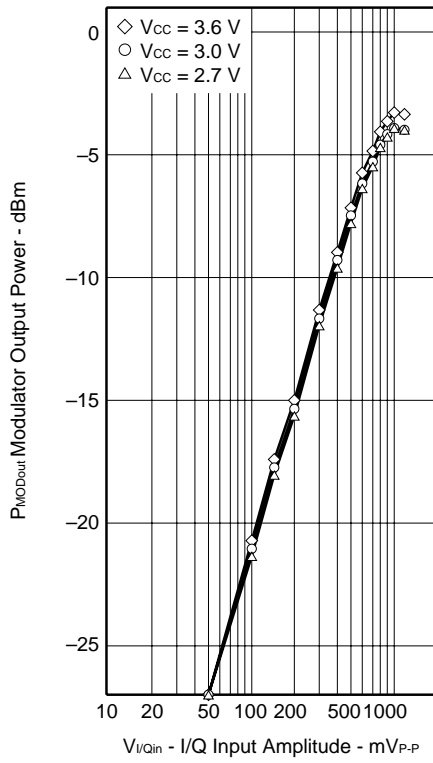

P_{MODout} VS $V_{I/Qin}$
(at $T_A = +25\text{ }^\circ\text{C}$)

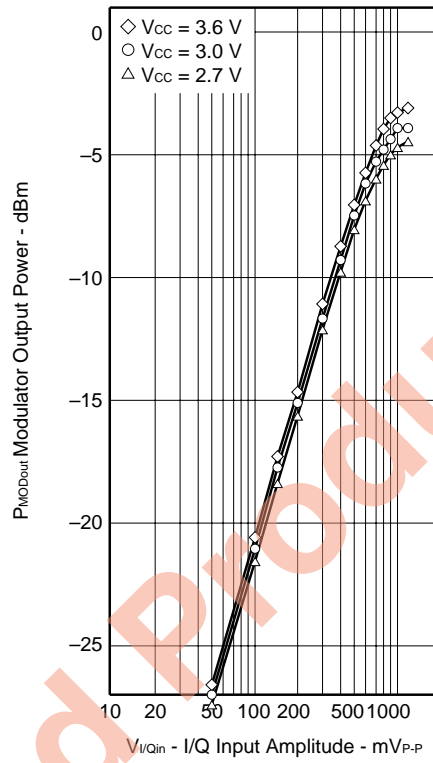

P_{MODout} VS $V_{I/Qin}$
(at $T_A = +80\text{ }^\circ\text{C}$)

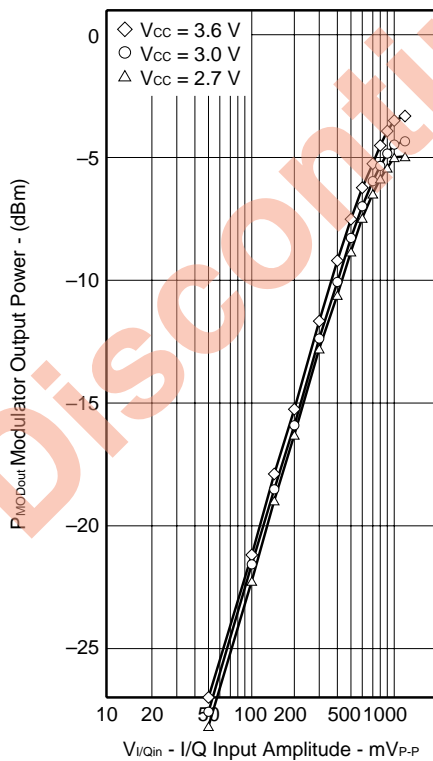

Discontinued Product

LoL, ImR, IM_{3(I/Q)} vs V_{I/Qin}
(at T_A = -30 °C)

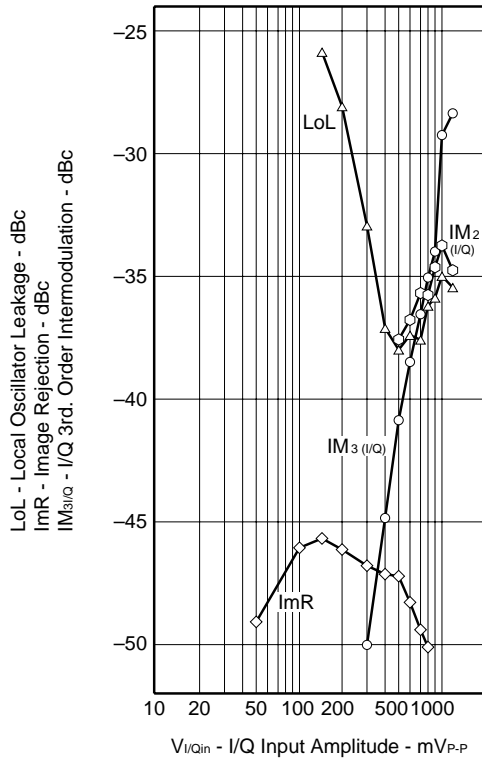

LoL, ImR, IM_{3(I/Q)} vs V_{I/Qin}
(at T_A = +25 °C)

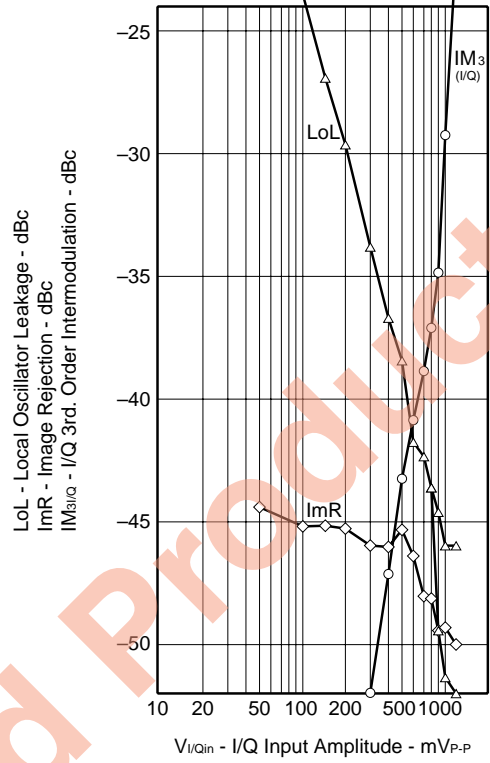

LoL, ImR, IM_{3(I/Q)} vs V_{I/Qin}
(at T_A = +80 °C)

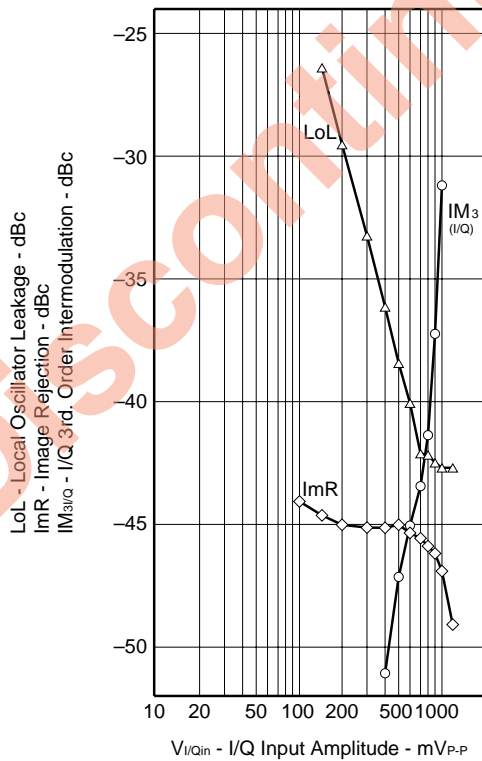

P_{MODout} , LoL, ImR, $IM_{3/I/Q}$ vs f_{LoIn}
(at $V_{CC} = 2.7\text{ V}$, $T_A = -30\text{ }^\circ\text{C}$)

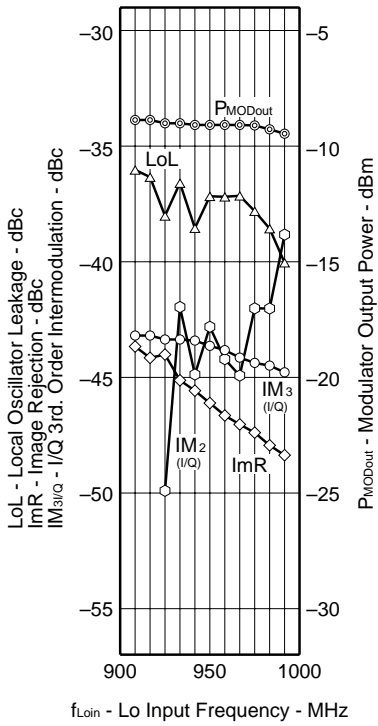

P_{MODout} , LoL, ImR, $IM_{3/I/Q}$ vs f_{LoIn}
(at $V_{CC} = 3.0\text{ V}$, $T_A = -30\text{ }^\circ\text{C}$)

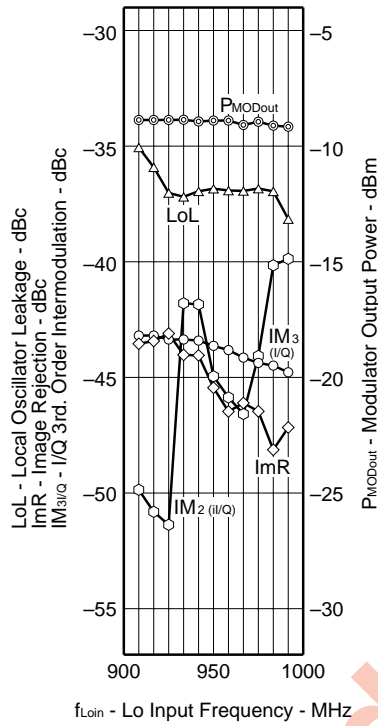

P_{MODout} , LoL, ImR, $IM_{3/I/Q}$ vs f_{LoIn}
(at $V_{CC} = 3.6\text{ V}$, $T_A = -30\text{ }^\circ\text{C}$)

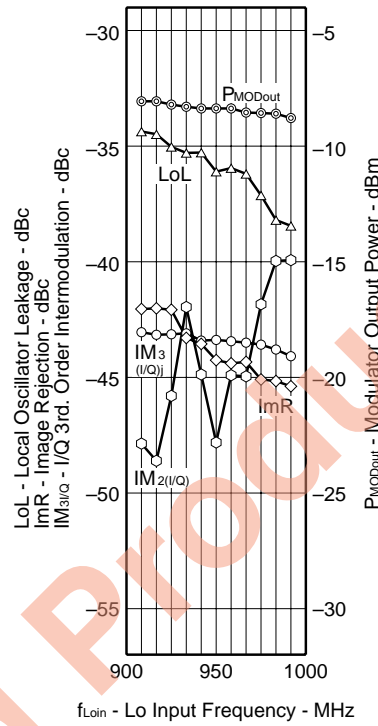

P_{MODout} , LoL, ImR, $IM_{3/I/Q}$ vs f_{LoIn}
(at $V_{CC} = 2.7\text{ V}$, $T_A = +25\text{ }^\circ\text{C}$)

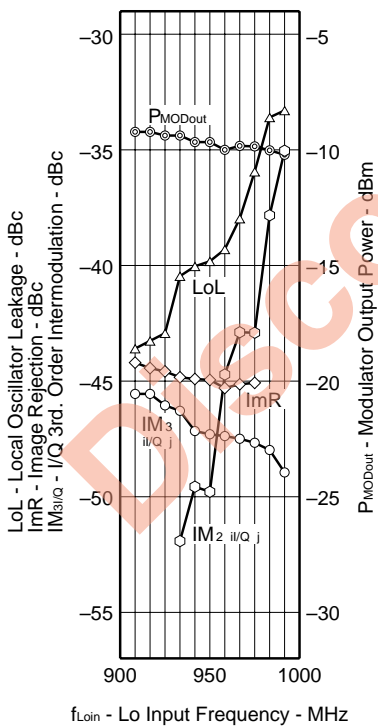

P_{MODout} , LoL, ImR, $IM_{3/I/Q}$ vs f_{LoIn}
(at $V_{CC} = 3.0\text{ V}$, $T_A = +25\text{ }^\circ\text{C}$)

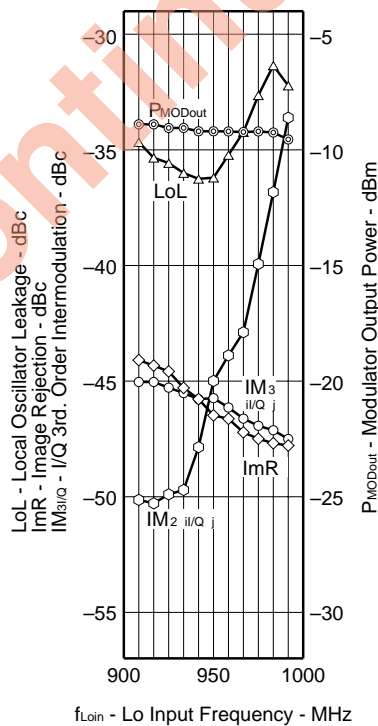

P_{MODout} , LoL, ImR, $IM_{3/I/Q}$ vs f_{LoIn}
(at $V_{CC} = 3.6\text{ V}$, $T_A = +25\text{ }^\circ\text{C}$)

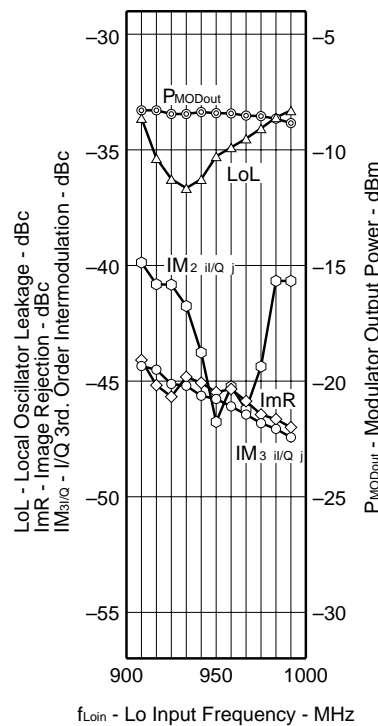

P_{MODout} , LoL, ImR, IM_{3/IQ} vs f_{LoIn}
(at $V_{CC} = 2.7\text{ V}$, $T_A = +80\text{ }^\circ\text{C}$)

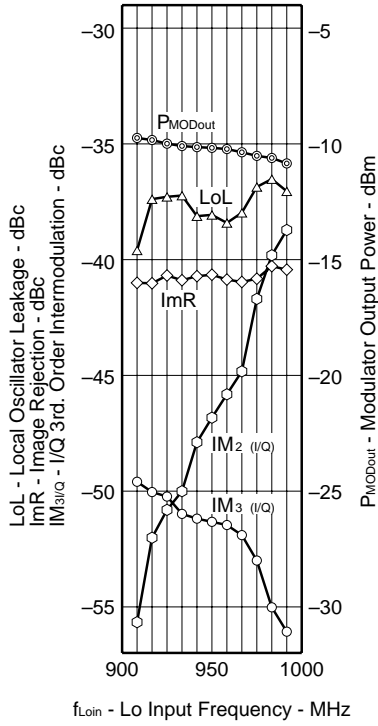

P_{MODout} , LoL, ImR, IM_{3/IQ} vs f_{LoIn}
(at $V_{CC} = 3.0\text{ V}$, $T_A = +80\text{ }^\circ\text{C}$)

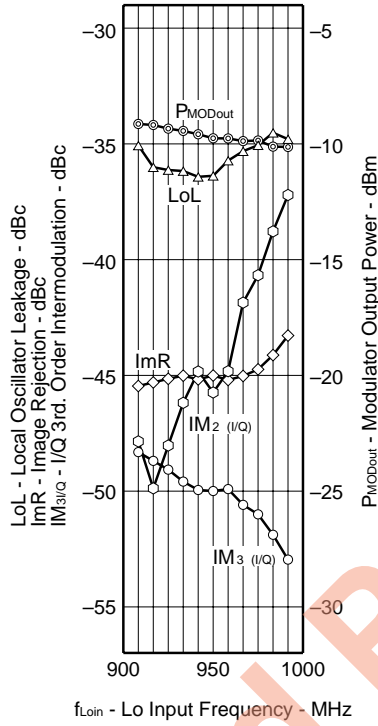

P_{MODout} , LoL, ImR, IM_{3/IQ} vs f_{LoIn}
(at $V_{CC} = 3.6\text{ V}$, $T_A = +80\text{ }^\circ\text{C}$)

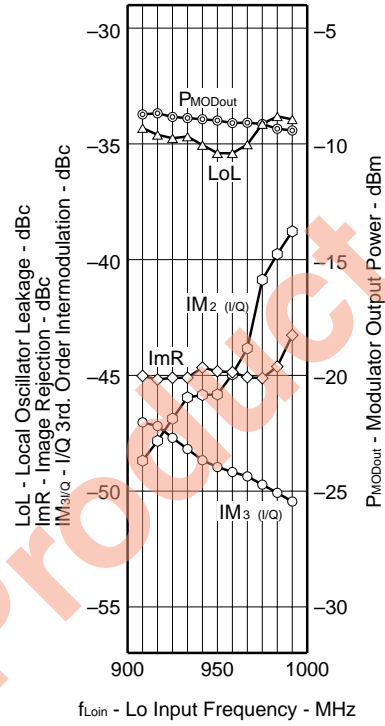

P_{MODout} , LoL, ImR, IM_{3/IQ} vs $P_{IF-LoIn}$
(at $V_{CC} = 2.7\text{ V}$, $T_A = -30\text{ }^\circ\text{C}$)

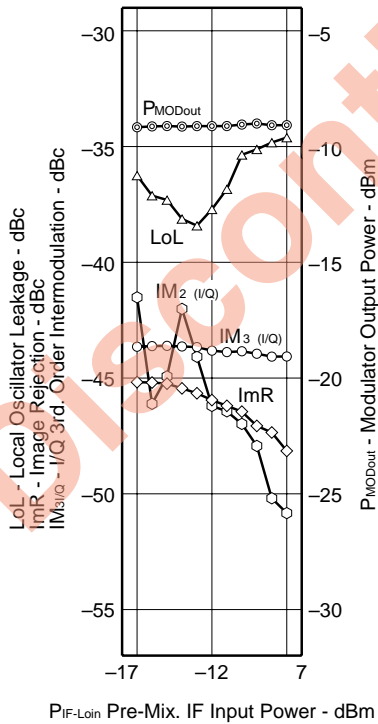

P_{MODout} , LoL, ImR, IM_{3/IQ} vs $P_{IF-LoIn}$
(at $V_{CC} = 3.0\text{ V}$, $T_A = -30\text{ }^\circ\text{C}$)

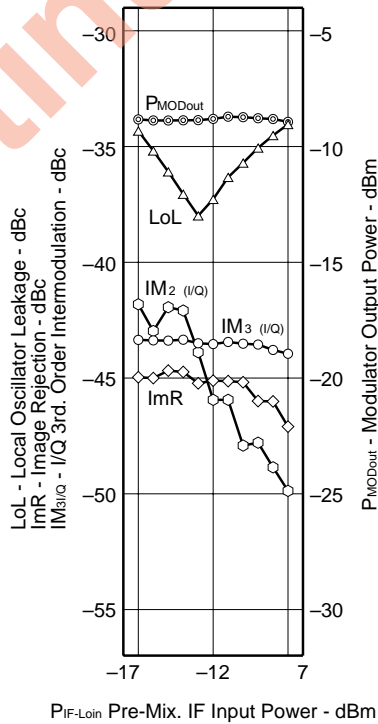

P_{MODout} , LoL, ImR, IM_{3/IQ} vs $P_{IF-LoIn}$
(at $V_{CC} = 3.6\text{ V}$, $T_A = -30\text{ }^\circ\text{C}$)

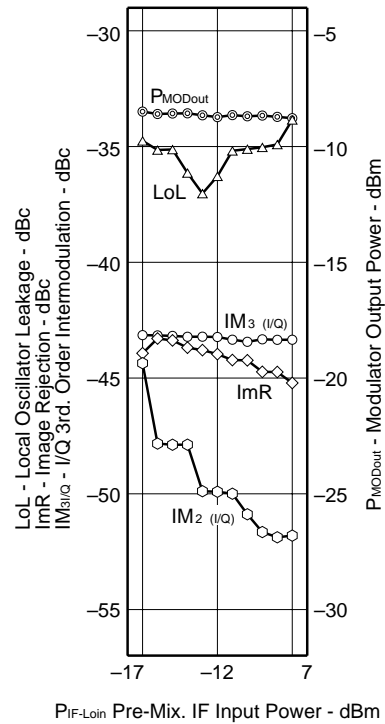

P_{MODout} , LoL, ImR, $IM_{3/IQ}$ vs $P_{IF-Loin}$
(at $V_{CC} = 2.7\text{ V}$, $T_A = +25\text{ }^\circ\text{C}$)

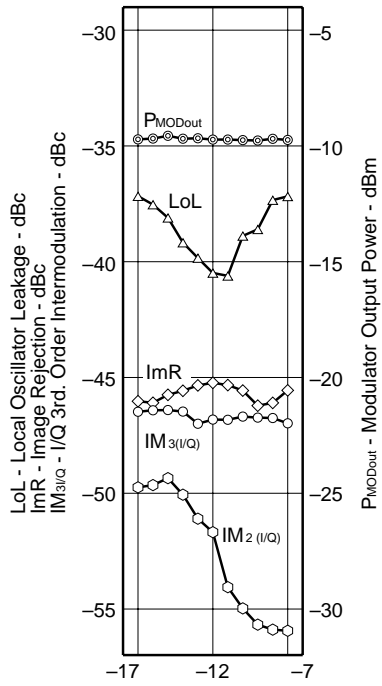

$P_{IF-Loin}$ - Pre-Mix. IF Input Power - dBm

P_{MODout} , LoL, ImR, $IM_{3/IQ}$ vs $P_{IF-Loin}$
(at $V_{CC} = 3.0\text{ V}$, $T_A = +25\text{ }^\circ\text{C}$)

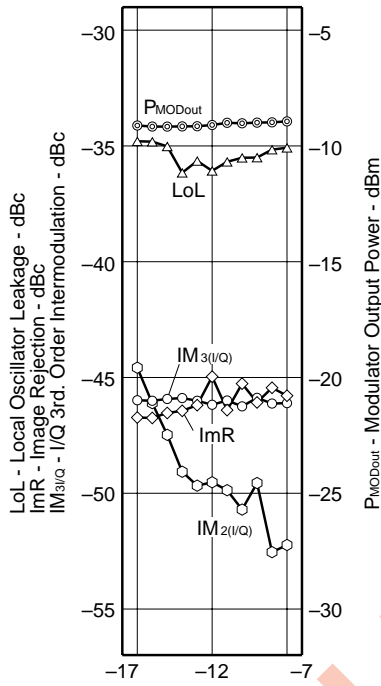

$P_{IF-Loin}$ - Pre-Mix. IF Input Power - dBm

P_{MODout} , LoL, ImR, $IM_{3/IQ}$ vs $P_{IF-Loin}$
(at $V_{CC} = 3.6\text{ V}$, $T_A = +25\text{ }^\circ\text{C}$)

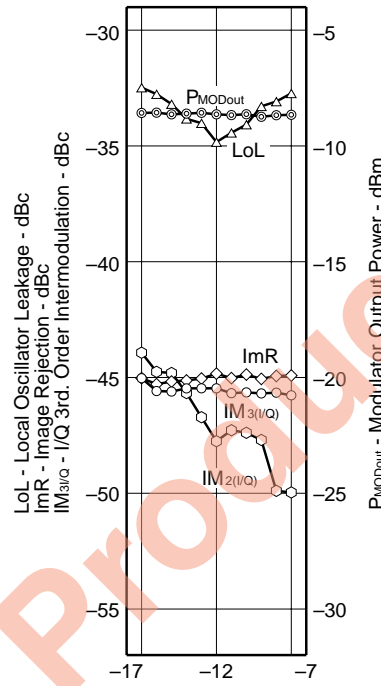

$P_{IF-Loin}$ - Pre-Mix. IF Input Power - dBm

P_{MODout} , LoL, ImR, $IM_{3/IQ}$ vs $P_{IF-Loin}$
(at $V_{CC} = 2.7\text{ V}$, $T_A = +80\text{ }^\circ\text{C}$)

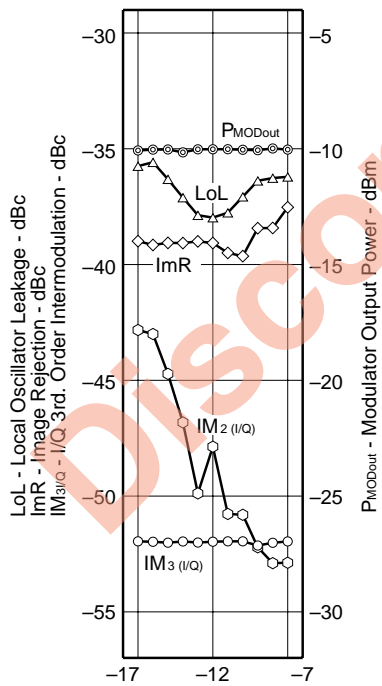

$P_{IF-Loin}$ - Pre-Mix. IF Input Power - dBm

P_{MODout} , LoL, ImR, $IM_{3/IQ}$ vs $P_{IF-Loin}$
(at $V_{CC} = 3.0\text{ V}$, $T_A = +80\text{ }^\circ\text{C}$)

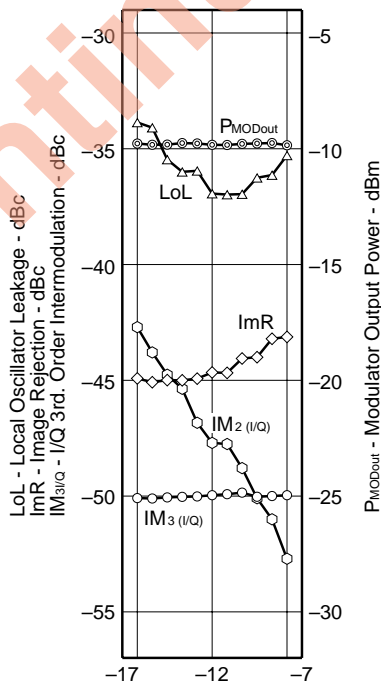

$P_{IF-Loin}$ - Pre-Mix. IF Input Power - dBm

P_{MODout} , LoL, ImR, $IM_{3/IQ}$ vs $P_{IF-Loin}$
(at $V_{CC} = 3.6\text{ V}$, $T_A = +80\text{ }^\circ\text{C}$)

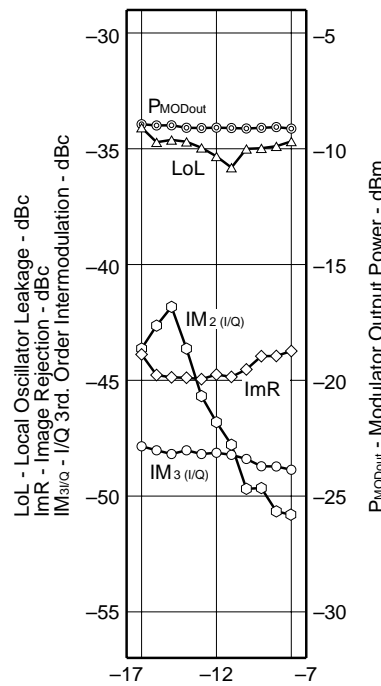

$P_{IF-Loin}$ - Pre-Mix. IF Input Power - dBm

P_{MODout} , LoL, ImR, $IM_{3/IQ}$ VS $P_{RF-LoIn}$
(at $V_{CC} = 2.7V$, $T_A = -30^\circ C$)

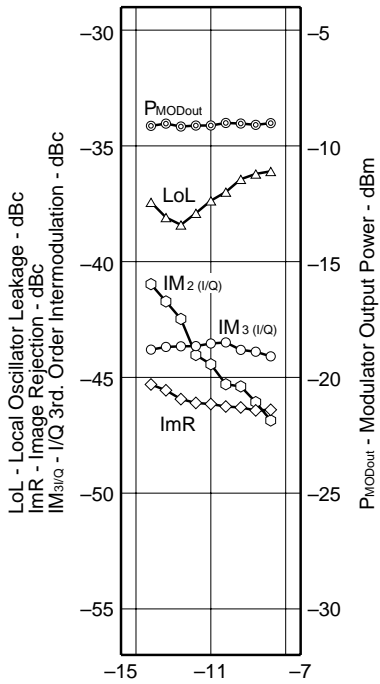

$P_{RF-LoIn}$ - Pre-Mix. RF Input Power - dBm

P_{MODout} , LoL, ImR, $IM_{3/IQ}$ VS $P_{RF-LoIn}$
(at $V_{CC} = 3.0V$, $T_A = -30^\circ C$)

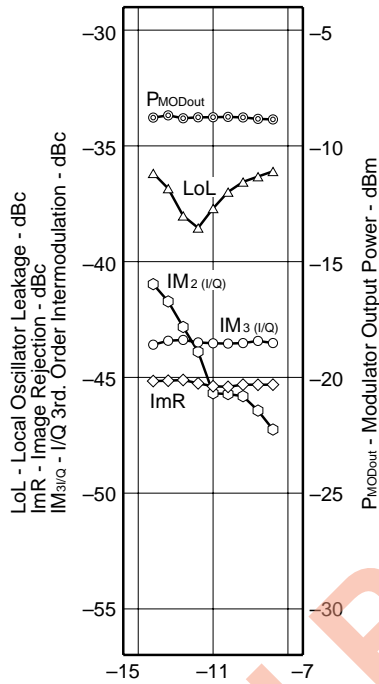

$P_{RF-LoIn}$ - Pre-Mix. RF Input Power - dBm

P_{MODout} , LoL, ImR, $IM_{3/IQ}$ VS $P_{RF-LoIn}$
(at $V_{CC} = 3.6V$, $T_A = -30^\circ C$)

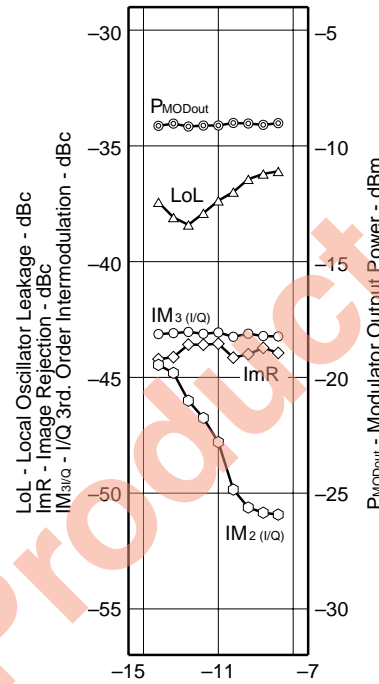

$P_{RF-LoIn}$ - Pre-Mix. RF Input Power - dBm

P_{MODout} , LoL, ImR, $IM_{3/IQ}$ VS $P_{RF-LoIn}$
(at $V_{CC} = 2.7V$, $T_A = +25^\circ C$)

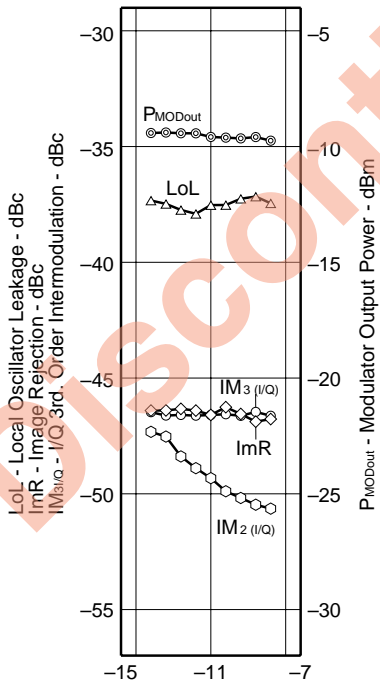

$P_{RF-LoIn}$ - Pre-Mix. RF Input Power - dBm

P_{MODout} , LoL, ImR, $IM_{3/IQ}$ VS $P_{RF-LoIn}$
(at $V_{CC} = 3.0V$, $T_A = +25^\circ C$)

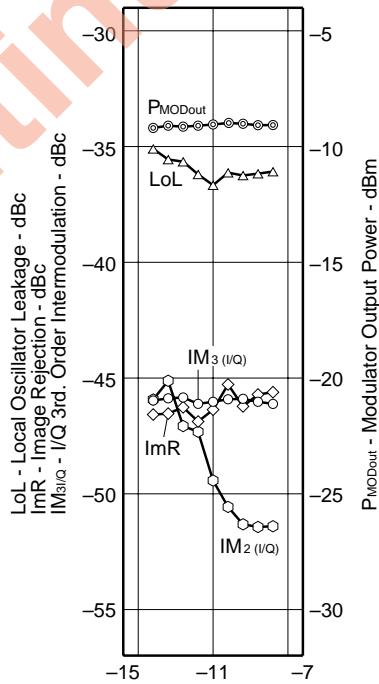

$P_{RF-LoIn}$ - Pre-Mix. RF Input Power - dBm

P_{MODout} , LoL, ImR, $IM_{3/IQ}$ VS $P_{RF-LoIn}$
(at $V_{CC} = 3.6V$, $T_A = +25^\circ C$)

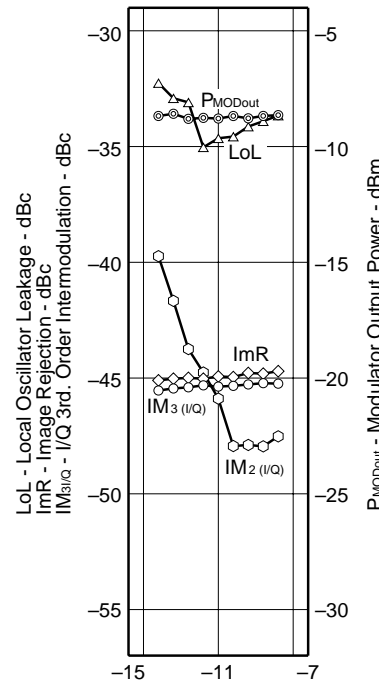

$P_{RF-LoIn}$ - Pre-Mix. RF Input Power - dBm

P_{MODout} , LoL, ImR, IM_{3/IQ} vs $P_{RF-LoIn}$
(at $V_{CC} = 2.7\text{ V}$, $T_A = +80\text{ °C}$)

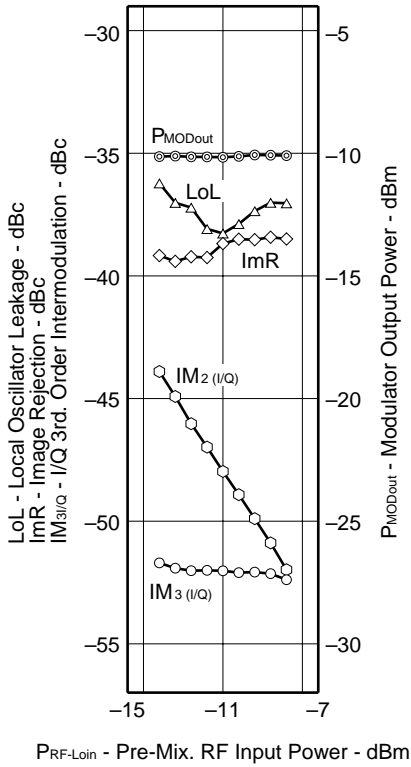

P_{MODout} , LoL, ImR, IM_{3/IQ} vs $P_{RF-LoIn}$
(at $V_{CC} = 3.0\text{ V}$, $T_A = +80\text{ °C}$)

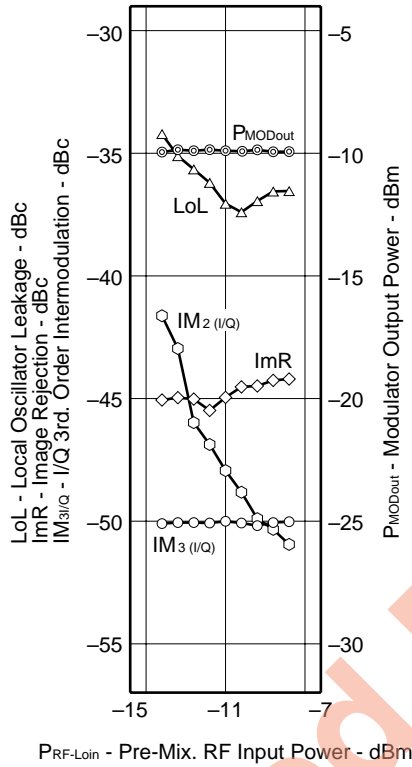

P_{MODout} , LoL, ImR, IM_{3/IQ} vs $P_{RF-LoIn}$
(at $V_{CC} = 3.6\text{ V}$, $T_A = +80\text{ °C}$)

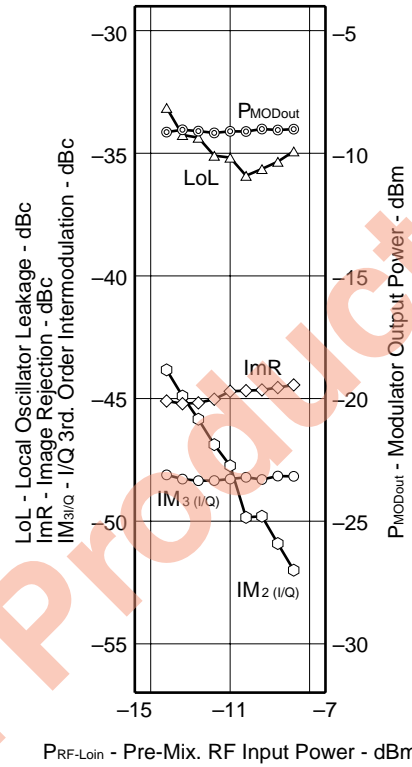

Discontinued Product

P_{MODout} , LoL, ImR, $IM_{3/IQ}$ vs I/Q(DC)
(at $V_{CC} = 2.7\text{ V}$, $T_A = -30\text{ }^\circ\text{C}$)

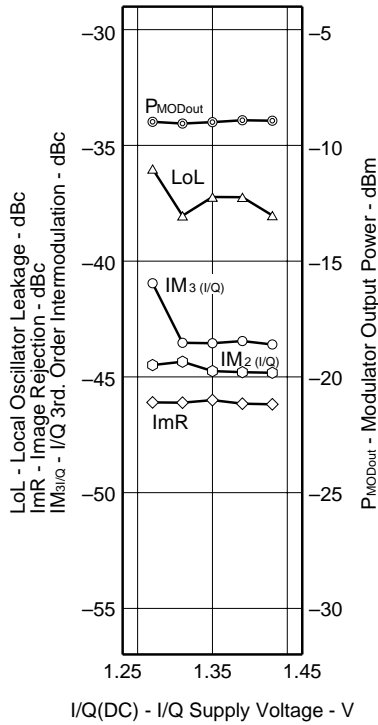

P_{MODout} , LoL, ImR, $IM_{3/IQ}$ vs I/Q(DC)
(at $V_{CC} = 3.0\text{ V}$, $T_A = -30\text{ }^\circ\text{C}$)

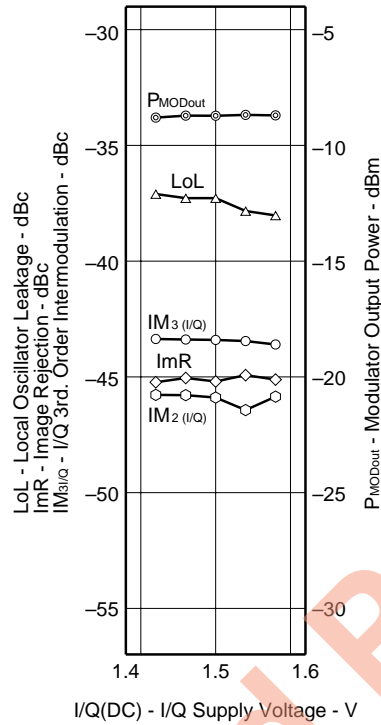

P_{MODout} , LoL, ImR, $IM_{3/IQ}$ vs I/Q(DC)
(at $V_{CC} = 3.6\text{ V}$, $T_A = -30\text{ }^\circ\text{C}$)

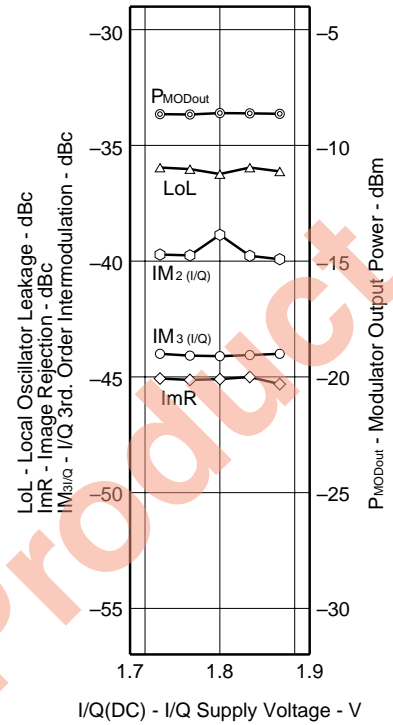

P_{MODout} , LoL, ImR, $IM_{3/IQ}$ vs I/Q(DC)
(at $V_{CC} = 2.7\text{ V}$, $T_A = +25\text{ }^\circ\text{C}$)

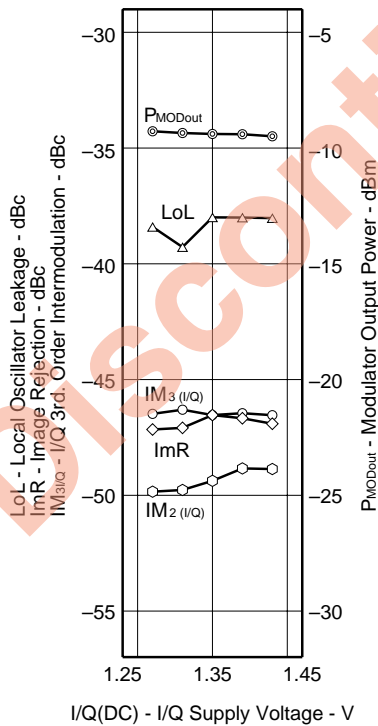

P_{MODout} , LoL, ImR, $IM_{3/IQ}$ vs I/Q(DC)
(at $V_{CC} = 3.0\text{ V}$, $T_A = +25\text{ }^\circ\text{C}$)

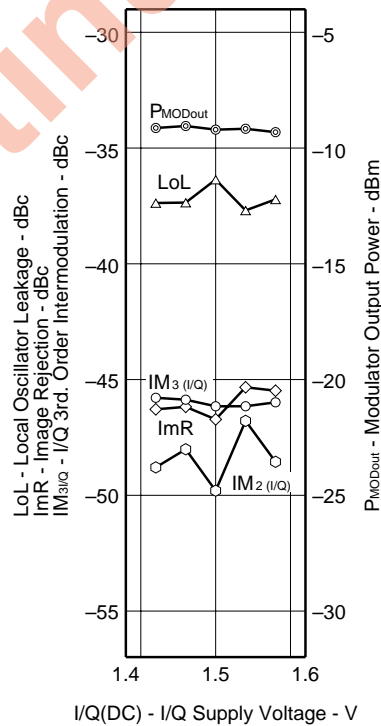

P_{MODout} , LoL, ImR, $IM_{3/IQ}$ vs I/Q(DC)
(at $V_{CC} = 3.6\text{ V}$, $T_A = +25\text{ }^\circ\text{C}$)

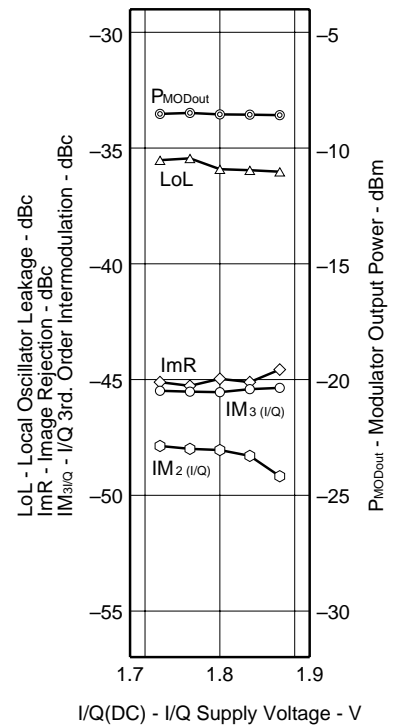

P_{MODout} , LoL, ImR, IM_{3/IQ} vs I/Q(DC)
(at $V_{CC} = 2.7\text{ V}$, $T_A = +80\text{ }^\circ\text{C}$)

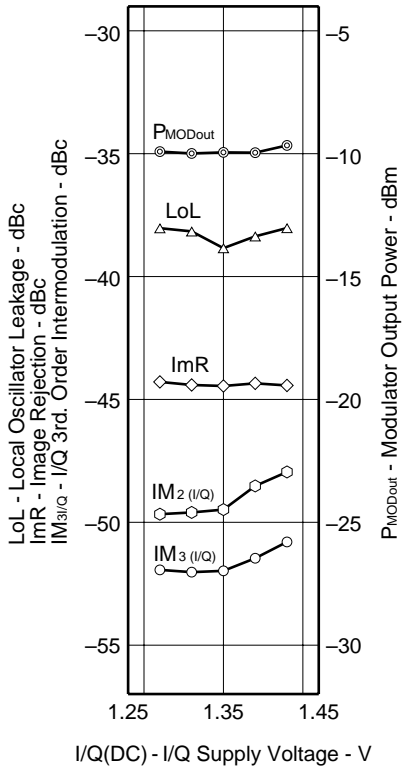

P_{MODout} , LoL, ImR, IM_{3/IQ} vs I/Q(DC)
(at $V_{CC} = 3.0\text{ V}$, $T_A = +80\text{ }^\circ\text{C}$)

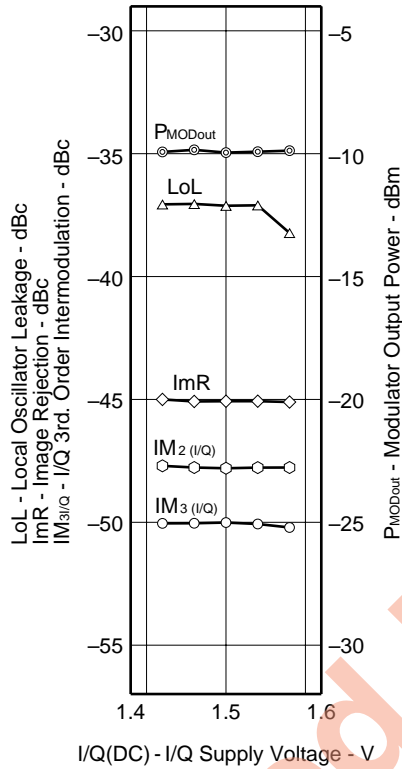

P_{MODout} , LoL, ImR, IM_{3/IQ} vs I/Q(DC)
(at $V_{CC} = 3.6\text{ V}$, $T_A = +80\text{ }^\circ\text{C}$)

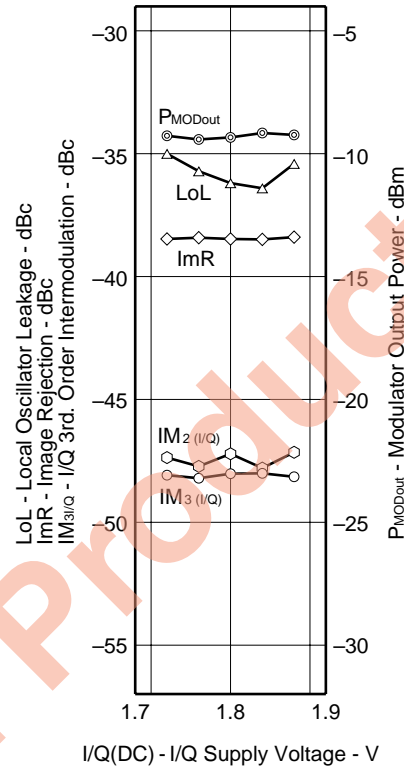

Discontinued Product

$P(f_{IF} \times 7)$ vs $P_{IF-LoIn}$
(at $V_{CC} = 2.7\text{ V}$, $T_A = -30\text{ }^\circ\text{C}$)

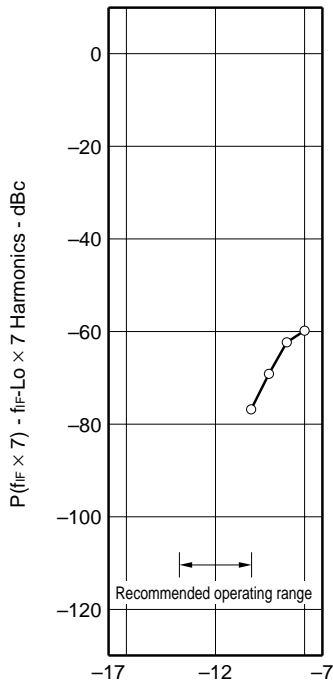

$P_{IF-LoIn}$ - Pre-Mix. IF Input Power - dBm

$P(f_{IF} \times 7)$ vs $P_{IF-LoIn}$
(at $V_{CC} = 3.0\text{ V}$, $T_A = -30\text{ }^\circ\text{C}$)

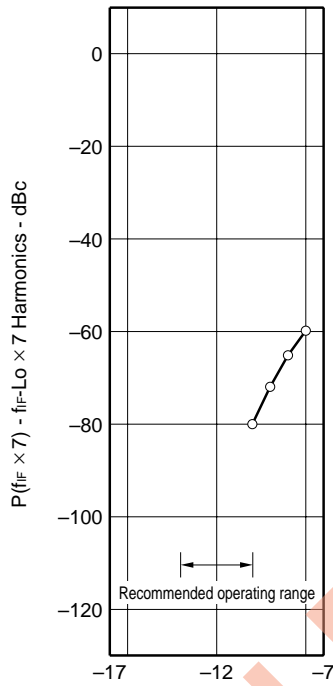

$P_{IF-LoIn}$ - Pre-Mix. IF Input Power - dBm

$P(f_{IF} \times 7)$ vs $P_{IF-LoIn}$
(at $V_{CC} = 3.6\text{ V}$, $T_A = -30\text{ }^\circ\text{C}$)

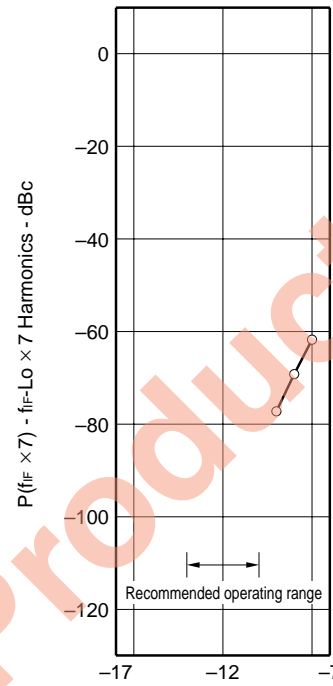

$P_{IF-LoIn}$ - Pre-Mix. IF Input Power - dBm

$P(f_{IF} \times 7)$ vs $P_{IF-LoIn}$
(at $V_{CC} = 2.7\text{ V}$, $T_A = +25\text{ }^\circ\text{C}$)

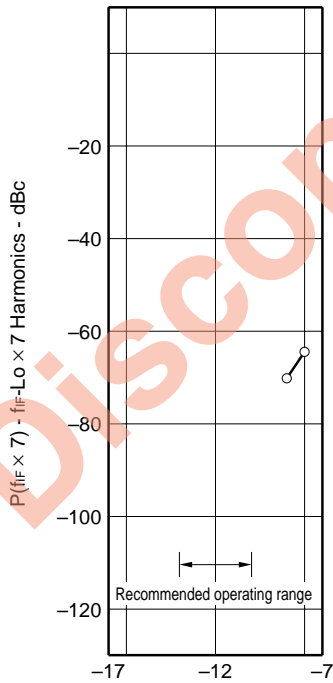

$P_{IF-LoIn}$ - Pre-Mix. IF Input Power - dBm

$P(f_{IF} \times 7)$ vs $P_{IF-LoIn}$
(at $V_{CC} = 3.0\text{ V}$, $T_A = +25\text{ }^\circ\text{C}$)

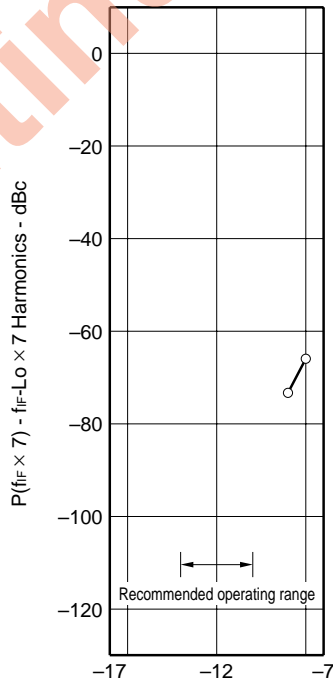

$P_{IF-LoIn}$ - Pre-Mix. IF Input Power - dBm

$P(f_{IF} \times 7)$ vs $P_{IF-LoIn}$
(at $V_{CC} = 3.6\text{ V}$, $T_A = +25\text{ }^\circ\text{C}$)

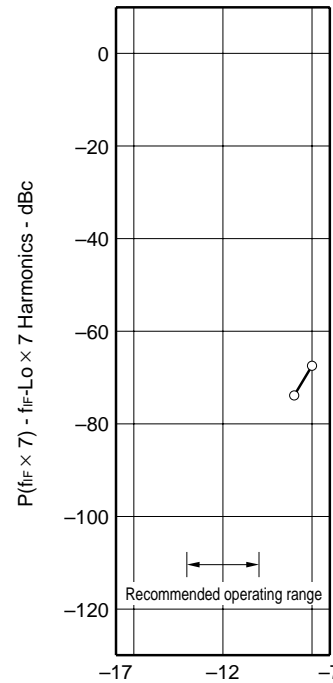

$P_{IF-LoIn}$ - Pre-Mix. IF Input Power - dBm

$P(f_{IF} \times 7)$ vs $P_{IF-LoIn}$
(at $V_{CC} = 2.7\text{ V}$, $T_A = +80\text{ }^\circ\text{C}$)

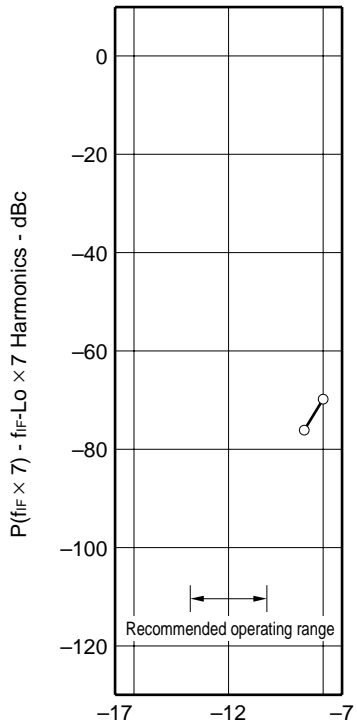

$P_{IF-LoIn}$ - Pre-Mix. IF Input Power - dBm

$P(f_{IF} \times 7)$ vs $P_{IF-LoIn}$
(at $V_{CC} = 3.0\text{ V}$, $T_A = +80\text{ }^\circ\text{C}$)

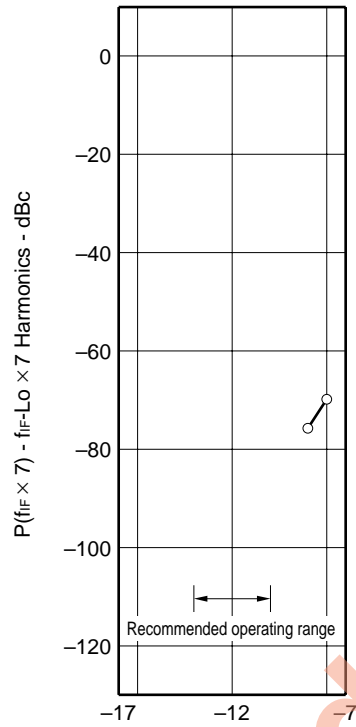

$P_{IF-LoIn}$ - Pre-Mix. IF Input Power - dBm

$P(f_{IF} \times 7)$ vs $P_{IF-LoIn}$
(at $V_{CC} = 3.6\text{ V}$, $T_A = +80\text{ }^\circ\text{C}$)

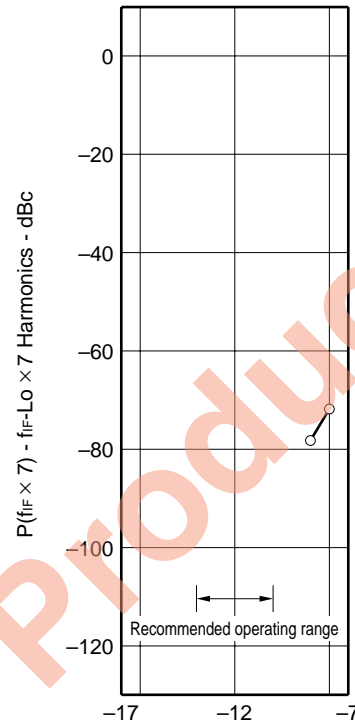

$P_{IF-LoIn}$ - Pre-Mix. IF Input Power - dBm

Discontinued Product

EVM, $\Delta\phi$, ΔA vs $V_{I/Qin}$
(at $V_{CC} = 2.7$ V)

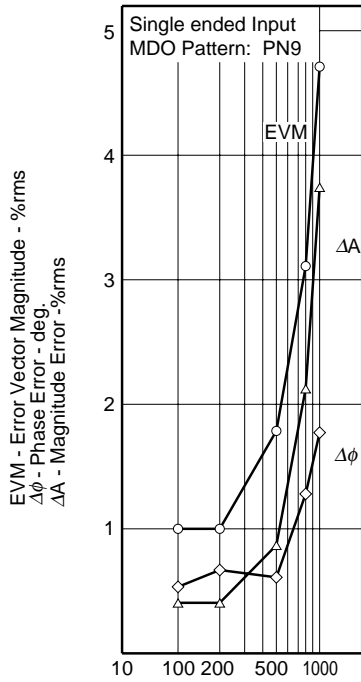

EVM, $\Delta\phi$, ΔA vs $V_{I/Qin}$
(at $V_{CC} = 3.0$ V)

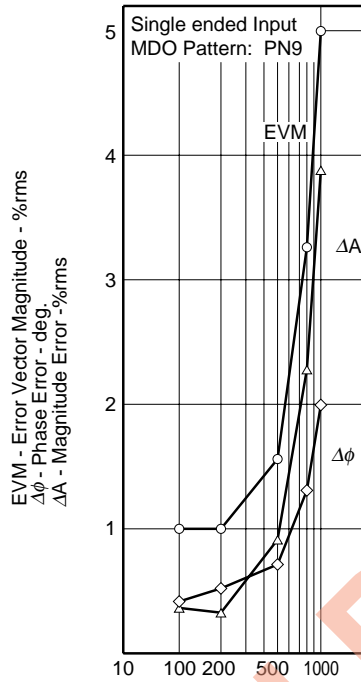

EVM, $\Delta\phi$, ΔA vs $V_{I/Qin}$
(at $V_{CC} = 3.6$ V)

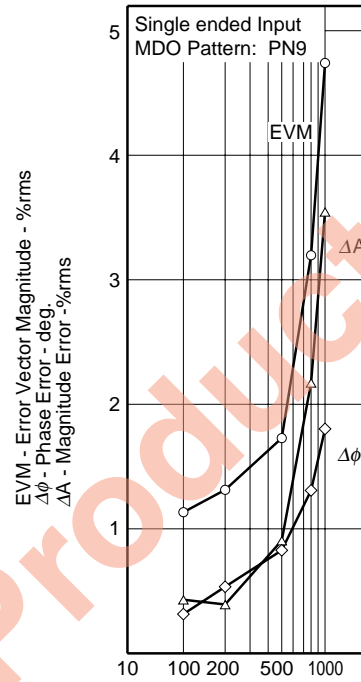

ACP vs $V_{I/Qin}$
(at $V_{CC} = 2.7$ V)

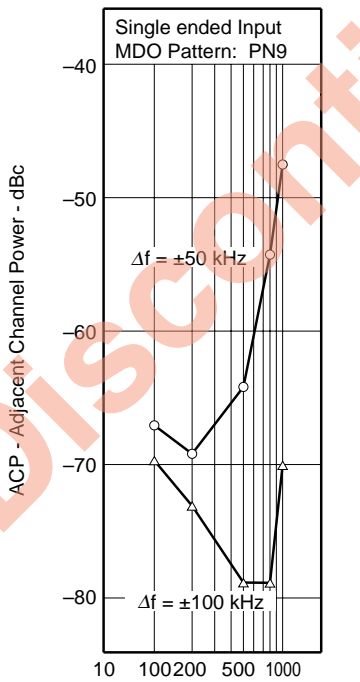

ACP vs $V_{I/Qin}$
(at $V_{CC} = 3.0$ V)

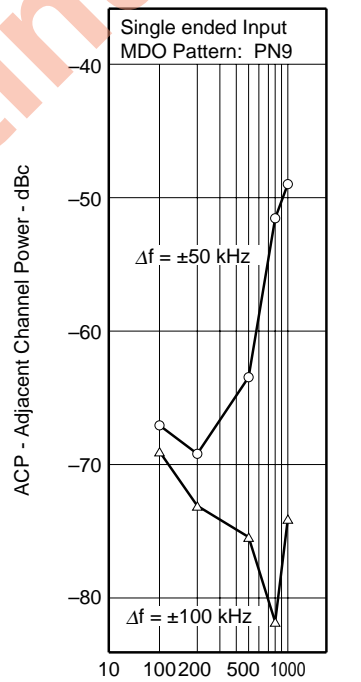

ACP vs $V_{I/Qin}$
(at $V_{CC} = 3.6$ V)

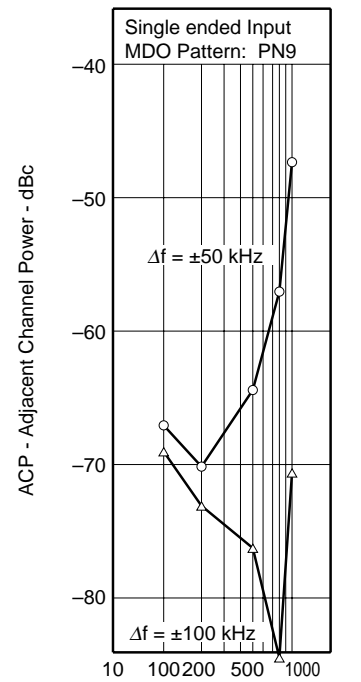

TYPICAL SINE WAVE MODULATION OUTPUT SPECTRUM
 <PDC> 42kbps, RNYQ $\alpha = 0.5$, MOD Pattern [000]

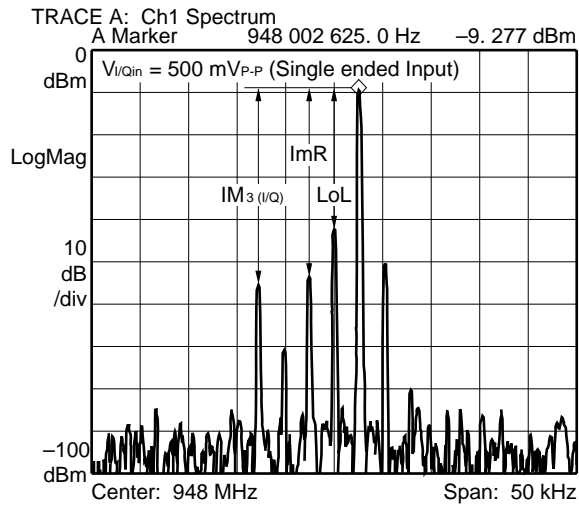

TYPICAL $\pi/4$ DQPSK MODULATION OUTPUT SPECTRUM
 <PDC> 42kbps, RNYQ $\alpha = 0.5$, MOD Pattern [PN9]

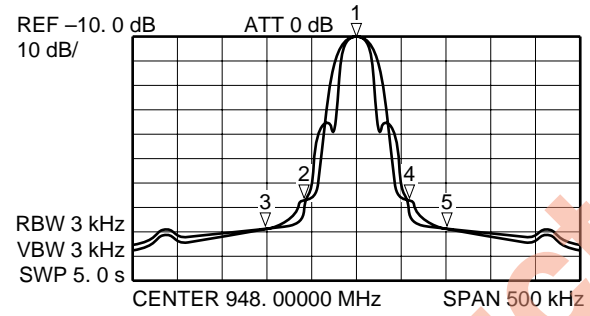

*** Multi Marker List ***

No. 1:	0 Hz	0.00 dB
No. 2:	-50.0 kHz	-64.50 dB
No. 3:	-100.0 kHz	-77.00 dB
No. 4:	50.0 kHz	-64.75 dB
No. 5:	100.0 kHz	-77.00 dB

Discontinued Product

MOD OUTPUT (15 pin) IMPEDANCE

$V_{CC} = V_{PS} = 2.7\text{ V}$

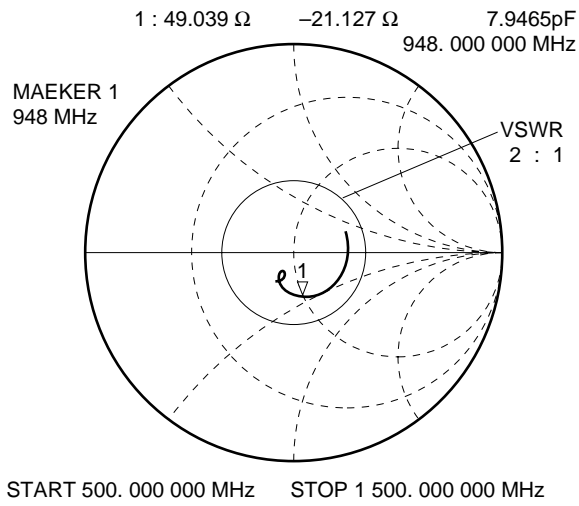

$V_{CC} = V_{PS} = 3.0\text{ V}$

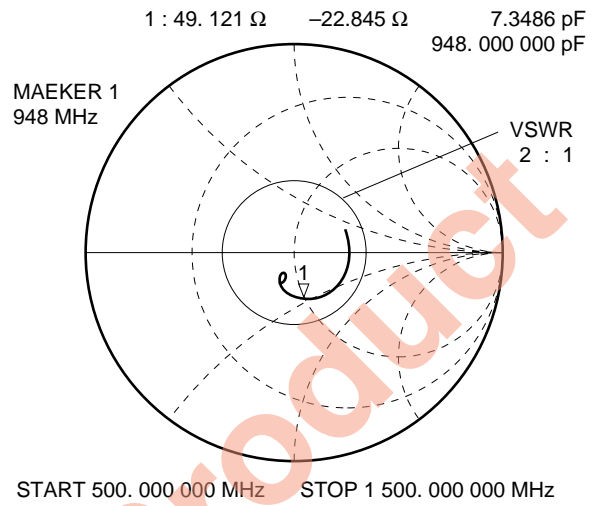

$V_{CC} = V_{PS} = 3.6\text{ V}$

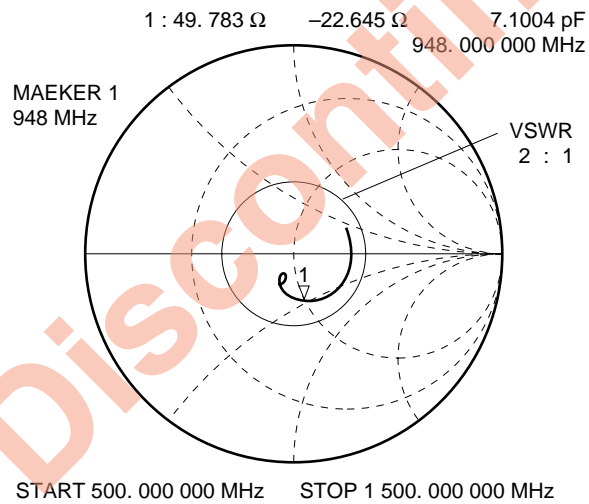

STANDARD TYPICAL CHARACTERISTICS <Pre-Mixer>

Test Circuit 3, $T_A = +25\text{ }^\circ\text{C}$, $V_{cc1} = 3.0\text{ V}$, $V_{ps2} = 3.0\text{ V}$, $f_{iFin} = 135\text{ MHz}$, $P_{iFin} = -12\text{ dBm}$, $f_{rFin} = 813\text{ MHz}$,
 $P_{rFin} = -11\text{ dBm}$, $f_{MIXout} = 948\text{ MHz}$

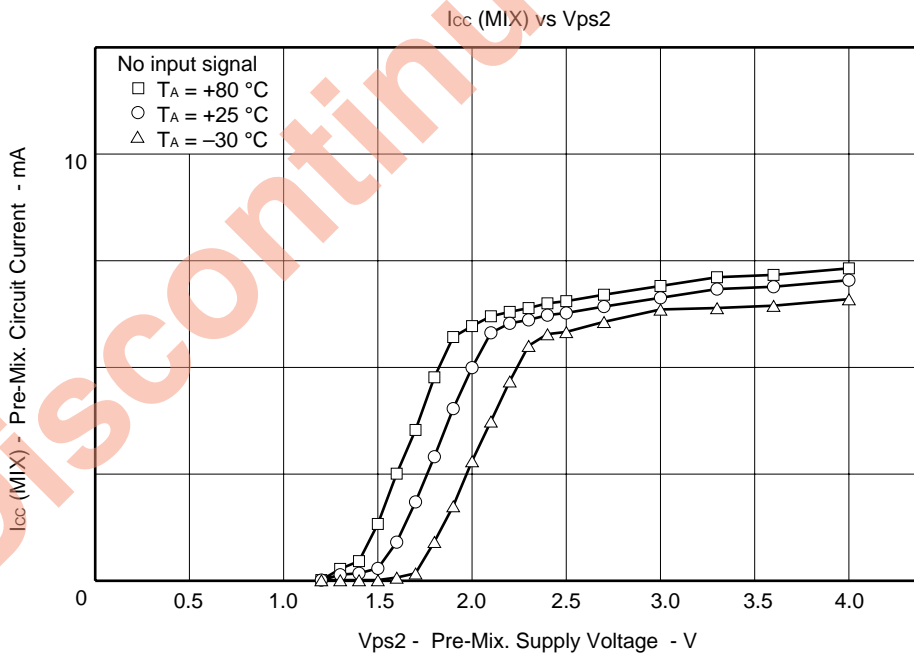
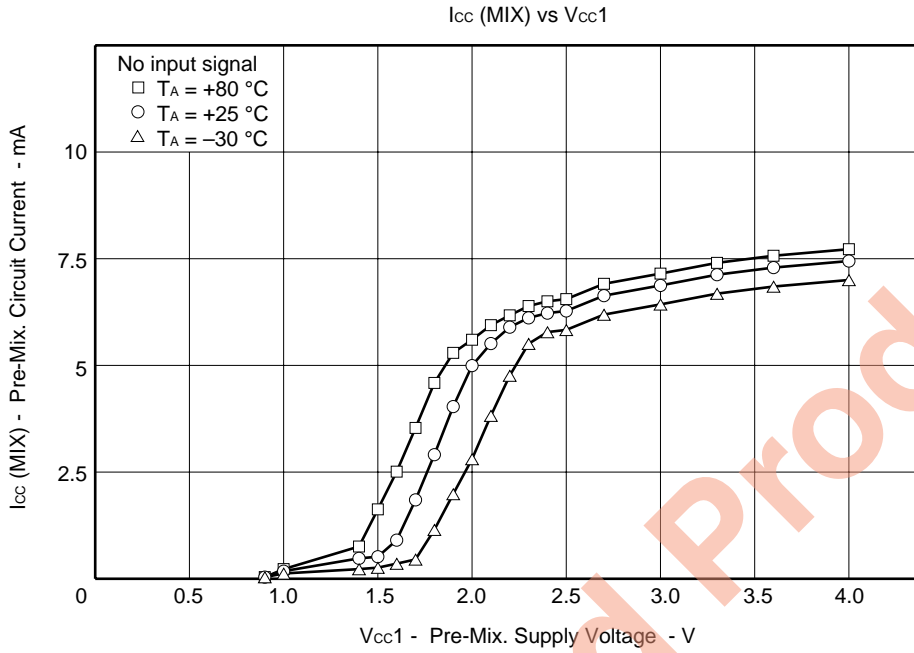

P_{out} (MIX), RFL, ImL, P(f_{IF} × 7)
vs P_{IF-LoIn}
(at V_{CC} = 2.7 V, T_A = -30 °C)

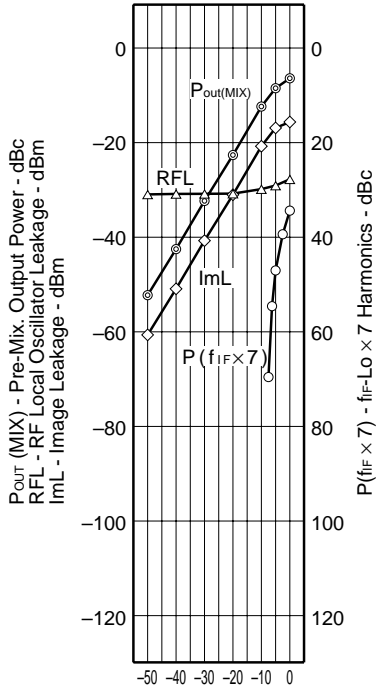

P_{IF-LoIn} - Pre-Mix. IF Input Power - dBm

P_{out} (MIX), RFL, ImL, P(f_{IF} × 7)
vs P_{IF-LoIn}
(at V_{CC} = 3.0 V, T_A = -30 °C)

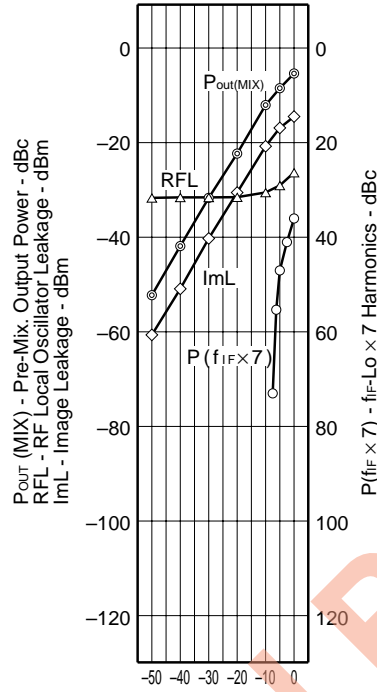

P_{IF-LoIn} - Pre-Mix. IF Input Power - dBm

P_{out} (MIX), RFL, ImL, P(f_{IF} × 7)
vs P_{IF-LoIn}
(at V_{CC} = 3.6 V, T_A = -30 °C)

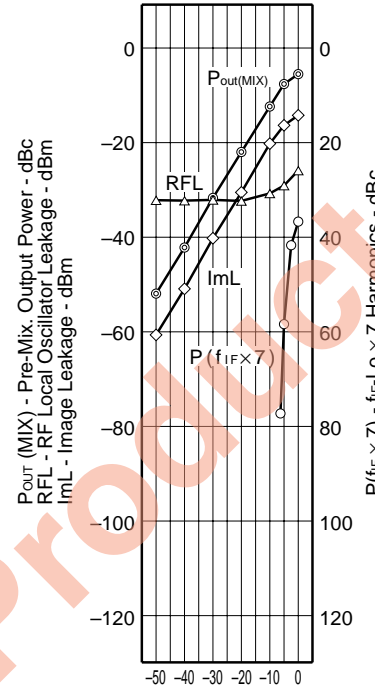

P_{IF-LoIn} - Pre-Mix. IF Input Power - dBm

P_{out} (MIX), RFL, ImL, P(f_{IF} × 7)
vs P_{IF-LoIn}
(at V_{CC} = 2.7 V, T_A = +25 °C)

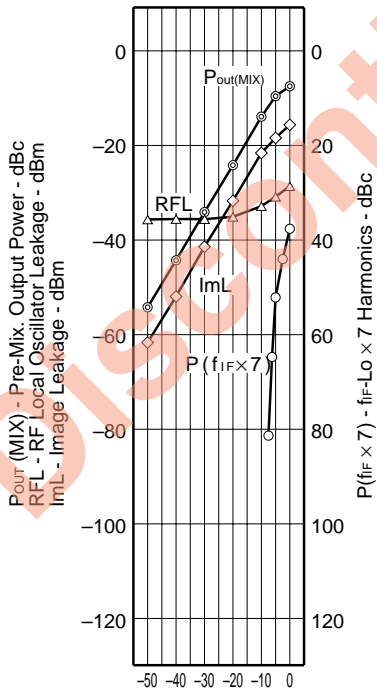

P_{IF-LoIn} - Pre-Mix. IF Input Power - dBm

P_{out} (MIX), RFL, ImL, P(f_{IF} × 7)
vs P_{IF-LoIn}
(at V_{CC} = 3.0 V, T_A = +25 °C)

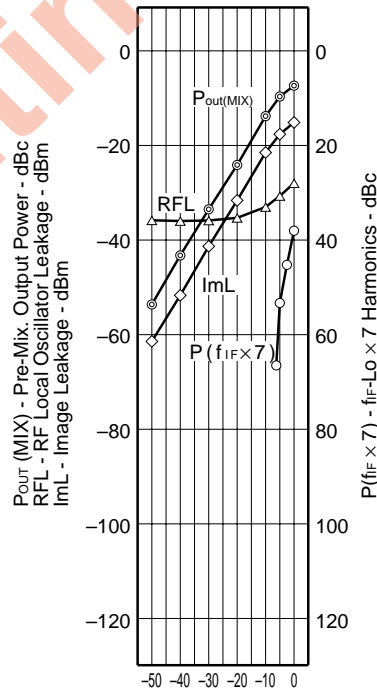

P_{IF-LoIn} - Pre-Mix. IF Input Power - dBm

P_{out} (MIX), RFL, ImL, P(f_{IF} × 7)
vs P_{IF-LoIn}
(at V_{CC} = 3.6 V, T_A = +25 °C)

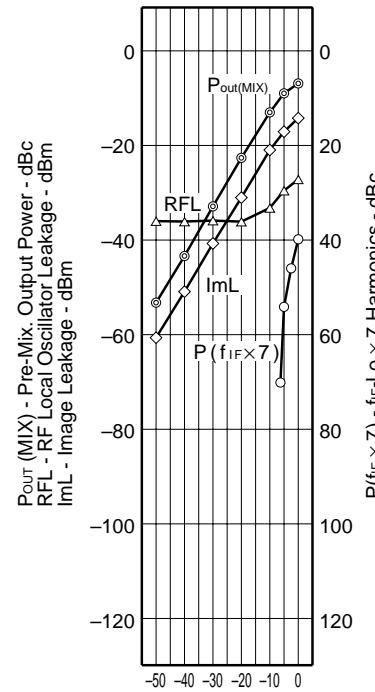

P_{IF-LoIn} - Pre-Mix. IF Input Power - dBm

P_{out} (MIX), RFL, ImL, P(f_{IF} × 7)
vs P_{IF-LoIn}
(at V_{CC} = 2.7 V, T_A = +80 °C)

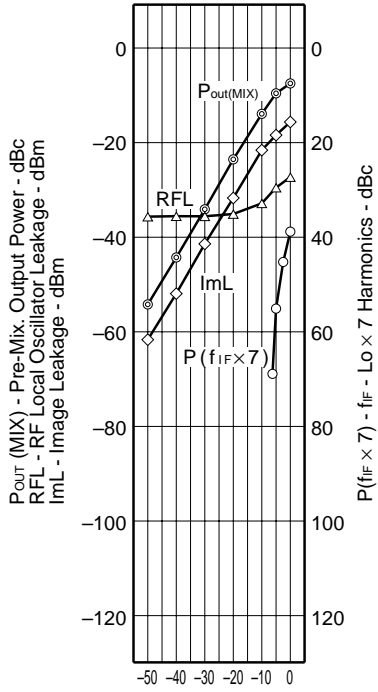

P_{IF-LoIn} - Pre-Mix. IF Input Power - dBm

P_{out} (MIX), RFL, ImL, P(f_{IF} × 7)
vs P_{IF-LoIn}
(at V_{CC} = 3.0 V, T_A = +80 °C)

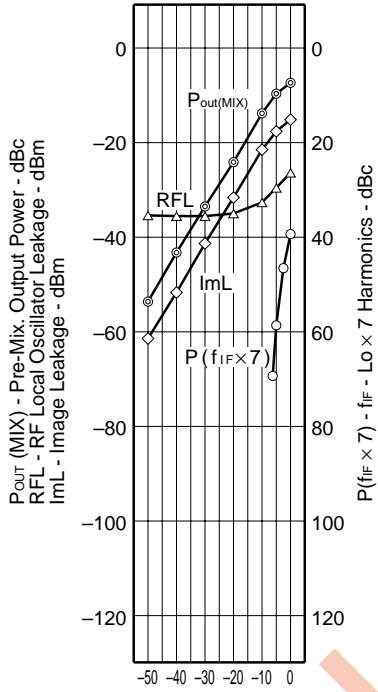

P_{IF-LoIn} - Pre-Mix. IF Input Power - dBm

P_{out} (MIX), RFL, ImL, P(f_{IF} × 7)
vs P_{IF-LoIn}
(at V_{CC} = 3.6 V, T_A = +80 °C)

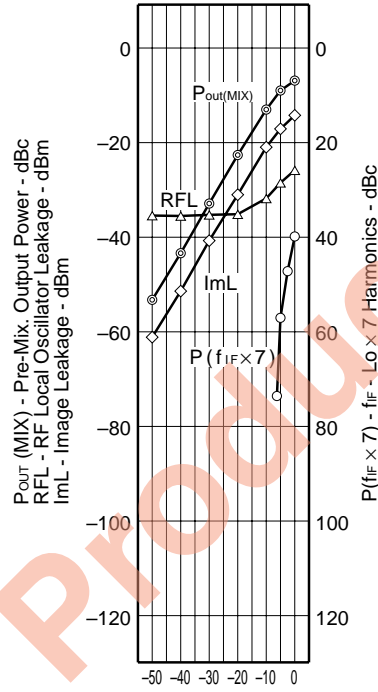

P_{IF-LoIn} - Pre-Mix. IF Input Power - dBm

P_{out} (MIX), RFL, ImL vs P_{RF-LoIn}
(at V_{CC} = 2.7 V, T_A = -30 °C)

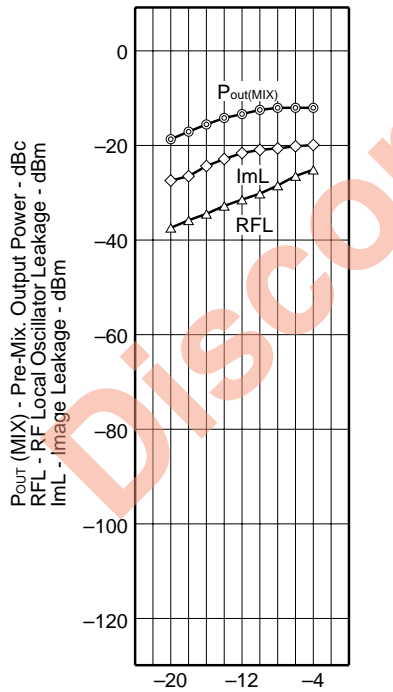

P_{IF-LoIn} - Pre-Mix. RF Input Power - dBm

P_{out} (MIX), RFL, ImL vs P_{RF-LoIn}
(at V_{CC} = 3.0 V, T_A = -30 °C)

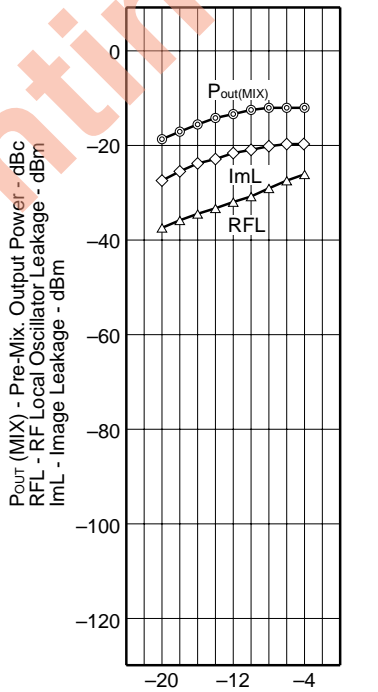

P_{IF-LoIn} - Pre-Mix. RF Input Power - dBm

P_{out} (MIX), RFL, ImL vs P_{RF-LoIn}
(at V_{CC} = 3.6 V, T_A = -30 °C)

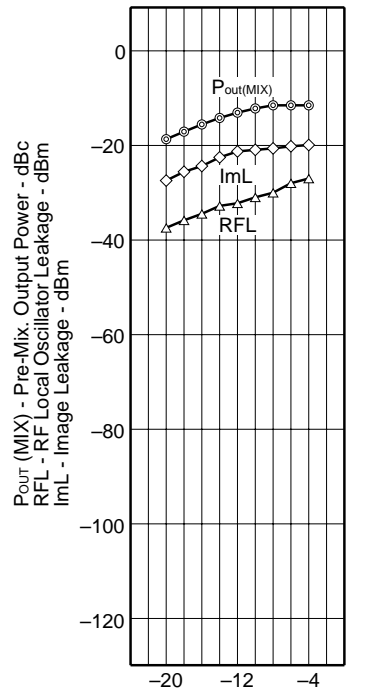

P_{IF-LoIn} - Pre-Mix. RF Input Power - dBm

P_{out} (MIX), RFL, ImL
 VS P_{RF-Loin}
 (at V_{CC} = 2.7 V, T_A = +25 °C)

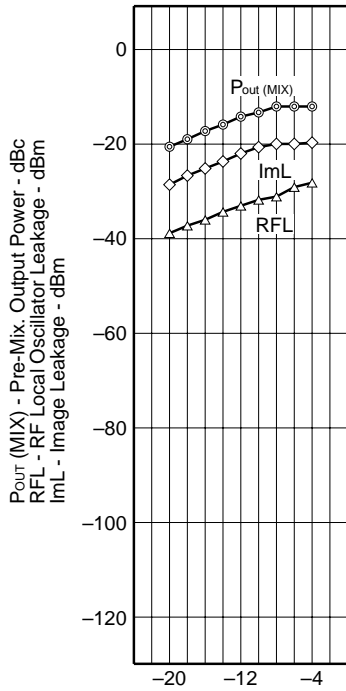

P_{RF-Loin} - Pre-Mix. RF Input Power - dBm

P_{out} (MIX), RFL, ImL
 VS P_{RF-Loin}
 (at V_{CC} = 3.0 V, T_A = +25 °C)

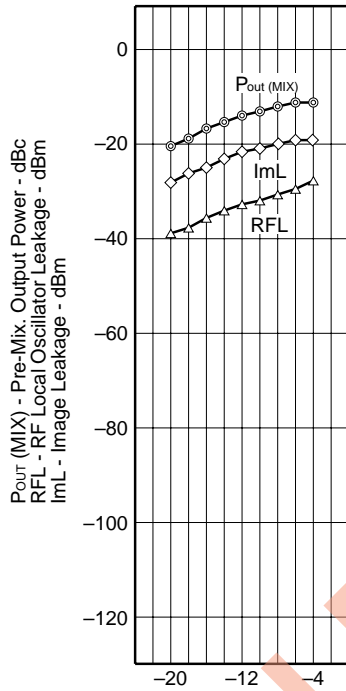

P_{RF-Loin} - Pre-Mix. RF Input Power - dBm

P_{out} (MIX), RFL, ImL
 VS P_{RF-Loin}
 (at V_{CC} = 3.6 V, T_A = +25 °C)

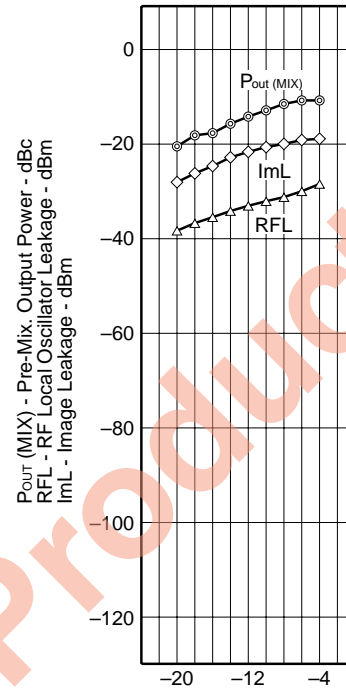

P_{RF-Loin} - Pre-Mix. RF Input Power - dBm

P_{out} (MIX), RFL, ImL
 VS P_{RF-Loin}
 (at V_{CC} = 2.7 V, T_A = +80 °C)

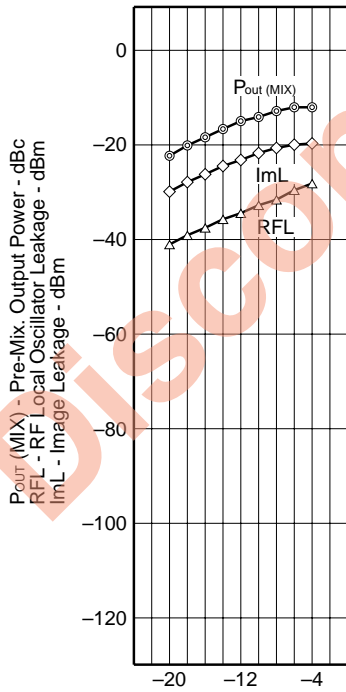

P_{RF-Loin} - Pre-Mix. RF Input Power - dBm

P_{out} (MIX), RFL, ImL
 VS P_{RF-Loin}
 (at V_{CC} = 3.0 V, T_A = +80 °C)

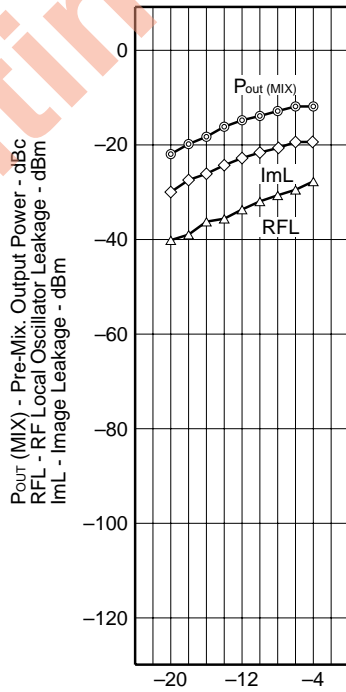

P_{RF-Loin} - Pre-Mix. RF Input Power - dBm

P_{out} (MIX), RFL, ImL
 VS P_{RF-Loin}
 (at V_{CC} = 3.6 V, T_A = +80 °C)

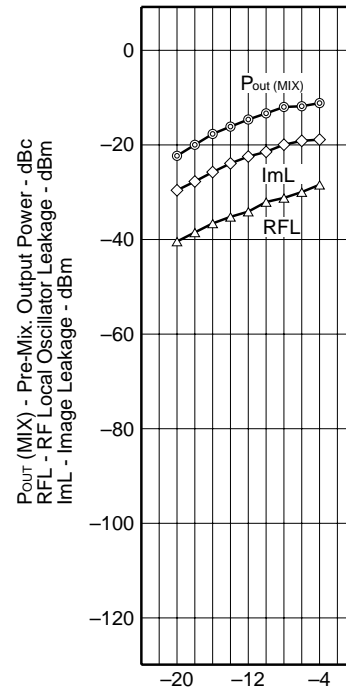

P_{RF-Loin} - Pre-Mix. RF Input Power - dBm

$P_{out}(MIX)$ vs f_{MIXout}
(at $V_{CC} = 2.7\text{ V}$, $T_A = -30\text{ }^\circ\text{C}$)

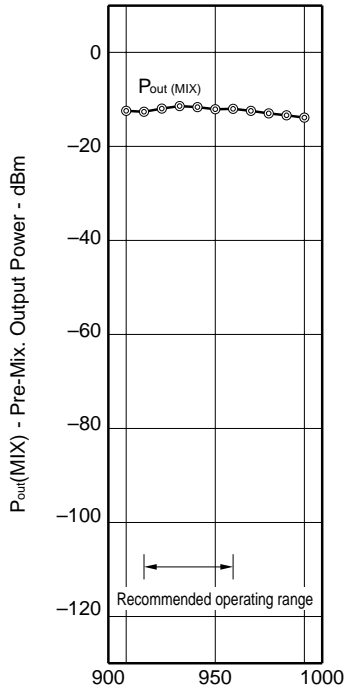

f_{MIXout} - Pre-Mix. Output Frequency - MHz

$P_{out}(MIX)$ vs f_{MIXout}
(at $V_{CC} = 3.0\text{ V}$, $T_A = -30\text{ }^\circ\text{C}$)

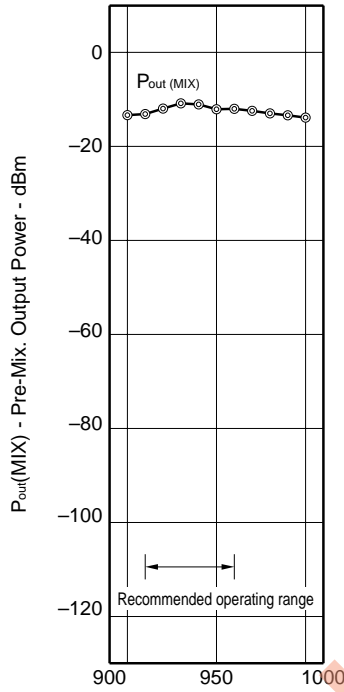

f_{MIXout} - Pre-Mix. Output Frequency - MHz

$P_{out}(MIX)$ vs f_{MIXout}
(at $V_{CC} = 3.6\text{ V}$, $T_A = -30\text{ }^\circ\text{C}$)

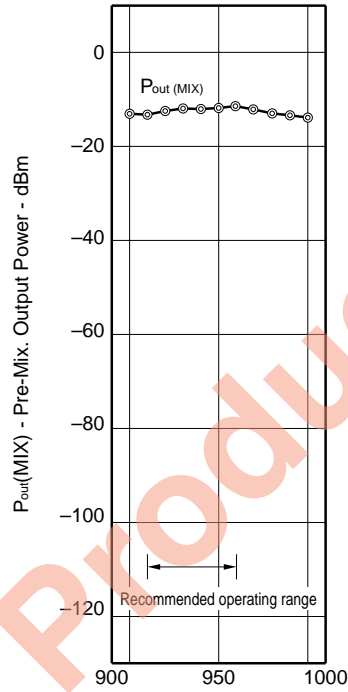

f_{MIXout} - Pre-Mix. Output Frequency - MHz

$P_{out}(MIX)$ vs f_{MIXout}
(at $V_{CC} = 2.7\text{ V}$, $T_A = +25\text{ }^\circ\text{C}$)

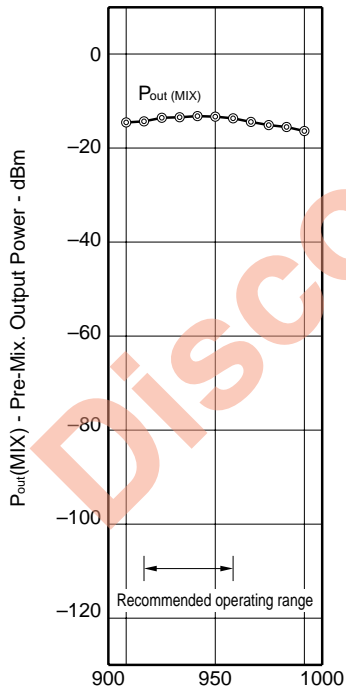

f_{MIXout} - Pre-Mix. Output Frequency - MHz

$P_{out}(MIX)$ vs f_{MIXout}
(at $V_{CC} = 3.0\text{ V}$, $T_A = +25\text{ }^\circ\text{C}$)

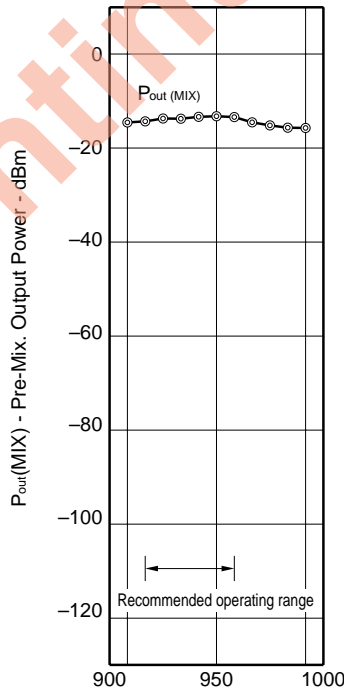

f_{MIXout} - Pre-Mix. Output Frequency - MHz

$P_{out}(MIX)$ vs f_{MIXout}
(at $V_{CC} = 3.6\text{ V}$, $T_A = +25\text{ }^\circ\text{C}$)

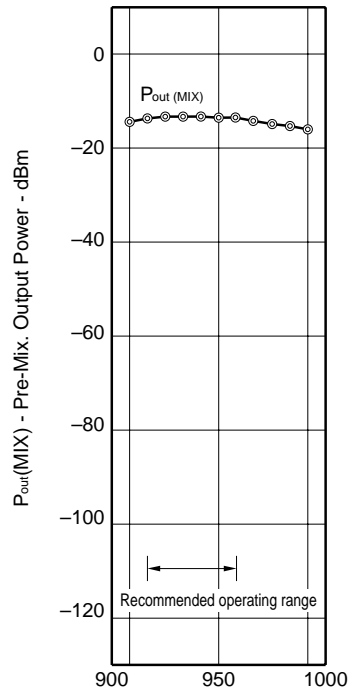

f_{MIXout} - Pre-Mix. Output Frequency - MHz

$P_{out}(MIX)$ vs f_{MIXout}
(at $V_{CC} = 2.7\text{ V}$, $T_A = +80\text{ }^\circ\text{C}$)

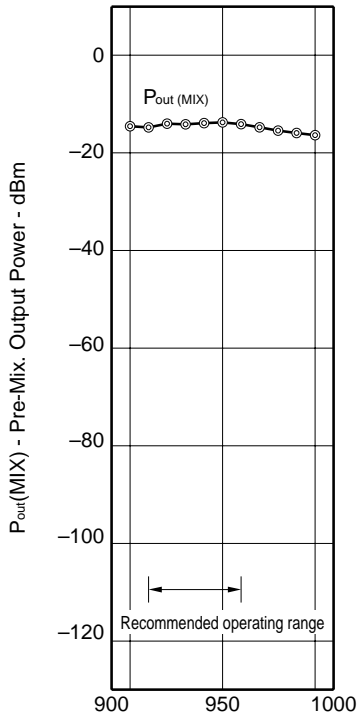

f_{MIXout} - Pre-Mix. Output Frequency - MHz

$P_{out}(MIX)$ vs f_{MIXout}
(at $V_{CC} = 3.0\text{ V}$, $T_A = +80\text{ }^\circ\text{C}$)

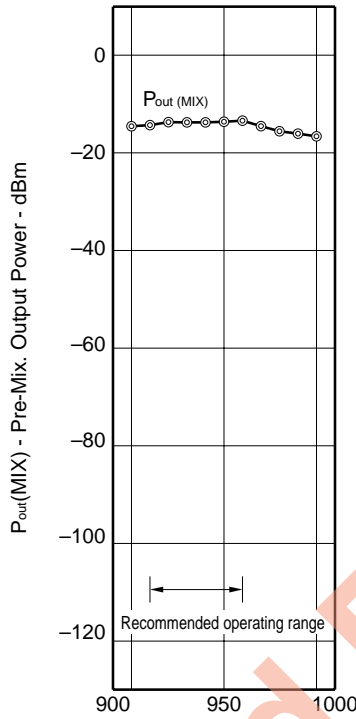

f_{MIXout} - Pre-Mix. Output Frequency - MHz

$P_{out}(MIX)$ vs f_{MIXout}
(at $V_{CC} = 3.6\text{ V}$, $T_A = +80\text{ }^\circ\text{C}$)

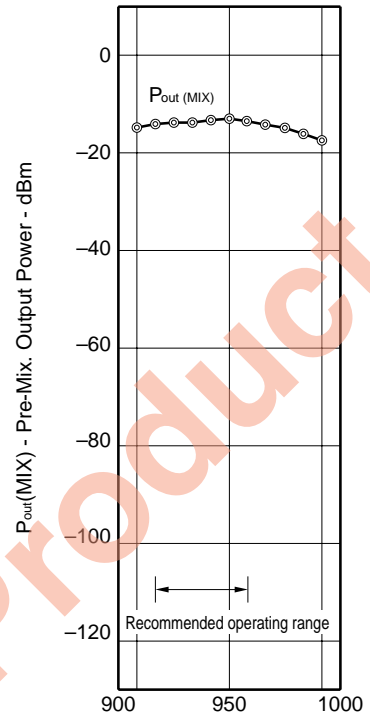

f_{MIXout} - Pre-Mix. Output Frequency - MHz

Discontinued Product

TEST CIRCUIT 1 (Modulator+Pre-Mixer / In case of V_{IQin} is single ended input)

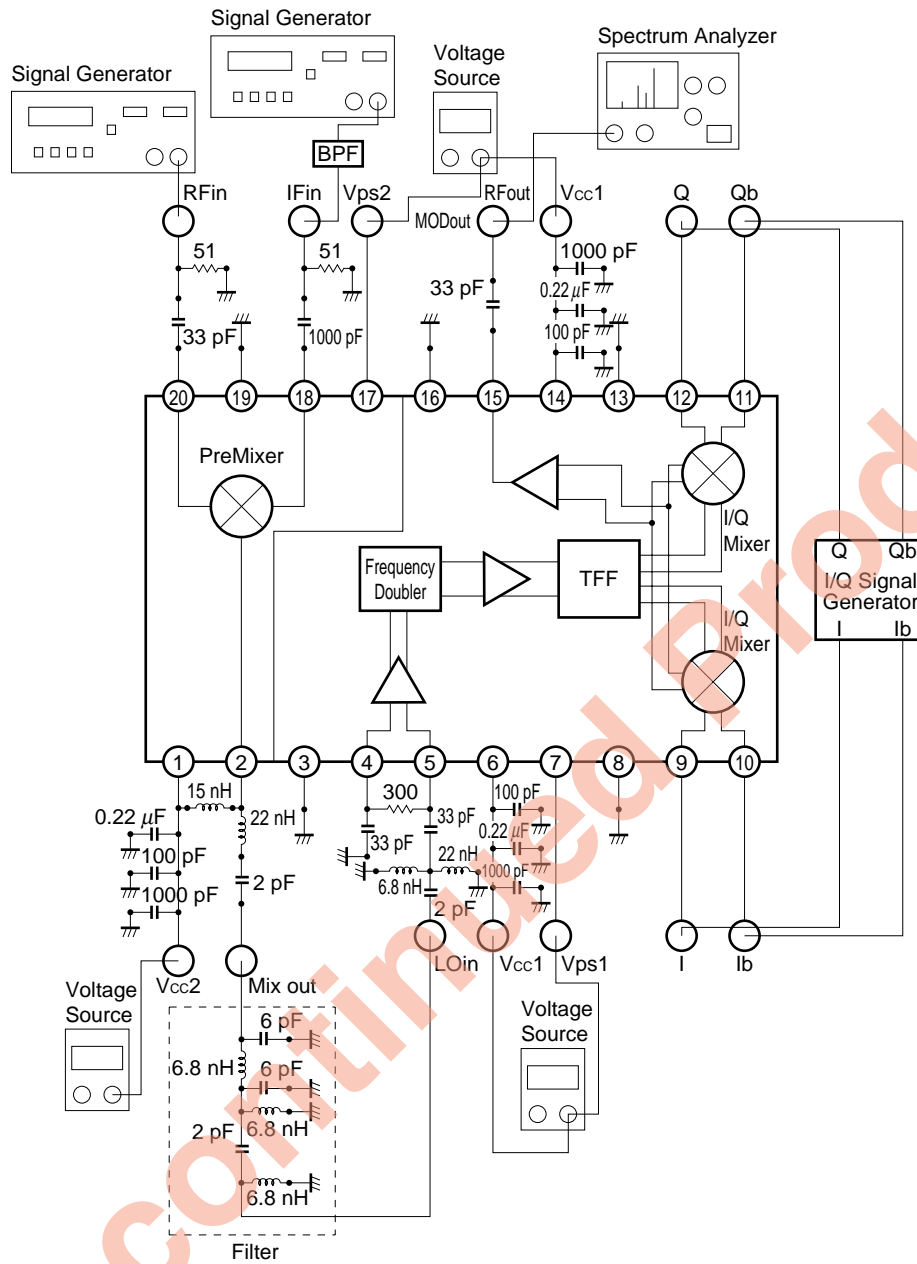

TEST CIRCUIT 3 (Pre-Mixer)

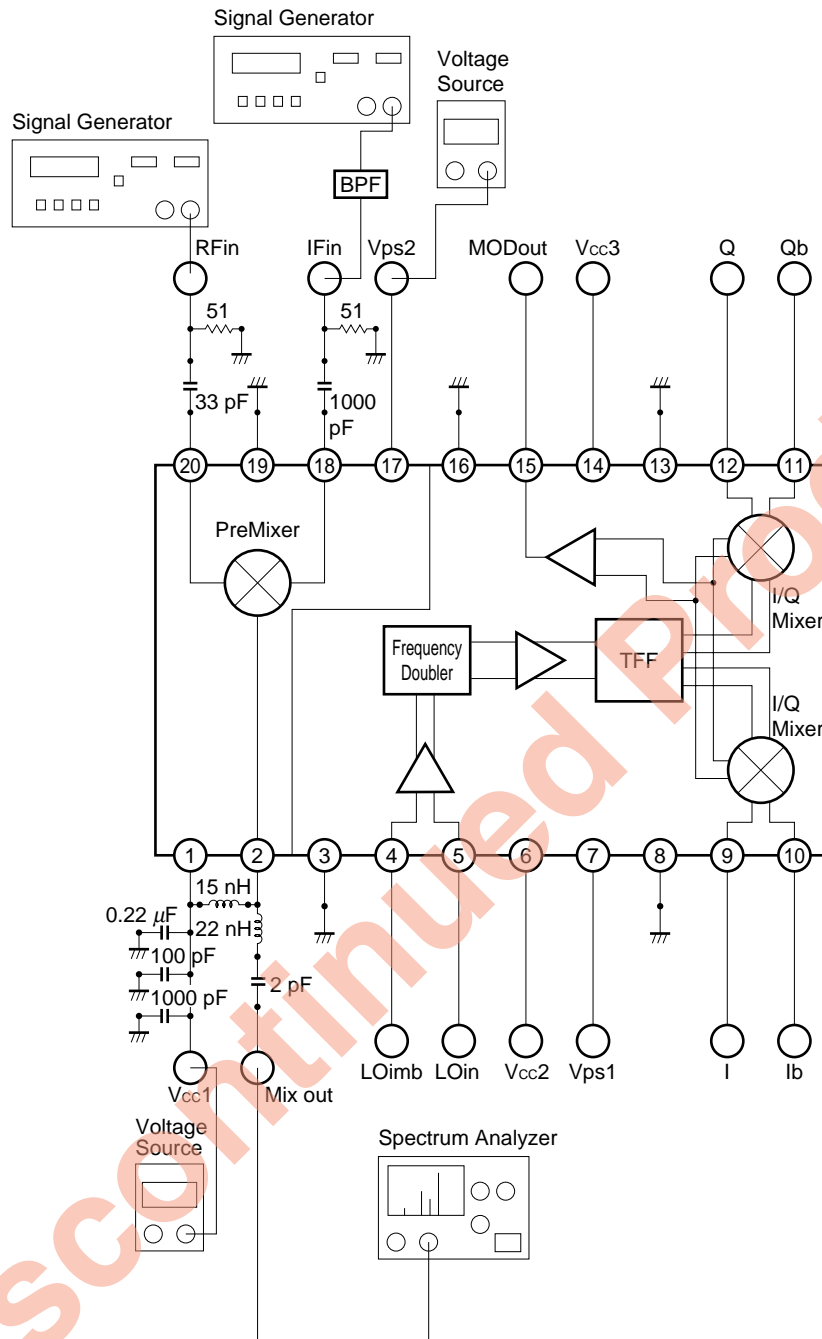

APPLICATION CIRCUIT EXAMPLE

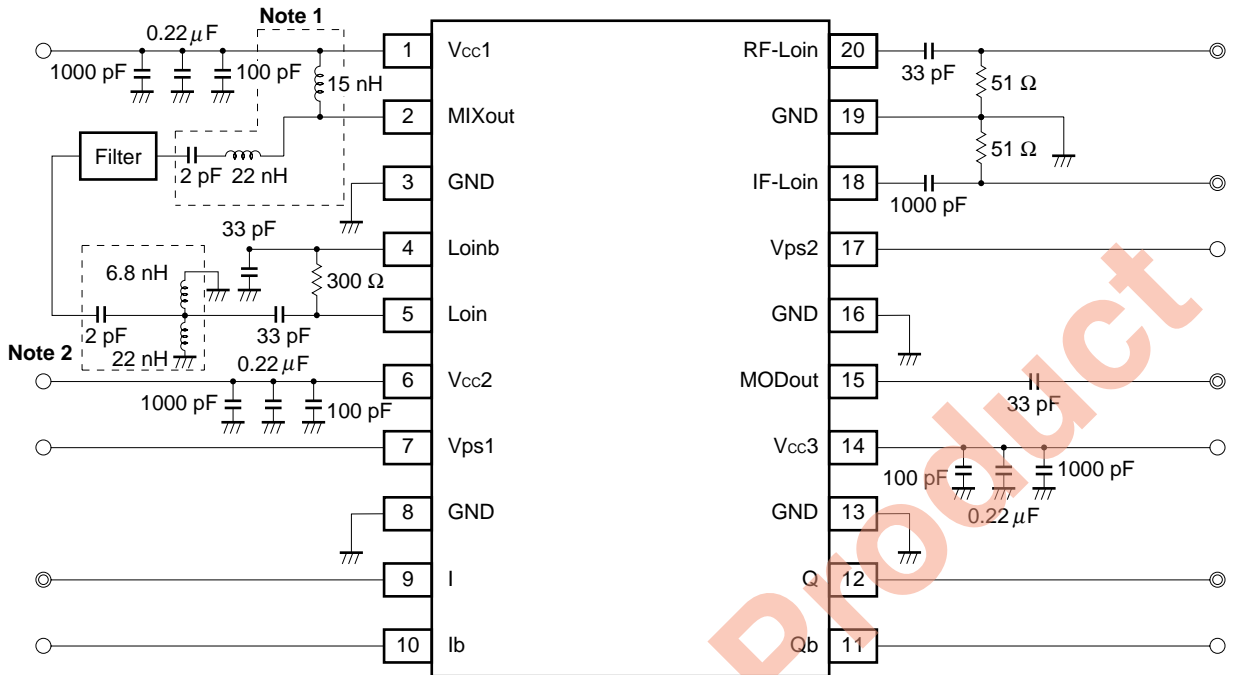
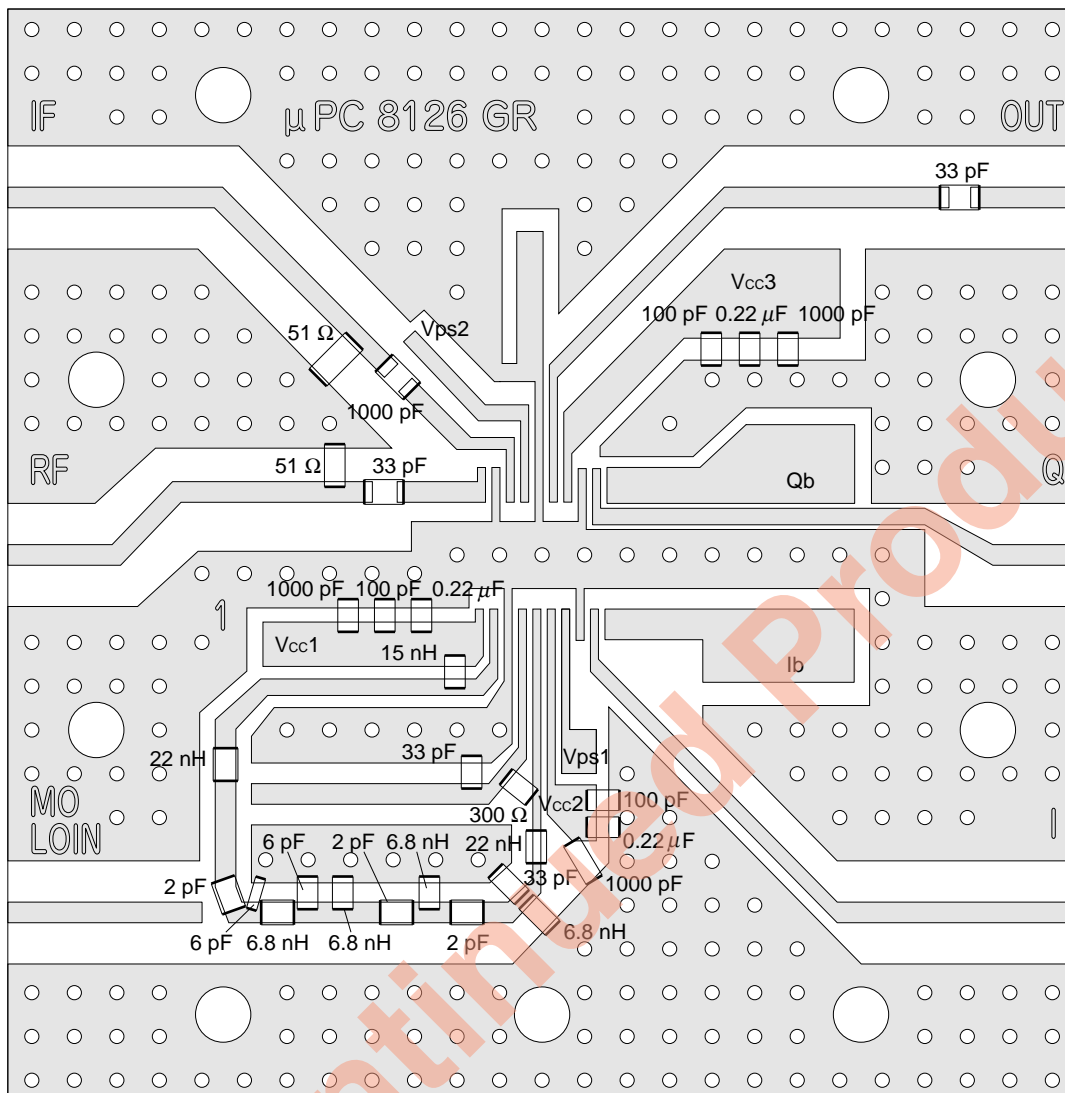

TABLE 1 : Example of filter connect between pin2 and pin5

Kind of filter	BPF	
Circuit		<p>fo = 948 MHz Insertion Loss = 3.5 dB</p>

- Notes**
- 50 Ω matching circuit at fMIXout = 948 MHz.
In case of using NEC's evaluation board.
 - 50 Ω matching circuit at fLoin = 948 MHz.
In case of using NEC's evaluation board.

EXAMPLE OF TEST CIRCUIT 1 ASSEMBLED ON EVALUATION BOARD



- Notes**
1. Double-sided patterning with 35 mm thick copper on polyimide board.
 2. GND pattern on backside.
 3. solder coating over patterns.
 4. ○, ○ indicate through-holes.

NOTICE The test circuits and board pattern on data sheet are for performance evaluation use only. In case of actual design-in, matching circuit should be determined using S-parameter of desired frequency in accordance to actual mounting pattern.

PACKAGE DIMENSIONS

★ 20 PIN PLASTIC SSOP (225 mil) (UNIT: mm)

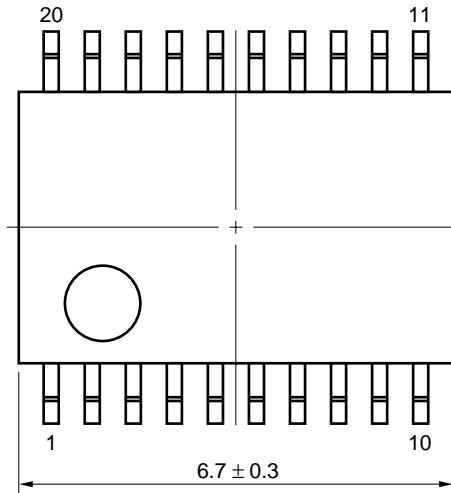

detail of lead end

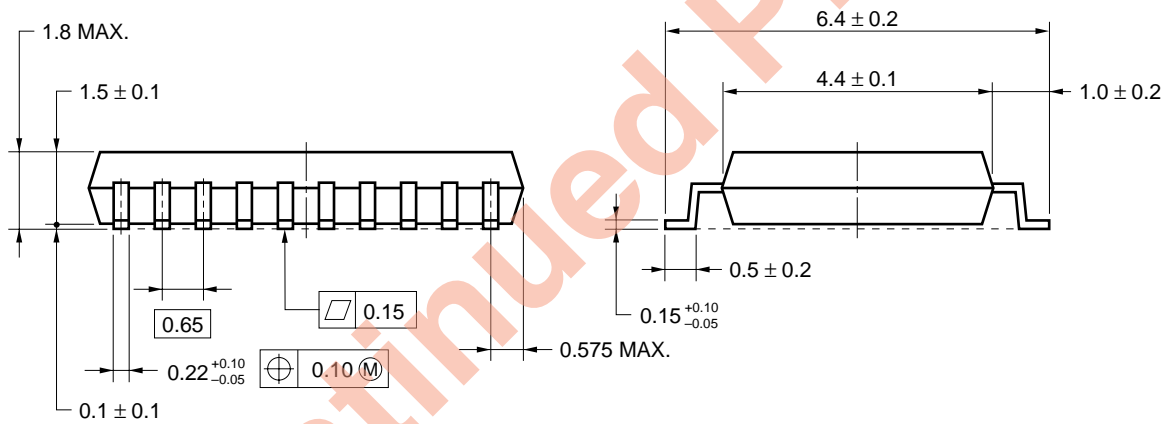
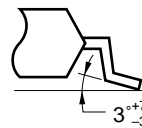

NOTE Each lead centerline is located within 0.10 mm of its true position (T.P.) at maximum material condition.

Discontinued Product

NOTE ON CORRECT USE

- (1) Observe precautions for handling because of electrostatic sensitive devices.
- (2) Form a ground pattern as widely as possible to minimize ground impedance (to prevent undesired oscillation).
- (3) Keep the track length of the ground pins as short as possible.
- (4) Connect a bypass capacitor (e.x. 1 000 pF) to the Vcc pin.

RECOMMENDED SOLDERING CONDITIONS

This product should be soldered in the following recommended conditions. Other soldering method and conditions than the recommended conditions are to be consulted with sales representatives.

μPC8126GR

Soldering process	Soldering conditions	Symbol
Infrared ray reflow	Peak package's surface temperature: 235 °C or below, Reflow time: 30 seconds or below (210 °C or higher) Number of reflow process: 2, Exposure limit ^{Note} : None	IR35-00-2
VPS	Peak package's surface temperature: 215 °C or below, Reflow time: 40 seconds or below (200 °C or higher) Number of reflow process: 2, Exposure limit ^{Note} : None	VP15-00-2
Wave soldering	Solder temperature: 260 °C or below, Flow time: 10 seconds or below, Number of flow process: 1, Exposure limit ^{Note} : None	WS60-00-1
Partial heating method	Terminal temperature: 300 °C or below, Flow time: 3 seconds/pin or below, Exposure limit ^{Note} : None	

Note Exposure limit before soldering after dry-pack package is opened.
Storage conditions: 25 °C and relative humidity at 65 % or less.

Caution Apply only a single process at once, except for “Partial heating method”.

For details of recommended soldering conditions for surface mounting, refer to information document SEMICONDUCTOR DEVICE MOUNTING TECHNOLOGY MANUAL (C10535E).

[MEMO]

Discontinued Product

- **The information in this document is subject to change without notice. Before using this document, please confirm that this is the latest version.**
 - No part of this document may be copied or reproduced in any form or by any means without the prior written consent of NEC Corporation. NEC Corporation assumes no responsibility for any errors which may appear in this document.
 - NEC Corporation does not assume any liability for infringement of patents, copyrights or other intellectual property rights of third parties by or arising from use of a device described herein or any other liability arising from use of such device. No license, either express, implied or otherwise, is granted under any patents, copyrights or other intellectual property rights of NEC Corporation or others.
 - Descriptions of circuits, software, and other related information in this document are provided for illustrative purposes in semiconductor product operation and application examples. The incorporation of these circuits, software, and information in the design of the customer's equipment shall be done under the full responsibility of the customer. NEC Corporation assumes no responsibility for any losses incurred by the customer or third parties arising from the use of these circuits, software, and information.
 - While NEC Corporation has been making continuous effort to enhance the reliability of its semiconductor devices, the possibility of defects cannot be eliminated entirely. To minimize risks of damage or injury to persons or property arising from a defect in an NEC semiconductor device, customers must incorporate sufficient safety measures in its design, such as redundancy, fire-containment, and anti-failure features.
 - NEC devices are classified into the following three quality grades:
 - "Standard", "Special", and "Specific". The Specific quality grade applies only to devices developed based on a customer designated "quality assurance program" for a specific application. The recommended applications of a device depend on its quality grade, as indicated below. Customers must check the quality grade of each device before using it in a particular application.
 - Standard: Computers, office equipment, communications equipment, test and measurement equipment, audio and visual equipment, home electronic appliances, machine tools, personal electronic equipment and industrial robots
 - Special: Transportation equipment (automobiles, trains, ships, etc.), traffic control systems, anti-disaster systems, anti-crime systems, safety equipment and medical equipment (not specifically designed for life support)
 - Specific: Aircraft, aerospace equipment, submersible repeaters, nuclear reactor control systems, life support systems or medical equipment for life support, etc.
- The quality grade of NEC devices is "Standard" unless otherwise specified in NEC's Data Sheets or Data Books. If customers intend to use NEC devices for applications other than those specified for Standard quality grade, they should contact an NEC sales representative in advance.