

**4-BIT SINGLE-CHIP MICROCONTROLLER WITH PLL FREQUENCY  
SYNTHESIZER CONTROLLER FOR PORTABLE FM/AM RADIO AND TV****DESCRIPTION**

The  $\mu$ PD17071GB-012 is a CMOS microcontroller with an on-chip PLL frequency synthesizer for receiving international FM and AM and Japanese TV broadcasting.

In addition, because it includes a prescaler (230 MHz MAX.), IF counter, and LCD controller/driver, it constitutes a high-performance, multi-function FM, AM, or TV tuner on a single chip.

Housed in a 56-pin QFP and driven by two dry cells at a low voltage ( $V_{DD} = 1.8$  to  $3.6$  V), the  $\mu$ PD17071GB-012 is ideal for creating a compact portable clock radio and radio cassette recorder.

**FEATURES**

- Preset memory  
Three bands: FM, AM, and Japanese TV (1 to 12 channels)  
10 stations for each band, totaling 30 stations
- Last channel memory  
One station for each band, totaling 3 stations
- Tuning function
  - Manual seek/auto seek
  - Auto store memory
  - Preset memory call
- LCD controller/driver  
(1/4 duty, 1/2 bias, 3.1-V driven, frame frequency: 62.5 Hz)
- Watch function  
12-hour or 24-hour indication
- Alarm function  
Outputs alarm sound at set time every day
- Sleep timer function  
Turns off radio after set time  
(Time can be set in a range of 30 to 120 minutes in units of 30 minutes.)
- Low-voltage operation  
 $V_{DD} = 1.8$  to  $3.6$  V

**ORDERING INFORMATION**

| Part Number             | Package  |
|-------------------------|--|
| $\mu$ PD17071GB-012-1A7 | 56-pin plastic QFP (10 × 10 mm, 0.65 mm pitch) |

The information in this document is subject to change without notice.

**FUNCTIONAL OUTLINE**

**Receive frequency, channel space, reference frequency, intermediate frequency, station detection mode**

(1/2)

| Region    | Band                 | Receive Frequency | Channel Space     | Reference Frequency | Intermediate Frequency | Station Detection Mode |                      |
|-----------|----------------------|-------------------|-------------------|---------------------|------------------------|------------------------|----------------------|
| Japan     | FM                   | 76.0 to 90.0 MHz  | 100 kHz           | 25 kHz              | -10.71 MHz             | IF only<br>IF and SD   |                      |
|           |                      | 76.0 to 108.0 MHz | 100 kHz           | 25 kHz              | -10.71 MHz             | IF only<br>IF and SD   |                      |
|           | AM                   | 522 to 1629 kHz   | 9 kHz             | 3 kHz               | 450 kHz                | IF only<br>IF and SD   |                      |
|           |                      |                   |                   |                     | 459 kHz                | IF only<br>IF and SD   |                      |
|           |                      |                   |                   |                     | 10.71 MHz              | IF only<br>IF and SD   |                      |
|           | TV                   | 1 to 12 ch        | —                 | 25 kHz              | -10.71 MHz             | IF only<br>IF and SD   |                      |
|           | U.S.A.               | FM                | 87.5 to 107.9 MHz | 200 kHz             | 25 kHz                 | 10.71 MHz              | IF only<br>IF and SD |
|           |                      |                   |                   | 100 kHz             | 25 kHz                 | 10.71 MHz              | IF only<br>IF and SD |
|           |                      | AM                | 530 to 1710 kHz   | 10 kHz              | 5 kHz                  | 450 kHz                | IF only<br>IF and SD |
|           |                      |                   |                   |                     |                        | 460 kHz                | IF only<br>IF and SD |
| 10.71 MHz |                      |                   |                   |                     |                        | IF only<br>IF and SD   |                      |
| China     |                      | FM                | 87.0 to 108.0 MHz | 100 kHz             | 25 kHz                 | 10.71 MHz              | IF only<br>IF and SD |
|           | 50 kHz               |                   |                   | 25 kHz              | 10.71 MHz              | IF only<br>IF and SD   |                      |
|           | AM                   | 522 to 1611 kHz   | 9 kHz             | 3 kHz               | 450 kHz                | IF only<br>IF and SD   |                      |
|           |                      |                   |                   |                     | 10.71 MHz              | IF only<br>IF and SD   |                      |
| Europe 1  | FM                   | 87.5 to 108.0 MHz | 50 kHz            | 25 kHz              | 10.71 MHz              | IF only<br>IF and SD   |                      |
|           |                      |                   |                   |                     | 10.71 MHz              | IF only<br>IF and SD   |                      |
|           | AM                   | 530 to 1620 kHz   | 10 kHz            | 5 kHz               | 450 kHz                | IF only                |                      |
|           |                      |                   |                   |                     | 459 kHz                | IF only                |                      |
|           |                      |                   |                   |                     | 10.71 MHz              | IF only                |                      |
|           |                      | 522 to 1629 kHz   | 9 kHz             | 3 kHz               | 450 kHz                | IF only<br>IF and SD   |                      |
|           |                      |                   |                   |                     | 459 kHz                | IF only<br>IF and SD   |                      |
| 10.71 MHz | IF only<br>IF and SD |                   |                   |                     |                        |                        |                      |
| Europe 2  | FM                   | 87.5 to 108.0 MHz | 50 kHz            | 25 kHz              | 10.71 MHz              | IF only<br>IF and SD   |                      |
|           |                      |                   |                   |                     | 10.71 MHz              | IF only<br>IF and SD   |                      |
|           | AM                   | 530 to 1620 kHz   | 10 kHz            | 5 kHz               | 450 kHz                | IF only                |                      |
|           |                      |                   |                   |                     | 459 kHz                | IF only                |                      |
|           |                      |                   |                   |                     | 10.71 MHz              | IF only                |                      |
|           |                      | 522 to 1629 kHz   | 9 kHz             | 3 kHz               | 450 kHz                | IF only<br>IF and SD   |                      |
|           |                      |                   |                   |                     | 459 kHz                | IF only<br>IF and SD   |                      |
| 10.71 MHz | IF only<br>IF and SD |                   |                   |                     |                        |                        |                      |

**Remark** The initial values in the preset memory differ between “Europe 1” and “Europe 2”.

| Setting of Pin Input |            |            |                      | Setting of Initialization Diode Switch |            |            |       |
|----------------------|------------|------------|----------------------|--|------------|------------|-------|
| 9k/10k SD            | AREA0      | AREA1      | Japan Wide 100k/200k | CHINA BAND                             | IFSEL0     | IFSEL1     | SD_IF |
| Don't care           | L          | L          | L                    | 0                                      | Don't care | Don't care | 0     |
| Don't care           | L          | L          | L                    | 0                                      | Don't care | Don't care | 1     |
| Don't care           | L          | L          | H                    | 0                                      | Don't care | Don't care | 0     |
| Don't care           | L          | L          | H                    | 0                                      | Don't care | Don't care | 1     |
| Don't care           | L          | L          | Don't care           | 0                                      | 0          | 0          | 0     |
| Don't care           | L          | L          | Don't care           | 0                                      | 0          | 0          | 1     |
| Don't care           | L          | L          | Don't care           | 0                                      | 1          | 0          | 0     |
| Don't care           | L          | L          | Don't care           | 0                                      | 1          | 0          | 1     |
| Don't care           | L          | L          | Don't care           | 0                                      | 0          | 1          | 0     |
| Don't care           | L          | L          | Don't care           | 0                                      | 0          | 1          | 1     |
| Don't care           | L          | L          | Don't care           | 0                                      | Don't care | Don't care | 0     |
| Don't care           | L          | L          | Don't care           | 0                                      | Don't care | Don't care | 1     |
| Don't care           | L          | H          | L                    | 0                                      | Don't care | Don't care | 0     |
| Don't care           | L          | H          | L                    | 0                                      | Don't care | Don't care | 1     |
| Don't care           | L          | H          | H                    | 0                                      | Don't care | Don't care | 0     |
| Don't care           | L          | H          | H                    | 0                                      | Don't care | Don't care | 1     |
| Don't care           | L          | H          | Don't care           | 0                                      | 0          | 0          | 0     |
| Don't care           | L          | H          | Don't care           | 0                                      | 0          | 0          | 1     |
| Don't care           | L          | H          | Don't care           | 0                                      | 1          | 0          | 0     |
| Don't care           | L          | H          | Don't care           | 0                                      | 1          | 0          | 1     |
| Don't care           | L          | H          | Don't care           | 0                                      | 0          | 1          | 0     |
| Don't care           | L          | H          | Don't care           | 0                                      | 0          | 1          | 1     |
| Don't care           | Don't care | Don't care | L                    | 1                                      | Don't care | Don't care | 0     |
| Don't care           | Don't care | Don't care | L                    | 1                                      | Don't care | Don't care | 1     |
| Don't care           | Don't care | Don't care | H                    | 1                                      | Don't care | Don't care | 0     |
| Don't care           | Don't care | Don't care | H                    | 1                                      | Don't care | Don't care | 1     |
| Don't care           | Don't care | Don't care | Don't care           | 1                                      | 0          | 0          | 0     |
| Don't care           | Don't care | Don't care | Don't care           | 1                                      | 0          | 0          | 1     |
| Don't care           | Don't care | Don't care | Don't care           | 1                                      | 0          | 1          | 0     |
| Don't care           | Don't care | Don't care | Don't care           | 1                                      | 0          | 1          | 1     |
| Don't care           | H          | L          | Don't care           | 0                                      | Don't care | Don't care | 0     |
| Don't care           | H          | L          | Don't care           | 0                                      | Don't care | Don't care | 1     |
| L                    | H          | L          | Don't care           | 0                                      | 0          | 0          | 0     |
| L                    | H          | L          | Don't care           | 0                                      | 1          | 0          | 0     |
| L                    | H          | L          | Don't care           | 0                                      | 0          | 1          | 0     |
| H                    | H          | L          | Don't care           | 0                                      | 0          | 0          | 0     |
| Don't care           | H          | L          | Don't care           | 0                                      | 0          | 0          | 1     |
| H                    | H          | L          | Don't care           | 0                                      | 1          | 0          | 0     |
| Don't care           | H          | L          | Don't care           | 0                                      | 1          | 0          | 1     |
| H                    | H          | L          | Don't care           | 0                                      | 0          | 1          | 0     |
| Don't care           | H          | L          | Don't care           | 0                                      | 0          | 1          | 1     |
| Don't care           | H          | H          | Don't care           | 0                                      | Don't care | Don't care | 0     |
| Don't care           | H          | H          | Don't care           | 0                                      | Don't care | Don't care | 1     |
| L                    | H          | H          | Don't care           | 0                                      | 0          | 0          | 0     |
| L                    | H          | H          | Don't care           | 0                                      | 1          | 0          | 0     |
| L                    | H          | H          | Don't care           | 0                                      | 0          | 1          | 0     |
| H                    | H          | H          | Don't care           | 0                                      | 0          | 0          | 0     |
| Don't care           | H          | H          | Don't care           | 0                                      | 0          | 0          | 1     |
| H                    | H          | H          | Don't care           | 0                                      | 1          | 0          | 0     |
| Don't care           | H          | H          | Don't care           | 0                                      | 1          | 0          | 1     |
| H                    | H          | H          | Don't care           | 0                                      | 0          | 1          | 0     |
| Don't care           | H          | H          | Don't care           | 0                                      | 0          | 1          | 1     |

Remarks 1. H: High-level input, L: Low-level input  
 2. 0: Open, 1: Short

**INITIAL VALUE OF PRESET MEMORY**

The contents of the preset memory on first power application differ depending on the destination region, as follows:

| Destination | Band          | Preset Memory |      |      |      |       |       |      |      |      |      |      |
|-------------|---------------|---------------|------|------|------|-------|-------|------|------|------|------|------|
|             |               | Last          | M1   | M2   | M3   | M4    | M5    | M6   | M7   | M8   | M9   | M10  |
| Japan       | FM (MHz)      | 77.5          | 77.5 | 80.0 | 82.5 | 85.0  | 87.5  | 76.0 | 90.0 | 76.0 | 76.0 | 76.0 |
|             | FM wide (MHz) | 76.0          | 76.0 | 90.0 | 98.0 | 106.0 | 108.0 | 76.0 | 90.0 | 76.0 | 76.0 | 76.0 |
|             | AM (kHz)      | 603           | 603  | 810  | 999  | 1440  | 1620  | 522  | 522  | 522  | 522  | 522  |
|             | TV (ch)       | 1 ch          | 1 ch | 3 ch | 4 ch | 8 ch  | 12 ch | 1 ch | 1 ch | 1 ch | 1 ch | 1 ch |
| U.S.A.      | FM100 k (MHz) | 87.5          | 87.5 | 90.0 | 98.0 | 106.0 | 108.0 | 87.5 | 87.5 | 87.5 | 87.5 | 87.5 |
|             | FM200 k (MHz) | 87.5          | 87.5 | 90.1 | 98.1 | 106.1 | 107.9 | 87.5 | 87.5 | 87.5 | 87.5 | 87.5 |
|             | AM (kHz)      | 530           | 530  | 600  | 1000 | 1200  | 1440  | 1710 | 530  | 530  | 530  | 530  |
| China       | FM (MHz)      | 87.0          | 87.0 | 87.0 | 87.0 | 87.0  | 87.0  | 87.0 | 87.0 | 87.0 | 87.0 | 87.0 |
|             | AM (kHz)      | 522           | 522  | 522  | 522  | 522   | 522   | 522  | 522  | 522  | 522  | 522  |
| Europe 1    | FM (MHz)      | 87.5          | 87.5 | 90.0 | 98.0 | 106.0 | 108.0 | 87.5 | 87.5 | 87.5 | 87.5 | 87.5 |
|             | AM9 k (kHz)   | 522           | 522  | 603  | 999  | 1440  | 1602  | 522  | 522  | 522  | 522  | 522  |
|             | AM10 k (kHz)  | 530           | 530  | 600  | 1000 | 1400  | 1610  | 530  | 530  | 530  | 530  | 530  |
| Europe 2    | FM (MHz)      | 87.5          | 87.5 | 90.1 | 98.1 | 106.1 | 108.0 | 87.5 | 87.5 | 87.5 | 87.5 | 87.5 |
|             | AM9 k (kHz)   | 522           | 522  | 603  | 999  | 1440  | 1602  | 522  | 522  | 522  | 522  | 522  |
|             | AM10 k (kHz)  | 530           | 530  | 600  | 1000 | 1400  | 1610  | 530  | 530  | 530  | 530  | 530  |

**Remark** The initial values in the preset memory differ between “Europe 1” and “Europe 2”.

**Tuning Function**

(1) Manual tuning

| Type                     | Description   |
|--------------------------|---|
| Manual up<br>Manual down | Increments or decrements frequency one step each time the corresponding key is pressed. |

(2) Auto tuning

| Type                 | Description  |
|----------------------|--|
| Seek up<br>Seek down | Searches station in up or down direction and, when station has been found, holds frequency of station. |

(3) Preset memory

Stores 10 stations for each band (FM, AM, and TV) by using 10 buttons, totaling 30 stations.

(4) Preset memory call

Receives the frequency written to the preset memory.

(5) Auto store memory

Searches all the frequencies in the received band, and automatically writes the frequencies of stations to the preset memory.

(6) Last channel memory

Stores the frequency of the station received last in each of the three bands (FM, AM, and TV), totaling three stations.

**WATCH FUNCTION**

- (1) 12-hour (with “AM” and “PM” indication) or 24-hour indication  
The time indication mode is automatically selected according to the selected destination region.
- (2) Time on power application  
On power application, the time is set to “00:00” (midnight) and counting is started.

**TIMER FUNCTION**

- (1) Alarm function  
Outputs an alarm sound at set time every day.
- (2) Sleep timer  
Automatically turns off radio after 30 to 120 minutes (the time can be set in units of 30 minutes).

**OTHERS**

- (1) Outputs beep sound to confirm valid momentary key input.
- (2) Watch/frequency (mode) indication selection
- (3) Mute control output
- (4) Key lock function

**PIN CONFIGURATION (Top View)**

56-pin plastic QFP (10 × 10 mm, 0.65-mm pitch)

μPD17071GB-012-1A7

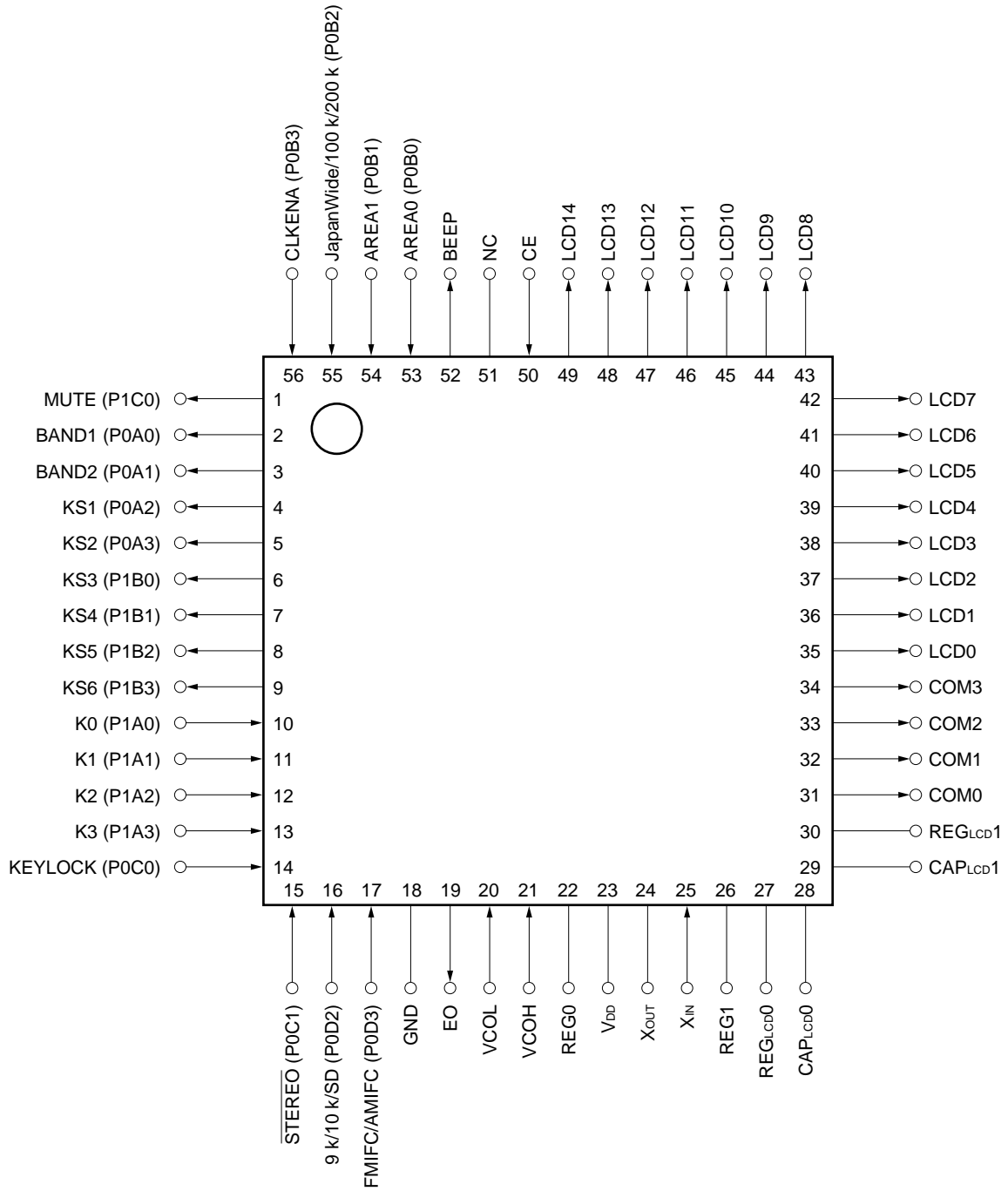

**Remark** ( ): Pins for μPD17071GB-XXX-1A7

**TABLE OF CONTENTS**

**1. PIN FUNCTION .....9**

**2. CONFIGURATION OF KEY MATRIX .....15**

**2.1 Layout of Initialization Diode Key Matrix .....15**

**2.2 Layout of Momentary Key Matrix .....15**

**2.3 Connection of Key Matrix .....16**

**2.4 Description of Key Matrix .....17**

        2.4.1 Initialization diode matrix .....17

        2.4.2 Momentary key .....20

**2.5 Alarm Function .....28**

**2.6 Key Lock Function .....29**

**3. LCD DISPLAY .....30**

**3.1 LCD Panel .....30**

**3.2 Font .....30**

**3.3 LCD Pattern .....30**

**3.4 LCD Pin Assignment .....31**

**3.5 Display Description .....33**

**3.6 Display Example .....34**

**4. MUTE OUTPUT TIMING CHART .....36**

**4.1 Manual up/down (operates by pressing key and releasing within 0.5 sec) .....36**

**4.2 Auto up/down (operates by holding down key for 0.5 sec or longer) .....36**

**4.3 Calling Preset Memory .....37**

**4.4 Band Selection .....37**

**4.5 CE Pin .....37**

        4.5.1 High level to low level .....37

        4.5.2 Low level to high level .....37

**4.6 Sleep Timer .....38**

**5. ELECTRICAL SPECIFICATIONS (PRELIMINARY) .....39**

**6. PACKAGE .....42**



1. PIN FUNCTION

| Pin No.              | Symbol          | Pin Name                  | Description  | I/O Form              |       |       |    |   |   |    |   |   |                |   |   |                 |   |   |                       |
|----------------------|-----------------|---------------------------|--|-----------------------|-------|-------|----|---|---|----|---|---|----------------|---|---|-----------------|---|---|-----------------------|
| 1                    | MUTE            | Mute output               | <p>Outputs a mute control signal.</p> <p>Outputs a high level in the following cases:</p> <ul style="list-style-type: none"> <li>• When radio is turned ON/OFF</li> <li>• When the frequency band is changed</li> <li>• During manual tuning</li> <li>• During auto tuning</li> <li>• When the preset memory is called</li> <li>• In power-off state</li> </ul>  | CMOS push-pull output |       |       |    |   |   |    |   |   |                |   |   |                 |   |   |                       |
| 2<br>3               | BAND1<br>BAND2  | Band select signal output | <p>These pins output band select signals.</p> <p>The output of each band is as follows:</p> <table border="1" style="margin-left: auto; margin-right: auto;"> <thead> <tr> <th style="text-align: center;">Pin<br/>Selected band</th> <th style="text-align: center;">BAND1</th> <th style="text-align: center;">BAND2</th> </tr> </thead> <tbody> <tr> <td style="text-align: center;">AM</td> <td style="text-align: center;">0</td> <td style="text-align: center;">0</td> </tr> <tr> <td style="text-align: center;">FM</td> <td style="text-align: center;">1</td> <td style="text-align: center;">0</td> </tr> <tr> <td style="text-align: center;">TV (1 to 3 ch)</td> <td style="text-align: center;">1</td> <td style="text-align: center;">1</td> </tr> <tr> <td style="text-align: center;">TV (4 to 12 ch)</td> <td style="text-align: center;">1</td> <td style="text-align: center;">1</td> </tr> </tbody> </table> <p>(0: Low level, 1: High level)</p> | Pin<br>Selected band  | BAND1 | BAND2 | AM | 0 | 0 | FM | 1 | 0 | TV (1 to 3 ch) | 1 | 1 | TV (4 to 12 ch) | 1 | 1 | CMOS push-pull output |
| Pin<br>Selected band | BAND1           | BAND2                     |  |                       |       |       |    |   |   |    |   |   |                |   |   |                 |   |   |                       |
| AM                   | 0               | 0                         |  |                       |       |       |    |   |   |    |   |   |                |   |   |                 |   |   |                       |
| FM                   | 1               | 0                         |  |                       |       |       |    |   |   |    |   |   |                |   |   |                 |   |   |                       |
| TV (1 to 3 ch)       | 1               | 1                         |  |                       |       |       |    |   |   |    |   |   |                |   |   |                 |   |   |                       |
| TV (4 to 12 ch)      | 1               | 1                         |  |                       |       |       |    |   |   |    |   |   |                |   |   |                 |   |   |                       |
| 4<br> <br>9          | KS1<br> <br>KS6 | Key source output         | Key source output pins of a key matrix   | CMOS push-pull output |       |       |    |   |   |    |   |   |                |   |   |                 |   |   |                       |
| 10<br> <br>13        | K0<br> <br>K3   | Key return signal input   | These pins input the key return signals of a key matrix. They are connected to an internal pull-down resistor.   | Input                 |       |       |    |   |   |    |   |   |                |   |   |                 |   |   |                       |
| 14                   | KEYLOCK         | Key lock signal input     | <p>This pin inputs a key lock signal.</p> <p>The signal input to this pin is used to lock or unlock a momentary key.</p> <p>Input a signal to this pin as follows:</p> <ul style="list-style-type: none"> <li>• High level: To lock the momentary key.</li> </ul> <p>All momentary keys are invalid while the keys are locked.</p> <ul style="list-style-type: none"> <li>• Low level: To unlock the keys.</li> </ul> <p>Note, however, that a high level or low level of less than 32 ms is invalid.</p>  | Input                 |       |       |    |   |   |    |   |   |                |   |   |                 |   |   |                       |
| 15                   | STEREO          | Stereo signal input       | <p>This pin inputs a stereo signal.</p> <p>Reception of stereo broadcasting is identified by the signal input to this pin.</p> <p>Input a low level to this pin while stereo broadcasting is being received.</p>   | Input                 |       |       |    |   |   |    |   |   |                |   |   |                 |   |   |                       |

| Pin No. | Symbol                    | Pin Name                             | Description   | I/O Form |                           |                           |    |                   |  |    |                 |                     |    |                   |  |        |        |                          |   |   |                           |   |   |                           |   |   |                           |       |
|---------|---------------------------|--------------------------------------|---|----------|---------------------------|---------------------------|----|-------------------|--|----|-----------------|---------------------|----|-------------------|--|--------|--------|--------------------------|---|---|---------------------------|---|---|---------------------------|---|---|---------------------------|-------|
| 16      | 9 k/10 k /SD              | AM setting input/<br>SD signal input | <p>This pin inputs an SD (Station Detector) signal.<br/>When “Europe 1” or “Europe 2” is selected as the destination region, this pin can be also used to input setting of a channel space in an AM band.</p> <p><b>(1) Setting of channel space in AM band for “Europe 1” and “Europe 2” (9 k/10k)</b><br/>This setting is valid only when “Europe 1” or “Europe 2” is selected as the destination region.<br/>The setting is read only on power application (power-ON reset), or when the signal input to the CE pin (pin 50) goes high (CE reset); otherwise, it is ignored.<br/>Input a signal to this pin as follows:</p> <ul style="list-style-type: none"> <li>• High level: Channel space 9 kHz</li> <li>• Low level: Channel space 10 kHz</li> </ul> <p>Note that the setting of this pin is invalid when initialization diode switch SD_IF = 1, and the channel space is 9 kHz.</p> <p><b>(2) Input of SD signal (SD)</b><br/>When a station has been detected this is identified by the signal input to this pin and the frequency counter when initialization diode switch SD_IF = 1.<br/>Input a high level to this pin when a station is detected.<br/>However, a signal input for less than 32 ms is invalid.</p>  | Input    |                           |                           |    |                   |  |    |                 |                     |    |                   |  |        |        |                          |   |   |                           |   |   |                           |   |   |                           |       |
| 17      | FMIFC /AMIFC              | FM/AM intermediate frequency input   | <p>This pin inputs an intermediate frequency (IF) in an FM or AM band.<br/>The signal input to this pin is used to identify a station.<br/>When initialization diode switch SD_IF = 1, however, the signal input to this pin and the signal input to the SD pin (pin 16) are used to identify a station.<br/>The range of the input frequency in which detection of a station is identified is as follows:</p> <table border="1" style="margin-left: auto; margin-right: auto;"> <thead> <tr> <th>Band</th> <th>Input frequency range &lt;1&gt;</th> <th>Input frequency range &lt;2&gt;</th> </tr> </thead> <tbody> <tr> <td>FM</td> <td colspan="2" style="text-align: center;">10.7 MHz ± 20 kHz</td> </tr> <tr> <td>AM</td> <td style="text-align: center;">450 kHz ± 1 kHz</td> <td style="text-align: center;">459/460 kHz ± 1 kHz</td> </tr> <tr> <td>TV</td> <td colspan="2" style="text-align: center;">10.7 MHz ± 20 kHz</td> </tr> </tbody> </table> <p>The conditions of input frequency ranges &lt;1&gt; and &lt;2&gt; vary as follows depending on the setting of initialization diodes IFSEL1 and IFSEL2.</p> <table border="1" style="margin-left: auto; margin-right: auto;"> <thead> <tr> <th>IFSEL1</th> <th>IFSEL2</th> <th>Selected frequency range</th> </tr> </thead> <tbody> <tr> <td style="text-align: center;">0</td> <td style="text-align: center;">0</td> <td>Input frequency range &lt;1&gt;</td> </tr> <tr> <td style="text-align: center;">1</td> <td style="text-align: center;">0</td> <td>Input frequency range &lt;2&gt;</td> </tr> <tr> <td style="text-align: center;">0</td> <td style="text-align: center;">1</td> <td>Input frequency range &lt;1&gt;</td> </tr> </tbody> </table> <p>(0: Open, 1: Short)</p> | Band     | Input frequency range <1> | Input frequency range <2> | FM | 10.7 MHz ± 20 kHz |  | AM | 450 kHz ± 1 kHz | 459/460 kHz ± 1 kHz | TV | 10.7 MHz ± 20 kHz |  | IFSEL1 | IFSEL2 | Selected frequency range | 0 | 0 | Input frequency range <1> | 1 | 0 | Input frequency range <2> | 0 | 1 | Input frequency range <1> | Input |
| Band    | Input frequency range <1> | Input frequency range <2>            |   |          |                           |                           |    |                   |  |    |                 |                     |    |                   |  |        |        |                          |   |   |                           |   |   |                           |   |   |                           |       |
| FM      | 10.7 MHz ± 20 kHz         |                                      |   |          |                           |                           |    |                   |  |    |                 |                     |    |                   |  |        |        |                          |   |   |                           |   |   |                           |   |   |                           |       |
| AM      | 450 kHz ± 1 kHz           | 459/460 kHz ± 1 kHz                  |   |          |                           |                           |    |                   |  |    |                 |                     |    |                   |  |        |        |                          |   |   |                           |   |   |                           |   |   |                           |       |
| TV      | 10.7 MHz ± 20 kHz         |                                      |   |          |                           |                           |    |                   |  |    |                 |                     |    |                   |  |        |        |                          |   |   |                           |   |   |                           |   |   |                           |       |
| IFSEL1  | IFSEL2                    | Selected frequency range             |   |          |                           |                           |    |                   |  |    |                 |                     |    |                   |  |        |        |                          |   |   |                           |   |   |                           |   |   |                           |       |
| 0       | 0                         | Input frequency range <1>            |   |          |                           |                           |    |                   |  |    |                 |                     |    |                   |  |        |        |                          |   |   |                           |   |   |                           |   |   |                           |       |
| 1       | 0                         | Input frequency range <2>            |   |          |                           |                           |    |                   |  |    |                 |                     |    |                   |  |        |        |                          |   |   |                           |   |   |                           |   |   |                           |       |
| 0       | 1                         | Input frequency range <1>            |   |          |                           |                           |    |                   |  |    |                 |                     |    |                   |  |        |        |                          |   |   |                           |   |   |                           |   |   |                           |       |
| 18      | GND                       | Ground                               | Ground pin  |          |                           |                           |    |                   |  |    |                 |                     |    |                   |  |        |        |                          |   |   |                           |   |   |                           |   |   |                           |       |

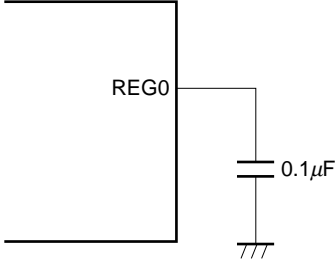
| Pin No.                         | Symbol                                | Pin Name                   | Description  | I/O Form                        |                                       |                          |           |         |     |                      |          |     |       |
|---------------------------------|---------------------------------------|----------------------------|--|---------------------------------|---------------------------------------|--------------------------|-----------|---------|-----|----------------------|----------|-----|-------|
| 19                              | EO                                    | Error out                  | <p>This pin outputs PLL (Phase Locked Loop) errors. It outputs the result of comparison between the frequency input to the VCOH (pin 21) or VCOL (pin 20) and a set frequency.</p> <ul style="list-style-type: none"> <li>• Input frequency &gt; Set frequency: High level</li> <li>• Input frequency &lt; Set frequency: Low level</li> <li>• Input frequency = Set frequency: Floating</li> </ul> <p>Connect this pin to a varactor diode via an external LPF (lowpass filter).</p>  | CMOS 3-state output             |                                       |                          |           |         |     |                      |          |     |       |
| 20                              | VCOL                                  | AM local oscillation input | <p>This pin inputs local oscillation output (VCO output) in an AM band. The signal that can be input to this pin is as follows:</p> <table border="1"> <thead> <tr> <th>Selected intermediate frequency</th> <th>Frequency range (MHz)</th> <th>Minimum amplitude (Vp-p)</th> </tr> </thead> <tbody> <tr> <td>10.71 MHz</td> <td>5 to 50</td> <td>0.2</td> </tr> <tr> <td>Other than 10.71 MHz</td> <td>0.3 to 8</td> <td>0.2</td> </tr> </tbody> </table> <p>Because an internal AC amplifier is provided, cut the DC component of the input signal with a capacitor.</p> | Selected intermediate frequency | Frequency range (MHz)                 | Minimum amplitude (Vp-p) | 10.71 MHz | 5 to 50 | 0.2 | Other than 10.71 MHz | 0.3 to 8 | 0.2 | Input |
| Selected intermediate frequency | Frequency range (MHz)                 | Minimum amplitude (Vp-p)   |  |                                 |                                       |                          |           |         |     |                      |          |     |       |
| 10.71 MHz                       | 5 to 50                               | 0.2                        |  |                                 |                                       |                          |           |         |     |                      |          |     |       |
| Other than 10.71 MHz            | 0.3 to 8                              | 0.2                        |  |                                 |                                       |                          |           |         |     |                      |          |     |       |
| 21                              | VCOH                                  | FM local oscillation input | <p>This pin inputs local oscillation output (VCO output) in an FM and TV band. The signal that can be input to this pin is as follows:</p> <table border="1"> <thead> <tr> <th>Frequency range (MHz)</th> <th>Minimum amplitude (V<sub>p-p</sub>)</th> </tr> </thead> <tbody> <tr> <td>4 to 230</td> <td>0.2</td> </tr> </tbody> </table> <p>Because an internal AC amplifier is provided, cut the DC component of the input signal with a capacitor.</p>  | Frequency range (MHz)           | Minimum amplitude (V <sub>p-p</sub> ) | 4 to 230                 | 0.2       | Input   |     |                      |          |     |       |
| Frequency range (MHz)           | Minimum amplitude (V <sub>p-p</sub> ) |                            |  |                                 |                                       |                          |           |         |     |                      |          |     |       |
| 4 to 230                        | 0.2                                   |                            |  |                                 |                                       |                          |           |         |     |                      |          |     |       |
| 22                              | REG0                                  | Power supply pin           | <p>This is a voltage regulator pin for PLL. Connect this pin to GND via a 0.1-μF capacitor. It outputs a low level when the radio is off.</p>    | —                               |                                       |                          |           |         |     |                      |          |     |       |
| 23                              | V <sub>DD</sub>                       | Power supply pin           | <p>This is a power supply pin. It supplies a voltage of V<sub>DD</sub> = 1.8 to 3.6 V (T<sub>A</sub> = -20 to +70 °C) to operate all the functions. Do not apply a voltage higher than that applied to the V<sub>DD</sub> pin to any pin other than the V<sub>DD</sub> pin.</p>  | —                               |                                       |                          |           |         |     |                      |          |     |       |
| 24                              | X <sub>OUT</sub>                      | Crystal resonator          | <p>These pins are used to connect a crystal resonator for system clock oscillation. Connect a 75-kHz crystal resonator across these pins.</p>  | CMOS push-pull                  |                                       |                          |           |         |     |                      |          |     |       |
| 25                              | X <sub>IN</sub>                       |                            | <p>The accuracy of the watch is affected only by the oscillation frequency of the crystal resonator.</p>   | —                               |                                       |                          |           |         |     |                      |          |     |       |

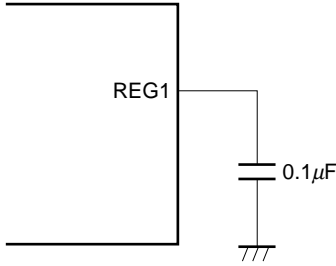
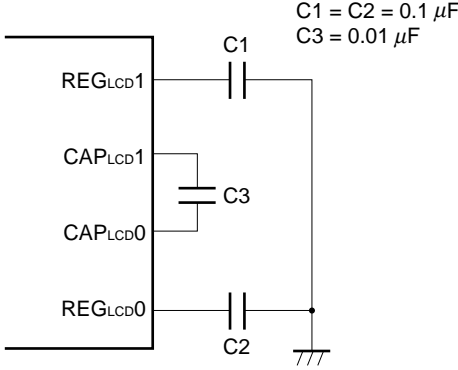
| Pin No.              | Symbol   | Pin Name                      | Description  | I/O Form              |
|----------------------|--|-------------------------------|--|-----------------------|
| 26                   | REG1   | Power supply pin              | <p>This pin is a voltage regulator pin for oscillation circuit. Connect this pin to GND via a 0.1-μF capacitor.</p>    | —                     |
| 27<br>28<br>29<br>30 | REG <sub>Lcd0</sub><br>CAP <sub>Lcd0</sub><br>CAP <sub>Lcd1</sub><br>REG <sub>Lcd1</sub> | LCD driving power supply pins | <ul style="list-style-type: none"> <li>• REG<sub>Lcd1</sub> and REG<sub>Lcd0</sub></li> <li>• These pins supply the LCD driving voltage.</li> <li>• CAP<sub>Lcd1</sub> and CAP<sub>Lcd0</sub></li> <li>• Connect a capacitor for a doubler circuit across these pins to create an LCD driving voltage.</li> <li>• Connect the capacitor as shown below to create the doubler circuit.</li> </ul>  <p><b>Caution</b> The value of the LCD drive voltage changes if the values of C1, C2, and C3 are changed because of the configuration of the doubler circuit.</p> | —                     |
| 31<br> <br>34        | COM0<br> <br>COM3  | LCD common signal output      | <p>These pins output common signals to an LCD panel. They output 60 dots on the LCD panel by creating a matrix with LCD0 through LCD14 pins (pins 35 through 49).</p>  | CMOS push-pull output |
| 35<br> <br>49        | LCD0<br> <br>LCD14   | LCD segment signal output     | <p>These pins outputs segment signals to an LCD panel. They display 60 dots on the LCD panel by creating a matrix with COM0 through COM3 pins (pins 31 through 34).</p>  | CMOS push-pull output |
| 50                   | CE   | Chip enable                   | <p>This input pins selects radio operation as follows:</p> <ul style="list-style-type: none"> <li>• High level<br/>Turns ON the radio.</li> <li>• Low level<br/>Turns OFF the radio.</li> </ul> <p>Note, however, that a high or low level of less than 200 μs is not accepted.</p>  | Input                 |
| 51                   | NC   | No connection                 | No connection. Externally pull down this pin.  | —                     |

| Pin No.  | Symbol         | Pin Name                         | Description  | I/O Form              |       |                    |   |   |       |   |   |        |   |   |          |   |   |          |       |
|----------|----------------|----------------------------------|--|-----------------------|-------|--------------------|---|---|-------|---|---|--------|---|---|----------|---|---|----------|-------|
| 52       | BEEP           | BEEP/ALARM output                | <p>This pin outputs a key-ON confirmation sound (beep output) and alarm sound.</p> <p><b>(1) Beep output</b><br/>                     A pulse of 1.5 kHz is output for about 40 ms in the following cases:</p> <ul style="list-style-type: none"> <li>• When a valid key is input</li> <li>• While time is adjusted up or down in high-speed mode</li> <li>• During seek up/down</li> </ul> <p><b>(2) Alarm sound output</b><br/>                     When the time reaches the alarm time set, a 3 kHz pulse is intermittently output approximately every 64 ms, five times after 1 second.<br/>                     The alarm sound is output for 10 minutes from the start of output, or until it is canceled.</p>  | CMOS push-pull output |       |                    |   |   |       |   |   |        |   |   |          |   |   |          |       |
| 53<br>54 | AREA0<br>AREA1 | Destination region setting input | <p>These pins input setting for the destination region.<br/>                     The setting of these pins is read only on application of V<sub>DD</sub> (power-ON reset) or when the signal input to the CE pin goes high (CE reset); otherwise, it is ignored.<br/>                     Input a signal to these pins as follows:</p> <table border="1" style="margin-left: auto; margin-right: auto;"> <thead> <tr> <th>AREA0</th> <th>AREA1</th> <th>Destination region</th> </tr> </thead> <tbody> <tr> <td>0</td> <td>0</td> <td>Japan</td> </tr> <tr> <td>0</td> <td>1</td> <td>U.S.A.</td> </tr> <tr> <td>1</td> <td>0</td> <td>Europe 1</td> </tr> <tr> <td>1</td> <td>1</td> <td>Europe 2</td> </tr> </tbody> </table> <p>(0: Low level, 1: High level)<br/>                     When initialization diode switch CHINA_BAND = 1, however, the setting is invalid, and the destination region is China.</p> | AREA0                 | AREA1 | Destination region | 0 | 0 | Japan | 0 | 1 | U.S.A. | 1 | 0 | Europe 1 | 1 | 1 | Europe 2 | Input |
| AREA0    | AREA1          | Destination region               |  |                       |       |                    |   |   |       |   |   |        |   |   |          |   |   |          |       |
| 0        | 0              | Japan                            |  |                       |       |                    |   |   |       |   |   |        |   |   |          |   |   |          |       |
| 0        | 1              | U.S.A.                           |  |                       |       |                    |   |   |       |   |   |        |   |   |          |   |   |          |       |
| 1        | 0              | Europe 1                         |  |                       |       |                    |   |   |       |   |   |        |   |   |          |   |   |          |       |
| 1        | 1              | Europe 2                         |  |                       |       |                    |   |   |       |   |   |        |   |   |          |   |   |          |       |

| Pin No. | Symbol                     | Pin Name                       | Description   | I/O Form |
|---------|----------------------------|--------------------------------|---|----------|
| 55      | Japan Wide/<br>100 k/200 k | FM setting input               | <p>This pin inputs an FM receive frequency band and setting of a channel space. The setting differs depending on the destination region. The setting is read only on application of V<sub>DD</sub> (power-ON reset) or when the CE pin (pin 50) goes high (CE reset); otherwise, it is ignored.</p> <p><b>(1) When the destination region is Japan (Japan Wide)</b><br/>Sets an FM receive frequency band.<br/>Input as follows:</p> <ul style="list-style-type: none"> <li>• High-level input: 76.0 to 108.0 MHz</li> <li>• Low-level input: 76.0 to 90.0 MHz</li> </ul> <p><b>(2) When the destination region is the U.S.A. (100 k/200 k)</b><br/>Sets the channel space of the FM band.<br/>Input as follows:</p> <ul style="list-style-type: none"> <li>• High-level input: 100-kHz step</li> <li>• Low-level input: 200-kHz step</li> </ul> <p><b>(3) When the destination region is China (100 k/200 k)</b><br/>Sets the channel space of the FM band.<br/>Input as follows:</p> <ul style="list-style-type: none"> <li>• High-level input: 50-kHz step</li> <li>• Low-level input: 100-kHz step</li> </ul> | Input    |
| 56      | CLKENA                     | Watch function selection input | <p>This pin inputs the setting for whether the watch function is used or not. The setting is read only on application of V<sub>DD</sub> (power-ON reset) or when the CE pin (pin 50) goes high (CE reset); otherwise, it is ignored. Input as follows:</p> <ul style="list-style-type: none"> <li>• High-level input: Watch function used.</li> <li>• Low-level input: Watch function not used.</li> </ul>  | Input    |

**2. CONFIGURATION OF KEY MATRIX**

**2.1 Layout of Initialization Diode Key Matrix**

| Input Pin<br>(Pin No.)<br>Output Pin<br>(Pin No.) | K0 (10) | K1 (11)    | K2 (12) | K3 (13) |
|---|---------|------------|---------|---------|
| KS1 (4)   | —       | CHINA_BAND | TV_ENA  | STOPSEL |
| KS2 (5)   | SD_IF   | MEMSEL     | IFSEL1  | IFSEL2  |



**Remark** —: Not set

**2.2 Layout of Momentary Key Matrix**

| Input Pin<br>(Pin No.)<br>Output Pin<br>(Pin No.) | K0 (10)           | K1 (11)      | K2 (12) | K3 (13) |
|---|-------------------|--------------|---------|---------|
| KS3 (6)   | SLEEP             | CHECK        | STOP    | BAND    |
| KS4 (7)   | AUTO STORE        | M4           | M5      | +5      |
| KS5 (8)   | MEMORY/AUTO STORE | M1/MEMORY UP | M2      | M3      |
| KS6 (9)   | MODE              | UP           | DOWN    | ALARM   |

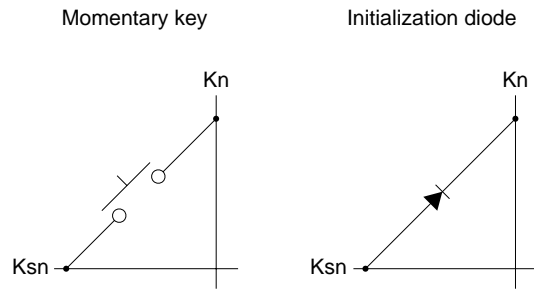
2.3 Connection of Key Matrix



-  Momentary key
-  Initialization diode

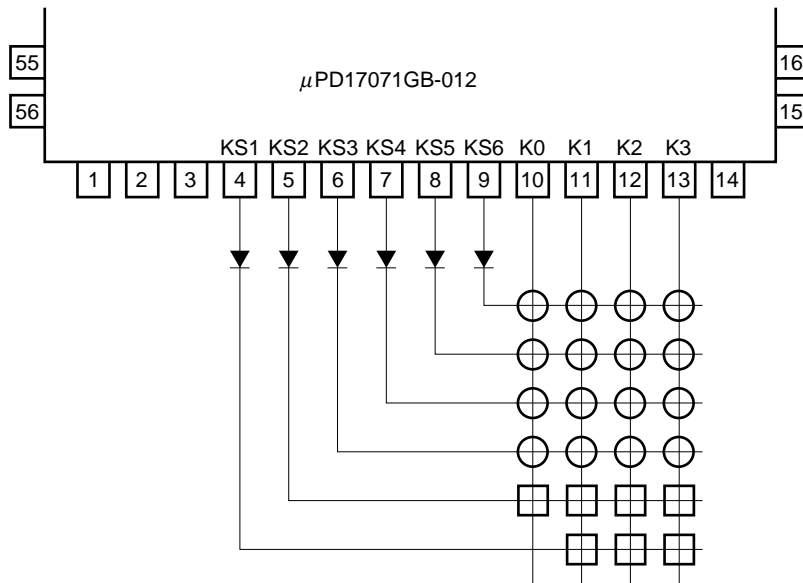



## 2.4 Description of Key Matrix

### 2.4.1 Initialization diode matrix

The initialization diode matrix determines the function of the  $\mu$ PD17071GB-012. Be sure to set this diode matrix.

The setting of the diode matrix is read only on application of  $V_{DD}$  (power-ON reset), or when the CE pin (pin 50) goes high (CE reset); otherwise, it is ignored.

- (1) Switch setting destination region  
CHINA\_BAND
- (2) Switch setting receivable band (valid only when the destination region is Japan)  
TV\_ENA
- (3) Switches setting intermediate frequency of AM band  
IFSEL1, IFSEL2
- (4) Switch setting station detection identification method  
SD\_IF
- (5) Switch setting momentary key for preset memory manipulation  
MEMSEL
- (6) Switch setting momentary key for alarm sound canceling operation  
STOPSEL

To set these switches, short-circuit (1) or open (0) the corresponding switches on the matrix with a diode. The function of the initialization diode matrix is explained next (in alphabetical order).

| Initialization Diode | Function Description   |  |  |                                   |   |   |   |   |                      |  |   |   |           |   |   |  |
|----------------------|--|--|--|-----------------------------------|---|---|---|---|----------------------|--|---|---|-----------|---|---|--|
| CHINA_BAND           | <p>This switch selects the destination region of the application set.<br/>Set this switch as follows:</p> <table border="1"> <thead> <tr> <th>CHINA_BAND</th> <th>Destination region</th> </tr> </thead> <tbody> <tr> <td>0</td> <td>Set by AREA0 and AREA1 pins</td> </tr> <tr> <td>1</td> <td>China</td> </tr> </tbody> </table> <p>(0: Open, 1: Short)<br/>If China is selected as the region by this switch, the setting of AREA0 (pin 53) and AREA1 (pin 54) is invalid.</p>  | CHINA_BAND   | Destination region                     | 0                                 | Set by AREA0 and AREA1 pins               | 1   | China   |   |                      |  |   |   |           |   |   |  |
| CHINA_BAND           | Destination region   |  |  |                                   |   |   |   |   |                      |  |   |   |           |   |   |  |
| 0                    | Set by AREA0 and AREA1 pins  |  |  |                                   |   |   |   |   |                      |  |   |   |           |   |   |  |
| 1                    | China  |  |  |                                   |   |   |   |   |                      |  |   |   |           |   |   |  |
| IFSEL1<br>IFSEL2     | <p>This switch sets an intermediate frequency in the AM band.<br/>Set it as follows:</p> <table border="1"> <thead> <tr> <th>IFSEL1</th> <th>IFSEL2</th> <th>Intermediate Frequency of AM Band</th> </tr> </thead> <tbody> <tr> <td>0</td> <td>0</td> <td>450 kHz</td> </tr> <tr> <td>1</td> <td>0</td> <td>459 kHz/460 kHz</td> </tr> <tr> <td>0</td> <td>1</td> <td>10.71 MHz</td> </tr> <tr> <td>1</td> <td>1</td> <td>Invalid setting.<br/>The intermediate frequency is 450 kHz.</td> </tr> </tbody> </table> <p>(0: Open, 1: Short)<br/>When inputting an intermediate frequency to the FMIFC/AMIFC pin (pin 17) when the intermediate frequency is set to "10.71 kHz", convert the frequency to 450 kHz before inputting.</p> | IFSEL1   | IFSEL2                                 | Intermediate Frequency of AM Band | 0   | 0   | 450 kHz   | 1 | 0                    | 459 kHz/460 kHz  | 0 | 1 | 10.71 MHz | 1 | 1 | Invalid setting.<br>The intermediate frequency is 450 kHz. |
| IFSEL1               | IFSEL2   | Intermediate Frequency of AM Band                                |  |                                   |   |   |   |   |                      |  |   |   |           |   |   |  |
| 0                    | 0  | 450 kHz  |  |                                   |   |   |   |   |                      |  |   |   |           |   |   |  |
| 1                    | 0  | 459 kHz/460 kHz  |  |                                   |   |   |   |   |                      |  |   |   |           |   |   |  |
| 0                    | 1  | 10.71 MHz  |  |                                   |   |   |   |   |                      |  |   |   |           |   |   |  |
| 1                    | 1  | Invalid setting.<br>The intermediate frequency is 450 kHz.       |  |                                   |   |   |   |   |                      |  |   |   |           |   |   |  |
| MEMSEL               | <p>This switch sets the momentary key for preset memory manipulation.<br/>Set it as follows:</p> <table border="1"> <thead> <tr> <th>MEMSEL</th> <th>Preset memory selection operation</th> <th>Auto store memory operation</th> </tr> </thead> <tbody> <tr> <td>0</td> <td><b>M1</b> to <b>M5</b> key<br/><b>+5</b> key</td> <td><b>AUTO STORE</b> key</td> </tr> <tr> <td>1</td> <td><b>MEMORY UP</b> key</td> <td><b>MEMORY</b> key (hold down for 2 seconds or longer)</td> </tr> </tbody> </table> <p>(0: Open, 1: Short)</p>   | MEMSEL   | Preset memory selection operation      | Auto store memory operation       | 0   | <b>M1</b> to <b>M5</b> key<br><b>+5</b> key | <b>AUTO STORE</b> key   | 1 | <b>MEMORY UP</b> key | <b>MEMORY</b> key (hold down for 2 seconds or longer)            |   |   |           |   |   |  |
| MEMSEL               | Preset memory selection operation  | Auto store memory operation                                      |  |                                   |   |   |   |   |                      |  |   |   |           |   |   |  |
| 0                    | <b>M1</b> to <b>M5</b> key<br><b>+5</b> key  | <b>AUTO STORE</b> key  |  |                                   |   |   |   |   |                      |  |   |   |           |   |   |  |
| 1                    | <b>MEMORY UP</b> key   | <b>MEMORY</b> key (hold down for 2 seconds or longer)            |  |                                   |   |   |   |   |                      |  |   |   |           |   |   |  |
| SD_IF                | <p>This switch selects the method for detecting a station.<br/>Set it as follows:</p> <table border="1"> <thead> <tr> <th>SD_IF</th> <th>Station detection method</th> </tr> </thead> <tbody> <tr> <td>0</td> <td>Station detection using frequency counter</td> </tr> <tr> <td>1</td> <td>Station detection using frequency counter and SD signal</td> </tr> </tbody> </table> <p>(0: Open, 1: Short)</p>   | SD_IF  | Station detection method               | 0                                 | Station detection using frequency counter | 1   | Station detection using frequency counter and SD signal         |   |                      |  |   |   |           |   |   |  |
| SD_IF                | Station detection method   |  |  |                                   |   |   |   |   |                      |  |   |   |           |   |   |  |
| 0                    | Station detection using frequency counter  |  |  |                                   |   |   |   |   |                      |  |   |   |           |   |   |  |
| 1                    | Station detection using frequency counter and SD signal  |  |  |                                   |   |   |   |   |                      |  |   |   |           |   |   |  |
| STOPSEL              | <p>This switch sets a momentary key used to cancel alarm sound output.<br/>It is also used to lock or unlock a key.<br/>Set it as follows:</p> <table border="1"> <thead> <tr> <th>STOPSEL</th> <th>Alarm sound output canceling operation</th> <th>Key locking/unlocking</th> </tr> </thead> <tbody> <tr> <td>0</td> <td><b>STOP</b> key</td> <td><b>STOP</b> key and <b>MODE</b> key<br/>(pressed simultaneously)</td> </tr> <tr> <td>1</td> <td><b>ALARM</b> key</td> <td><b>ALARM</b> key and <b>MODE</b> key<br/>(pressed simultaneously)</td> </tr> </tbody> </table> <p>(0: Open, 1: Short)</p>   | STOPSEL  | Alarm sound output canceling operation | Key locking/unlocking             | 0   | <b>STOP</b> key                             | <b>STOP</b> key and <b>MODE</b> key<br>(pressed simultaneously) | 1 | <b>ALARM</b> key     | <b>ALARM</b> key and <b>MODE</b> key<br>(pressed simultaneously) |   |   |           |   |   |  |
| STOPSEL              | Alarm sound output canceling operation   | Key locking/unlocking  |  |                                   |   |   |   |   |                      |  |   |   |           |   |   |  |
| 0                    | <b>STOP</b> key  | <b>STOP</b> key and <b>MODE</b> key<br>(pressed simultaneously)  |  |                                   |   |   |   |   |                      |  |   |   |           |   |   |  |
| 1                    | <b>ALARM</b> key   | <b>ALARM</b> key and <b>MODE</b> key<br>(pressed simultaneously) |  |                                   |   |   |   |   |                      |  |   |   |           |   |   |  |

| Initialization Diode | Function Description   |        |  |   |       |   |          |
|----------------------|--|--------|--|---|-------|---|----------|
| TV_ENA               | <p>This switch is used to select whether a TV band is received.<br/>                     Setting of this switch is valid only when Japan is selected as the destination region.<br/>                     Set it as follows:</p> <table border="1" data-bbox="483 306 1438 436"> <thead> <tr> <th data-bbox="483 306 675 350">TV_ENA</th> <th data-bbox="675 306 1438 350">Receivable band when Japan is selected as region</th> </tr> </thead> <tbody> <tr> <td data-bbox="483 350 675 394">0</td> <td data-bbox="675 350 1438 394">FM/AM</td> </tr> <tr> <td data-bbox="483 394 675 436">1</td> <td data-bbox="675 394 1438 436">FM/AM/TV</td> </tr> </tbody> </table> <p>(0: Open, 1: Short)</p> | TV_ENA | Receivable band when Japan is selected as region | 0 | FM/AM | 1 | FM/AM/TV |
| TV_ENA               | Receivable band when Japan is selected as region   |        |  |   |       |   |          |
| 0                    | FM/AM  |        |  |   |       |   |          |
| 1                    | FM/AM/TV   |        |  |   |       |   |          |

### 2.4.2 Momentary key

Two momentary keys can be pressed simultaneously only in the following combination.

- **STOP** and **MODE** keys to lock or unlock keys
- **ALARM** and **MODE** keys to lock or unlock keys
- **UP** and **DOWN** keys during seek up/down

Any other combinations of keys is invalid when pressed simultaneously.

The chattering wait time is 48 to 64 ms.

The functions of the momentary keys are explained below (in alphabetical order).

| Momentary Key  | Function Description  |     |                      |  |  |  |   |   |                                    |   |  |  |  |
|--|---|-----|----------------------|--|--|--|---|---|------------------------------------|---|--|--|--|
| <p style="text-align: center;"><b>ALARM</b></p>      | <p>This key sets or cancels the alarm and cancels alarm sound output.<br/>                     This key is valid when the watch function is used (when a high level is input to the CLKENA pin (pin 56)).</p> <ul style="list-style-type: none"> <li>• <b>When initialization diode switch STOPSEL = 0</b><br/>                             For setting or canceling alarm</li> <li>• <b>When initialization diode switch STOPSEL = 1</b><br/>                             For setting or canceling alarm and canceling alarm sound output</li> </ul> <p><b>(1) Setting/canceling alarm</b><br/>                     By pressing the <b>ALARM</b> key, the alarm is set at specified time.<br/>                     When the <b>ALARM</b> key is pressed again with the alarm set, the alarm is canceled.<br/>                     While the time is being adjusted and while the alarm time is being set, however, the alarm cannot be set or canceled.<br/>                     For an explanation of how to set the alarm time, refer to the description on the <b>MODE</b> key.</p> <p><b>(2) Canceling alarm sound output (when STOPSEL = 1)</b><br/>                     By pressing the <b>ALARM</b> key when the alarm sound is being output, the output of the alarm can be stopped.</p> <p><b>(3) Locking momentary key (when STOPSEL = 1)</b><br/>                     The momentary key is locked when the <b>MODE</b> key is pressed while the <b>ALARM</b> key is held down.<br/>                     For key locking, refer to the description on the <b>MODE</b> key.</p>   |     |                      |  |  |  |   |   |                                    |   |  |  |  |
| <p style="text-align: center;"><b>AUTO STORE</b></p> | <p>This is a key for auto store memory.<br/>                     It is valid when the radio is ON and the initialization diode switch MEMSEL = 0.</p> <ul style="list-style-type: none"> <li>• <b>Auto store memory</b><br/>                             The auto store memory operation is started when the <b>AUTO STORE</b> key is pressed.<br/>                             This operation automatically searches a station and writes it to the preset memory.<br/>                             During the auto store memory operation, the frequency being sought is displayed.<br/>                             Searching is started from the lowest frequency in a band, and is completed when the highest frequency is found.<br/>                             When stations are found they are stored started from preset M1. When stations have been stored up to M10, the auto store memory operation is completed. If the highest frequency is found before a station is written to M10, the auto store memory operation is stopped at that point. The operation of each key during auto store memory operation is as follows:</li> </ul> <table border="1" data-bbox="500 1266 1437 1686"> <thead> <tr> <th data-bbox="505 1272 691 1308">Key</th> <th data-bbox="691 1272 1432 1308">Function Description</th> </tr> </thead> <tbody> <tr> <td data-bbox="505 1308 691 1514"> <p style="text-align: center;"><b>AUTO STORE</b></p> </td> <td data-bbox="691 1308 1432 1514">                     Stops auto store memory operation.                     <ul style="list-style-type: none"> <li>• If station is written to preset memory as result of auto store memory operation, preset M1 is received.</li> <li>• If no station is written to preset memory as result of auto store memory operation, frequency or preset station, when auto store memory operation is started, is received.</li> </ul> </td> </tr> <tr> <td data-bbox="505 1514 691 1560"> <p style="text-align: center;"><b>BAND</b></p> </td> <td data-bbox="691 1514 1432 1560">                     Stops auto store memory operation and changes band.                 </td> </tr> <tr> <td data-bbox="505 1560 691 1606"> <p style="text-align: center;"><b>ALARM</b></p> </td> <td data-bbox="691 1560 1432 1606">                     Performs operation of pressed key.                 </td> </tr> <tr> <td data-bbox="505 1606 691 1652"> <p style="text-align: center;"><b>CHECK</b></p> </td> <td data-bbox="691 1606 1432 1652">                     Auto store memory operation continues.                 </td> </tr> <tr> <td data-bbox="505 1652 691 1686"> <p style="text-align: center;"><b>STOP</b></p> </td> <td data-bbox="691 1652 1432 1686"></td> </tr> </tbody> </table> <p>Any key other than above is invalid.</p> | Key | Function Description | <p style="text-align: center;"><b>AUTO STORE</b></p> | Stops auto store memory operation. <ul style="list-style-type: none"> <li>• If station is written to preset memory as result of auto store memory operation, preset M1 is received.</li> <li>• If no station is written to preset memory as result of auto store memory operation, frequency or preset station, when auto store memory operation is started, is received.</li> </ul> | <p style="text-align: center;"><b>BAND</b></p> | Stops auto store memory operation and changes band. | <p style="text-align: center;"><b>ALARM</b></p> | Performs operation of pressed key. | <p style="text-align: center;"><b>CHECK</b></p> | Auto store memory operation continues. | <p style="text-align: center;"><b>STOP</b></p> |  |
| Key  | Function Description  |     |                      |  |  |  |   |   |                                    |   |  |  |  |
| <p style="text-align: center;"><b>AUTO STORE</b></p> | Stops auto store memory operation. <ul style="list-style-type: none"> <li>• If station is written to preset memory as result of auto store memory operation, preset M1 is received.</li> <li>• If no station is written to preset memory as result of auto store memory operation, frequency or preset station, when auto store memory operation is started, is received.</li> </ul>  |     |                      |  |  |  |   |   |                                    |   |  |  |  |
| <p style="text-align: center;"><b>BAND</b></p>       | Stops auto store memory operation and changes band.   |     |                      |  |  |  |   |   |                                    |   |  |  |  |
| <p style="text-align: center;"><b>ALARM</b></p>      | Performs operation of pressed key.  |     |                      |  |  |  |   |   |                                    |   |  |  |  |
| <p style="text-align: center;"><b>CHECK</b></p>      | Auto store memory operation continues.  |     |                      |  |  |  |   |   |                                    |   |  |  |  |
| <p style="text-align: center;"><b>STOP</b></p>       |   |     |                      |  |  |  |   |   |                                    |   |  |  |  |

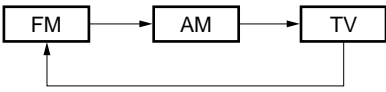
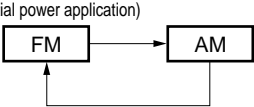
| Momentary Key                       | Function Description  |                                     |           |                     |                     |                     |                   |
|-------------------------------------|---|-------------------------------------|-----------|---------------------|---------------------|---------------------|-------------------|
| <p><b>BAND</b></p>                  | <p>This key is used to select a band.<br/>It is valid when the radio is ON.<br/>Each time the <b>BAND</b> key has been pressed, the band is changed as follows:</p> <ul style="list-style-type: none"> <li>• <b>If Japan is selected as destination region and if initialization diode switch TV_ENA = 1</b></li> </ul> <div style="text-align: center;"> <p>(On initial power application)</p>  <pre> graph LR     FM[FM] --&gt; AM[AM]     AM --&gt; TV[TV]     TV --&gt; FM             </pre> </div> <ul style="list-style-type: none"> <li>• <b>Other than above</b></li> </ul> <div style="text-align: center;"> <p>(On initial power application)</p>  <pre> graph LR     FM[FM] --&gt; AM[AM]     AM --&gt; FM             </pre> </div>   |                                     |           |                     |                     |                     |                   |
| <p><b>CHECK</b></p>                 | <p>This key is used to test lighting of the LCD before shipment.<br/>By pressing the <b>CHECK</b> key, all the segments of the LCD lights for 20 seconds.<br/>If the <b>CHECK</b> key is pressed again while the LCD is lit, the test is stopped.<br/>Any key other than the <b>CHECK</b> key is invalid during the testing of LCD lighting.</p>  |                                     |           |                     |                     |                     |                   |
| <p><b>M1</b> – <b>M5</b></p>        | <p>These keys are used to call a preset station and to write data to the preset memories.<br/>They are valid when the radio is ON and initialization diode switch MEMSEL = 0.</p> <p><b>(1) Calling preset memory</b><br/>By pressing any of the <b>M1</b> through <b>M5</b> keys, the corresponding preset station can be called.<br/>A preset memory number is indicated for 0.5 second, and the corresponding frequency is selected.<br/>Ten preset memories, M1 through M10, each corresponding to a preset station, are available.<br/>To call preset memories M6 through M10, or to write data to these preset memories, refer to the description of the <b>+5</b> Key.</p> <p><b>(2) Writing preset memory</b><br/>The contents of a specified preset memory are written when one of the keys <b>M1</b> to <b>M5</b> is pressed in combination with the <b>MEMORY</b> key.<br/>For how to write data to the preset memory, refer to the description of the <b>MEMORY</b> key.</p> <p>When initialization diode switch MEMSEL = 1, the <b>M1</b> key functions as the <b>MEMORY UP</b> Key.</p> |                                     |           |                     |                     |                     |                   |
| <p><b>MEMORY</b></p>                | <p>This key is for writing data to the preset memory and for auto store memory.<br/>It is valid when the radio is ON.</p> <ul style="list-style-type: none"> <li>• <b>When initialization diode switch MEMSEL = 0</b><br/>For writing preset memory</li> <li>• <b>When initialization diode switch MEMSEL = 1</b><br/>For writing preset memory and auto store memory</li> </ul> <p>The operation is as follows when initialization diode switch MEMSEL = 1.</p> <table border="1" data-bbox="420 1717 1343 1845"> <thead> <tr> <th><b>MEMORY</b> key is held down for:</th> <th>Operation</th> </tr> </thead> <tbody> <tr> <td>Less than 2 seconds</td> <td>Preset memory write</td> </tr> <tr> <td>2 seconds or longer</td> <td>Auto store memory</td> </tr> </tbody> </table>  | <b>MEMORY</b> key is held down for: | Operation | Less than 2 seconds | Preset memory write | 2 seconds or longer | Auto store memory |
| <b>MEMORY</b> key is held down for: | Operation   |                                     |           |                     |                     |                     |                   |
| Less than 2 seconds                 | Preset memory write   |                                     |           |                     |                     |                     |                   |
| 2 seconds or longer                 | Auto store memory   |                                     |           |                     |                     |                     |                   |

| Momentary Key                                    | Function Description  |
|--|---|
| <p style="text-align: center;"><b>MEMORY</b></p> | <p><b>(1) Preset memory writing</b></p> <p>By pressing the <b>MEMORY</b> key, the preset memory is enabled to be written for 10 seconds. Write data to the preset memory in the following sequence:</p> <ul style="list-style-type: none"> <li>• <b>When initialization diode switch MEMSEL = 0</b></li> </ul> <div style="border: 1px dashed black; padding: 5px; margin-bottom: 10px;"> <p>Select the frequency to be stored to the memory by using the <b>UP</b> and <b>DOWN</b> keys.</p> </div> <p style="text-align: center;">↓</p> <div style="border: 1px dashed black; padding: 5px; margin-bottom: 10px;"> <p>Press the <b>MEMORY</b> key to enable the preset memory to be written.</p> </div> <p style="text-align: center;">↓</p> <div style="border: 1px dashed black; padding: 5px;"> <p>Press any of the <b>M1</b> through <b>M5</b> keys in accordance with the preset memory to which data is to be written, and write data to the preset memory.</p> </div><br><ul style="list-style-type: none"> <li>• <b>When initialization diode switch MEMSEL = 1</b></li> </ul> <div style="border: 1px dashed black; padding: 5px; margin-bottom: 10px;"> <p>Select the frequency to be stored in the memory by using the <b>UP</b> and <b>DOWN</b> key.</p> </div> <p style="text-align: center;">↓</p> <div style="border: 1px dashed black; padding: 5px; margin-bottom: 10px;"> <p>Enable the preset memory to be written by pressing the <b>MEMORY</b> key.<br/>The preset memory holding the station received last plus one is automatically selected as the preset memory to be written.</p> </div> <div style="display: flex; justify-content: space-between;"> <div style="width: 45%; text-align: center;"> <p style="text-align: center;">↓</p> <div style="border: 1px dashed black; padding: 5px; margin-bottom: 10px;"> <p>Select the preset memory to be written, by using the <b>MEMORY UP</b> key.</p> </div> <p style="text-align: center;">↓</p> </div> <div style="width: 45%; text-align: center;"> <p style="text-align: center;">↓</p> </div> </div> <div style="border: 1px dashed black; padding: 5px;"> <p style="text-align: center;">Press the <b>MEMORY</b> key again to write data to the preset memory.</p> </div> |

| Momentary Key   | Function Description   |     |                      |                              |  |                         |  |                      |   |  |  |   |   |
|---|--|-----|----------------------|------------------------------|--|-------------------------|--|----------------------|---|--|--|---|---|
| <p><b>MEMORY</b></p>  | <p>The operation of each key is as follows depending on the write status of the preset memory.</p> <table border="1" data-bbox="407 264 1357 1165"> <thead> <tr> <th data-bbox="407 264 662 304">Key</th> <th data-bbox="665 264 1357 304">Function description</th> </tr> </thead> <tbody> <tr> <td data-bbox="407 308 662 478"> <p><b>M1</b> – <b>M5</b></p> </td> <td data-bbox="665 308 1357 478"> <ul style="list-style-type: none"> <li>When initialization diode switch MEMSEL = 0<br/>Data is written to a preset memory and the preset memory write status is released.</li> <li>When initialization diode switch MEMSEL = 1<br/>This key is invalid.</li> </ul> </td> </tr> <tr> <td data-bbox="407 483 662 653"> <p><b>MEMORY UP</b></p> </td> <td data-bbox="665 483 1357 653"> <ul style="list-style-type: none"> <li>When initialization diode switch MEMSEL = 0<br/>This key is invalid.</li> <li>When initialization diode switch MEMSEL = 1<br/>Increments the preset memory to be written by one station. Preset memory M1 is selected next if preset memory M10 is selected.</li> </ul> </td> </tr> <tr> <td data-bbox="407 657 662 827"> <p><b>MEMORY</b></p> </td> <td data-bbox="665 657 1357 827"> <ul style="list-style-type: none"> <li>When initialization diode switch MEMSEL = 0<br/>Releases the preset memory write status.</li> <li>When initialization diode switch MEMSEL = 1<br/>Writes data to a preset memory and releases the preset memory write status.</li> </ul> </td> </tr> <tr> <td data-bbox="407 831 662 940"> <p><b>AUTO STORE</b><br/><b>BAND</b><br/><b>UP</b> / <b>DOWN</b></p> </td> <td data-bbox="665 831 1357 940"> <p>Releases the preset memory write status, and performs the operation of the key pressed.</p> </td> </tr> <tr> <td data-bbox="407 945 662 1165"> <p><b>ALARM</b><br/><b>CHECK</b><br/><b>MODE</b><br/><b>+5</b><br/><b>STOP</b><br/><b>SLEEP</b></p> </td> <td data-bbox="665 945 1357 1165"> <p>Performs the operation of the key pressed.<br/>The preset memory write status continues.</p> </td> </tr> </tbody> </table> <p><b>(2) Auto store memory (when MEMSEL = 1)</b></p> <p>The auto store memory operation is started by holding down the <b>MEMORY</b> key for 2 seconds or longer.</p> <p>During auto store memory operation, this key operates as the <b>AUTO STORE</b> key.</p> <p>For the auto store memory operation, refer to the description on the <b>AUTO STORE</b> key.</p> | Key | Function description | <p><b>M1</b> – <b>M5</b></p> | <ul style="list-style-type: none"> <li>When initialization diode switch MEMSEL = 0<br/>Data is written to a preset memory and the preset memory write status is released.</li> <li>When initialization diode switch MEMSEL = 1<br/>This key is invalid.</li> </ul> | <p><b>MEMORY UP</b></p> | <ul style="list-style-type: none"> <li>When initialization diode switch MEMSEL = 0<br/>This key is invalid.</li> <li>When initialization diode switch MEMSEL = 1<br/>Increments the preset memory to be written by one station. Preset memory M1 is selected next if preset memory M10 is selected.</li> </ul> | <p><b>MEMORY</b></p> | <ul style="list-style-type: none"> <li>When initialization diode switch MEMSEL = 0<br/>Releases the preset memory write status.</li> <li>When initialization diode switch MEMSEL = 1<br/>Writes data to a preset memory and releases the preset memory write status.</li> </ul> | <p><b>AUTO STORE</b><br/><b>BAND</b><br/><b>UP</b> / <b>DOWN</b></p> | <p>Releases the preset memory write status, and performs the operation of the key pressed.</p> | <p><b>ALARM</b><br/><b>CHECK</b><br/><b>MODE</b><br/><b>+5</b><br/><b>STOP</b><br/><b>SLEEP</b></p> | <p>Performs the operation of the key pressed.<br/>The preset memory write status continues.</p> |
| Key   | Function description   |     |                      |                              |  |                         |  |                      |   |  |  |   |   |
| <p><b>M1</b> – <b>M5</b></p>  | <ul style="list-style-type: none"> <li>When initialization diode switch MEMSEL = 0<br/>Data is written to a preset memory and the preset memory write status is released.</li> <li>When initialization diode switch MEMSEL = 1<br/>This key is invalid.</li> </ul>   |     |                      |                              |  |                         |  |                      |   |  |  |   |   |
| <p><b>MEMORY UP</b></p>   | <ul style="list-style-type: none"> <li>When initialization diode switch MEMSEL = 0<br/>This key is invalid.</li> <li>When initialization diode switch MEMSEL = 1<br/>Increments the preset memory to be written by one station. Preset memory M1 is selected next if preset memory M10 is selected.</li> </ul>   |     |                      |                              |  |                         |  |                      |   |  |  |   |   |
| <p><b>MEMORY</b></p>  | <ul style="list-style-type: none"> <li>When initialization diode switch MEMSEL = 0<br/>Releases the preset memory write status.</li> <li>When initialization diode switch MEMSEL = 1<br/>Writes data to a preset memory and releases the preset memory write status.</li> </ul>  |     |                      |                              |  |                         |  |                      |   |  |  |   |   |
| <p><b>AUTO STORE</b><br/><b>BAND</b><br/><b>UP</b> / <b>DOWN</b></p>                                | <p>Releases the preset memory write status, and performs the operation of the key pressed.</p>   |     |                      |                              |  |                         |  |                      |   |  |  |   |   |
| <p><b>ALARM</b><br/><b>CHECK</b><br/><b>MODE</b><br/><b>+5</b><br/><b>STOP</b><br/><b>SLEEP</b></p> | <p>Performs the operation of the key pressed.<br/>The preset memory write status continues.</p>  |     |                      |                              |  |                         |  |                      |   |  |  |   |   |



| Momentary Key           | Function Description   |
|-------------------------|--|
| <p><b>MEMORY UP</b></p> | <p>This key is used to call and write a preset memory.<br/>It is valid when the radio is ON and initialization diode switch MEMSEL = 1.</p> <p><b>(1) Calling preset memory</b><br/>Each time the <b>MEMORY UP</b> is pressed, the preset station is incremented by one and called up. The preset memory number is displayed for 0.5 second, and the corresponding frequency is received.</p> <ul style="list-style-type: none"> <li>When a preset station is already selected, the preset station is incremented by one and selected.<br/>Example: When preset M3 is already selected, this is incremented by one and M4 is selected.<br/>When preset M10 is the current selection, M1 is selected next.</li> <li>If this key is pressed while no preset station is selected, preset M1 is selected.</li> </ul> <p><b>(2) Writing preset memory</b><br/>Data is written to a specified preset memory when this key is used in combination with the <b>MEMORY</b> key.<br/>For an explanation of how to write data to a preset memory, refer to the description of the <b>MEMORY</b> key. When initialization diode switch MEMSEL = 0, this key functions as the <b>M1</b> key.</p>  |
| <p><b>MODE</b></p>      | <p>This key is used to switch the display and the watch adjust mode.<br/>It is valid when the watch function is used (when a high level is input to the CLKENA pin (pin 56)).</p> <ul style="list-style-type: none"> <li>When radio is ON: For switching display</li> <li>When radio is OFF: For switching watch adjust mode</li> </ul> <p><b>(1) Display switching (when radio is ON)</b><br/>Each time the <b>MODE</b> key is pressed, the frequency display or watch display is alternately selected.</p> <p><b>(2) Watch adjust mode switching (when radio is OFF)</b><br/>Each time the <b>MODE</b> key is pressed, the mode is changed as follows:</p> <div data-bbox="581 1108 1372 1243" data-label="Diagram"> <pre> graph LR     A[Watch display] --&gt; B[Alarm time setting mode]     B --&gt; C[Watch adjust mode]     C --&gt; A     </pre> </div> <p>For an explanation of how to adjust the time, refer to the description of the <b>UP</b> and <b>DOWN</b> keys.</p> <p>The momentary keys are locked by the following key operation:</p> <ul style="list-style-type: none"> <li>When STOPSEL = 0: Press the <b>STOP</b> key and then the <b>MODE</b> key twice.</li> <li>When STOPSEL = 1: Press the <b>ALARM</b> key and then the <b>MODE</b> key twice.</li> </ul> <p>While keys are locked, no key operation other than that to manipulate key locking is valid.<br/>By repeating the key locking operation while the keys are locked, the keys are unlocked.<br/>If the momentary keys are locked by input to the KEYLOCK pin (pin 14), the keys cannot be unlocked by a key operation.</p> |

| Momentary Key  | Function Description   |  |           |                      |                                 |                      |              |
|--|--|--|-----------|----------------------|---------------------------------|----------------------|--------------|
| <p style="text-align: center;"><b>+5</b></p>                 | <p>This key is used to select preset memory M6 to M10 in combination with the <b>M1</b> to <b>M5</b> keys. It is valid when the radio is ON and initialization diode switch MEMSEL = 0.</p> <p>When the <b>+5</b> key is pressed, the preset shift status is set.</p> <p>In this status, operating the <b>M1</b> to <b>M5</b> key manipulates preset memory M6 to M10. The preset shift status is released on completion of the operation. If the <b>+5</b> key is pressed again in the preset shift status, the preset shift status is released.</p>  |  |           |                      |                                 |                      |              |
| <p style="text-align: center;"><b>SLEEP</b></p>              | <p>This key is used to set the sleep timer.</p> <p>It is valid when the radio is ON.</p> <p>When the <b>SLEEP</b> key is pressed, the remaining time of the sleep timer is displayed for 10 seconds. The initial value of the remaining time of the sleep timer is 120 minutes.</p> <p>If the <b>SLEEP</b> key is pressed while the remaining time of the sleep timer is displayed, the time is decremented in steps of 30 minutes.</p> <p>(Example 60 minutes → 30 minutes, 45 minutes → 30 minutes)</p> <p>If the remaining time reaches 0 minutes, the sleep timer is released.</p> <p>If the radio is turned OFF (CE = low level) while the sleep timer is valid, the sleep timer is released.</p>   |  |           |                      |                                 |                      |              |
| <p style="text-align: center;"><b>STOP</b></p>               | <p>This key is used to cancel output of the alarm sound.</p> <p>It is valid when the watch function is used (when a high level is input to the CLKENA pin (pin 56)).</p> <p>It is valid when initialization diode switch STOPSEL = 0.</p> <p><b>(1) Stopping alarm sound output</b></p> <p>By pressing the <b>STOP</b> key while the alarm sound is output, output of the alarm sound can be stopped.</p> <p><b>(2) Locking momentary keys (when STOPSEL = 0)</b></p> <p>Momentary keys can be locked by pressing the <b>STOP</b> key and then the <b>MODE</b> key twice.</p> <p>For an explanation of how to lock the keys, refer to the description of the <b>MODE</b> key.</p>  |  |           |                      |                                 |                      |              |
| <p style="text-align: center;"><b>UP</b><br/><b>DOWN</b></p> | <p>This key is used to increment/decrement the receive frequency and adjust the time.</p> <ul style="list-style-type: none"> <li>• When radio is ON: To increment/decrement receive frequency</li> <li>• When radio is OFF: To adjust time and set alarm time</li> </ul> <p><b>(1) Incrementing/decrementing receive frequency (when radio is ON)</b></p> <table border="1" data-bbox="436 1304 1328 1434"> <thead> <tr> <th data-bbox="441 1310 883 1346">Time to hold down <b>UP</b> or <b>DOWN</b> key</th> <th data-bbox="886 1310 1323 1346">Operation</th> </tr> </thead> <tbody> <tr> <td data-bbox="441 1350 883 1386">Less than 0.5 second</td> <td data-bbox="886 1350 1323 1386">Increments/decrements 1 channel</td> </tr> <tr> <td data-bbox="441 1390 883 1425">0.5 second or longer</td> <td data-bbox="886 1390 1323 1425">Seek up/down</td> </tr> </tbody> </table> | Time to hold down <b>UP</b> or <b>DOWN</b> key | Operation | Less than 0.5 second | Increments/decrements 1 channel | 0.5 second or longer | Seek up/down |
| Time to hold down <b>UP</b> or <b>DOWN</b> key               | Operation  |  |           |                      |                                 |                      |              |
| Less than 0.5 second   | Increments/decrements 1 channel  |  |           |                      |                                 |                      |              |
| 0.5 second or longer   | Seek up/down   |  |           |                      |                                 |                      |              |

| Momentary Key   | Function Description  |                       |  |  |  |  |   |  |   |   |   |     |                      |                       |           |  |              |                      |   |                      |  |  |            |                      |   |                      |   |
|---|---|-----------------------|--|--|--|--|---|--|---|---|---|-----|----------------------|-----------------------|-----------|--|--------------|----------------------|---|----------------------|--|--|------------|----------------------|---|----------------------|---|
| <div style="border: 1px solid black; padding: 2px; width: fit-content; margin-bottom: 5px;">UP</div> <div style="border: 1px solid black; padding: 2px; width: fit-content;">DOWN</div>   | <p>The operation of each key is as follows during seek up/down operation.</p> <table border="1" data-bbox="516 262 1437 861"> <thead> <tr> <th data-bbox="516 262 706 304">Key</th> <th data-bbox="706 262 1437 304">Function description</th> </tr> </thead> <tbody> <tr> <td data-bbox="516 304 706 451"> <div style="border: 1px solid black; padding: 2px; width: fit-content; margin: 0 auto;">UP</div> </td> <td data-bbox="706 304 1437 451"> <ul style="list-style-type: none"> <li>If the key is pressed while the seek up operation is in progress, the seek operation is stopped, and the frequency at which the seek operation was started is received.</li> <li>During the seek down operation, the seek up operation is started.</li> </ul> </td> </tr> <tr> <td data-bbox="516 451 706 588"> <div style="border: 1px solid black; padding: 2px; width: fit-content; margin: 0 auto;">DOWN</div> </td> <td data-bbox="706 451 1437 588"> <ul style="list-style-type: none"> <li>If the key is pressed while the seek down operation is in progress, the seek operation is stopped and the frequency at which the seek operation was started is received.</li> <li>During the seek up operation, the seek down operation is started.</li> </ul> </td> </tr> <tr> <td data-bbox="516 588 706 703"> <div style="border: 1px solid black; padding: 2px; width: fit-content; margin: 0 auto;">BAND</div> <div style="border: 1px solid black; padding: 2px; width: fit-content; margin: 2px auto;">M1 ~ M5</div> <div style="border: 1px solid black; padding: 2px; width: fit-content; margin: 2px auto;">MEMORY UP</div> </td> <td data-bbox="706 588 1437 703">Stops the seek operation and performs the operation of the key pressed.</td> </tr> <tr> <td data-bbox="516 703 706 861"> <div style="border: 1px solid black; padding: 2px; width: fit-content; margin: 0 auto;">ALARM</div> <div style="border: 1px solid black; padding: 2px; width: fit-content; margin: 2px auto;">CHECK</div> <div style="border: 1px solid black; padding: 2px; width: fit-content; margin: 2px auto;">+5</div> <div style="border: 1px solid black; padding: 2px; width: fit-content; margin: 2px auto;">STOP</div> </td> <td data-bbox="706 703 1437 861">                     Performs the operation of the key pressed.<br/>                     The seek operation continues.                 </td> </tr> </tbody> </table> <p>Any key other than above is invalid.</p> <p><b>(2) Adjusting time and setting alarm time (when radio is OFF)</b></p> <p>By pressing the <div style="border: 1px solid black; padding: 2px; width: fit-content;">UP</div> or <div style="border: 1px solid black; padding: 2px; width: fit-content;">DOWN</div> key in the alarm time setting mode or time adjust mode, the time can be adjusted.</p> <p>The following operation is performed in the alarm time setting mode and time adjust mode.</p> <table border="1" data-bbox="516 1066 1437 1543"> <thead> <tr> <th data-bbox="516 1066 641 1144">Key</th> <th data-bbox="641 1066 803 1144">Digit to be adjusted</th> <th data-bbox="803 1066 966 1144">Time to hold down key</th> <th data-bbox="966 1066 1437 1144">Operation</th> </tr> </thead> <tbody> <tr> <td data-bbox="516 1144 641 1354" rowspan="2"> <div style="border: 1px solid black; padding: 2px; width: fit-content; margin: 0 auto;">UP</div> </td> <td data-bbox="641 1144 803 1354" rowspan="2">Minute digit</td> <td data-bbox="803 1144 966 1218">Less than 0.5 second</td> <td data-bbox="966 1144 1437 1218">Increments time by 1 minute each time the key is pressed.</td> </tr> <tr> <td data-bbox="803 1218 966 1354">0.5 second or longer</td> <td data-bbox="966 1218 1437 1354">Fast-forward the time at a rate of 8 minutes/second until the key is released. No carry to the hour digit occurs. Each time the minute digit has been adjusted, the second count value is reset.</td> </tr> <tr> <td data-bbox="516 1354 641 1543" rowspan="2"> <div style="border: 1px solid black; padding: 2px; width: fit-content; margin: 0 auto;">DOWN</div> </td> <td data-bbox="641 1354 803 1543" rowspan="2">Hour digit</td> <td data-bbox="803 1354 966 1428">Less than 0.5 second</td> <td data-bbox="966 1354 1437 1428">Increments time by 1 hour each time the key is pressed.</td> </tr> <tr> <td data-bbox="803 1428 966 1543">0.5 second or longer</td> <td data-bbox="966 1428 1437 1543">Fast-forwards the time at a rate of 4 hours/second until the key is released. The minute digit and second count value are not affected.</td> </tr> </tbody> </table> | Key                   | Function description   | <div style="border: 1px solid black; padding: 2px; width: fit-content; margin: 0 auto;">UP</div> | <ul style="list-style-type: none"> <li>If the key is pressed while the seek up operation is in progress, the seek operation is stopped, and the frequency at which the seek operation was started is received.</li> <li>During the seek down operation, the seek up operation is started.</li> </ul> | <div style="border: 1px solid black; padding: 2px; width: fit-content; margin: 0 auto;">DOWN</div> | <ul style="list-style-type: none"> <li>If the key is pressed while the seek down operation is in progress, the seek operation is stopped and the frequency at which the seek operation was started is received.</li> <li>During the seek up operation, the seek down operation is started.</li> </ul> | <div style="border: 1px solid black; padding: 2px; width: fit-content; margin: 0 auto;">BAND</div> <div style="border: 1px solid black; padding: 2px; width: fit-content; margin: 2px auto;">M1 ~ M5</div> <div style="border: 1px solid black; padding: 2px; width: fit-content; margin: 2px auto;">MEMORY UP</div> | Stops the seek operation and performs the operation of the key pressed. | <div style="border: 1px solid black; padding: 2px; width: fit-content; margin: 0 auto;">ALARM</div> <div style="border: 1px solid black; padding: 2px; width: fit-content; margin: 2px auto;">CHECK</div> <div style="border: 1px solid black; padding: 2px; width: fit-content; margin: 2px auto;">+5</div> <div style="border: 1px solid black; padding: 2px; width: fit-content; margin: 2px auto;">STOP</div> | Performs the operation of the key pressed.<br>The seek operation continues. | Key | Digit to be adjusted | Time to hold down key | Operation | <div style="border: 1px solid black; padding: 2px; width: fit-content; margin: 0 auto;">UP</div> | Minute digit | Less than 0.5 second | Increments time by 1 minute each time the key is pressed. | 0.5 second or longer | Fast-forward the time at a rate of 8 minutes/second until the key is released. No carry to the hour digit occurs. Each time the minute digit has been adjusted, the second count value is reset. | <div style="border: 1px solid black; padding: 2px; width: fit-content; margin: 0 auto;">DOWN</div> | Hour digit | Less than 0.5 second | Increments time by 1 hour each time the key is pressed. | 0.5 second or longer | Fast-forwards the time at a rate of 4 hours/second until the key is released. The minute digit and second count value are not affected. |
| Key   | Function description  |                       |  |  |  |  |   |  |   |   |   |     |                      |                       |           |  |              |                      |   |                      |  |  |            |                      |   |                      |   |
| <div style="border: 1px solid black; padding: 2px; width: fit-content; margin: 0 auto;">UP</div>  | <ul style="list-style-type: none"> <li>If the key is pressed while the seek up operation is in progress, the seek operation is stopped, and the frequency at which the seek operation was started is received.</li> <li>During the seek down operation, the seek up operation is started.</li> </ul>  |                       |  |  |  |  |   |  |   |   |   |     |                      |                       |           |  |              |                      |   |                      |  |  |            |                      |   |                      |   |
| <div style="border: 1px solid black; padding: 2px; width: fit-content; margin: 0 auto;">DOWN</div>  | <ul style="list-style-type: none"> <li>If the key is pressed while the seek down operation is in progress, the seek operation is stopped and the frequency at which the seek operation was started is received.</li> <li>During the seek up operation, the seek down operation is started.</li> </ul>   |                       |  |  |  |  |   |  |   |   |   |     |                      |                       |           |  |              |                      |   |                      |  |  |            |                      |   |                      |   |
| <div style="border: 1px solid black; padding: 2px; width: fit-content; margin: 0 auto;">BAND</div> <div style="border: 1px solid black; padding: 2px; width: fit-content; margin: 2px auto;">M1 ~ M5</div> <div style="border: 1px solid black; padding: 2px; width: fit-content; margin: 2px auto;">MEMORY UP</div>  | Stops the seek operation and performs the operation of the key pressed.   |                       |  |  |  |  |   |  |   |   |   |     |                      |                       |           |  |              |                      |   |                      |  |  |            |                      |   |                      |   |
| <div style="border: 1px solid black; padding: 2px; width: fit-content; margin: 0 auto;">ALARM</div> <div style="border: 1px solid black; padding: 2px; width: fit-content; margin: 2px auto;">CHECK</div> <div style="border: 1px solid black; padding: 2px; width: fit-content; margin: 2px auto;">+5</div> <div style="border: 1px solid black; padding: 2px; width: fit-content; margin: 2px auto;">STOP</div> | Performs the operation of the key pressed.<br>The seek operation continues.   |                       |  |  |  |  |   |  |   |   |   |     |                      |                       |           |  |              |                      |   |                      |  |  |            |                      |   |                      |   |
| Key   | Digit to be adjusted  | Time to hold down key | Operation  |  |  |  |   |  |   |   |   |     |                      |                       |           |  |              |                      |   |                      |  |  |            |                      |   |                      |   |
| <div style="border: 1px solid black; padding: 2px; width: fit-content; margin: 0 auto;">UP</div>  | Minute digit  | Less than 0.5 second  | Increments time by 1 minute each time the key is pressed.  |  |  |  |   |  |   |   |   |     |                      |                       |           |  |              |                      |   |                      |  |  |            |                      |   |                      |   |
|   |   | 0.5 second or longer  | Fast-forward the time at a rate of 8 minutes/second until the key is released. No carry to the hour digit occurs. Each time the minute digit has been adjusted, the second count value is reset. |  |  |  |   |  |   |   |   |     |                      |                       |           |  |              |                      |   |                      |  |  |            |                      |   |                      |   |
| <div style="border: 1px solid black; padding: 2px; width: fit-content; margin: 0 auto;">DOWN</div>  | Hour digit  | Less than 0.5 second  | Increments time by 1 hour each time the key is pressed.  |  |  |  |   |  |   |   |   |     |                      |                       |           |  |              |                      |   |                      |  |  |            |                      |   |                      |   |
|   |   | 0.5 second or longer  | Fast-forwards the time at a rate of 4 hours/second until the key is released. The minute digit and second count value are not affected.  |  |  |  |   |  |   |   |   |     |                      |                       |           |  |              |                      |   |                      |  |  |            |                      |   |                      |   |

## 2.5 Alarm Function

The alarm function outputs an alarm sound at specified alarm time every day.

Only one alarm time can be set.

When the watch function is not selected on initialization, the alarm function cannot be used.

For initialization of the watch function, refer to the description on the CLKENA pin (pin 56).

### (1) Setting of alarm time

To set alarm time, select the alarm time setting mode when the radio is OFF.

Each time the **MODE** key is pressed when the radio is OFF, the mode is changed as follows:

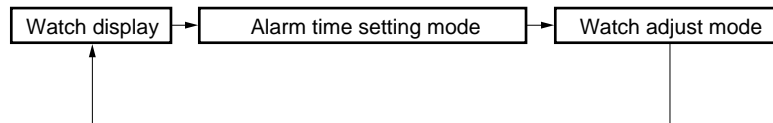

The alarm time can be adjusted by using the **UP** and **DOWN** key in the alarm time setting mode.

The operation is as follows in the alarm time setting mode.

| Key         | Digit to Be Adjusted | Time to Hold Down Key | Operation  |
|-------------|----------------------|-----------------------|--|
| <b>UP</b>   | Minute digit         | Less than 0.5 second  | Increments the minute by one each time the key is pressed.                 |
|             |                      | 0.5 second or longer  | Increments the minute at a rate of 8 minutes/second until key is released. |
| <b>DOWN</b> | Hour digit           | Less than 0.5 second  | Increments the hour by one each time the key is pressed.                   |
|             |                      | 0.5 second or longer  | Increments the hour at a rate of 4 hours/second until the key is released. |

The initial alarm time on power application is “00:00” (midnight).

### (2) Setting/releasing alarm

By pressing the **ALARM** key, the alarm is set for the time set.

When the time has reached the alarm time set, output of the alarm sound is started.

The alarm can be released by pressing the **ALARM** key again while the alarm is set.

However, the alarm cannot be set or released in the time adjust mode or alarm time setting mode.

### (3) Canceling alarm sound output

Output of the alarm sound is stopped if the key for canceling the alarm sound output is pressed while the alarm sound is being output.

The following key is used as the key for canceling the alarm sound output, depending on the initialization.

- When initialization diode switch STOPSEL = 0

**STOP** key

- When initialization diode switch STOPSEL = 1

**ALARM** key

The output of the alarm sound continues for 10 minutes from the start, or until it is canceled.

## 2.6 Key Lock Function

The key lock function is to lock the momentary keys and invalidate key operations.

The keys are locked by input to the KEYLOCK pin (pin 14).

When the input to the KEYLOCK pin is low, the keys can also be locked by a key operation.

### (1) Locking keys by input to KEYLOCK pin (pin 14)

The momentary keys can be locked by input to the KEYLOCK pin.

The operation of the momentary keys can be manipulated as follows by the pin input.

- High-level input  
Locks keys and invalidates all key operations.  
Also invalidates the key operation to unlock the keys.
- Low-level input  
All the keys perform normally when the keys are pressed.  
At this time, the keys can be locked or unlocked by a key operation.

### (2) Locking keys by key operation

The keys can be locked or unlocked by a key operation when the input to the KEYLOCK pin (pin 14) is low. If the input to the KEYLOCK pin is high, however, the locked keys cannot be unlocked by a key operation.

The momentary keys are locked by performing the following key lock operation.

- When the keys are locked, they are unlocked when the key lock operation is performed again.
- When the keys are locked, all key operations other than that to unlock the key is invalid.

The following key lock operation is performed, depending on initialization.

- **When initialization diode switch STOPSEL = 0**  
Press the **STOP** key and then the **MODE** key twice.
- **When initialization diode switch STOPSEL =1**  
Press the **ALARM** key and then the **MODE** key twice.

### 3. LCD DISPLAY

#### 3.1 LCD Panel

The configuration of the LCD panel is shown below.



#### 3.2 Font



#### 3.3 LCD Pattern

##### (1) Connection of segment lines

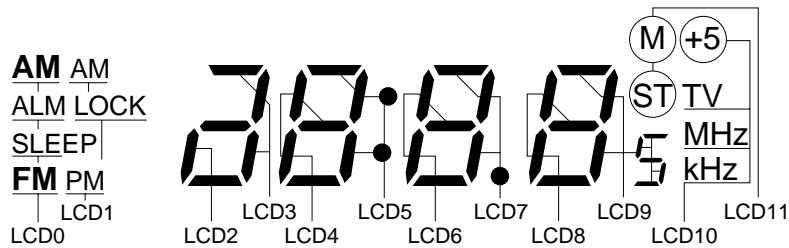

##### (2) Connection of common lines

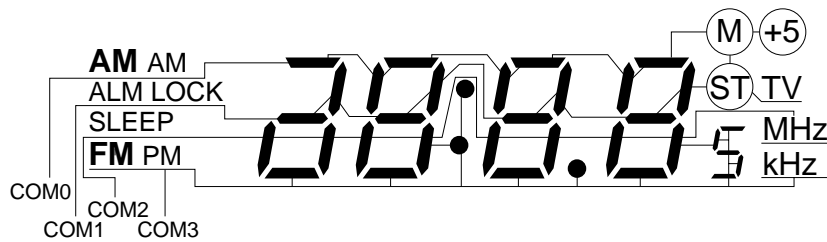

### 3.4 LCD Pin Assignment

Table 3-1 shows assignment of the LCD pins.

<1> through <4> in the figure and table below indicate the column positions of the 7-segment digits. "a" through "f" indicate the segments of each digit.

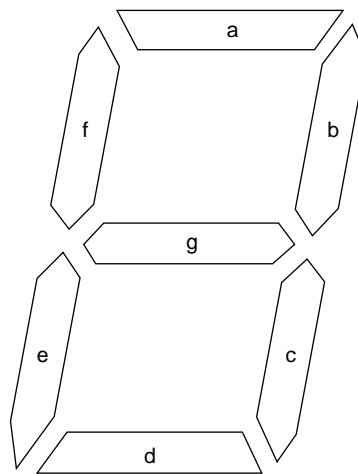
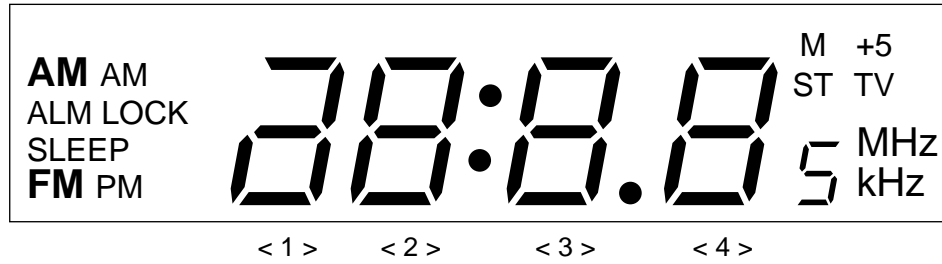



Table 3-1. Assignment of LCD Pins

| Segment \ Common | COM0 (31) | COM1 (32) | COM2 (33) | COM3 (34) |
|------------------|-----------|-----------|-----------|-----------|
| LCD0 (35)        | AM        | ALM       | SLEEP     | FM        |
| LCD1 (36)        | AM        | LOCK      | —         | PM        |
| LCD2 (37)        | —         | <1>g      | <1>e      | <1>d      |
| LCD3 (38)        | <1>a      | <1>b      | <1>c      | —         |
| LCD4 (39)        | <2>f      | <2>g      | <2>e      | <2>d      |
| LCD5 (40)        | <2>a      | <2>b      | <2>c      | :         |
| LCD6 (41)        | <3>f      | <3>g      | <3>e      | <3>d      |
| LCD7 (42)        | <3>a      | <3>b      | <3>c      | .         |
| LCD8 (43)        | <4>f      | <4>g      | <4>e      | <4>d      |
| LCD9 (44)        | <4>a      | <4>b      | <4>c      | 5         |
| LCD10 (45)       | +5        | TV        | MHz       | kHz       |
| LCD11 (46)       | M         | ST        | —         | —         |
| LCD12 (47)       | —         | —         | —         | —         |
| LCD13 (48)       | —         | —         | —         | —         |
| LCD14 (49)       | —         | —         | —         | —         |

**Remarks** 1. Numbers in brackets ( ) are pin numbers.  
 2. —: Not used



### 3.5 Display Description

| Symbol  | Description   |
|---|---|
| <b>AM</b>   | Lights when the AM band is selected in the radio mode.<br>Lights only when a frequency is displayed.  |
| AM  | Lights when the time is in the morning in the 12-hour mode.   |
| ALM   | Lights while the alarm is set.<br>Always lights while alarm time is set, and goes off while time is being adjusted.   |
| <b>FM</b>   | Lights when the FM band is selected in the radio mode.<br>Lights only when a frequency is displayed.  |
| kHz   | Lights when a frequency is displayed or AM band is selected in the radio mode.  |
| LOCK  | Lights when key locking is valid.   |
| M   | Lights when the preset memory is manipulated in the radio mode.<br>Also lights at 1 Hz when the preset memory is enabled to be written.                     |
| MHz   | Lights when a frequency is displayed and the FM band is selected in the radio mode.   |
| +5  | Lights when +5 (preset memory shift) is valid in the radio mode.  |
| PM  | Lights when the time is in the afternoon in the 12-hour mode.   |
| SLEEP   | Lights when the sleep timer is set.   |
| ST  | Lights when the stereo input is low in the radio mode.  |
| TV  | Lights when the TV band is selected in the radio mode.<br>Lights only when a frequency is displayed.  |
| ●   | Lights when time is displayed. However, blinks at 1 Hz in synchronization with time display when the time or alarm time is adjusted.                        |
| ●   |   |
| ●   | Lights when a frequency in the FM band is selected.   |
| 5   | Lights to indicate the least significant digit of a frequency in the FM band (part).<br>Lights if the least significant digit is 5 and goes off if it is 0. |
|  | Displays a frequency, time, and timer.<br>The high-order digits is zero-suppressed.   |

3.6 Display Example

(1) Initial display (without time set, 12-hour display)

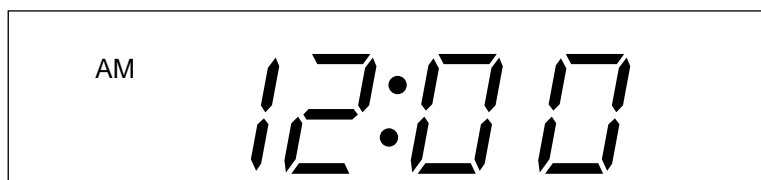

(2) Initial display (without time set, 24-hour display)

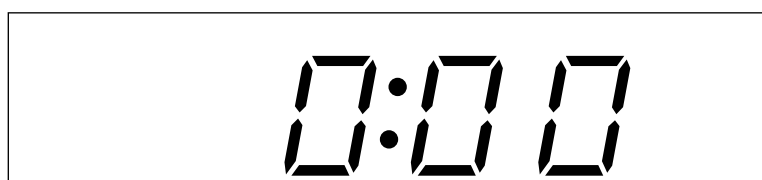

(3) Watch display (during FM band selection)

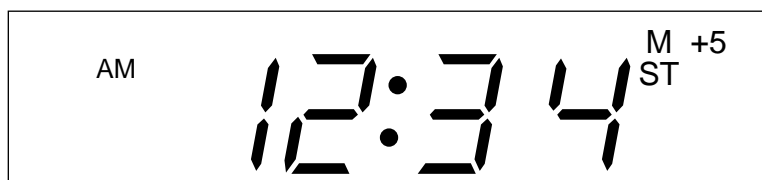

This is an example of display with "M" and "+5" lit while a stereo station is selected at 12:34 a.m.

The "FM" and "AM" indications are not displayed to avoid confusion with time when time is displayed in the radio mode.

(4) Frequency display (during FM band selection)

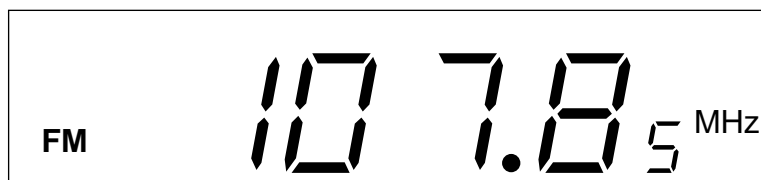

(5) Frequency display (during AM band selection)



(6) Frequency display (during TV band selection)

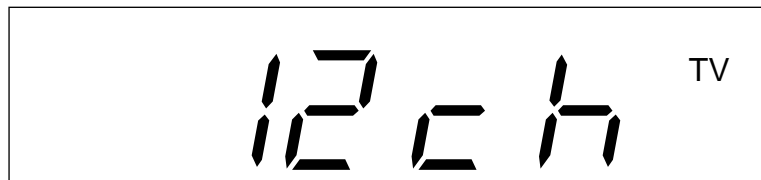

(7) Sleep timer display

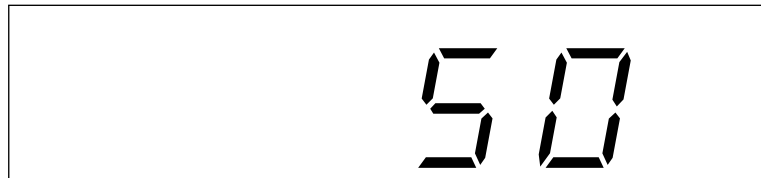

### 4. MUTE OUTPUT TIMING CHART

This section describes the timing of the mute output.

<1> through <7> in the timing charts indicate the time required for the respective processing, as follows:

- <1> Key ON chattering wait time
- <2> Mute leading time
- <3> Division ratio setting and display contents updating time
- <4> Mute trailing time
- <5> Scan time
- <6> PLL lock wait time
- <7> Key OFF chattering wait time

#### 4.1 Manual up/down (operates by pressing key and releasing within 0.5 sec)

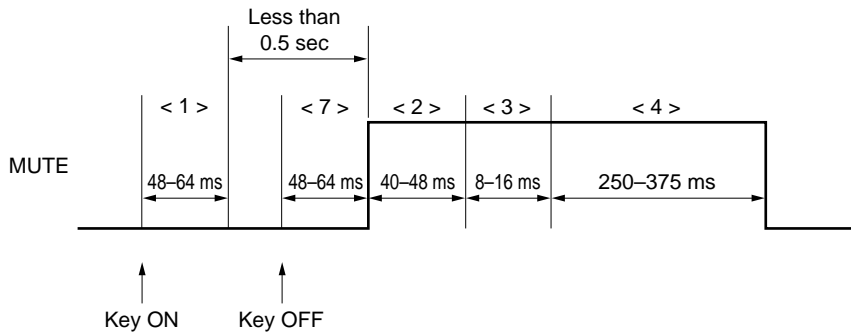

Time of <4> is 625 to 750 ms at the band edge.

#### 4.2 Auto up/down (operates by holding down key for 0.5 sec or longer)

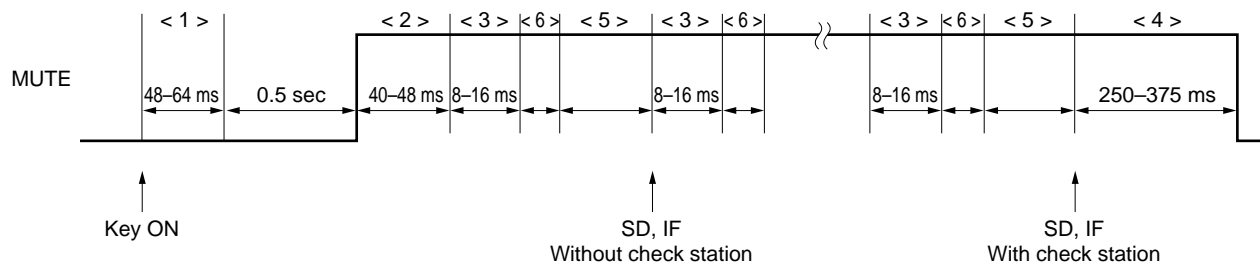

Scan time of <5> is as follows depending the received band.

FM: 40 to 48 ms

AM: 24 to 32 ms

TV: 496 to 504 ms

Time of <5> is 500 ms, and time of <4> is 625 to 750 ms at the band edge.

4.3 Calling Preset Memory

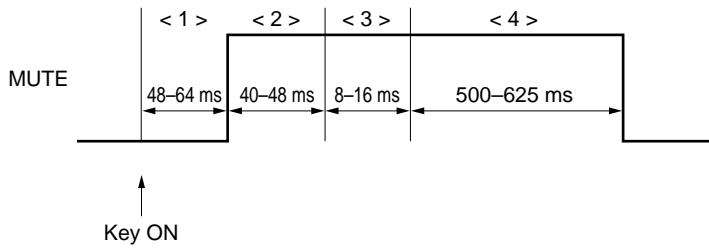

Time of <2> to <4> is the tuner mute time.

4.4 Band Selection

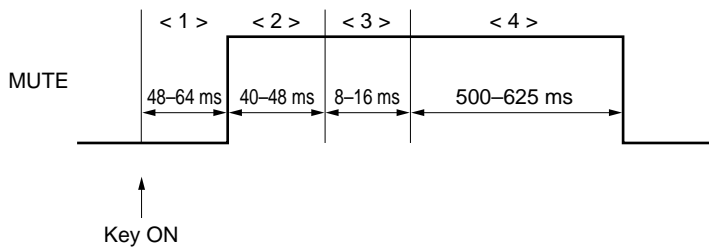

4.5 CE Pin

4.5.1 High level to low level

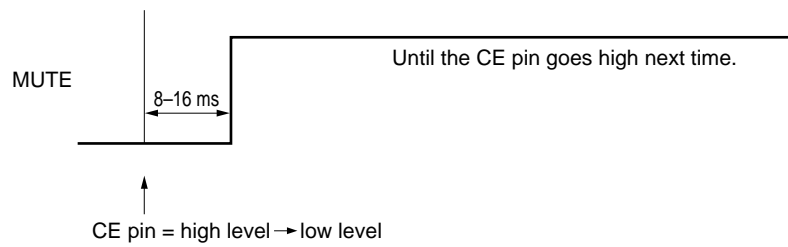

4.5.2 Low level to high level

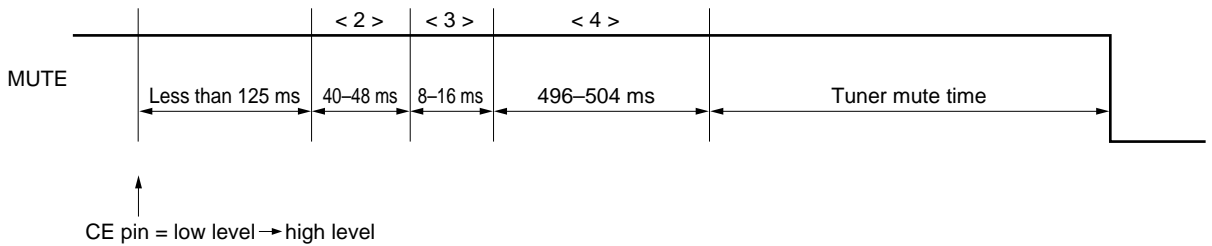

The tuner mute time is the same as 4.3 Calling Preset Memory.

### 4.6 Sleep Timer

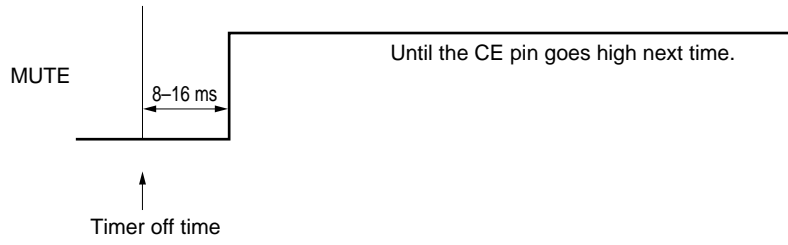

5. ELECTRICAL SPECIFICATIONS (PRELIMINARY)

Absolute Maximum Ratings (T<sub>A</sub> = 25 °C)

| Parameter                 | Symbol           | Condition         | Rating                       | Unit |
|---------------------------|------------------|-------------------|------------------------------|------|
| Supply voltage            | V <sub>DD</sub>  |                   | -0.3 to +4.0                 | V    |
| Input voltage             | V <sub>I</sub>   | CE pin            | -0.3 to V <sub>DD</sub> +0.6 | V    |
|                           |                  | Other than CE pin | -0.3 to V <sub>DD</sub> +0.3 | V    |
| Output voltage            | V <sub>O</sub>   |                   | -0.3 to V <sub>DD</sub> +0.3 | V    |
| High-level output current | I <sub>OH</sub>  | 1 pin             | -3.0                         | mA   |
|                           |                  | Total of all pins | -20.0                        | mA   |
| Low-level output current  | I <sub>OL</sub>  | 1 pin             | 3.0                          | mA   |
|                           |                  | Total of all pins | 20.0                         | mA   |
| Operating temperature     | T <sub>A</sub>   |                   | -20 to +70                   | °C   |
| Storage temperature       | T <sub>stg</sub> |                   | -55 to +125                  | °C   |

**Caution** If any of the parameters exceeds the absolute maximum ratings, even momentarily, the quality of the product may be impaired. The absolute maximum ratings are values that may physically damage the product(s). Be sure to use the product(s) within the ratings.

Recommended Operating Range

| Parameter                    | Symbol            | Condition  | MIN.                           | TYP. | MAX. | Unit |
|------------------------------|-------------------|--|--------------------------------|------|------|------|
| Supply voltage               | V <sub>DD1</sub>  | When CPU, PLL, and AD operates                       | 1.8                            | 3.0  | 3.6  | V    |
|                              |                   | T <sub>A</sub> = -20 to +70 °C                       |                                |      |      |      |
|                              | V <sub>DD2</sub>  | When CPU operates, and PLL and AD stop               | T <sub>A</sub> = -10 to +70 °C | 1.7  | 3.0  | 3.6  |
| T <sub>A</sub> = 0 to +70 °C |                   |  | 1.6                            | 3.0  | 3.6  | V    |
| Supply voltage rise time     | t <sub>RISE</sub> | V <sub>DD</sub> = 0 → 1.8 V (T <sub>A</sub> = 25 °C) |                                |      | 500  | ms   |

DC Characteristics (T<sub>A</sub> = -20 to +70 °C, V<sub>DD</sub> = 1.8 to 3.6 V)

(1/2)

| Parameter                  | Symbol            | Condition   | MIN.                | TYP. | MAX.                 | Unit |
|----------------------------|-------------------|---|---------------------|------|----------------------|------|
| Supply current             | I <sub>DD1</sub>  | When CPU and PLL are operating with sine wave input to VCOH pin<br>(f <sub>IN</sub> = 250 MHz, V <sub>IN</sub> = 0.2 Vp-p)<br>V <sub>DD</sub> = 3 V, T <sub>A</sub> = 25 °C   |                     | 6.5  | 10                   | mA   |
|                            | I <sub>DD2</sub>  | When CPU is operating and PLL is stopped (IF counter stops) with sine wave input to X <sub>IN</sub> pin<br>(f <sub>IN</sub> = 75 kHz, V <sub>IN</sub> = V <sub>DD</sub> )<br>V <sub>DD</sub> = 3 V, T <sub>A</sub> = 25 °C  |                     | 35   | 45                   | μA   |
|                            | I <sub>DD3</sub>  | When CPU and PLL are stopped (when HALT instruction is used) with sine wave input to X <sub>IN</sub> pin<br>(f <sub>IN</sub> = 75 kHz, V <sub>IN</sub> = V <sub>DD</sub> )<br>V <sub>DD</sub> = 3 V, T <sub>A</sub> = 25 °C |                     | 10   | 18                   | μA   |
| Data retention voltage     | V <sub>DDR</sub>  | On detection of power failure   | 1.7                 |      |                      | V    |
| Data retention current     | I <sub>DDR</sub>  | When crystal oscillator stops<br>V <sub>DD</sub> = 3.0 V, T <sub>A</sub> = 25 °C  |                     |      | 3                    | μA   |
| High-level input voltage   | V <sub>IH1</sub>  | CE, INT, P0B0-P0B3, P0C0, P0C1, P0D2, P0D3  | 0.8 V <sub>DD</sub> |      |                      | V    |
|                            | V <sub>IH2</sub>  | P1A0-P1A3   | 0.5 V <sub>DD</sub> |      |                      | V    |
| Low-level input voltage    | V <sub>IL1</sub>  | CE, INT, P0B0-P0B3, P0C0, P0C1, P0D2, P0D3  |                     |      | 0.2 V <sub>DD</sub>  | V    |
|                            | V <sub>IL2</sub>  | P1A0-P1A3   |                     |      | 0.05 V <sub>DD</sub> | V    |
| High-level output current  | I <sub>OH1</sub>  | P0A0-P0A3, P0B0-P0B3, P0C0, P0C1, P0D2, P0D3, P1B0-P1B3, P1C0, BEEP<br>V <sub>OH</sub> = V <sub>DD</sub> - 0.5 V  | -0.5                |      |                      | mA   |
|                            | I <sub>OH2</sub>  | EO<br>V <sub>OH</sub> = V <sub>DD</sub> - 0.5 V   | -0.2                |      |                      | mA   |
|                            | I <sub>OH3</sub>  | LCD0-LCD14<br>V <sub>OH</sub> = V <sub>DD</sub> - 0.5 V   | -20                 |      |                      | μA   |
| Low-level output current   | I <sub>OL1</sub>  | P0A0-P0A3, P0B0-P0B3, P0C0, P0C1, P0D2, P0D3, P1C0, BEEP<br>V <sub>OL</sub> = 0.5 V   | 0.5                 |      |                      | mA   |
|                            | I <sub>OL2</sub>  | EO<br>V <sub>OL</sub> = 0.5 V   | 0.2                 |      |                      | mA   |
|                            | I <sub>OL3</sub>  | P1B0-P1B3<br>V <sub>OL</sub> = 0.5 V  | 5                   |      |                      | μA   |
|                            | I <sub>OL4</sub>  | LCD0-LCD14<br>V <sub>OL</sub> = 0.5 V   | 20                  |      |                      | μA   |
| High-level input current   | I <sub>IH1</sub>  | When P1A0 through P1A3 are pulled down<br>V <sub>IH</sub> = V <sub>DD</sub> = 1.8 V   | 3                   |      | 30                   | μA   |
|                            | I <sub>IH2</sub>  | When X <sub>IN</sub> pin is pulled down<br>V <sub>IH</sub> = V <sub>DD</sub> = 1.8 V  | 40                  |      |                      | μA   |
| LCD drive voltage          | V <sub>LCD1</sub> | When LCD0 through LCD14 outputs are open<br>C1 = 0.1 μF, C2 = 0.01 μF<br>T <sub>A</sub> = 25 °C   | 2.8                 | 3.1  | 3.3                  | V    |
| Output off leakage current | I <sub>L</sub>    | EO  |                     |      | ±1                   | μA   |



**AC Characteristics (T<sub>A</sub> = -20 to +70 °C, V<sub>DD</sub> = 1.8 to 3.6 V)**

(2/2)

| Parameter           | Symbol           | Condition  | MIN. | TYP. | MAX. | Unit |
|---------------------|------------------|--|------|------|------|------|
| Operating frequency | f <sub>IN1</sub> | VCOL pin, MF mode, with sine wave input<br>V <sub>IN</sub> = 0.2 V <sub>p-p</sub>                    | 0.3  |      | 8    | MHz  |
|                     | f <sub>IN2</sub> | VCOL pin, HF mode, with sine wave input<br>V <sub>IN</sub> = 0.3 V <sub>p-p</sub>                    | 5    |      | 130  | MHz  |
|                     | f <sub>IN3</sub> | VCOH pin, VHF mode, with sine wave input<br>V <sub>IN</sub> = 0.2 V <sub>p-p</sub>                   | 40   |      | 230  | MHz  |
|                     | f <sub>IN4</sub> | FMIFC/AMIFC pin, AMIF count mode,<br>with sine wave input<br>V <sub>IN</sub> = 0.1 V <sub>p-p</sub>  | 400  |      | 500  | kHz  |
|                     | f <sub>IN5</sub> | FMIFC/AMIFC pin, AMIF count mode,<br>with sine wave input<br>V <sub>IN</sub> = 0.15 V <sub>p-p</sub> | 0.4  |      | 2    | MHz  |
|                     | f <sub>IN6</sub> | FMIFC/AMIFC pin, FMIF count mode,<br>with sine wave input<br>V <sub>IN</sub> = 0.1 V <sub>p-p</sub>  | 10   |      | 11   | MHz  |

**A/D Converter Characteristics (T<sub>A</sub> = -20 to +70 °C, V<sub>DD</sub> = 1.8 to 3.6 V)**

| Parameter                  | Symbol | Condition              | MIN. | TYP. | MAX. | Unit |
|----------------------------|--------|------------------------|------|------|------|------|
| A/D conversion resolution  |        |                        |      |      | 4    | bit  |
| A/D conversion total error |        | T <sub>A</sub> = 25 °C |      |      | ±1.5 | LSB  |

6. PACKAGE

56 PIN PLASTIC QFP (10×10)

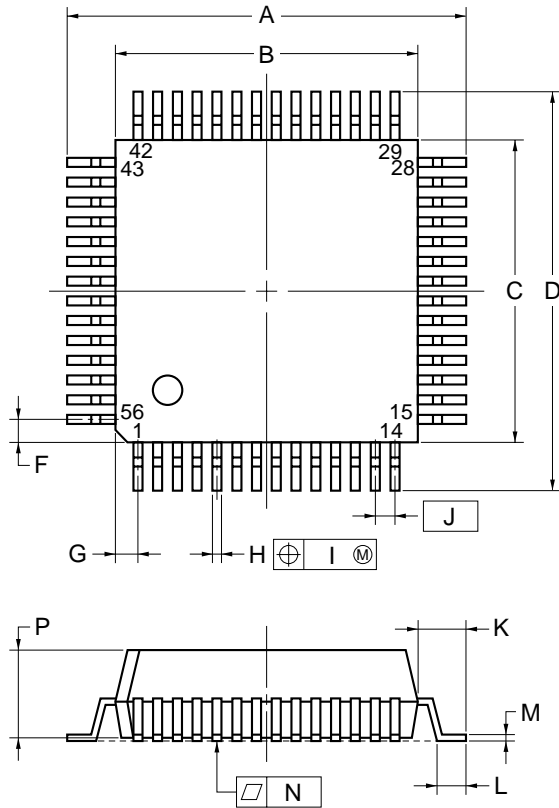

detail of lead end

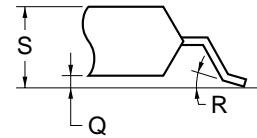

NOTE

Each lead centerline is located within 0.13 mm (0.005 inch) of its true position (T.P.) at maximum material condition.

| ITEM | MILLIMETERS                            | INCHES                                    |
|------|--|---|
| A    | 12.8±0.4                               | 0.504±0.016                               |
| B    | 10.0±0.2                               | 0.394±0.008                               |
| C    | 10.0±0.2                               | 0.394±0.008                               |
| D    | 12.8±0.4                               | 0.504±0.016                               |
| F    | 0.8                                    | 0.031                                     |
| G    | 0.8                                    | 0.031                                     |
| H    | 0.30±0.10                              | 0.012±0.004                               |
| I    | 0.13                                   | 0.005                                     |
| J    | 0.65 (T.P.)                            | 0.026 (T.P.)                              |
| K    | 1.4±0.2                                | 0.055±0.008                               |
| L    | 0.6±0.2                                | 0.024 <sup>+0.008</sup> <sub>-0.009</sub> |
| M    | 0.15 <sup>+0.10</sup> <sub>-0.05</sub> | 0.006 <sup>+0.004</sup> <sub>-0.003</sub> |
| N    | 0.10                                   | 0.004                                     |
| P    | 1.7                                    | 0.067                                     |
| Q    | 0.125±0.075                            | 0.005±0.003                               |
| R    | 5°±5°                                  | 5°±5°                                     |
| S    | 2.0 MAX.                               | 0.079 MAX.                                |

S56GB-65-1A7-3

[MEMO]

[MEMO]

[MEMO]

## NOTES FOR CMOS DEVICES

### ① PRECAUTION AGAINST ESD FOR SEMICONDUCTORS

**Note:** Strong electric field, when exposed to a MOS device, can cause destruction of the gate oxide and ultimately degrade the device operation. Steps must be taken to stop generation of static electricity as much as possible, and quickly dissipate it once, when it has occurred. Environmental control must be adequate. When it is dry, humidifier should be used. It is recommended to avoid using insulators that easily build static electricity. Semiconductor devices must be stored and transported in an anti-static container, static shielding bag or conductive material. All test and measurement tools including work bench and floor should be grounded. The operator should be grounded using wrist strap. Semiconductor devices must not be touched with bare hands. Similar precautions need to be taken for PW boards with semiconductor devices on it.

### ② HANDLING OF UNUSED INPUT PINS FOR CMOS

**Note:** No connection for CMOS device inputs can be cause of malfunction. If no connection is provided to the input pins, it is possible that an internal input level may be generated due to noise, etc., hence causing malfunction. CMOS device behave differently than Bipolar or NMOS devices. Input levels of CMOS devices must be fixed high or low by using a pull-up or pull-down circuitry. Each unused pin should be connected to  $V_{DD}$  or GND with a resistor, if it is considered to have a possibility of being an output pin. All handling related to the unused pins must be judged device by device and related specifications governing the devices.

### ③ STATUS BEFORE INITIALIZATION OF MOS DEVICES

**Note:** Power-on does not necessarily define initial status of MOS device. Production process of MOS does not define the initial operation status of the device. Immediately after the power source is turned ON, the devices with reset function have not yet been initialized. Hence, power-on does not guarantee out-pin levels, I/O settings or contents of registers. Device is not initialized until the reset signal is received. Reset operation must be executed immediately after power-on for devices having reset function.

## Regional Information

Some information contained in this document may vary from country to country. Before using any NEC product in your application, please contact the NEC office in your country to obtain a list of authorized representatives and distributors. They will verify:

- Device availability
- Ordering information
- Product release schedule
- Availability of related technical literature
- Development environment specifications (for example, specifications for third-party tools and components, host computers, power plugs, AC supply voltages, and so forth)
- Network requirements

In addition, trademarks, registered trademarks, export restrictions, and other legal issues may also vary from country to country.

### **NEC Electronics Inc. (U.S.)**

Santa Clara, California  
Tel: 800-366-9782  
Fax: 800-729-9288

### **NEC Electronics (Germany) GmbH**

Duesseldorf, Germany  
Tel: 0211-65 03 02  
Fax: 0211-65 03 490

### **NEC Electronics (UK) Ltd.**

Milton Keynes, UK  
Tel: 01908-691-133  
Fax: 01908-670-290

### **NEC Electronics Italiana s.r.l.**

Milano, Italy  
Tel: 02-66 75 41  
Fax: 02-66 75 42 99

### **NEC Electronics (Germany) GmbH**

Benelux Office  
Eindhoven, The Netherlands  
Tel: 040-2445845  
Fax: 040-2444580

### **NEC Electronics (France) S.A.**

Velizy-Villacoublay, France  
Tel: 01-30-67 58 00  
Fax: 01-30-67 58 99

### **NEC Electronics (France) S.A.**

Spain Office  
Madrid, Spain  
Tel: 01-504-2787  
Fax: 01-504-2860

### **NEC Electronics (Germany) GmbH**

Scandinavia Office  
Taeby, Sweden  
Tel: 08-63 80 820  
Fax: 08-63 80 388

### **NEC Electronics Hong Kong Ltd.**

Hong Kong  
Tel: 2886-9318  
Fax: 2886-9022/9044

### **NEC Electronics Hong Kong Ltd.**

Seoul Branch  
Seoul, Korea  
Tel: 02-528-0303  
Fax: 02-528-4411

### **NEC Electronics Singapore Pte. Ltd.**

United Square, Singapore 1130  
Tel: 253-8311  
Fax: 250-3583

### **NEC Electronics Taiwan Ltd.**

Taipei, Taiwan  
Tel: 02-719-2377  
Fax: 02-719-5951

### **NEC do Brasil S.A.**

Sao Paulo-SP, Brasil  
Tel: 011-889-1680  
Fax: 011-889-1689

## [MEMO]

Purchase of NEC I<sup>2</sup>C components conveys a license under the Philips I<sup>2</sup>C Patent Rights to use these components in an I<sup>2</sup>C system, provided that the system conforms to the I<sup>2</sup>C Standard Specification as defined by Philips.

No part of this document may be copied or reproduced in any form or by any means without the prior written consent of NEC Corporation. NEC Corporation assumes no responsibility for any errors which may appear in this document.

NEC Corporation does not assume any liability for infringement of patents, copyrights or other intellectual property rights of third parties by or arising from use of a device described herein or any other liability arising from use of such device. No license, either express, implied or otherwise, is granted under any patents, copyrights or other intellectual property rights of NEC Corporation or others.

While NEC Corporation has been making continuous effort to enhance the reliability of its semiconductor devices, the possibility of defects cannot be eliminated entirely. To minimize risks of damage or injury to persons or property arising from a defect in an NEC semiconductor device, customers must incorporate sufficient safety measures in its design, such as redundancy, fire-containment, and anti-failure features.

NEC devices are classified into the following three quality grades:

"Standard", "Special", and "Specific". The Specific quality grade applies only to devices developed based on a customer designated "quality assurance program" for a specific application. The recommended applications of a device depend on its quality grade, as indicated below. Customers must check the quality grade of each device before using it in a particular application.

Standard: Computers, office equipment, communications equipment, test and measurement equipment, audio and visual equipment, home electronic appliances, machine tools, personal electronic equipment and industrial robots

Special: Transportation equipment (automobiles, trains, ships, etc.), traffic control systems, anti-disaster systems, anti-crime systems, safety equipment and medical equipment (not specifically designed for life support)

Specific: Aircrafts, aerospace equipment, submersible repeaters, nuclear reactor control systems, life support systems or medical equipment for life support, etc.

The quality grade of NEC devices is "Standard" unless otherwise specified in NEC's Data Sheets or Data Books. If customers intend to use NEC devices for applications other than those specified for Standard quality grade, they should contact an NEC sales representative in advance.

Anti-radioactive design is not implemented in this product.