

MOS INTEGRATED CIRCUITS

μ PD1708AG-021, μ PD1708AG-221

PLL FREQUENCY SYNTHESIZER AND CONTROLLER FOR MOBILE FM/AM RADIO WITH CLOCK

The μ PD1708AG-021, μ PD1708AG-221, a CMOS LSI chip developed for a PLL frequency synthesizer FM/AM radio for all territories with the exception of Europe. In outward appearance it is a 52-pin flat package. Because it has a built-in prescaler and an LCD driver in addition to a PLL frequency synthesizer and controller, it is possible to construct a clock-equipped high performance FM/MW digital tuning system for car stereos, home stereos, and radio cassettes.

FEATURES

- LCD direct drive possible (1/2 duty, 1/2 bias drive, frame frequency: 100 Hz)
- Built-in prescaler
- Built-in 12-hours display clock function
- Preset memory of 6 stations each for FM and AM using 6 buttons
- Manual UP/DOWN, and auto-UP/DOWN (SCAN/SEEK) station selection (sawtooth wave tuning)
- FM/AM selection possible for the U.S.A., Australia, Japan, and South Africa, as well as Central America and the Middle East
- The Japanese AM band has wide band range (522 to 1 629 kHz) for automotive radio information.
- Last channel memory – one station each FM/AM
- STEREO display possible
- Preset memory display (numeric display)
- Has TAPE function, METAL, Dolby NR *, MSS control possible
- LOUDNESS control possible
- 5 V \pm 10 % single power supply
- 52-pin flat package
- Two types of lead format

Lead bended type: μ PD1708AG-021-00

Straight lead type: μ PD1708AG-221-03

* Dolby® and the double-D symbol are registered trademarks of Dolby Laboratories Licensing Corporation.

FUNCTION

Receiving Frequency, Channel Spacing, Reference Frequency, Intermediate Frequency

DISTRICT	ITEM		RECEIVING FREQUENCY	CHANNEL SPACING	REFERENCE FREQUENCY	INTERMEDIATE FREQUENCY
	BAND					
Japan	AM		522 to 1 629 kHz	9 kHz	9 kHz	450 kHz
	FM		76.0 to 90.0 MHz	100 kHz	25 kHz	-10.7 MHz
U.S.A.	AM		530 to 1 620 kHz	10 kHz	10 kHz	450 kHz
	FM		37.9 to 107.9 MHz	200 kHz	25 kHz	10.7 MHz
Latin America	AM		530 to 1 620 kHz	5 kHz	5 kHz	450 kHz
	FM		87.5 to 107.9 MHz	100 kHz	25 kHz	10.7 MHz
Australia	AM		531 to 1 602 kHz	9 kHz	9 kHz	450 kHz
Middle East	FM		87.5 to 107.9 MHz	100 kHz	25 kHz	10.7 MHz
South Africa	AM		531 to 1 602 kHz	9 kHz	9 kHz	450 kHz
	FM		87.604 to 107.900 MHz	86 kHz (NOTE)	5 kHz	-10.7 MHz

NOTE: Moves UP/DOWN in 80 kHz or 90 kHz steps to a frequency closest to the proper channel plan. (Maximum error ± 4 kHz).
The display indicates "0" when the 10 kHz column is 0 to 4, "5" when 5 to 9. 1 kHz column is not shown.

Station Selection Function

- (1) Auto-tuning (sawtooth wave mode)
 - SCAN up, down 5 seconds at a time receiving
 - SEEK up, down Once received, station held
- (2) Manual tuning (sawtooth wave mode)
 - Manual up, down Stepwise feed by a push switch. On depressing switch for more than 0.5 seconds, feeds continuously until released.
- (3) Preset memory access
 - FM and AM independently can access 6 stations each with 6 buttons. There is last station memory for each band.

TAPE Function

- (1) Tape feed display
- (2) METAL control
- (3) Dolby NR control
- (4) MSS control

Clock Function

- (1) 12-hours display (with AM and PM display)
 - 1 Hz flashing or continuous lighting for the colon can be selected.

Other Function

- (1) LOUDNESS control

PIN CONFIGURATION (Top View)

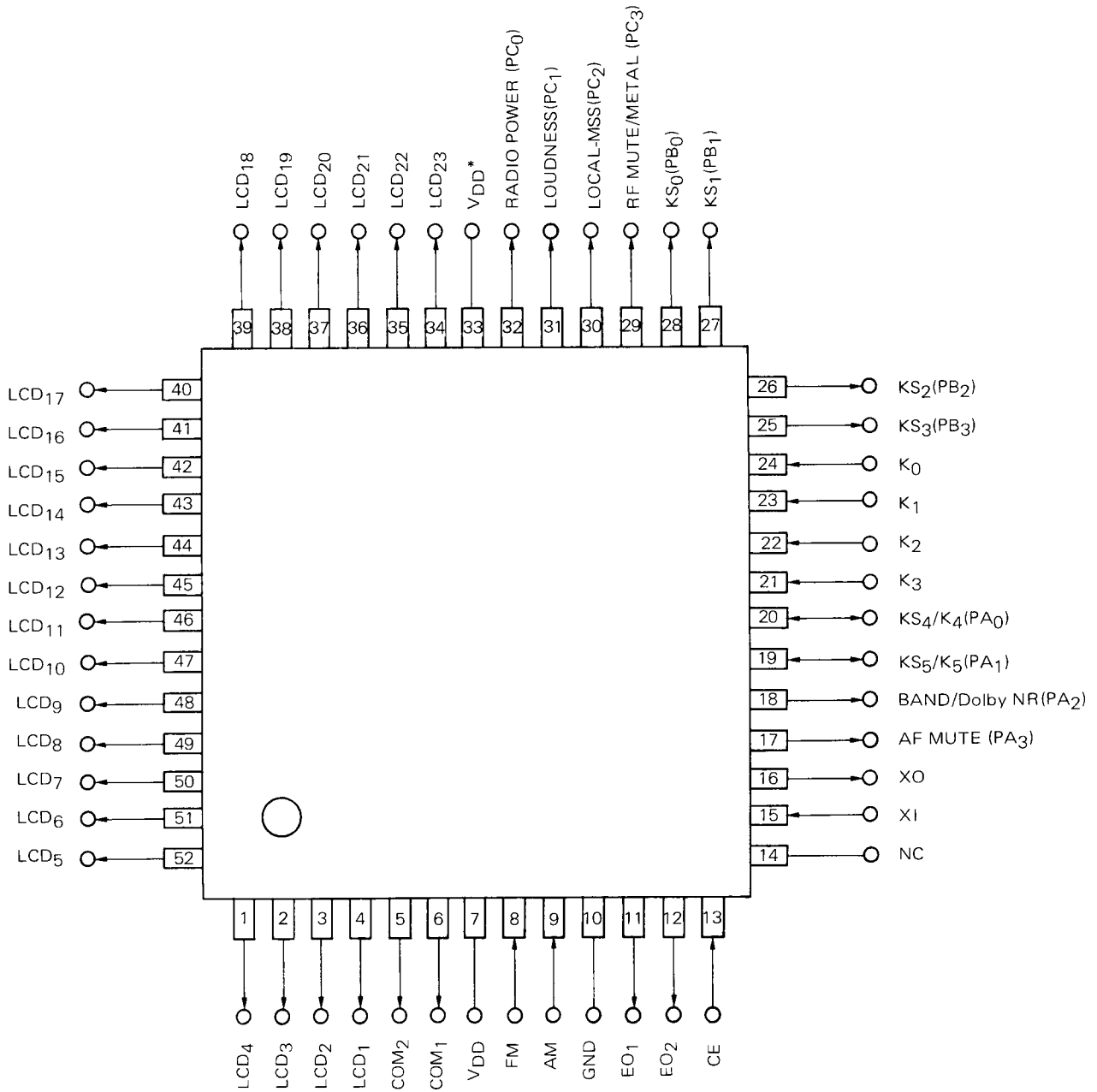

*: Connected internally to pin 7.

NC: No Connection

PIN DESCRIPTION

PIN NO.	SYMBOL	NAME	DESCRIPTION	OUTPUT TYPE
1 to 4 34 to 52	LCD ₁ to LCD ₂₃	LCD segment output	Those pins outputs the LCD segment signal. (1/2-duty, 1/2-bias LCD is used. Frame frequency is 100 Hz and drive voltage is V _{DD} .)	CMOS push-pull
5 6	COM ₂ COM ₁	LCD common output	Those are the LCD common output pins.	CMOS push-pull
7 33	V _{DD}	Power Supply	This is the power supply pin for the device. A 5 ±10 % voltage is applied when the device is operated. It is also possible to supply power to any of the two, pins #7 to #33. A V _{DD} rise time of less than 500 ms (0 to 4.5 V) is required. When the rise time is extremely long, or when V _{DD} does not fall completely to zero and rise again up to 4.5 V from less than the operating voltage, the status of the initialization diode switch may not read correctly. In such a case, the status of the initialization diode switch can be read using the CE pin.	—
8	FM	FM VCO input signal	This pin inputs the FM local output. Cut the DC current at the condenser since the AC amplifier is incorporated	Input
9	AM	AM VCO input signal	This pin inputs the AM local output. Cut the DC current at the condenser since the AC amplifier is incorporated.	Input
10	GND	Ground	Ground the set using this pin.	—
11 12	EO ₁ EO ₂	Error output	This is the charge pump output for the phase detector making up the PLL. When the divided generated frequency is higher than the standard frequency, a high-level output is obtained from these pins, and, conversely, when it is lower than the standard frequency, a low-level output results. If they are in agreement, floating results. Because the same signal is output simultaneously from EO ₁ and EO ₂ , they may be connected to either the AM or FM low pass filter (LPF).	CMOS 3-state
13	CE	Chip Enable	This is the device selection signal input pin. High level to operate PLL, and Low level to stop PLL. Either the clock display or blank can be selected by the diode matrix for low level. However, a low level less than 134 μs, or a high level, is not received.	Input
15 16	XI XO	X'tal	These are the crystal oscillator connection pin. These are connected to a 4.5 MHz crystal oscillator.	Input (XI) CMOS (XO)
17	AF MUTE	Mute output	This pin outputs a muting signal to eliminate the shock noise when the PLL lock is released, and the pop noise when switching between TAPE and RADIO. It is active-high. For timing details, see the Timing Charts.	CMOS push-pull (I/O)

PIN NO.	SYMBOL	NAME	DESCRIPTION	OUTPUT TYPE
18	BAND/ Dolby NR	BAND and Dolby NR output	<p>In RADIO mode: This is the pin for the FM and AM band switching signal output. High-level is output when the FM band is selected, and low level when the AM band is selected.</p> <p>In TAPE mode: This is the Dolby NR ON/OFF signal output pin. "NR" lights up on the LCD panel for high-level, and is extinguished for low-level output. When first powered up (when V_{DD} rises), the low-level is output. (AM band, or Dolby NR OFF)</p>	CMOS push-pull (I/O)
19 20	KS ₅ /K ₅ KS ₄ /K ₄	Key-return: signal source, and key-return signal input	<p>Only when first powered up (when V_{DD} builds up) or on returning to back-up status (CE low → high), these act as incorporated key-return output pins for the initialization diode matrix.</p> <p>In any other case, these act as the key-return signal input pins for the key matrix. Attach a pull-down resistance.</p>	CMOS push-pull (I/O)
21 to 24	K ₃ to K ₀	Key-return signal input	<p>This is the key-return signal input pin for the key matrix. Attach a pull-down resistance.</p>	Input
25 to 28	KS ₃ to KS ₀	Key-return signal input	<p>This is the key-return signal output pin for the key matrix. From the aspect of construction, especially because the sync current becomes low, a diode for preventing reverse current from the key source side can be omitted.</p>	CMOS push-pull
29	RF MUTE/ METAL	RF MUTE and METAL output	<p>In RADIO mode: When auto-tuning, this is the pin for the outage gain control signal output.</p> <p>When the auto-scanning key (SEEK DWN, SEEK UP, SCAN DWN, SCAN UP) is depressed, there is about a 60-ms delay from the AF-MUTE until high-level is reached, and high-level is maintained during the search.</p> <p>In TAPE mode: This is the METAL ON/OFF signal output pin. "MTL" lights up on the LCD panel for high-level, and is extinguished for low-level output. When first powered up (when V_{DD} rises), the low-level is output.</p>	CMOS push-pull

PIN NO.	SYMBOL	NAME	DESCRIPTION	OUTPUT TYPE
30	LOCAL-MSS	LOCAL/DX and MSS output	<p>In RADIO mode: When auto-tuning, this is the pin for the outage gain control signal output. When no broadcasting station is found after even one search from the frequency of the signal being received, "DX" lights up on the LCD panel, and low-level is output. When the "DX" display is extinguished, high-level is output.</p> <p>In TAPE mode: This is the MSS ON/OFF signal output pin. "MSS" lights up on the LCD panel for high-level, and is extinguished for low-level output. When first powered up (when V_{DD} builds up), the low-level is output.</p>	CMOS push-pull
31	LOUDNESS	LOUDNESS signal output	<p>This is the pin for the LOUDNESS signal output. "LOU" lights up on the LCD panel for high-level, and is extinguished for low-level output. When first powered up (when V_{DD} builds up), the low-level is output.</p>	CMOS push-pull
32	RADIO POWER	RADIO ON/OFF output	<p>This is the RADIO power source ON/OFF signal output pin when the momentary key system is selected for the radio power source system (diode switch RADSW = ON). The output is high-level for RADIO ON and low-level for OFF.</p>	CMOS push-pull

CONTENTS

1. KEY MATRIX	8
1.1 CONFIGURATION OF KEY MATRIX	8
1.2 SWITCH CONNECTION	8
1.3 KEY MATRIX CONNECTION	9
1.4 DESCRIPTION OF KEY MATRIX	10
2. DISPLAY	17
2.1 LCD PANEL	17
2.2 CHARACTER FORMS	17
2.3 LCD PATTERN	17
2.4 DISPLAY DESCRIPTION	18
2.5 LCD DRIVE WAVEFORM	19
3. TIMING CHARTS	20
4. FM BAND FREQUENCY TABLE FOR SOUTH AFRICA	22
5. APPLICATION CIRCUIT	27
6. ELECTRICAL CHARACTERISTICS	28
6.1 ABSOLUTE MAXIMUM RATINGS	28
6.2 RECOMMENDED OPERATING CONDITIONS	28
6.3 DC CHARACTERISTICS	29
6.4 AC CHARACTERISTICS	29
7. PACKAGE DIMENSIONS	30

1. KEY MATRIX

1.1 CONFIGURATION OF KEY MATRIX

Input pin \ Output pin	K ₅ (19)	K ₄ (20)	K ₃ (21)	K ₂ (22)	K ₁ (23)	K ₀ (24)
KS ₀ (28)	SEEK DWN	SEEK UP	—	LOUD	ZADJ	ME
KS ₁ (27)	MAN DWN	MAN UP	M4	M3 (Dolby NR)	M2 (METAL)	M1 (MSS)
KS ₂ (26)	SCAN DWN	SCAN UP	M6	M5	DISP	BAND
KS ₃ (25)	—	—	MODE	SD(REW)	ST (F/F)	RADIO ON/OFF
KS ₄ (20)	—	—				
KS ₅ (19)	—	—				

() : Pin No.



: Momentary switch



: Alternate switch or transistor switch

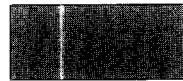

: Diode matrix (Diode short circuit or open)

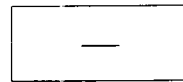

: Open

1.2 SWITCH CONNECTION

Momentary Switch

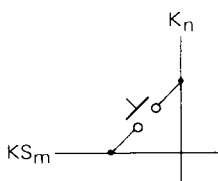

Alternate Switch

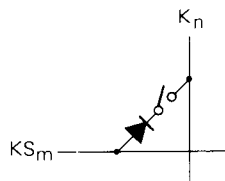

Diode Matrix

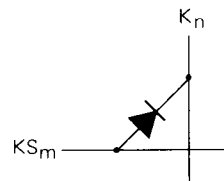

or

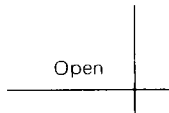

Open

Transistor Switch

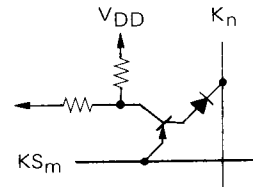

1.3 KEY MATRIX CONNECTION

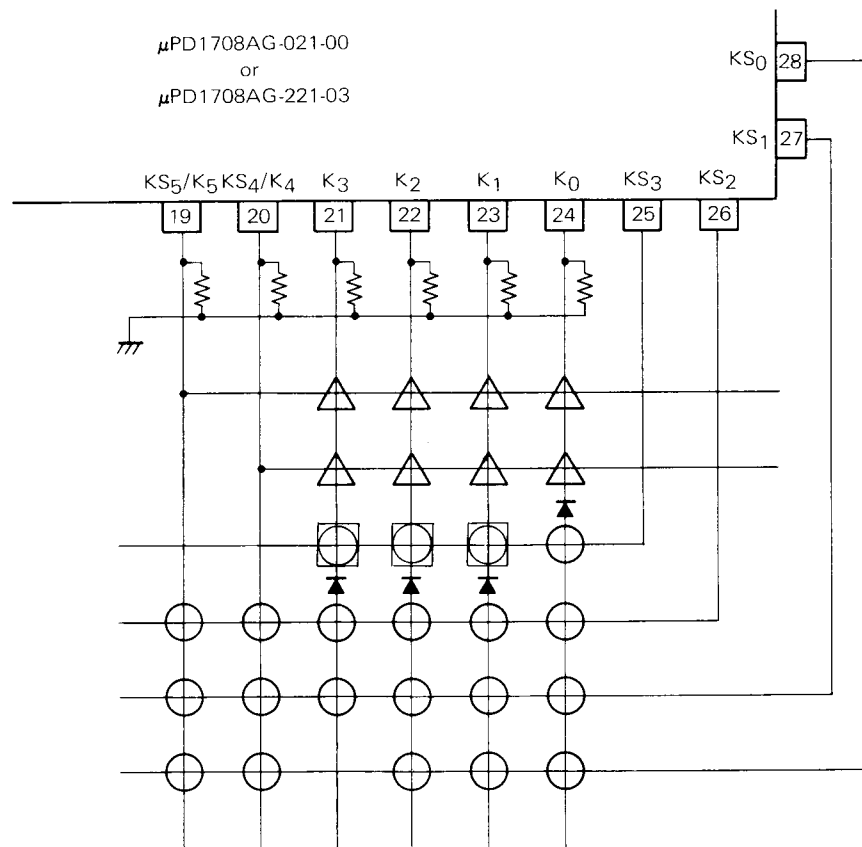
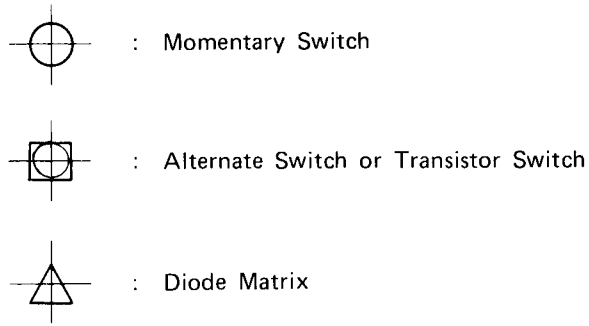

1.4 DESCRIPTION OF KEY MATRIX

1.4.1 INITIALIZATION DIODE MATRIX

There are five types of initialization diode matrices, as follows. They are all read only when V_{DD} is first powered up (Power-ON Reset) or when the CE pin voltage changes from low to high (CE reset). At any other time the diode matrix status is ignored.

- (1) Switch for setting the receiving frequency range and the channel space.
FMBND1, FMBND0, AMBND1, AMBND0
- (2) Switch for selecting RADIO power system
RADSW
- (3) Switch for selecting clock or no clock
CLKSEL
- (4) Switch for selecting display priority
PRIO
- (5) Switch for selecting display when RADIO OFF
CELDSP

Make these settings by making the nodal points on the matrix close or open using diode. (In the following table, "1" means the diode is closed, "0" opened).

SYMBOL	DESCRIPTION																				
FMBND0 FMBND1	<p>These switches are for setting the receiving frequency range of the FM band and for setting the channel space. The settings are as follows.</p> <table border="1" data-bbox="395 256 1257 472"> <thead> <tr> <th>FMBND1</th> <th>FMBND0</th> <th>FREQUENCY RANGE</th> <th>CHANNEL SPACING</th> </tr> </thead> <tbody> <tr> <td>0</td> <td>0</td> <td>87.9 to 107.9 MHz</td> <td>200 kHz</td> </tr> <tr> <td>0</td> <td>1</td> <td>87.5 to 107.9 MHz</td> <td>100 kHz</td> </tr> <tr> <td>1</td> <td>0</td> <td>76.0 to 90.0 MHz</td> <td>100 kHz</td> </tr> <tr> <td>1</td> <td>1</td> <td>87.604 to 107.900 MHz</td> <td>86 kHz</td> </tr> </tbody> </table>	FMBND1	FMBND0	FREQUENCY RANGE	CHANNEL SPACING	0	0	87.9 to 107.9 MHz	200 kHz	0	1	87.5 to 107.9 MHz	100 kHz	1	0	76.0 to 90.0 MHz	100 kHz	1	1	87.604 to 107.900 MHz	86 kHz
FMBND1	FMBND0	FREQUENCY RANGE	CHANNEL SPACING																		
0	0	87.9 to 107.9 MHz	200 kHz																		
0	1	87.5 to 107.9 MHz	100 kHz																		
1	0	76.0 to 90.0 MHz	100 kHz																		
1	1	87.604 to 107.900 MHz	86 kHz																		
AMBND0 AMBND1	<p>These switches are for setting the receiving frequency range of the AM band and for setting the channel space. The settings are as follows.</p> <table border="1" data-bbox="395 567 1257 783"> <thead> <tr> <th>AMBND1</th> <th>AMBND0</th> <th>FREQUENCY RANGE</th> <th>CHANNEL SPACING</th> </tr> </thead> <tbody> <tr> <td>0</td> <td>0</td> <td>530 to 1 620 kHz</td> <td>10 kHz</td> </tr> <tr> <td>0</td> <td>1</td> <td>530 to 1 620 kHz</td> <td>5 kHz</td> </tr> <tr> <td>1</td> <td>0</td> <td>522 to 1 629 kHz</td> <td>9 kHz</td> </tr> <tr> <td>1</td> <td>1</td> <td>531 to 1 602 kHz</td> <td>9 kHz</td> </tr> </tbody> </table>	AMBND1	AMBND0	FREQUENCY RANGE	CHANNEL SPACING	0	0	530 to 1 620 kHz	10 kHz	0	1	530 to 1 620 kHz	5 kHz	1	0	522 to 1 629 kHz	9 kHz	1	1	531 to 1 602 kHz	9 kHz
AMBND1	AMBND0	FREQUENCY RANGE	CHANNEL SPACING																		
0	0	530 to 1 620 kHz	10 kHz																		
0	1	530 to 1 620 kHz	5 kHz																		
1	0	522 to 1 629 kHz	9 kHz																		
1	1	531 to 1 602 kHz	9 kHz																		
RADSW	<p>This switch is for selecting the RADIO power system — either the momentary key system or the alternate key system.</p> <p>0 . . . Alternate system (CE pin used) 1 . . . Momentary system (CE pin high, RADIO ON/OFF key used)</p>																				
CLKSEL	<p>This switch is for selecting clock or no clock.</p> <p>0 . . . No clock 1 . . . Clock</p>																				
PRIO	<p>This switch is for selecting the display priority mode when the clock function is used. When the posterior display is specified, it is replaced with the prior mode display after approx. 5 s.</p> <p>0 . . . Clock display priority 1 . . . Frequency display priority</p>																				
CELDSP	<p>This switch is for selecting the display during RADIO-OFF, when the clock function is being used.</p> <p>0 . . . Blank 1 . . . Clock display</p>																				

1.4.2 SWITCH FOR SWITCHING MODE

This switch differs from the initialization switch inasmuch as it can be switched at anytime. (In the following table, "1" means ON, "0" OFF).

SYMBOL	DESCRIPTION
MODE	Sets RADIO mode or TAPE mode 1 . . . TAPE mode 0 . . . RADIO mode
SD(REW)	In RADIO mode: The station detector input switch for SEEK and SCAN. Within about 50 ms after the PLL locks it must be turned OFF. At alternate 1 ms intervals five searches are made, and if all of them go OFF after five searches it is presumed that a broadcasting station has been received, and SEEK and SCAN come to a halt. In TAPE mode: This switch inputs the display of the direction of tape travel. "◀" is displayed on the LCD panel when the switch is ON.
ST (F/F)	In RADIO mode: This is the stereo signal input switch. "ST" is displayed on the LCD panel when this switch is OFF. However, even with this switch OFF, during the clock display and when auto-tuning (AF-MUTE pin active), "ST" display disappears. In TAPE mode: This switch inputs the display of the direction of tape travel. "▶" is displayed on the LCD panel when the switch is ON.

1.4.3 MOMENTARY SWITCH-

SYMBOL	DESCRIPTION																																																																																																			
<div style="border: 1px solid black; padding: 2px; width: fit-content; margin-bottom: 5px;">MAN UP</div> <div style="border: 1px solid black; padding: 2px; width: fit-content;">MAN DWN</div>	<p>This key is for manual tuning or clock adjustment.</p> <ul style="list-style-type: none"> ○ During frequency display Each time this key is depressed the frequency moves one step up or down. If the key is depressed for more than 0.5 seconds continuously, the action will continue until the key is released. ○ During time display By depressing the MAN UP or MAN DWN key while holding the ME key down, the hour column or minute column can be adjusted. 																																																																																																			
<div style="border: 1px solid black; padding: 2px; width: fit-content; margin-bottom: 5px;">M1</div> <div style="border: 1px solid black; padding: 2px; width: fit-content; margin-bottom: 5px;">M2</div> <div style="border: 1px solid black; padding: 2px; width: fit-content; margin-bottom: 5px;">M3</div> <div style="border: 1px solid black; padding: 2px; width: fit-content; margin-bottom: 5px;">M4</div> <div style="border: 1px solid black; padding: 2px; width: fit-content; margin-bottom: 5px;">M5</div> <div style="border: 1px solid black; padding: 2px; width: fit-content;">M6</div>	<p>In RADIO mode:</p> <p>This key is for preset memory write-in or access. FM and AM can be stored in memory independently using one button.</p> <p>(1) Write-in While the frequency is being displayed, by depressing any one of the M1 to M6 keys within 5 seconds after the ME key has been depressed the frequency of the present reception will be written into memory, corresponding to the key which is being depressed.</p> <p>(2) Access On pressing any one of the M1 to M6 keys, the contents of memory (frequency) corresponding to that key will be accessed.</p> <p>When V_{DD} is first powered up and the radio comes ON, the lowest frequency in the AM band is accessed. The following frequencies are stored in the memory corresponding M1 to M6 for the convenience of adjustment at the time of mass production of the set.</p> <table border="1" data-bbox="411 1197 1406 1783"> <thead> <tr> <th rowspan="2">DISTRICT</th> <th rowspan="2">ITEM BAND</th> <th rowspan="2">RECEIVING FREQUENCY</th> <th>M1</th> <th>M2</th> <th>M3</th> <th>M4</th> <th>M5</th> <th>M6</th> </tr> </thead> <tbody> <tr> <td>Japan</td> <td>AM</td> <td>522 to 1629 kHz</td> <td>531</td> <td>603</td> <td>999</td> <td>1404</td> <td>1629</td> <td>1620</td> </tr> <tr> <td></td> <td>FM</td> <td>76.0 to 90.0 MHz</td> <td>76.0</td> <td>78.0</td> <td>83.0</td> <td>88.0</td> <td>90.0</td> <td>76.0</td> </tr> <tr> <td>U.S.A.</td> <td>AM</td> <td>530 to 1620 kHz</td> <td>530</td> <td>600</td> <td>1000</td> <td>1400</td> <td>1610</td> <td>530</td> </tr> <tr> <td></td> <td>FM</td> <td>87.9 to 107.9 MHz</td> <td>87.9</td> <td>90.1</td> <td>98.1</td> <td>106.1</td> <td>107.9</td> <td>87.9</td> </tr> <tr> <td>Latin America</td> <td>AM</td> <td>530 to 1620 kHz</td> <td>530</td> <td>600</td> <td>1000</td> <td>1400</td> <td>1610</td> <td>530</td> </tr> <tr> <td></td> <td>FM</td> <td>87.5 to 107.9 MHz</td> <td>87.9</td> <td>90.1</td> <td>98.1</td> <td>106.1</td> <td>107.9</td> <td>87.9</td> </tr> <tr> <td>Australia</td> <td>AM</td> <td>531 to 1602 kHz</td> <td>531</td> <td>603</td> <td>999</td> <td>1404</td> <td>531</td> <td>531</td> </tr> <tr> <td>Middle East</td> <td>FM</td> <td>87.5 to 107.9 MHz</td> <td>87.9</td> <td>90.1</td> <td>98.1</td> <td>106.1</td> <td>107.9</td> <td>87.9</td> </tr> <tr> <td>South Africa</td> <td>AM</td> <td>531 to 1602 kHz</td> <td>531</td> <td>603</td> <td>999</td> <td>1404</td> <td>531</td> <td>531</td> </tr> <tr> <td></td> <td>FM</td> <td>87.604 to 107.900 MHz</td> <td>(NOTE) 87.6</td> <td>(NOTE) 89.3</td> <td>(NOTE) 93.6</td> <td>(NOTE) 97.9</td> <td>(NOTE) 99.6</td> <td>(NOTE) 87.6</td> </tr> </tbody> </table> <p>(Note) Normal frequencies, which are differ from actual receive frequencies.</p>	DISTRICT	ITEM BAND	RECEIVING FREQUENCY	M1	M2	M3	M4	M5	M6	Japan	AM	522 to 1629 kHz	531	603	999	1404	1629	1620		FM	76.0 to 90.0 MHz	76.0	78.0	83.0	88.0	90.0	76.0	U.S.A.	AM	530 to 1620 kHz	530	600	1000	1400	1610	530		FM	87.9 to 107.9 MHz	87.9	90.1	98.1	106.1	107.9	87.9	Latin America	AM	530 to 1620 kHz	530	600	1000	1400	1610	530		FM	87.5 to 107.9 MHz	87.9	90.1	98.1	106.1	107.9	87.9	Australia	AM	531 to 1602 kHz	531	603	999	1404	531	531	Middle East	FM	87.5 to 107.9 MHz	87.9	90.1	98.1	106.1	107.9	87.9	South Africa	AM	531 to 1602 kHz	531	603	999	1404	531	531		FM	87.604 to 107.900 MHz	(NOTE) 87.6	(NOTE) 89.3	(NOTE) 93.6	(NOTE) 97.9	(NOTE) 99.6	(NOTE) 87.6
DISTRICT	ITEM BAND				RECEIVING FREQUENCY	M1	M2	M3	M4	M5	M6																																																																																									
		Japan	AM	522 to 1629 kHz		531	603	999	1404	1629	1620																																																																																									
	FM	76.0 to 90.0 MHz	76.0	78.0	83.0	88.0	90.0	76.0																																																																																												
U.S.A.	AM	530 to 1620 kHz	530	600	1000	1400	1610	530																																																																																												
	FM	87.9 to 107.9 MHz	87.9	90.1	98.1	106.1	107.9	87.9																																																																																												
Latin America	AM	530 to 1620 kHz	530	600	1000	1400	1610	530																																																																																												
	FM	87.5 to 107.9 MHz	87.9	90.1	98.1	106.1	107.9	87.9																																																																																												
Australia	AM	531 to 1602 kHz	531	603	999	1404	531	531																																																																																												
Middle East	FM	87.5 to 107.9 MHz	87.9	90.1	98.1	106.1	107.9	87.9																																																																																												
South Africa	AM	531 to 1602 kHz	531	603	999	1404	531	531																																																																																												
	FM	87.604 to 107.900 MHz	(NOTE) 87.6	(NOTE) 89.3	(NOTE) 93.6	(NOTE) 97.9	(NOTE) 99.6	(NOTE) 87.6																																																																																												

SYMBOL	DESCRIPTION
<div style="display: flex; flex-direction: column; gap: 5px;"> <div style="border: 1px solid black; padding: 2px; width: 40px; text-align: center;">M1</div> <div style="border: 1px solid black; padding: 2px; width: 40px; text-align: center;">M2</div> <div style="border: 1px solid black; padding: 2px; width: 40px; text-align: center;">M3</div> <div style="border: 1px solid black; padding: 2px; width: 40px; text-align: center;">M4</div> <div style="border: 1px solid black; padding: 2px; width: 40px; text-align: center;">M5</div> <div style="border: 1px solid black; padding: 2px; width: 40px; text-align: center;">M6</div> </div>	<p>In TAPE mode:</p> <p>In TAPE mode, M1 to M3 are used as the MSS, METAL, and Dolby NR switching keys, respectively.</p> <p>Keys M4 to M6 are invalid.</p> <ul style="list-style-type: none"> ○ M1 (MSS) <ul style="list-style-type: none"> Used as the MSS switching key. Each time the key is depressed, the MSS pin output and the "MSS" display on the LCD panel reverse. When the "MSS" display lights up on the LCD panel, a high output is produced at the MSS pin, and when it disappears the output becomes low. ○ M2 (METAL) <ul style="list-style-type: none"> Used as the METAL switching key. Each time the key is depressed, the METAL pin output and the "MTL" display on the LCD panel reverse. When the "MTL" display lights up on the LCD panel, a high output is produced at the METAL pin, and when it disappears the output becomes low. ○ M3 (Dolby NR) <ul style="list-style-type: none"> Used as the Dolby NR switching key. Each time the key is depressed, the Dolby NR pin output and the "NR" display on the LCD panel reverse. When the "NR" display lights up on the LCD panel, a high output is produced at the Dolby NR pin, and when it disappears the output becomes low.
<div style="display: flex; flex-direction: column; gap: 5px;"> <div style="border: 1px solid black; padding: 2px; width: 60px; text-align: center;">SEEK UP</div> <div style="border: 1px solid black; padding: 2px; width: 60px; text-align: center;">SEEK DWN</div> </div>	<p>These are the auto-tuning keys. If the SD switch is turned OFF during auto-tuning, the frequency at that time is held.</p> <p>Even if the LOUD , ZADJ , or ME keys are pressed during auto-tuning, the auto-tuning action continues.</p> <p>If any other key is pressed, the auto-tuning halts and the action switches to the operation of the key which was pressed.</p>
<div style="display: flex; flex-direction: column; gap: 5px;"> <div style="border: 1px solid black; padding: 2px; width: 60px; text-align: center;">SCAN UP</div> <div style="border: 1px solid black; padding: 2px; width: 60px; text-align: center;">SCAN DWN</div> </div>	<p>These are the auto-tuning keys. If the SD switch is turned OFF during auto-tuning, the frequency at that time is held for 5 seconds, and during that interval, if the SCAN UP or SCAN DWN keys are pressed that frequency continues to be received unchanged. If no action occurs during that 5 second interval, the auto-tuning action recommences.</p> <p>Even if the LOUD , ZADJ , or ME keys are pressed during auto-tuning, the auto-tuning action continues.</p> <p>However, if the ME key is depressed during 5 seconds of receiving, the scanning action halts and it is possible to write into memory.</p> <p>If any other key is pressed, the auto-tuning halts and the action switches to the operation of the key which was pressed.</p>

SYMBOL	DESCRIPTION
<div style="border: 1px solid black; padding: 2px; width: fit-content; margin: 10px auto;">ME</div>	<p>This is the preset memory write-in key. It is also used for adjusting the clock during clock display.</p> <p>During frequency display</p> <p>Used when a new frequency is stored in preset memory. On pressing this key, "ME" is displayed on the LCD panel and remains lighted for five seconds after the key is released. During the period that "ME" is being displayed, if any one of the M1 to M6 keys are pressed, the frequency being displayed at that time is stored in the memory corresponding to the key which was activated.</p> <p>To erase an entry from memory, depress any key other than M1 to M6, <div style="border: 1px solid black; padding: 2px; display: inline-block;">ME</div>, or <div style="border: 1px solid black; padding: 2px; display: inline-block;">LOUD</div>.</p> <p>During clock display</p> <p>The "hours" and "minutes" can be adjusted by depressing either the <div style="border: 1px solid black; padding: 2px; display: inline-block;">MAN UP</div> or <div style="border: 1px solid black; padding: 2px; display: inline-block;">MAN DWN</div> key while holding the <div style="border: 1px solid black; padding: 2px; display: inline-block;">ME</div> key down.</p> <p>If the <div style="border: 1px solid black; padding: 2px; display: inline-block;">MAN UP</div> key is pressed after pressing the <div style="border: 1px solid black; padding: 2px; display: inline-block;">ME</div> key, the time will be advanced by one hour each time the key is pressed. In addition, if this key is pressed for more than 0.5 seconds continuously, the time will continuously advance at the rate of 4 hours per second until the key is released. This adjustment has no effect on the minutes and seconds (not displayed) columns.</p> <p>If the <div style="border: 1px solid black; padding: 2px; display: inline-block;">MAN DWN</div> key is pressed after pressing the <div style="border: 1px solid black; padding: 2px; display: inline-block;">ME</div> key, the time will be advanced by one minute each time the key is pressed. In addition, if this key is pressed for more than 0.5 seconds continuously, the time will continuously advance at the rate of 8 minutes per second until the key is released. Seconds are not displayed but they are reset to zero each time this revision is made. The hours column is not affected.</p>
<div style="border: 1px solid black; padding: 2px; width: fit-content; margin: 10px auto;">ZADJ</div>	<p>Used when a time adjustment is made during the clock display. On pressing this key, internal seconds counter is reset, and minutes column is reset when the column contains a figure of 29 or less, which results in zero-minute zero-second. This display is also made when the minutes column contains a figure of 30 or more, where a number in the hours column will be advanced by one.</p>
<div style="border: 1px solid black; padding: 2px; width: fit-content; margin: 10px auto;">BAND</div>	<p>This key is for switching bands.</p> <p>Each time the key is depressed the band changes from FM to AM or vice versa.</p> <p>When first powered up (when V_{DD} builds up), the frequency in preset memory M1 for the AM band is accessed.</p>
<div style="border: 1px solid black; padding: 2px; width: fit-content; margin: 10px auto;">LOUD</div>	<p>This key is used as the LOUD switching key.</p> <p>Each time the key is depressed, the LOUD output pin and the "LOU" display on the LCD panel reverse.</p> <p>While the "LOU" display on the LCD panel is lighted, a high output is produced at the LOUD pin, and when the display is extinguished the output becomes low.</p> <p>When first powered up (when V_{DD} rise), the "LOU" display is erased and a low output is produced at the LOUD pin.</p>

SYMBOL	DESCRIPTION
<div style="border: 1px solid black; padding: 2px; width: fit-content; margin: 0 auto;">DISP</div>	<p>This key switches the display. It is effective only in the RADIO mode.</p> <p>When this key is depressed, the time display is switched to frequency display or vice versa.</p> <p>However, Five seconds after this key is depressed, the display reverts to priority mode (according to the diode matrix PRIO).</p> <p>In no-clock status (CLKSEL = 0), this key is ineffective.</p>

Note 1: In this auto-tuning system, frequency changing is made after the PLL locking is checked. When the lock is released during auto-tuning the system waits without change until relocking occurs. At this time, it is possible for the alternate switch to be switched. However, it is not possible to activate the momentary key (RADIO OFF possible).

When the frequency changing is intended with the fear of unlocking during set adjustment, use the memory buttons (M1 to M6), or the

MAN UP

,

MAN DWN

 keys. Even if the lock is released, the PLL data can be set.

Note 2: During auto-tuning, if the band is switched and once again the original band is accessed, or if the power is turned OFF and then ON again, the very last station received is accessed.

2. DISPLAY

2.1 LCD PANEL

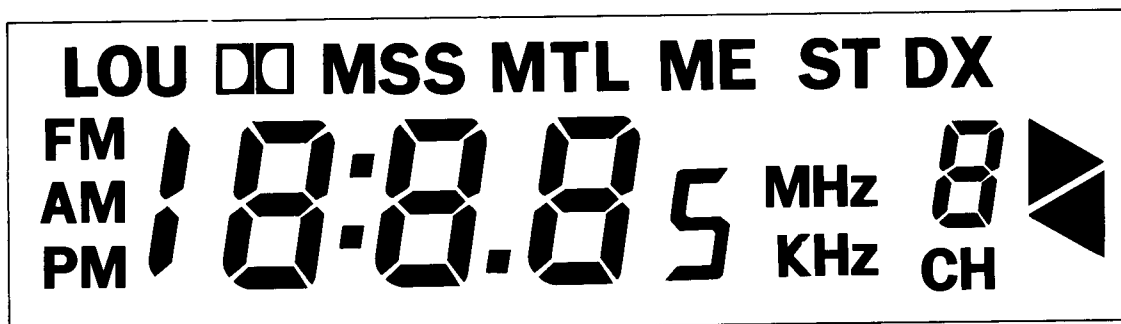

2.2 CHARACTER FORMS





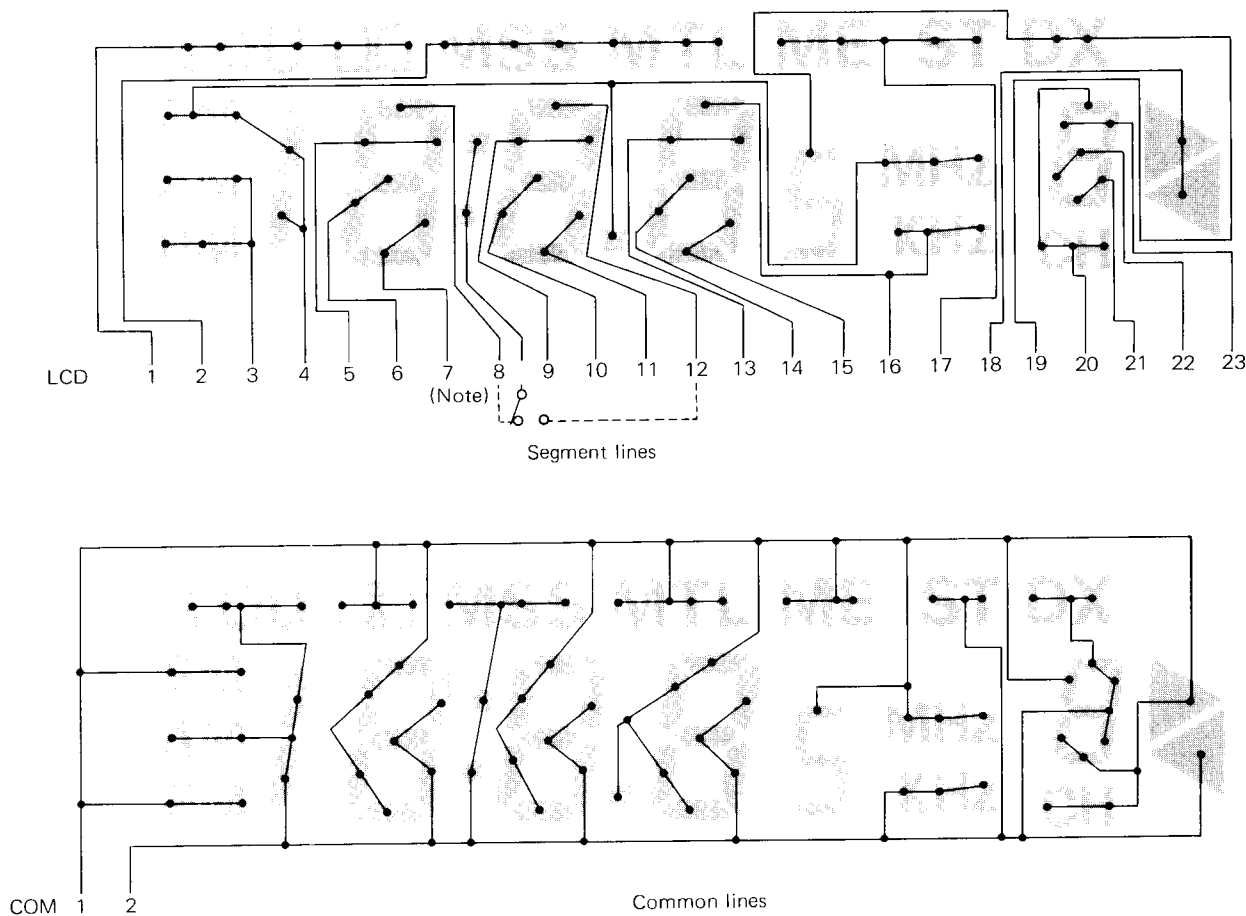

2.3 LCD PATTERN



Note: For the colon ":" to blink during the clock display, connect to LCD8; for continuous lighting, connect to LCD12.

2.4 DISPLAY DESCRIPTION

DISPLAY	DESCRIPTION
LOU	This display indicates LOUDNESS mode status.
 NR	This display indicates Dolby NR mode status. Lights only in TAPE mode.
MSS	This display indicates MSS mode status. Lights only in TAPE mode.
MTL	This display indicates METAL mode status. Lights only in TAPE mode.
ME	Lights during preset memory write-in possible status.
ST	This display indicates that a STEREO signal is being input. It is lighted when the key matrix ST is OFF. However, even if the ST switch is OFF, this display is extinguished when the clock is displayed and during auto-tuning (AF MUTE pin active).
DX	This display is only lighted in RADIO mode when the auto-tuning reception gain is at DX level.
FM (Decimal point) MHz	In the FM band, lights during the frequency display.
AM	In the AM band, lights during the frequency display and in the clock display during the morning.
kHz	In the AM band, lights during the frequency display.
PM	This display indicates afternoon during the clock display.
	This display indicates the direction in which the tape is running. When REW in the key matrix is ON, "◀" is displayed. When F/F is ON, "▶" is displayed.
	During preset memory display the preset channel number is lighted.
	The (5) in the last column is used only with the FM band in the South Africa territory. In other territories, the first four columns only are displayed, for both AM and FM. The clock is also displayed in the first four columns.
: (colon)	Lights when the clock is displayed. Can be lighted continuously, or blinking. However, in this case the wiring of the segments differs so care must be taken.

2.5 LCD DRIVE WAVEFORM

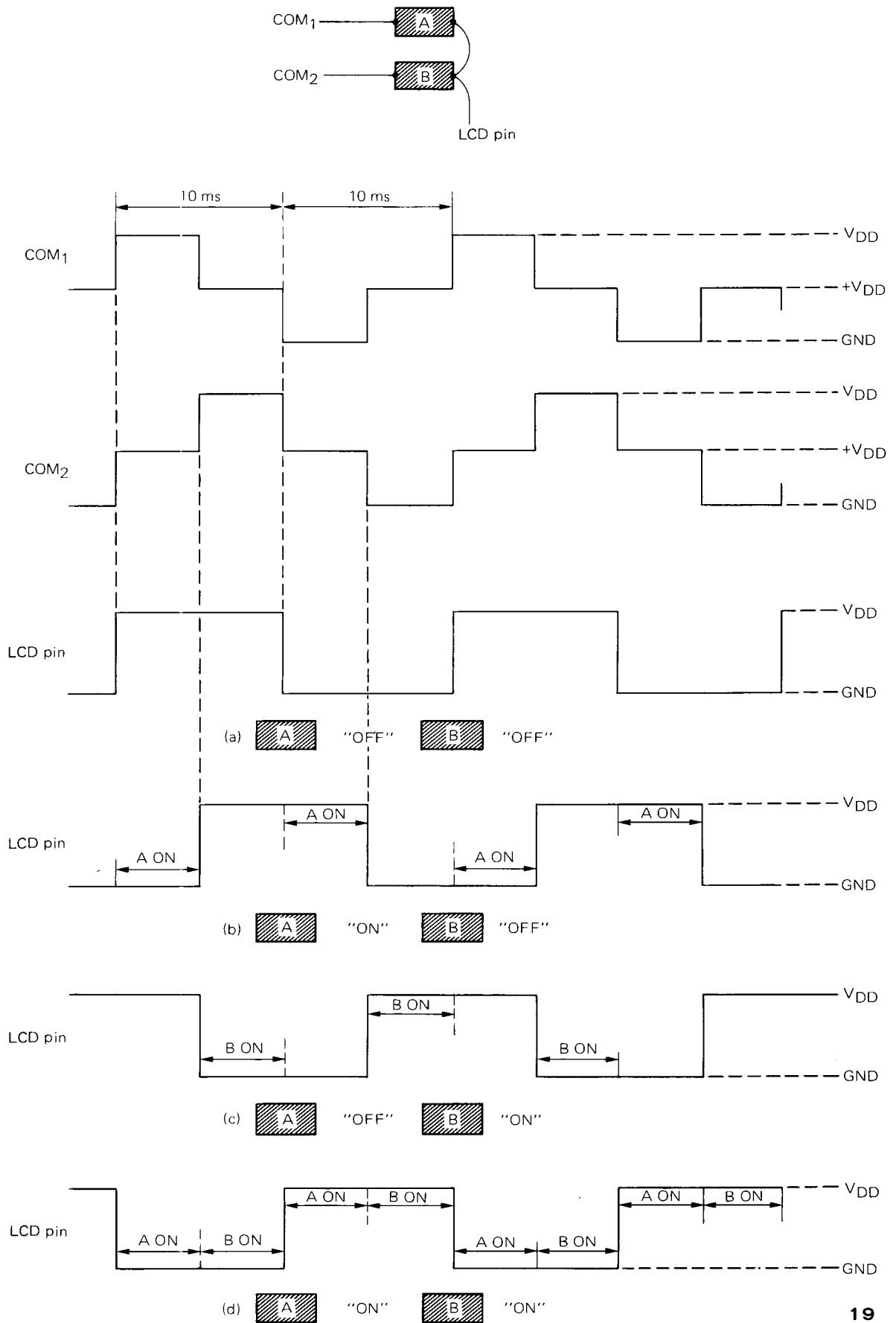

3. TIMING CHARTS

AF-MUTE Output Timing Chart

- ① Key ON chattering prevention time
- ② MUTE leading time
- ③ Setting of division ratio and renewing of display contents
- ④ MUTE trailing time
- ⑤ SCAN time
- ⑥ PLL lock time

(1) Manual UP/DOWN

(i) When the key is released within 0.5 seconds (outside of band edge)

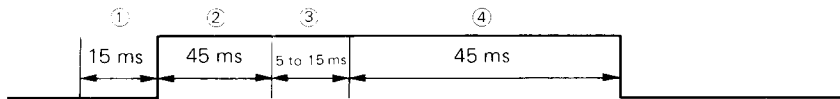

(ii) When the key is released within 0.5 seconds (band edge: highest frequency \rightleftharpoons lowest frequency)

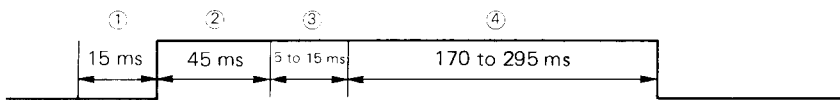

(iii) When the key is continuously depressed for more than 0.5 seconds

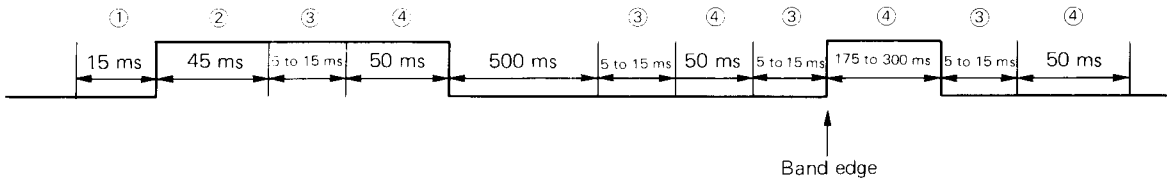

(2) Auto UP/DOWN (SCAN/SEEK)

(i) When SD signal is present

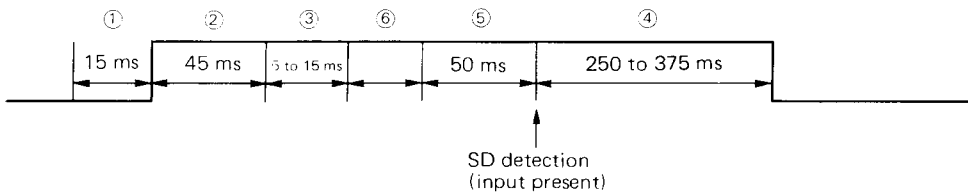

(ii) When SD signal is absent

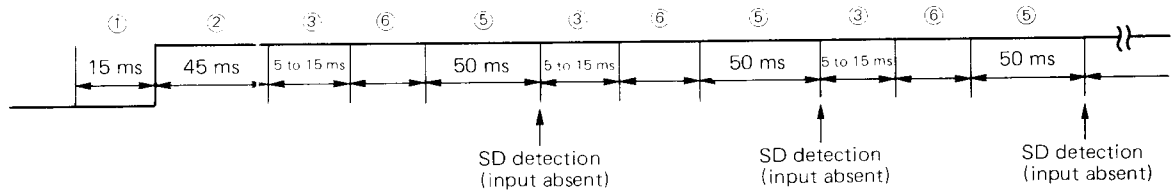

However, when the band edge is reached (highest frequency \rightleftharpoons lowest frequency), the time under ⑤ becomes 175 to 300 ms.

(3) Preset memory access

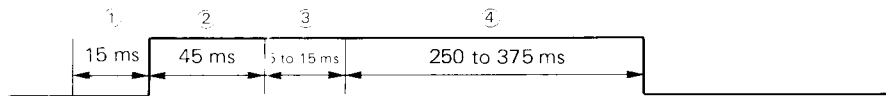

(4) Band switching



(5) MODE Switching (RADIO \rightarrow TAPE), CE pin: Low \rightarrow High

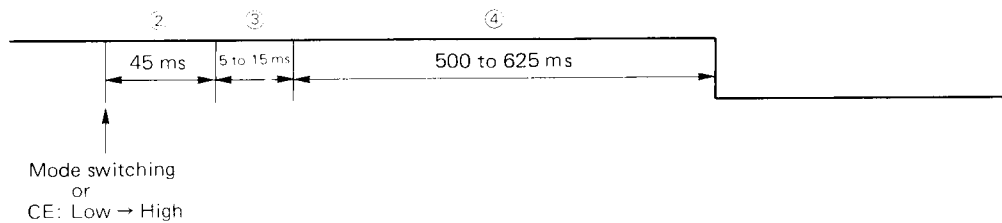

(6) MODE Switching (TAPE \rightarrow RADIO), CE pin: Low \rightarrow High

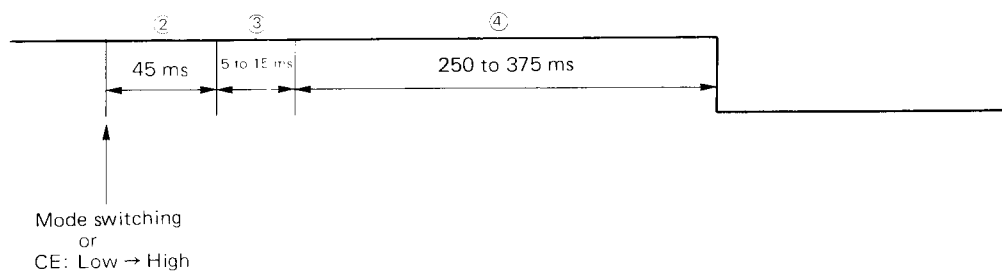

4. FM BAND FREQUENCY TABLE FOR SOUTH AFRICA

CHANNEL PLAN FREQUENCY	DISPLAY FREQUENCY	RECEIVING FREQUENCY	DIFFERENCE
87.604 MHz	87.6 MHz	87.60 MHz	-4 kHz
87.690	87.65	87.69	0
87.776	87.75	87.78	4
87.862	87.85	87.86	-2
87.948	87.9	87.95	2
88.034	88.0	88.03	-4
88.120	88.1	88.12	0
88.206	88.2	88.21	4
88.292	88.25	88.29	-2
88.378	88.35	88.38	2
88.464	88.45	88.46	-4
88.550	88.55	88.55	0
88.636	88.6	88.64	4
88.722	88.7	88.72	-2
88.808	88.8	88.81	2
88.894	88.85	88.89	-4
88.980	88.95	88.98	0
89.066	89.05	89.07	4
89.152	89.15	89.15	-2
89.238	89.2	89.24	2
89.324	89.3	89.32	-4
89.410	89.4	89.41	0
89.496	89.45	89.50	4
89.582	89.55	89.58	-2
89.668	89.65	89.67	2
89.754	89.75	89.75	-4
89.840	89.8	89.84	0
89.926	89.9	89.93	4
90.012	90.0	90.01	-2
90.098	90.05	90.10	2
90.184	90.15	90.18	-4
90.270	90.25	90.27	0
90.356	90.35	90.36	4
90.442	90.4	90.44	-2
90.528	90.5	90.53	2
90.614	90.6	90.61	-4
90.700	90.7	90.70	0
90.786	90.75	90.79	4
90.872	90.85	90.87	-2
90.958	90.95	90.96	2
91.044	91.0	91.04	-4
91.130	91.1	91.13	0
91.216	91.2	91.22	4
91.302	91.3	91.30	-2
91.388	91.35	91.39	2
91.474	91.45	91.47	-4
91.560	91.55	91.56	0
91.646	91.6	91.65	4
91.732	91.7	91.73	-2
91.818	91.8	91.82	2

CHANNEL PLAN FREQUENCY	DISPLAY FREQUENCY	RECEIVING FREQUENCY	DIFFERENCE
91.904 MHz	91.9 MHz	91.90 MHz	-4 kHz
91.990	91.95	91.99	0
92.076	92.05	92.08	4
92.162	92.15	92.16	-2
92.248	92.2	92.25	2
92.334	92.3	92.33	-4
92.420	92.4	92.42	0
92.506	92.5	92.51	4
92.592	92.55	92.59	-2
92.678	92.65	92.68	2
92.764	92.75	92.76	-4
92.850	92.85	92.85	0
92.936	92.9	92.94	4
93.022	93.0	93.02	-2
93.108	93.1	93.11	2
93.194	93.15	93.19	-4
93.280	93.25	93.28	0
93.366	93.35	93.37	4
93.452	93.45	93.45	-2
93.538	93.5	93.54	2
93.624	93.6	93.62	-4
93.710	93.7	93.71	0
93.796	93.75	93.80	4
93.882	93.85	93.88	-2
93.968	93.95	93.97	2
94.054	94.05	94.05	-4
94.140	94.1	94.14	0
94.226	94.2	94.23	4
94.312	94.3	94.31	-2
94.398	94.35	94.40	2
94.484	94.45	94.48	-4
94.570	94.55	94.57	0
94.656	94.65	94.66	4
94.742	94.7	94.74	-2
94.828	94.8	94.83	2
94.914	94.9	94.91	-4
95.000	95.0	95.00	0
95.086	95.05	95.09	4
95.172	95.15	95.17	-2
95.258	95.25	95.26	2
95.344	95.3	95.34	-4
95.430	95.4	95.43	0
95.516	95.5	95.52	4
95.602	95.6	95.60	-2
95.688	95.65	95.69	2
95.774	95.75	95.77	-4
95.860	95.85	95.86	0
95.946	95.9	95.95	4
96.032	96.0	96.03	-2
96.118	96.1	96.12	2

CHANNEL PLAN FREQUENCY	DISPLAY FREQUENCY	RECEIVING FREQUENCY	DIFFERENCE
96.204 MHz	96.2 MHz	96.20 MHz	-4 kHz
96.290	96.25	96.29	0
96.376	96.35	96.38	4
96.462	96.45	96.46	-2
96.548	96.5	96.55	2
96.634	96.6	96.63	-4
96.720	96.7	96.72	0
96.806	96.8	96.81	4
96.892	96.85	96.89	-2
96.978	96.95	96.98	2
97.064	97.05	97.06	-4
97.150	97.15	97.15	0
97.236	97.2	97.24	4
97.322	97.3	97.32	-2
97.408	97.4	97.41	2
97.494	97.45	97.49	-4
97.580	97.55	97.58	0
97.666	97.65	97.67	4
97.752	97.75	97.75	-2
97.838	97.8	97.84	2
97.924	97.9	97.92	-4
98.010	98.0	98.01	0
98.096	98.05	98.10	4
98.182	98.15	98.18	-2
98.268	98.25	98.27	2
98.354	98.35	98.35	-4
98.440	98.4	98.44	0
98.526	98.5	98.53	4
98.612	98.6	98.61	-2
98.698	98.65	98.70	2
98.784	98.75	98.78	-4
98.870	98.85	98.87	0
98.956	98.95	98.96	4
99.042	99.0	99.04	-2
99.128	99.1	99.13	2
99.214	99.2	99.21	-4
99.300	99.3	99.30	0
99.386	99.35	99.39	4
99.472	99.45	99.47	-2
99.558	99.55	99.56	2
99.644	99.6	99.64	-4
99.730	99.7	99.73	0
99.816	99.8	99.82	4
99.902	99.9	99.90	-2
99.988	99.95	99.99	2
100.074	100.05	100.07	-4
100.160	100.15	100.16	0
100.246	100.2	100.25	4
100.332	100.3	100.33	-2
100.418	100.4	100.42	2

CHANNEL PLAN FREQUENCY	DISPLAY FREQUENCY	RECEIVING FREQUENCY	DIFFERENCE
100.504 MHz	100.5 MHz	100.50 MHz	-4 kHz
100.590	100.55	100.59	0
100.676	100.65	100.68	4
100.762	100.75	100.76	-2
100.848	100.8	100.85	2
100.934	100.9	100.93	-4
101.020	101.0	101.02	0
101.106	101.1	101.11	4
101.192	101.15	101.19	-2
101.278	101.25	101.28	2
101.364	101.35	101.36	-4
101.450	101.45	101.45	0
101.536	101.5	101.54	4
101.622	101.6	101.62	-2
101.708	101.7	101.71	2
101.794	101.75	101.79	-4
101.880	101.85	101.88	0
101.966	101.95	101.97	4
102.052	102.05	102.05	-2
102.138	102.1	102.14	2
102.224	102.2	102.22	-4
102.310	102.3	102.31	0
102.396	102.35	102.40	4
102.482	102.45	102.48	-2
102.568	102.55	102.57	2
102.654	102.65	102.65	-4
102.740	102.7	102.74	0
102.826	102.8	102.83	4
102.912	102.9	102.91	-2
102.998	102.95	103.00	2
103.084	103.05	103.08	-4
103.170	103.15	103.17	0
103.256	103.25	103.26	4
103.342	103.3	103.34	-2
103.428	103.4	103.43	2
103.514	103.5	103.51	-4
103.600	103.6	103.60	0
103.686	103.65	103.69	4
103.772	103.75	103.77	-2
103.858	103.85	103.86	2
103.944	103.9	103.94	-4
104.030	104.0	104.03	0
104.116	104.1	104.12	4
104.202	104.2	104.20	-2
104.288	104.25	104.29	2
104.374	104.35	104.37	-4
104.460	104.45	104.46	0
104.546	104.5	104.55	4
104.632	104.6	104.63	-2
104.718	104.7	104.72	2

CHANNEL PLAN FREQUENCY	DISPLAY FREQUENCY	RECEIVING FREQUENCY	DIFFERENCE
104.804 MHz	104.8 MHz	104.80 MHz	-4 kHz
104.890	104.85	104.89	0
104.976	104.95	104.98	4
105.062	105.05	105.06	-2
105.148	105.1	105.15	2
105.234	105.2	105.23	-4
105.320	105.3	105.32	0
105.406	105.4	105.41	4
105.492	105.45	105.49	-2
105.578	105.55	105.58	2
105.664	105.65	105.66	-4
105.750	105.75	105.75	0
105.836	105.8	105.84	4
105.922	105.9	105.92	-2
106.008	106.0	106.01	2
106.094	106.05	106.09	-4
106.180	106.15	106.18	0
106.266	106.25	106.27	4
106.352	106.35	106.35	-2
106.438	106.4	106.44	2
106.524	106.5	106.52	-4
106.610	106.6	106.61	0
106.696	106.65	106.70	4
106.782	106.75	106.78	-2
106.868	106.85	106.87	2
106.954	106.95	106.95	-4
107.040	107.0	107.04	0
107.126	107.1	107.13	4
107.212	107.2	107.21	-2
107.298	107.25	107.30	2
107.384	107.35	107.38	-4
107.470	107.45	107.47	0
107.556	107.55	107.56	4
107.642	107.6	107.64	-2
107.728	107.7	107.73	2
107.814	107.8	107.81	-4
107.900	107.9	107.90	0

5. APPLICATION CIRCUIT (RADIO power control is available using the momentary key.)

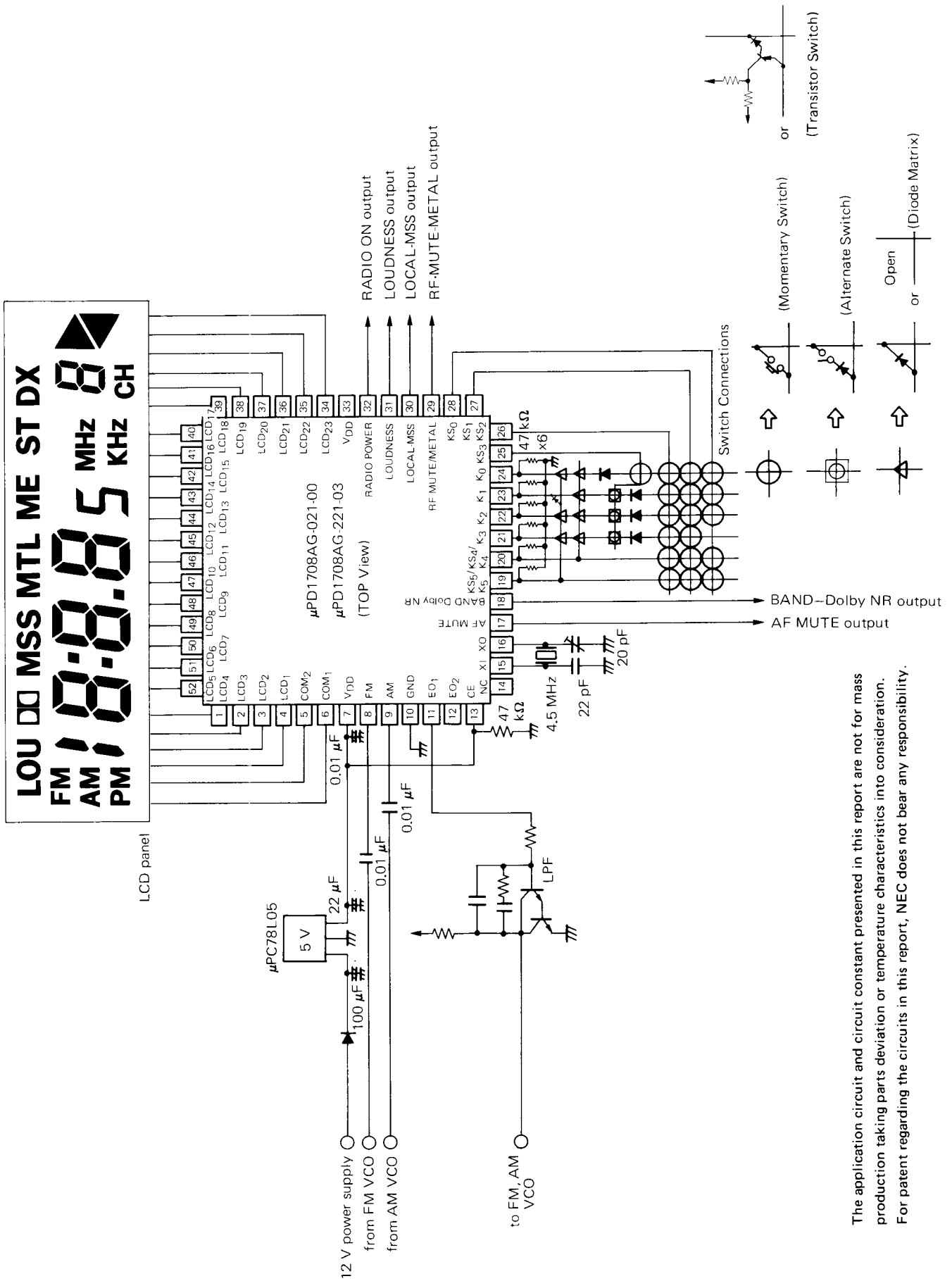

The application circuit and circuit constant presented in this report are not for mass production taking parts deviation or temperature characteristics into consideration. For patent regarding the circuits in this report, NEC does not bear any responsibility.

6. ELECTRICAL CHARACTERISTICS

6.1 ABSOLUTE MAXIMUM RATINGS

Supply Voltage	V_{DD}	-0.3 to +6.0	V
Input Voltage	V_I	-0.3 to $+V_{DD}+0.3$	V
Output Voltage	V_O	-0.3 to $+V_{DD}+0.3$	V
Output Sink Current	I_O	10	mA
Operating Temperature	T_{opt}	-40 to +85	°C
Storage Temperature	T_{stg}	-55 to +125	°C

6.2 RECOMMENDED OPERATING CONDITIONS

CHARACTERISTIC	SYMBOL	MIN.	TYP.	MAX.	UNIT	CONDITION
Supply Voltage	V_{DD}	4.5	5.0	5.5	V	
Temperature	T_a	-40		+85	°C	
Input Oscillation Voltage	V_{in1}	0.3		4.5	V_{p-p}	AM pin
Input Oscillation Voltage	V_{in2}	0.5		4.5	V_{p-p}	FM pin

6.3 DC CHARACTERISTICS ($V_{DD} = +4.5$ to $+5.5$ V, $T_a = -40$ to $+85$ °C)

CHARACTERISTIC	SYMBOL	MIN.	TYP.	MAX.	UNIT	CONDITION
Supply Voltage	V_{DD1}	4.5	5.0	5.5	V	CPU and PLL operation
Supply Voltage	V_{DD2}	3.5		5.5	V	CPU operation only (when clock is operated only)
Supply Current	I_{DD1}		15		mA	When 120 MHz is input from FM pin $V_{DD}=5$ V, $T_a=25$ °C
Supply Current	I_{DD2}		400		μ A	CPU operation only (when clock operation) $V_{DD}=5$ V, $T_a=25$ °C
Supply Current	I_{DD3}		1	10	μ A	CE pin=Low (when no clock mode)
High Level Output Current	I_{OH1}	-1.0	-2.5		mA	AF MUTE, BAND Dolby NR, \overline{DX} / MSS. RF MUTE/METAL, KS_0 to KS_5 , EO_1 , EO_2 pins $V_{OH}=V_{DD}-1$ V
High Level Output Current	I_{OH2}	-10	-18		μ A	LCD ₁ to LCD ₂₃ pins $V_{OH}=V_{DD}-1$ V
High Level Output Current	I_{OH3}	-20	-60		μ A	COM ₁ , COM ₂ pins $V_{OH}=V_{DD}-1$ V
Low Level Output Current	I_{OL1}	1.0	3.8		mA	AF MUTE, BAND/Dolby NR, LOUDNESS, RADIO POWER, EO_1 , EO_2 pins $V_{OL}=1$ V
Low Level Output Current	I_{OL2}	25	100		μ A	KS_0 to KS_5 , DX/MSS, RF-MUTE/ METAL pins $V_{OL}=1$ V
Low Level Output Current	I_{OL3}	10	30		μ A	LCD ₁ to LCD ₂₃ pins $V_{OL}=1$ V
Low Level Output Current	I_{OL4}	20	80		μ A	COM ₁ , COM ₂ pins $V_{OL}=1$ V
High Level Input Current	I_{IH1}	10	35	60	μ A	K_0 to K_3 pins $V_{IH}=V_{DD}=5$ V
High Level Input Current	I_{IH2}	100	300		μ A	FM pin, AM pin, X1 pin $V_{IH}=V_{DD}=5$ V
Output Leakage Current	I_L	-1		+1	μ A	EO_1 , EO_2 pins $V_{DD}=V_{OL}=5$ V, $V_{OH}=0$ V
High Level Input Voltage	V_{IH1}	$0.7 V_{DD}$			V	K_4 , K_5 pins
High Level Input Voltage	V_{IH2}	$0.6 V_{DD}$			V	K_0 to K_3 pins
High Level Input Voltage	V_{IH3}	$0.8 V_{DD}$			V	CE pin
Low Level Input Voltage	V_{IL1}			$0.3 V_{DD}$	V	K_4 , K_5 pins
Low Level Input Voltage	V_{IL2}			$0.2 V_{DD}$	V	K_0 to K_3 pins
Low Level Input Voltage	V_{IL3}			$0.2 V_{DD}$	V	CE pin
Output Voltage	V_O	2.3		2.8	V	COM ₁ , COM ₂ pins 1/2 bias voltage $V_{DD}=5$ V

6.4 AC CHARACTERISTICS ($V_{DD} = +4.5$ to $+5.5$ V, $T_a = -40$ to $+85$ °C)

CHARACTERISTIC	SYMBOL	MIN.	TYP.	MAX.	UNIT	CONDITION
Operating Frequency	f_{in1}	0.5		20	MHz	AM pin $V_i=0.1$ V _{p-p} $V_{DD}=4.5$ V
Operating Frequency	f_{in2}	10		130	MHz	FM pin $V_i=0.3$ V _{p-p} $V_{DD}=4.5$ V
Operating Frequency	f_{in3}	10		150	MHz	FM pin $V_i=0.5$ V _{p-p} $V_{DD}=4.5$ V

7. PACKAGE DIMENSIONS (Unit: mm)

μ PD1708AG-021-00 (Lead bended type)

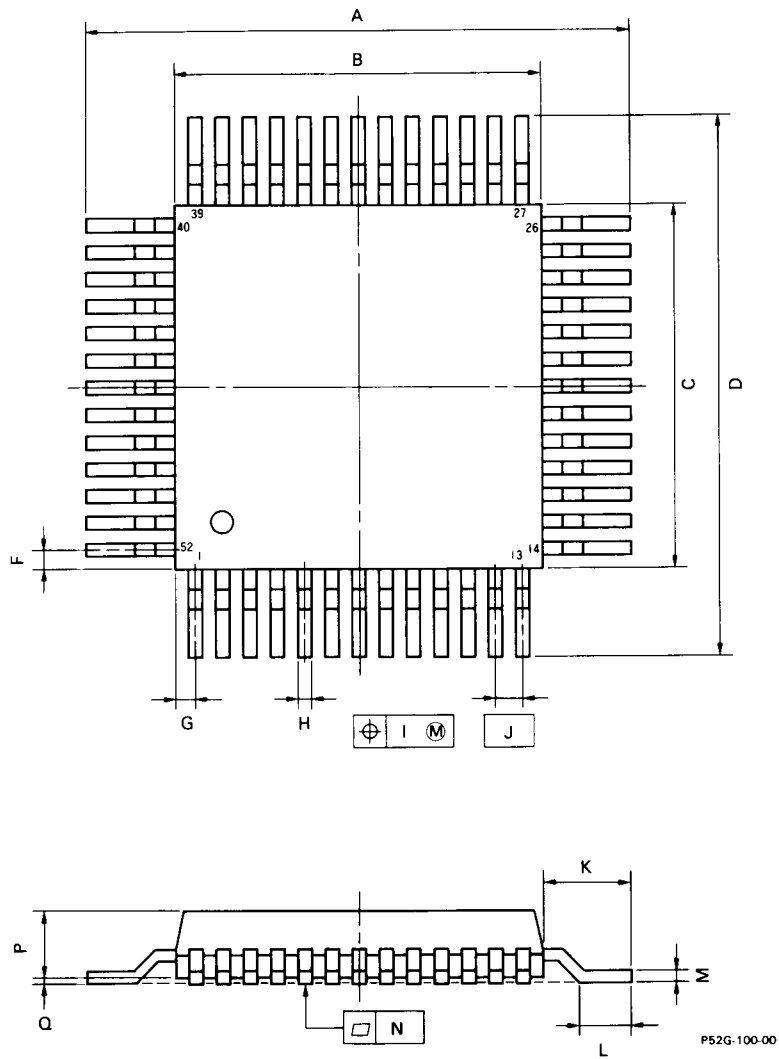

NOTE

Each lead centerline is located within 0.20 mm (0.008 inch) of its true position (T.P.) at maximum material condition.

ITEM	MILLIMETERS	INCHES
A	21.0 ^{-0.4}	0.827 ^{+0.016}
B	14.0 ^{-0.2}	0.551 ^{-0.008}
C	14.0 ^{-0.2}	0.551 ^{-0.008}
D	21.0 ^{-0.4}	0.827 ^{+0.016}
F	1.0	0.039
G	1.0	0.039
H	0.40 ^{-0.10}	0.016 ^{-0.004}
I	0.20	0.008
J	1.0 (T.P.)	0.039 (T.P.)
K	3.5 ^{-0.2}	0.138 ^{-0.008}
L	2.2 ^{-0.2}	0.087 ^{-0.008}
M	0.15 ^{-0.06}	0.006 ^{-0.002}
N	0.15	0.006
P	2.6 ^{-0.2}	0.102 ^{-0.008}
Q	0.1 ^{-0.1}	0.004 ^{-0.004}

μPD1708AG-221-03 (Straight lead type)

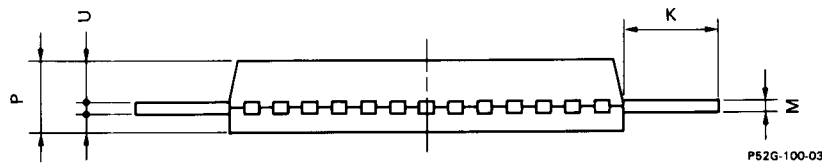
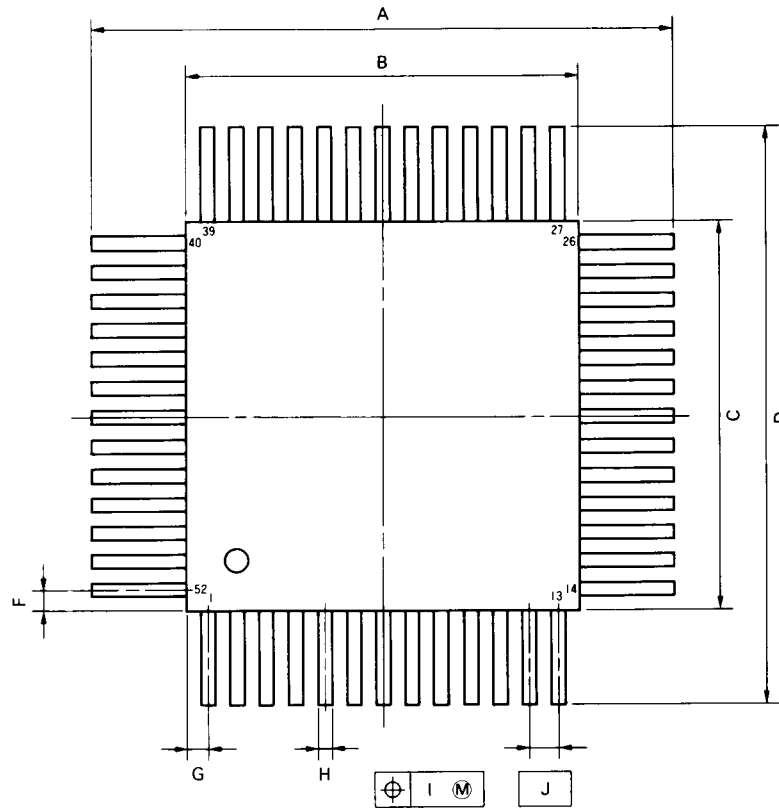

P52G-100-03

NOTE
Each lead centerline is located within 0.20 mm (0.008 inch) of its true position (T.P.) at maximum material condition.

ITEM	MILLIMETERS	INCHES
A	19.8 ^{+0.4}	0.780 ^{+0.015}
B	14 ^{+0.2}	0.551 ^{+0.008}
C	14 ^{+0.2}	0.551 ^{+0.008}
D	19.8 ^{+0.4}	0.780 ^{+0.015}
F	1.0	0.039
G	1.0	0.039
H	0.40 ^{+0.10}	0.016 ^{+0.004}
I	0.20	0.008
J	1.0 (T.P.)	0.039 (T.P.)
K	2.9 ^{+0.2}	0.114 ^{+0.008}
M	0.15 ^{+0.05}	0.006 ^{+0.001}
P	2.6 ^{+0.2}	0.102 ^{+0.008}
T	1.0	0.039
U	1.45	0.057

For values with no particular specification, typical values are shown.