

Preliminary User's Manual

NEC

www.DataSheet4U.com
VR4102™

64/32-bit Microprocessor

μPD30102

Document No. U12739EJ2V0UM00 (2nd edition)

Date Published January 1998 N CP(K)

© NEC Corporation 1997

© MIPS Technologies, Inc. 1996

Printed in Japan

www.DataSheet4U.com

[MEMO]

NOTES FOR CMOS DEVICES

① PRECAUTION AGAINST ESD FOR SEMICONDUCTORS

Note:

Strong electric field, when exposed to a MOS device, can cause destruction of the gate oxide and ultimately degrade the device operation. Steps must be taken to stop generation of static electricity as much as possible, and quickly dissipate it once, when it has occurred. Environmental control must be adequate. When it is dry, humidifier should be used. It is recommended to avoid using insulators that easily build static electricity. Semiconductor devices must be stored and transported in an anti-static container, static shielding bag or conductive material. All test and measurement tools including work bench and floor should be grounded. The operator should be grounded using wrist strap. Semiconductor devices must not be touched with bare hands. Similar precautions need to be taken for PW boards with semiconductor devices on it.

② HANDLING OF UNUSED INPUT PINS FOR CMOS

Note:

No connection for CMOS device inputs can be cause of malfunction. If no connection is provided to the input pins, it is possible that an internal input level may be generated due to noise, etc., hence causing malfunction. CMOS devices behave differently than Bipolar or NMOS devices. Input levels of CMOS devices must be fixed high or low by using a pull-up or pull-down circuitry. Each unused pin should be connected to V_{DD} or GND with a resistor, if it is considered to have a possibility of being an output pin. All handling related to the unused pins must be judged device by device and related specifications governing the devices.

③ STATUS BEFORE INITIALIZATION OF MOS DEVICES

Note:

Power-on does not necessarily define initial status of MOS device. Production process of MOS does not define the initial operation status of the device. Immediately after the power source is turned ON, the devices with reset function have not yet been initialized. Hence, power-on does not guarantee out-pin levels, I/O settings or contents of registers. Device is not initialized until the reset signal is received. Reset operation must be executed immediately after power-on for devices having reset function.

VR3000, VR4000, VR4100, VR4101, VR4102, VR4200, VR4400, and VR Series are trademarks of NEC Corporation.

MIPS is a trademark of MIPS Technologies, Inc.

iAPX is a trademark of Intel Corp.

DEC VAX is a trademark of Digital Equipment Corp.

UNIX is a registered trademark in the United States and other countries, licensed exclusively through X/Open Company, Ltd.

Exporting this product or equipment that include this product may require a governmental license from the U.S.A. for some countries because this product utilizes technologies limited by the export control regulations of the U.S.A.

The information in this document is subject to change without notice.

No part of this document may be copied or reproduced in any form or by any means without the prior written consent of NEC Corporation. NEC Corporation assumes no responsibility for any errors which may appear in this document.

NEC Corporation does not assume any liability for infringement of patents, copyrights or other intellectual property rights of third parties by or arising from use of a device described herein or any other liability arising from use of such device. No license, either express, implied or otherwise, is granted under any patents, copyrights or other intellectual property rights of NEC Corporation or others.

While NEC Corporation has been making continuous effort to enhance the reliability of its semiconductor devices, the possibility of defects cannot be eliminated entirely. To minimize risks of damage or injury to persons or property arising from a defect in an NEC semiconductor device, customers must incorporate sufficient safety measures in its design, such as redundancy, fire-containment, and anti-failure features.

NEC devices are classified into the following three quality grades:

"Standard", "Special", and "Specific". The Specific quality grade applies only to devices developed based on a customer designated "quality assurance program" for a specific application. The recommended applications of a device depend on its quality grade, as indicated below. Customers must check the quality grade of each device before using it in a particular application.

Standard: Computers, office equipment, communications equipment, test and measurement equipment, audio and visual equipment, home electronic appliances, machine tools, personal electronic equipment and industrial robots

Special: Transportation equipment (automobiles, trains, ships, etc.), traffic control systems, anti-disaster systems, anti-crime systems, safety equipment and medical equipment (not specifically designed for life support)

Specific: Aircrafts, aerospace equipment, submersible repeaters, nuclear reactor control systems, life support systems or medical equipment for life support, etc.

The quality grade of NEC devices is "Standard" unless otherwise specified in NEC's Data Sheets or Data Books. If customers intend to use NEC devices for applications other than those specified for Standard quality grade, they should contact an NEC sales representative in advance.

Anti-radioactive design is not implemented in this product.

M7 96.5

Regional Information

Some information contained in this document may vary from country to country. Before using any NEC product in your application, please contact the NEC office in your country to obtain a list of authorized representatives and distributors. They will verify:

- Device availability
- Ordering information
- Product release schedule
- Availability of related technical literature
- Development environment specifications (for example, specifications for third-party tools and components, host computers, power plugs, AC supply voltages, and so forth)
- Network requirements

In addition, trademarks, registered trademarks, export restrictions, and other legal issues may also vary from country to country.

NEC Electronics Inc. (U.S.)

Santa Clara, California
Tel: 408-588-6000
800-366-9782
Fax: 408-588-6130
800-729-9288

NEC Electronics (Germany) GmbH

Duesseldorf, Germany
Tel: 0211-65 03 02
Fax: 0211-65 03 490

NEC Electronics (UK) Ltd.

Milton Keynes, UK
Tel: 01908-691-133
Fax: 01908-670-290

NEC Electronics Italiana s.r.l.

Milano, Italy
Tel: 02-66 75 41
Fax: 02-66 75 42 99

NEC Electronics (Germany) GmbH

Benelux Office
Eindhoven, The Netherlands
Tel: 040-2445845
Fax: 040-2444580

NEC Electronics (France) S.A.

Velizy-Villacoublay, France
Tel: 01-30-67 58 00
Fax: 01-30-67 58 99

NEC Electronics (France) S.A.

Spain Office
Madrid, Spain
Tel: 01-504-2787
Fax: 01-504-2860

NEC Electronics (Germany) GmbH

Scandinavia Office
Taeby, Sweden
Tel: 08-63 80 820
Fax: 08-63 80 388

NEC Electronics Hong Kong Ltd.

Hong Kong
Tel: 2886-9318
Fax: 2886-9022/9044

NEC Electronics Hong Kong Ltd.

Seoul Branch
Seoul, Korea
Tel: 02-528-0303
Fax: 02-528-4411

NEC Electronics Singapore Pte. Ltd.

United Square, Singapore 1130
Tel: 253-8311
Fax: 250-3583

NEC Electronics Taiwan Ltd.

Taipei, Taiwan
Tel: 02-719-2377
Fax: 02-719-5951

NEC do Brasil S.A.

Cumbica-Guarulhos-SP, Brasil
Tel: 011-6465-6810
Fax: 011-6465-6829

J97. 8

[MEMO]

PREFACE

Readers This manual targets users who intend to understand the functions of the VR4102 and to design application systems using this microprocessor.

Purpose This manual introduces the architecture and hardware functions of the VR4102 to users, following the organization described below.

Organization This manual consists of the following contents:

- Introduction
- Pipeline operation
- Cache organization and memory management system
- Exception processing
- Initialization interface
- Interrupts
- Peripheral units
- Instruction set details

How to read this manual It is assumed that the reader of this manual has general knowledge in the fields of electric engineering, logic circuits, and microcomputers.

The VR4000™ in this manual includes the VR4400™.

To learn in detail about the function of a specific instruction,

→ Read **Chapter 3 CPU Instruction Set Summary** and **Chapter 27 CPU Instruction Set Details**.

To learn about the overall functions of the VR4102,

→ Read this manual in sequential order.

To learn about electrical specifications,

→ Refer to **Data Sheet** which is separately available.

Legend

Data significance: Higher on left and lower on right

Active low: XXX# (trailing # after pin and signal names)

Numeric representation: binary/decimal ... XXXX

hexadecimal ... 0XXXXX

Prefixes representing an exponent of 2 (for address space or memory capacity):

K (kilo) $2^{10} = 1024$

M (mega) $2^{20} = 1024^2$

G (giga) $2^{30} = 1024^3$

T (tera) $2^{40} = 1024^4$

P (peta) $2^{50} = 1024^5$

E (exa) $2^{60} = 1024^6$

Related Documents

The related documents indicated here may include preliminary version. However, preliminary versions are not marked as such.

- User's manual
 - VR4102 User's Manual This manual
 - VR4100™ User's Manual U10050E
- Data sheet
 - VR4102 Data Sheet U12543E
- Application note
 - VR4102 Application Note To be prepared
 - VR Series™ Application Note programming guide U10710J^{Note}

Note This document number is that of the Japanese version.

CONTENTS

CHAPTER 1 INTRODUCTION	29
1.1 FEATURES	29
1.2 ORDERING INFORMATION	30
1.3 64-BIT ARCHITECTURE	30
1.4 VR4102 PROCESSOR	30
1.4.1 Internal Block Structure.....	31
1.4.2 I/O Registers	33
1.5 VR4100 CPU CORE	43
1.5.1 VR4100 CPU Core	43
1.5.2 CPU Registers	45
1.5.3 CPU Instruction Set Overview.....	46
1.5.4 Data Formats and Addressing	47
1.5.5 Coprocessors (CP0-CP3).....	49
1.5.6 Floating-Point Unit (FPU).....	51
1.5.7 Cache	51
1.6 CPU CORE MEMORY MANAGEMENT SYSTEM (MMU)	52
1.6.1 Translation Lookaside Buffer (TLB)	52
1.6.2 Operating Modes.....	52
1.7 INSTRUCTION PIPELINE	53
1.8 CLOCK INTERFACE	53
CHAPTER 2 PIN FUNCTIONS	57
2.1 PIN CONFIGURATION	57
2.2 PIN FUNCTION DESCRIPTION	62
2.2.1 System Bus Interface Signals	63
2.2.2 Clock Interface Signals.....	65
2.2.3 Battery Monitor Interface Signals	65
2.2.4 Initialization Interface Signals.....	66
2.2.5 RS-232-C Interface Signals.....	67
2.2.6 IrDA Interface Signals.....	68
2.2.7 Debug Serial Interface Signals.....	68
2.2.8 Keyboard Interface Signals	69
2.2.9 Audio Interface Signals	69
2.2.10 Touch Panel/General Purpose A/D Interface Signals	69
2.2.11 General-purpose I/O Signals	70
2.2.12 HSP MODEM Interface Signals	71
2.2.13 LED Interface Signal	71
2.2.14 Dedicated V _{DD} and GND Signals	72
2.3 PIN STATUS UPON SPECIFIC STATES	73
2.3.1 Pin Status upon Reset	73
2.3.2 Connection of Unused Pins and Pin I/O Circuits	76
2.3.3 Pin I/O Circuits	79

CHAPTER 3 CPU INSTRUCTION SET SUMMARY	81
3.1 CPU INSTRUCTION FORMATS	81
3.2 INSTRUCTION CLASSES.....	82
3.2.1 Load and Store Instructions.....	82
3.2.2 Computational Instructions.....	86
3.2.3 Jump and Branch Instructions.....	92
3.2.4 Special Instructions	96
3.2.5 System Control Coprocessor (CP0) Instructions	97
CHAPTER 4 VR4102 PIPELINE	99
4.1 PIPELINE STAGES	99
4.1.1 Pipeline Activities.....	100
4.2 BRANCH DELAY.....	102
4.3 LOAD DELAY	102
4.4 PIPELINE OPERATION.....	102
4.5 INTERLOCK AND EXCEPTION HANDLING.....	109
4.5.1 Exception Conditions.....	112
4.5.2 Stall Conditions	113
4.5.3 Slip Conditions	114
4.5.4 Bypassing	115
4.6 CODE COMPATIBILITY.....	115
CHAPTER 5 MEMORY MANAGEMENT SYSTEM.....	117
5.1 TRANSLATION LOOKASIDE BUFFER (TLB).....	117
5.2 VIRTUAL ADDRESS SPACE.....	117
5.2.1 Virtual-to-Physical Address Translation	118
5.2.2 32-bit Mode Address Translation.....	119
5.2.3 64-bit Mode Address Translation.....	120
5.2.4 Operating Modes	121
5.2.5 User Mode Virtual Addressing	121
5.2.6 Supervisor-mode Virtual Addressing	124
5.2.7 Kernel-mode Virtual Addressing.....	127
5.3 PHYSICAL ADDRESS SPACE	135
5.3.1 ROM Space.....	137
5.3.2 System Bus Space	138
5.3.3 Internal I/O Space	139
5.3.4 LCD Space	140
5.3.5 DRAM Space	140
5.4 SYSTEM CONTROL COPROCESSOR	141
5.4.1 Format of a TLB Entry.....	142
5.5 CP0 REGISTERS.....	146
5.5.1 Index Register (0)	146
5.5.2 Random Register (1)	146
5.5.3 EntryHi (10), EntryLo0 (2), EntryLo1 (3), and PageMask (5) Registers.....	147
5.5.4 Wired Register (6).....	148

5.5.5	Processor Revision Identifier (PRId) Register (15)	149
5.5.6	Config Register (16)	150
5.5.7	Load Linked Address (LLAddr) Register (17)	151
5.5.8	Cache Tag Registers (TagLo (28) and TagHi (29))	152
5.5.9	Virtual-to-Physical Address Translation	153
5.5.10	TLB Misses	155
5.5.11	TLB Instructions	155
CHAPTER 6 EXCEPTION PROCESSING		157
6.1	HOW EXCEPTION PROCESSING WORKS	157
6.2	PRECISION OF EXCEPTIONS	158
6.3	EXCEPTION PROCESSING REGISTERS	159
6.3.1	Context Register (4)	160
6.3.2	BadVAddr Register (8)	161
6.3.3	Count Register (9)	161
6.3.4	Compare Register (11)	162
6.3.5	Status Register (12)	162
6.3.6	Cause Register (13)	165
6.3.7	Exception Program Counter (EPC) Register (14)	167
6.3.8	WatchLo (18) and WatchHi (19) Registers	168
6.3.9	XContext Register (20)	169
6.3.10	Parity Error Register (26)	170
6.3.11	Cache Error Register (27)	171
6.3.12	ErrorEPC Register (30)	171
6.4	DETAILS OF EXCEPTIONS	173
6.4.1	Exception Types	173
6.4.2	Exception Vector Locations	173
6.4.3	Priority of Exceptions	176
6.4.4	Cold Reset Exception	177
6.4.5	Soft Reset Exception	178
6.4.6	NMI Exception	179
6.4.7	Address Error Exception	180
6.4.8	TLB Exceptions	181
6.4.9	Cache Error Exception	184
6.4.10	Bus Error Exception	185
6.4.11	System Call Exception	186
6.4.12	Breakpoint Exception	186
6.4.13	Coprocessor Unusable Exception	187
6.4.14	Reserved Instruction Exception	188
6.4.15	Trap Exception	188
6.4.16	Integer Overflow Exception	189
6.4.17	Watch Exception	189
6.4.18	Interrupt Exception	190
6.5	EXCEPTION PROCESSING AND SERVICING FLOWCHARTS	191

CHAPTER 7	INITIALIZATION INTERFACE	199
7.1	RESET FUNCTION.....	199
7.1.1	RTC Reset	199
7.1.2	RSTSW	201
7.1.3	Deadman’s Switch.....	202
7.1.4	Software Shutdown.....	203
7.1.5	HALTimer Shutdown	204
7.2	POWERON SEQUENCE	205
7.3	RESET OF THE CPU CORE.....	207
7.3.1	Cold Reset.....	207
7.3.2	Soft Reset.....	208
7.4	VR4102 PROCESSOR MODES.....	210
7.4.1	Power Modes	210
7.4.2	Privilege Mode	211
7.4.3	Reverse Endian	211
7.4.4	Bootstrap Exception Vector (BEV)	211
7.4.5	Cache Error Check	212
7.4.6	Parity Error Prohibit	212
7.4.7	Interrupt Enable (IE).....	212
CHAPTER 8	CACHE MEMORY.....	213
8.1	MEMORY ORGANIZATION	213
8.2	CACHE ORGANIZATION.....	214
8.2.1	Organization of the Instruction Cache (I-Cache)	214
8.2.2	Organization of the Data Cache (D-Cache)	215
8.2.3	Accessing the Caches	216
8.3	CACHE OPERATIONS.....	217
8.3.1	Cache Write Policy	217
8.4	CACHE STATES	218
8.5	CACHE STATE TRANSITION DIAGRAMS.....	219
8.5.1	Data Cache State Transition.....	219
8.5.2	Instruction Cache State Transition	219
8.6	CACHE DATA INTEGRITY	220
8.7	MANIPULATION OF THE CACHES BY AN EXTERNAL AGENT.....	230
CHAPTER 9	CPU CORE INTERRUPTS.....	231
9.1	NON-MASKABLE INTERRUPT (NMI).....	231
9.2	ORDINARY INTERRUPTS	231
9.3	SOFTWARE INTERRUPTS GENERATED IN CPU CORE	232
9.4	TIMER INTERRUPT.....	232
9.5	ASSERTING INTERRUPTS	232
9.5.1	Detecting Hardware Interrupts	232
9.5.2	Masking Interrupt Signals.....	234

CHAPTER 10 BCU (BUS CONTROL UNIT)	235
10.1 GENERAL	235
10.2 REGISTER SET	235
10.2.1 BCUCNTREG 1 (0x0B00 0000)	236
10.2.2 BCUCNTREG 2 (0x0B00 0002)	238
10.2.3 BCUSPEEDREG (0x0B00 000A)	239
10.2.4 BCUERRSTREG (0x0B00 000C)	241
10.2.5 BCURFCNTREG (0x0B00 000E)	242
10.2.6 REVIDREG (0x0B00 0010).....	243
10.2.7 BCURFCOUNTREG (0x0B00 0012)	244
10.2.8 CLKSPEEDREG (0x0B00 0014)	245
10.3 CONNECTION OF ADDRESS PINS	246
10.4 NOTES ON USING BCU	247
10.4.1 CPU Core Bus Modes	247
10.4.2 Access Data Size.....	247
10.4.3 ROM Interface	248
10.4.4 Flash Memory Interface	249
10.4.5 LCD Control Interface	250
10.4.6 Illegal Access Notification.....	251
10.5 BUS OPERATIONS	252
10.5.1 ROM Access	252
10.5.2 System Bus Access	256
10.5.3 LCD Interface	263
10.5.4 DRAM Access (EDO Type)	264
10.5.5 Refresh.....	267
10.5.6 Bus Hold	268
CHAPTER 11 DMAAU (DMA ADDRESS UNIT)	271
11.1 GENERAL	271
11.2 REGISTER SET	272
11.2.1 AIU IN DMA Base Address Registers	273
11.2.2 AIU IN DMA Address Registers.....	275
11.2.3 AIU OUT DMA Base Address Registers	276
11.2.4 AIU OUT DMA Address Registers.....	278
11.2.5 FIR DMA Base Address Registers	279
11.2.6 FIR DMA Address Registers.....	280
CHAPTER 12 DCU (DMA CONTROL UNIT)	281
12.1 GENERAL	281
12.2 DMA PRIORITY CONTROL	281
12.3 REGISTER SET	281
12.3.1 DMARSTREG (0x0B00 0040)	282
12.3.2 DMAIDLEREG (0x0B00 0042)	283
12.3.3 DMASENREG (0x0B00 0044)	284
12.3.4 DMAMSKREG (0x0B00 0046)	285

12.3.5 DMAREQREG (0x0B00 0048).....	286
12.3.6 TDREG (0x0B00 004A)	287
CHAPTER 13 CMU (CLOCK MASK UNIT)	289
13.1 GENERAL.....	289
13.2 REGISTER SET	289
13.2.1 CMUCLKMSK (0x0B00 0060).....	290
CHAPTER 14 ICU (INTERRUPT CONTROL UNIT)	291
14.1 GENERAL.....	291
14.2 REGISTER SET	294
14.2.1 SYSINT1REG (0x0B00 0080).....	295
14.2.2 PIUINTREG (0x0B00 0082).....	297
14.2.3 AIUINTREG (0x0B00 0084).....	298
14.2.4 KIUINTREG (0x0B00 0086).....	299
14.2.5 GIUINTLREG (0x0B00 0088)	300
14.2.6 DSIUINTREG (0x0B00 008A).....	301
14.2.7 MSYSINT1REG (0x0B00 008C)	302
14.2.8 MPIUINTREG (0x0B00 008E).....	304
14.2.9 MAIUINTREG (0x0B00 0090).....	305
14.2.10 MKIUINTREG (0x0B00 0092).....	306
14.2.11 MGIUINTLREG (0x0B00 0094)	307
14.2.12 MDSIUINTREG (0x0B00 0096)	308
14.2.13 NMIREG (0x0B00 0098)	309
14.2.14 SOFTINTREG (0x0B00 009A).....	310
14.2.15 SYSINT2REG (0x0B00 0200).....	311
14.2.16 GIUINTHREG (0x0B00 0202).....	312
14.2.17 FIRINTREG (0x0B00 0204)	313
14.2.18 MSYSINT2REG (0x0B00 0206).....	314
14.2.19 MGIUINTHREG (0x0B00 0208).....	315
14.2.20 MFIRINTREG (0x0B00 020A).....	316
14.3 NOTES FOR REGISTER SETTING	317
CHAPTER 15 PMU (POWER MANAGEMENT UNIT)	319
15.1 GENERAL.....	319
15.1.1 Reset Control.....	319
15.1.2 Shutdown Control	320
15.1.3 Power-on Control	321
15.1.4 Power Mode	324
15.2 REGISTER SET	327
15.2.1 PMUINTREG (0x0B00 00A0)	328
15.2.2 PMUCNTREG (0x0B00 00A2).....	330
15.2.3 PMUINT2REG (0x0B00 00A4)	332
15.2.4 PMUCNT2REG (0x0B00 00A6).....	333

CHAPTER 16 RTC (REALTIME CLOCK UNIT)	335
16.1 GENERAL	335
16.2 REGISTER SET	336
16.2.1 Elapsed Time Registers.....	337
16.2.2 Elapsed Time Compare Registers	339
16.2.3 RTC Long 1 Registers.....	341
16.2.4 RTC Long 1 Count Registers	343
16.2.5 RTC Long 2 Registers.....	345
16.2.6 RTC Long 2 Count Registers	347
16.2.7 TClock Counter Registers	349
16.2.8 TClock Counter Count Registers.....	351
16.2.9 RTC Interrupt Register.....	353
CHAPTER 17 DSU (DEADMAN'S SWITCH UNIT)	355
17.1 GENERAL	355
17.2 REGISTER SET	355
17.2.1 DSUCNTREG (0x0B00 00E0)	356
17.2.2 DSUSETREG (0x0B00 00E2).....	357
17.2.3 DSUCLRREG (0x0B00 00E4)	358
17.2.4 DSUTIMREG (0x0B00 00E6)	359
17.3 REGISTER SETTING FLOW	360
CHAPTER 18 GIU (GENERAL PURPOSE I/O UNIT)	361
18.1 GENERAL	361
18.2 REGISTER SET	362
18.2.1 GIUIOSELL (0x0B00 0100).....	363
18.2.2 GIUIOSELH (0x0B00 0102).....	364
18.2.3 GIUIODL (0x0B00 0104).....	365
18.2.4 GIUIODH (0x0B00 0106).....	366
18.2.5 GIUINTSTATL (0x0B00 0108).....	367
18.2.6 GIUINTSTATH (0x0B00 010A).....	368
18.2.7 GIUINTENL (0x0B00 010C)	369
18.2.8 GIUINTENH (0x0B00 010E)	370
18.2.9 GIUINTTYPL (0x0B00 0110).....	371
18.2.10 GIUINTTYPH (0x0B00 0112).....	372
18.2.11 GIUINTALSELL (0x0B00 0114)	373
18.2.12 GIUINTALSELH (0x0B00 0116).....	374
18.2.13 GIUINTHTSELL (0x0B00 0118)	375
18.2.14 GIUINTHTSELH (0x0B00 011A)	376
18.2.15 GIUPODATL (0x0B00 011C).....	378
18.2.16 GIUPODATH (0x0B00 011E)	380

CHAPTER 19 PIU (TOUCH PANEL INTERFACE UNIT)	381
19.1 GENERAL	381
19.1.1 Block Diagrams	382
19.2 SCAN SEQUENCER STATE TRANSITION	384
19.3 REGISTER SET	386
19.3.1 PIUCNTREG (0x0B00 0122)	387
19.3.2 PIUINTREG (0x0B00 0124).....	390
19.3.3 PIUSIVLREG (0x0B00 0126).....	391
19.3.4 PIUSTBLREG (0x0B00 0128)	392
19.3.5 PIUCMDREG (0x0B00 012A).....	393
19.3.6 PIUASCNREG (0x0B00 0130).....	395
19.3.7 PIUAMSKREG (0x0B00 0132)	397
19.3.8 PIUCIVLREG (0x0B00 013E)	398
19.3.9 PIUPBnmREG (0x0B00 02A0 to 0x0B00 02AE, 0x0B00 02BC to 0x0B00 02BE)	399
19.3.10 PIUABnREG (0x0B00 02B0 to 0x0B00 02B6)	400
19.4 REGISTER SETTING FLOW	401
19.5 RELATIONSHIPS AMONG TPX, TPY, AND ADIN PINS AND STATES	403
19.6 TIMING	404
19.6.1 Touch/Release Detection Timing	404
19.6.2 A/D Port Scan Timing.....	404
19.7 DATA LOSS INTERRUPT CONDITIONS	405
19.8 COMPARISON OF VR4102 AND VR4101™	407
CHAPTER 20 AIU (AUDIO INTERFACE UNIT)	409
20.1 GENERAL	409
20.2 REGISTER SET	409
20.2.1 MDMADATREG (0x0B00 0160)	410
20.2.2 SDMADATREG (0x0B00 0162).....	411
20.2.3 SODATREG (0x0B00 0166)	412
20.2.4 SCNTREG (0x0B00 0168)	413
20.2.5 SCNVRREG (0x0B00 016A).....	414
20.2.6 MIDATREG (0x0B00 0170)	415
20.2.7 MCNTREG (0x0B00 0172)	416
20.2.8 MCNVRREG (0x0B00 0174).....	417
20.2.9 DVALIDREG (0x0B00 0178).....	418
20.2.10 SEQREG (0x0B00 017A).....	419
20.2.11 INTREG (0x0B00 017C)	420
20.3 OPERATION SEQUENCE	421
20.3.1 Output (Speaker)	421
20.3.2 Input (MIC).....	422
CHAPTER 21 KIU (KEYBOARD INTERFACE UNIT)	423
21.1 GENERAL	423
21.2 REGISTER SET	423
21.2.1 KIUDATn (0x0B00 0180 to 0x0B00 018A)	424

21.2.2	KIUSCANREP (0x0B00 0190).....	425
21.2.3	KIUSCANS (0x0B00 0192).....	427
21.2.4	KIUWKS (0x0B00 0194).....	429
21.2.5	KIUWKI (0x0B00 0196).....	430
21.2.6	KIUINT (0x0B00 0198).....	431
21.2.7	KIURST (0x0B00 019A).....	432
21.2.8	KIUGPEN (0x0B00 019C).....	433
21.2.9	SCANLINE (0x0B00 019E).....	434
CHAPTER 22 DSU (DEBUG SERIAL INTERFACE UNIT)		435
22.1	GENERAL.....	435
22.2	REGISTER SET.....	435
22.2.1	PORTREG (0x0B00 01A0).....	436
22.2.2	MODEMREG (0x0B00 01A2).....	437
22.2.3	ASIM00REG (0x0B00 01A4).....	438
22.2.4	ASIM01REG (0x0B00 01A6).....	439
22.2.5	RXB0RREG (0x0B00 01A8).....	440
22.2.6	RXB0LREG (0x0B00 01AA).....	441
22.2.7	TXS0RREG (0x0B00 01AC).....	442
22.2.8	TXS0LREG (0x0B00 01AE).....	443
22.2.9	ASIS0REG (0x0B00 01B0).....	444
22.2.10	INTR0REG (0x0B00 01B2).....	445
22.2.11	BPRM0REG (0x0B00 01B6).....	446
22.2.12	DSIURESETREG (0x0B00 01B8).....	447
22.3	DESCRIPTION OF OPERATIONS.....	448
22.3.1	Data Format.....	448
22.3.2	Transmission.....	449
22.3.3	Reception.....	451
CHAPTER 23 LED (LED CONTROL UNIT)		453
23.1	GENERAL.....	453
23.2	REGISTER SET.....	453
23.2.1	LEDHTSREG (0x0B00 0240).....	454
23.2.2	LEDLTSREG (0x0B00 0242).....	455
23.2.3	LEDCNTREG (0x0B00 0248).....	456
23.2.4	LEDASTCREG (0x0B00 024A).....	457
23.2.5	LEDINTREG (0x0B00 024C).....	458
23.3	OPERATION FLOW.....	459
CHAPTER 24 SIU (SERIAL INTERFACE UNIT).....		461
24.1	GENERAL.....	461
24.2	REGISTER SET.....	461
24.2.1	SIURB (0x0C00 0000: LCR[7] = 0, Read).....	462
24.2.2	SIUTH (0x0C00 0000: LCR[7] = 0, Write).....	462
24.2.3	SIUDLL (0x0C00 0000: LCR[7] = 1).....	463

24.2.4 SIUIE (0x0C00 0001: LCR[7] = 0)	464
24.2.5 SIUDLM (0x0C00 0001: LCR[7] = 1).....	465
24.2.6 SIUIID (0x0C00 0002: Read).....	467
24.2.7 SIUFC (0x0C00 0002: Write).....	469
24.2.8 SIULC (0x0C00 0003).....	472
24.2.9 SIUMC (0x0C00 0004).....	473
24.2.10 SIULS (0x0C00 0005).....	474
24.2.11 SIUMS (0x0C00 0006)	476
24.2.12 SIUSC (0x0C00 0007).....	477
24.2.13 SIURSEL (0x0C00 0008).....	478

CHAPTER 25 HSP (MODEM INTERFACE UNIT)..... 481

25.1 GENERAL.....	481
25.2 REGISTER SET	483
25.2.1 HSP Initialize Register.....	484
25.2.2 HSP Data Register, HSP Index Register	485
25.2.3 HSP ID Register, HSP I/O Address Program Confirmation Register	493
25.2.4 HSP Signature Checking Port	493
25.3 POWER CONTROL.....	494

CHAPTER 26 FIR (FAST IrDA INTERFACE UNIT)..... 497

26.1 GENERAL.....	497
26.2 REGISTER SET	498
26.2.1 FRSTR (0x0C00 0040).....	499
26.2.2 DPINTR (0x0C00 0042)	500
26.2.3 DPCNTR (0x0C00 0044).....	501
26.2.4 TDR (0x0C00 0050).....	502
26.2.5 RDR (0x0C00 0052).....	503
26.2.6 IMR (0x0C00 0054).....	504
26.2.7 FSR (0x0C00 0056)	505
26.2.8 IRSR1 (0x0C00 0058).....	507
26.2.9 CRCSR (0x0C00 005C)	508
26.2.10 FIRCR (0x0C00 005E).....	509
26.2.11 MIRCR (0x0C00 0060).....	511
26.2.12 DMACR (0x0C00 0062)	512
26.2.13 DMAER (0x0C00 0064)	513
26.2.14 TXIR (0x0C00 0066)	514
26.2.15 RXIR (0x0C00 0068).....	515
26.2.16 IFR (0x0C00 006A)	517
26.2.17 RXSTS (0x0C00 006C).....	519
26.2.18 TXFL (0x0C00 006E).....	521
26.2.19 MRXF (0x0C00 0070)	522
26.2.20 RXFL (0x0C00 0074).....	523

CHAPTER 27 CPU INSTRUCTION SET DETAILS	525
27.1 INSTRUCTION NOTATION CONVENTIONS.....	525
27.2 LOAD AND STORE INSTRUCTIONS.....	527
27.3 JUMP AND BRANCH INSTRUCTIONS.....	528
27.4 SYSTEM CONTROL COPROCESSOR (CP0) INSTRUCTIONS	528
27.5 CPU INSTRUCTION.....	529
27.6 CPU INSTRUCTION OPCODE BIT ENCODING.....	674
CHAPTER 28 VR4102 COPROCESSOR 0 HAZARDS	677
CHAPTER 29 PLL PASSIVE COMPONENTS	683
APPENDIX A DIFFERENCES BETWEEN VR4102 AND VR4101	685
A.1 SUMMARY OF DIFFERENCES	685
A.2 DETAILS OF DIFFERENCES	686
A.2.1 CPU Core.....	686
A.2.2 Address Mapping.....	686
A.2.3 BCU.....	687
A.2.4 DMA	688
A.2.5 ICU	688
A.2.6 PMU.....	688
A.2.7 RTC	688
A.2.8 GIU	689
A.2.9 PIU.....	690
A.2.10 AIU	691
A.2.11 KIU	691
A.2.12 DSIU.....	692
A.2.13 SIU.....	692
A.2.14 Newly Added Units	693
APPENDIX B INDEX	695

LIST OF FIGURES (1/4)

Fig. No.	Title	Page
1-1	VR4102 Internal Block Diagram and Example of Connection to External Blocks.....	30
1-2	VR4100 CPU Core Internal Block Diagram	43
1-3	VR4102 CPU Registers	45
1-4	CPU Instruction Formats.....	46
1-5	Little-Endian Byte Ordering in Word Data.....	47
1-6	Little-Endian Byte Ordering in Double Word Data	48
1-7	Misaligned Word Accessing (Little-Endian)	48
1-8	CP0 Registers.....	49
1-9	External Circuit of Clock Oscillator.....	54
1-10	Examples of Oscillator with Bad Connection	55
2-1	VR4102 Signal Classification.....	62
3-1	CPU Instruction Formats.....	81
3-2	Byte Specification Related to Load and Store Instructions	83
4-1	Pipeline Stages.....	99
4-2	Instruction Execution in the Pipeline	100
4-3	Pipeline Activities	100
4-4	Branch Delay	102
4-5	Add Instruction Pipeline Activities.....	103
4-6	JALR Instruction Pipeline Activities	104
4-7	BEQ Instruction Pipeline Activities.....	105
4-8	TLT Instruction Pipeline Activities.....	106
4-9	LW Instruction Pipeline Activities	107
4-10	SW Instruction Pipeline Activities	108
4-11	Interlocks, Exceptions, and Faults	109
4-12	Exception Detection	112
4-13	Data Cache Miss Stall.....	113
4-14	CACHE Instruction Stall.....	113
4-15	Load Data Interlock.....	114
4-16	MD Busy Interlock.....	114
5-1	Virtual-to-Physical Address Translation	118
5-2	32-bit Mode Virtual Address Translation.....	119
5-3	64-bit Mode Virtual Address Translation.....	120
5-4	User Mode Address Space	122
5-5	Supervisor Mode Address Space	125
5-6	Kernel Mode Address Space	128
5-7	xkphys Area Address Space.....	129
5-8	VR4102 Physical Address Space	135
5-9	CP0 Registers and the TLB	141
5-10	Format of a TLB Entry.....	142
5-11	Format of a TLB Entry.....	143

LIST OF FIGURES (2/4)

Fig. No.	Title	Page
5-12	Index Register	146
5-13	Random Register	146
5-14	Positions Indicated by the Wired Register	148
5-15	Wired Register	148
5-16	PRId Register	149
5-17	Config Register Format.....	150
5-18	LLAddr Register.....	151
5-19	TagLo and TagHi Registers.....	152
5-20	TLB Address Translation	154
6-1	Context Register Format.....	160
6-2	BadVAddr Register Format.....	161
6-3	Count Register Format	161
6-4	Compare Register Format	162
6-5	Status Register Format.....	162
6-6	Status Register Diagnostic Status Field	163
6-7	Cause Register Format.....	165
6-8	EPC Register Format.....	167
6-9	WatchLo and WatchHi Register Format	168
6-10	XContext Register Format	169
6-11	Parity Error Register Format.....	170
6-12	CacheErr Register Format.....	171
6-13	The ErrorEPC Register Format	172
6-14	Common Exception Handler.....	192
6-15	TLB/XTLB Refill Exception Handler.....	194
6-16	Cache Error Exception Handler.....	196
6-17	Cold Reset, Soft Reset, and NMI Exception Handler	197
7-1	RTC Reset.....	200
7-2	RSTSW.....	201
7-3	Deadman's Switch	202
7-4	Software Shutdown.....	203
7-5	HALTimer Shutdown.....	204
7-6	VR4102 Activation Sequence (when Battery Check Is OK)	206
7-7	VR4102 Activation Sequence (when Battery Check Is NG)	206
7-8	Cold Reset.....	209
7-9	Soft Reset.....	209
8-1	Logical Hierarchy of Memory	213
8-2	Cache Support.....	214
8-3	Cache Line Format	215
8-4	Data Cache Line Format.....	215
8-5	Cache Data and Tag Organization	216
8-6	Data Cache State Diagram.....	219

LIST OF FIGURES (3/4)

Fig. No.	Title	Page
8-7	Instruction Cache State Diagram	219
8-8	Data flow on Instruction Fetch	220
8-9	Data Integrity on Load Operations	221
8-10	Data Integrity on Store Operations	222
8-11	Data Integrity on Index_Invalidate Operations.....	223
8-12	Data Integrity on Index_Writeback_Invalidate Operations.....	223
8-13	Data Integrity on Index_Load_Tag Operations	224
8-14	Data Integrity on Index_Store_Tag Operations	224
8-15	Data Integrity on Create_Dirty Operations.....	225
8-16	Data Integrity on Hit_Invalidate Operations	225
8-17	Data Integrity on Hit_Writeback_Invalidate Operations	226
8-18	Data Integrity on Fill Operations	226
8-19	Data Integrity on Hit_Writeback Operations.....	227
8-20	Data Integrity on Writeback Flow	228
8-21	Data Integrity on Refill Flow	228
8-22	Data Integrity on Writeback & Refill Flow.....	229
9-1	Non-maskable Interrupt Signal	231
9-2	Hardware Interrupt Signals	233
9-3	Masking of the CPU Core Interrupts	234
10-1	ROM 4-byte Read, 16-bit Mode (WROMA[2:0] = 110).....	253
10-2	ROM 4-byte Read, 32-bit Mode (WROMA[2:0] = 110).....	253
10-3	PageROM 4-word Read, 16-bit Mode (WROMA[2:0] = 111, WPROM[1:0] = 10)	254
10-4	PageROM 4-word Read, 32-bit Mode (WROMA[2:0] = 111, WPROM[1:0] = 10)	255
10-5	Flash Memory Mode, 2-byte Access.....	255
10-6	1-byte Access to Even Address Using 16-bit Bus (WISAA[2:0] = 101).....	256
10-7	2-byte Access when Sampling IOCHRDY at High Level Using 16-bit Bus (WISAA[2:0] = 101)	257
10-8	1-byte Access to Odd Address Using 16-bit Bus (WISAA[2:0] = 101)	258
10-9	1-byte Access to Odd Address Using 8-bit Bus (WISAA[2:0] = 101)	258
10-10	2-byte Access when Sampling ZWS# at Low Level on 16-bit Bus (WISAA[2:0] = 101)	259
10-11	2-byte Access when Sampling ZWS# at Low Level on 8-bit Bus (WISAA[2:0] = 101)	260
10-12	2-byte Access on 16-bit Bus (WLCD/M[2:0] = 101)	261
10-13	1-byte Access on 8-bit Bus (WLCD/M[2:0] = 101)	261
10-14	2-byte Access When Sampling ZWS# at Low Level on 16-bit Bus (WLCD/M[2:0] = 101).....	262
10-15	1-byte Access When Sampling ZWS# at Low Level on 8-bit Bus (WLCD/M[2:0] = 101).....	262
10-16	2-byte Access to LCD Controller (WLCD/M[2:0] = 010).....	263
10-17	2-byte Access to LCD Controller (WLCD/M[2:0] = 011).....	263
10-18	4-byte Access to DRAM (16-bit Mode)	264
10-19	8-byte Access to DRAM (32-bit Mode)	264
10-20	Byte Read of Odd Address in DRAM (16-bit Mode).....	265
10-21	Byte Read of Even Address in DRAM (16-bit Mode)	265
10-22	Byte Write to Odd Address in DRAM (16-bit Mode).....	266
10-23	Byte Write to Even Address in DRAM (16-bit Mode)	266

LIST OF FIGURES (4/4)

Fig. No.	Title	Page
10-24	CBR Refresh (16-bit Mode)	267
10-25	Self Refresh (16-bit Mode).....	267
10-26	Bus Hold in Fullspeed Mode.....	268
10-27	Bus Hold in Suspend Mode	269
11-1	DMA Space Used in DMA Transfers	271
13-1	Block Diagram of CMU and Peripheral Blocks	289
14-1	Interrupt Control Outline	293
15-1	Activation via Power Switch Interrupt (BATTINH/BATTINT# = 1).....	321
15-2	Activation via Power Switch Interrupt (BATTINH/BATTINT# = 0).....	321
15-3	Activation via GPIO Activation Interrupt (BATTINH/BATTINT# = 1).....	322
15-4	Activation via GPIO Activation Interrupt (BATTINH/BATTINT# = 0).....	322
15-5	Activation via DCD Interrupt (BATTINH/BATTINT# = 1).....	323
15-6	Activation via DCD Interrupt (BATTINH/BATTINT# = 0).....	323
15-7	Activation via Alarm Interrupt (BATTINH/BATTINT# = 1)	324
15-8	Activation via Alarm Interrupt (BATTINH/BATTINT# = 0)	324
15-9	Power Mode State Transition	325
19-1	PIU Peripheral Block Diagram	382
19-2	Equivalent Circuit of Coordinate Detection.....	382
19-3	Internal Block Diagram of PIU	383
19-4	Scan Sequencer State Transition Diagram	384
19-5	Interval Times and States	391
19-6	Touch/Release Detection Timing.....	404
19-7	A/D Port Scan Timing	404
22-1	Data Format for Transmission and Reception	448
22-2	Transmit Complete Interrupt Timing	450
22-3	Receive Complete Interrupt Timing	451
22-4	Receive Error Timing	452
24-1	Connection Example Between The VR4102 and IrDA Module	479
25-1	HSP Unit Block Diagram.....	482
25-2	Circuit Configuration Block Diagram Examples.....	482
25-3	Block Diagram of HSP Interface Power Control	494
27-1	VR4102 Opcode Bit Encoding.....	674
29-1	Example of Connection of PLL Passive Components	683

LIST OF TABLES (1/4)

Table. No.	Title	Page
1-1	BCU Registers	33
1-2	DMAAU Registers.....	33
1-3	DCU Registers	34
1-4	CMU Register	34
1-5	ICU Registers.....	35
1-6	PMU Registers.....	35
1-7	RTC Registers	36
1-8	DSU Registers	37
1-9	GIU Registers	37
1-10	PIU Registers.....	38
1-11	AIU Registers.....	39
1-12	KIU Registers.....	40
1-13	DSIU Registers	40
1-14	LED Registers.....	41
1-15	SIU Registers.....	41
1-16	HSP Registers	41
1-17	FIR Registers.....	42
1-18	System Control Coprocessor (CP0) Register Definitions	50
2-1	System Bus Interface Signals	63
2-2	Clock Interface Signals	65
2-3	Battery Monitor Interface Signals.....	65
2-4	Initialization Interface Signals	66
2-5	RS-232-C Interface Signals	67
2-6	IrDA Interface Signals	68
2-7	Debug Serial Interface Signals	68
2-8	Keyboard Interface Signals.....	69
2-9	Audio Interface Signals.....	69
2-10	Touch Panel/General Purpose A/D Interface Signals.....	69
2-11	General-purpose I/O Signals	70
2-12	HSP MODEM Interface Signals	71
2-13	LED Interface Signal	71
2-14	Dedicated V _{DD} and GND Signals	72
2-15	Status of Pins upon Reset	73
2-16	Connection of Unused Pins and Pin I/O Circuit Type	76
3-1	Number of Delay Slot Cycles Necessary for Load and Store Instructions.....	82
3-2	Load/store Instruction	84
3-3	Load/store Instruction (Extended ISA).....	85
3-4	ALU Immediate Instruction.....	86
3-5	ALU Immediate Instruction (Extended ISA)	87
3-6	Three Operand Type Instruction.....	87
3-7	Three Operand Type Instruction (Extended ISA).....	88
3-8	Shift Instruction	88

LIST OF TABLES (2/4)

Table. No.	Title	Page
3-9	Shift Instruction (Extended ISA).....	89
3-10	Multiply/Divide Instructions	90
3-11	Multiply/Divide Instructions (Extended ISA).....	90
3-12	Number of Stall Cycles in Multiply and Divide Instructions.....	91
3-13	Number of Delay Slot Cycles in Jump and Branch Instructions	92
3-14	Jump Instructions	93
3-15	Branch Instructions.....	94
3-16	Branch Instructions (Extended ISA).....	95
3-17	Special Instructions	96
3-18	Special Instructions (Extended ISA)	96
3-19	System Control Coprocessor (CP0) Instructions.....	97
4-1	Description of Pipeline Activities during Each Stage	101
4-2	Correspondence of Pipeline Stage to Interlock and Exception Condition	110
4-3	Description of Pipeline Exception	111
4-4	Pipeline Interlock	111
5-1	Comparison of useg and xuseg.....	122
5-2	32-bit and 64-bit Supervisor Mode Segments	126
5-3	32-bit Kernel Mode Segments	130
5-4	64-bit Kernel Mode Segments	132
5-5	Cacheability and the xkphys Address Space	133
5-6	V _R 4102 Physical Address Space.....	136
5-7	ROM Addresses (when using 16-bit data bus).....	137
5-8	ROM Addresses (when using 32-bit data bus).....	137
5-9	Internal I/O Space 1.....	139
5-10	Internal I/O Space 2.....	139
5-11	DRAM Addresses (when using 16-bit data bus).....	140
5-12	DRAM Addresses (when using 32-bit data bus).....	140
5-13	Cache Algorithm	145
5-14	Mask Values and Page Sizes.....	147
6-1	CP0 Exception Processing Registers.....	159
6-2	Cause Register Exception Code Field.....	166
6-3	64-Bit Mode Exception Vector Base Addresses.....	174
6-4	32-Bit Mode Exception Vector Base Addresses.....	174
6-5	Exception Priority Order.....	176
10-1	BCU Registers.....	235
10-2	Address Bit Correspondence between ADD Bus and External Devices	246
10-3	Address Connection Table with External Devices	246
10-4	Access Size Restrictions for Address Spaces.....	247
10-5	Summary of ROM Modes	248
10-6	Example of Bit Inversion in Data in V _R 4102 and at DATA [15:0] Pins	250

LIST OF TABLES (3/4)

Table. No.	Title	Page
10-7	Illegal Access Notification Methods	251
10-8	Access Times during Ordinary ROM Read Mode	252
10-9	PageROM Read Mode Access Time	254
10-10	System Bus Access Times	256
10-11	High-Speed System Bus Access Times	260
10-12	Access Times for LCD Interface	263
11-1	DMAAU Registers	272
12-1	DMA Priority Levels	281
12-2	DCU Registers	281
13-1	CMU Register	289
14-1	ICU Registers.....	294
15-1	Bit Operations during Reset.....	319
15-2	Bit Operations during Shutdown	320
15-3	Power Mode	326
15-4	PMU Registers	327
16-1	RTC Registers	336
17-1	DSU Registers	355
18-1	GPIO Pin Functions	361
18-2	GIU Registers	362
18-3	Table of Correspondences between GPIO[47..32] and Function Pins	379
18-4	Table of Correspondence between GPIO[48] and Function Pin.....	380
19-1	PIU Registers.....	386
19-2	PIUCNTREG Bit Manipulation and States	389
19-3	PIUASCNREG Bit Manipulation and States.....	396
19-4	Detected Coordinates and Page Buffers	399
19-5	A/D Ports and Data Buffers.....	400
19-6	Comparison of PIUs of VR4102 and VR4101.....	407
20-1	AIU Registers.....	409
21-1	KIU Registers.....	423
22-1	DSIU Registers	435
22-2	Receive Error Causes.....	452

LIST OF TABLES (4/4)

Table. No.	Title	Page
23-1	LED Registers.....	453
24-1	SIU Registers.....	461
24-2	Correspondence between Baud Rates and Divisors	466
24-3	Interrupt Function	468
25-1	HSP Registers	483
25-2	Control Register Definitions.....	485
26-1	FIR Registers.....	498
27-1	CPU Instruction Operation Notations.....	526
27-2	Load and Store Common Functions	527
27-3	Access Type Specifications for Loads/Stores	528
28-1	VR4102 Coprocessor 0 Hazards.....	678
28-2	Calculation Example of CP0 Hazard and the Number of Instructions Inserted	681

[MEMO]

CHAPTER 1 INTRODUCTION

This chapter describes the outline of the VR4102 (μ PD30102), which is a 64-/32-bit RISC microprocessor.

1.1 FEATURES

The VR4102, which is a high-performance 64-/32-bit microprocessor employing the RISC (reduced instruction set computer) architecture developed by MIPS, is one of the RISC microprocessor VR-Series™ products manufactured by NEC.

The VR4102 is ideally suited for battery-driven high-performance portable information equipment.

It mainly consists of the high-performance ultra-low-power consumption VR4102 CPU core, and has various peripheral functions including a DMA controller, software modem interface, serial interface, keyboard interface, IrDA interface, touch panel interface, real-time clock, A/D converter, and D/A converter.

The external bus width of this device can be selected between 32 bits and 16 bits. This function enables the VR4102 to process voluminous data at high speed.

The features of the VR4102 are described below.

- ◇ Employs 64-bit RISC CPU Core (VR4100 equivalent)
- ◇ Internal 64-bit processing
- ◇ Optimized 5-stage pipeline
- ◇ Conforms to MIPS I, II, III instruction sets (with the FPU, LL, and SC instructions left out)
- ◇ Supports high-speed product-sum operation instructions to execute applications in high speed
- ◇ On-chip 4-Kbyte instruction cache and 1-Kbyte data cache
- ◇ 32-double-entry translation lookaside buffer (TLB) for virtual address management
- ◇ 32-bit physical address space and 40-bit virtual address space (in 64-bit mode)
- ◇ On-chip peripheral units suited for portable equipment
 - Memory controller (supports ROM, EDO-type DRAM, and flash memory)
 - ISA-bus interface
 - Keyboard interface
 - Touch panel interface (on-chip 4-channel A/D converter)
 - Controller complying with IrDA 1.1 (FIR)
 - Software modem interface
 - DMA controller
 - Serial interface
 - Debug serial interfaces
 - Interrupt controller
 - Audio interface (on-chip digital I/O, A/D and D/A converters)
 - General-purpose A/D converter: 3 channels
 - General-purpose ports
- ◇ Effective power management features, which include the following four operating modes:
 - Fullspeed mode: normal operating mode in which all clocks operate
 - Standby mode: all internal clocks stop except for interrupt-related clocks
 - Suspend mode: bus clock and all internal clocks stop except for interrupt-related clocks
 - Hibernate mode: all clocks generated by the CPU core stop

- ◇ External input clock: 32.768 kHz, 18.432 MHz (for internal CPU core and peripheral unit operation), 48 MHz (dedicated for FIR IrDA interface)
- ◇ Supports ISA bus subset
- ◇ Clock supply management function for each on-chip peripheral unit to implement low-power consumption
- ◇ Operation supply voltage: $V_{DD} = 3.0$ to 3.6 V

1.2 ORDERING INFORMATION

Part Number	Package	Maximum Operation Frequency
μ PD30102GM-54-8EV	216-pin plastic LQFP (fine pitch) (24 × 24 mm)	54 MHz
μ PD30102GM-66-8EV	216-pin plastic LQFP (fine pitch) (24 × 24 mm)	66 MHz
μ PD30102S1-54-3C	224-pin plastic FBGA (16 × 16 mm)	54 MHz
μ PD30102S1-66-3C	224-pin plastic FBGA (16 × 16 mm)	66 MHz

1.3 64-BIT ARCHITECTURE

The Vr4102 microprocessor has a 64-bit architecture. However, it can also run 32-bit applications.

1.4 VR4102 PROCESSOR

The Vr4102 consists of the Vr4100 CPU core and seventeen peripheral units. It can connect external controllers directly.

Figure 1-1 is an internal block diagram of the Vr4102 processor.

Figure 1-1. Vr4102 Internal Block Diagram and Example of Connection to External Blocks

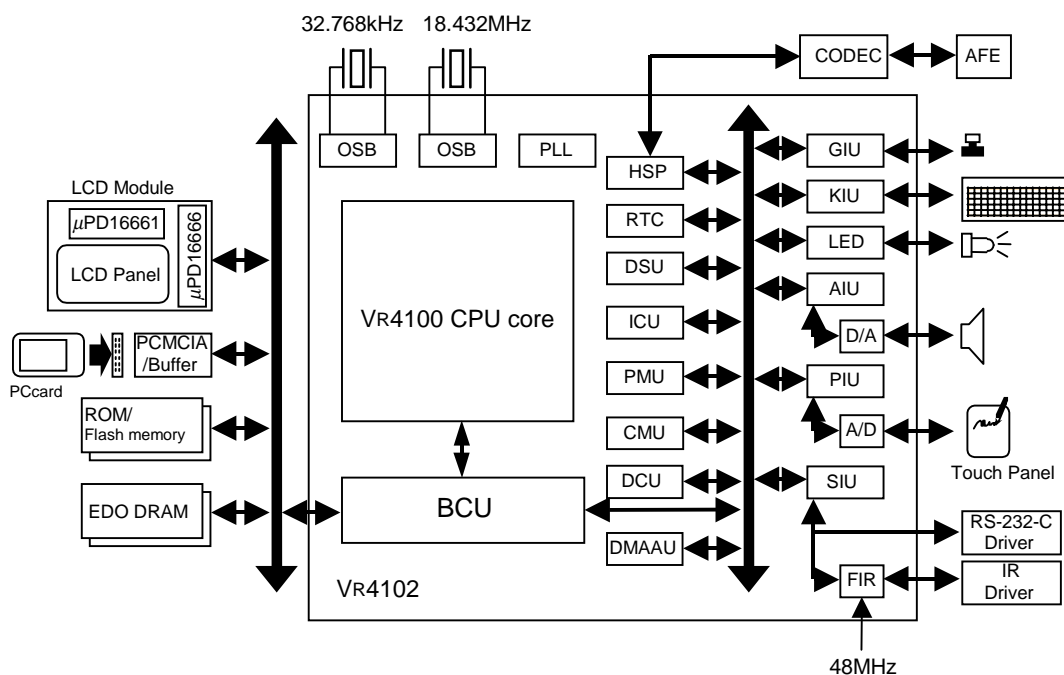

1.4.1 Internal Block Structure

The following provides an outline of the peripheral units.

For the CPU core, refer to **1.5 VR4100 CPU CORE**.

(1) Bus Control Unit (BCU)

In the VR4102, the bus control unit (BCU) transfers data between the VR4100 CPU core and SysAD bus. It also controls external circuits, such as the LCD controller connected to the system bus, DRAM, ROM (flash memory or masked ROM), and PCMCIA controller, and transfers data between the VR4102 and these external devices, using the address and data buses.

(2) Real-time Clock Unit (RTC)

The real-time clock (RTC) is provided with an accurate counter that operates on a 32.768-kHz clock pulse supplied from the clock generator. It is also provided with several counters and Compare registers for controlling various interrupts.

(3) Deadman's Switch Unit (DSU)

The Deadman's switch unit (DSU) is used to check whether the processor is running normally. If the register of this unit is not cleared by software within a specified period, the system is shut down.

(4) Interrupt Control Unit (ICU)

The interrupt control unit (ICU) controls interrupt requests that are caused by factors either internal or external to the VR4102, and informs the VR4100 CPU core when an interrupt request occurs.

(5) Power Management Unit (PMU)

The power management unit (PMU) outputs signals necessary to control the power of the entire system including the VR4102. The signals are used to control the PLL of the VR4100 CPU core and the internal clocks (pipeline clock, TClock, and MasterOut) in low-power modes.

(6) Direct Memory Access Address Unit (DMAAU)

The direct memory access address unit (DMAAU) controls the address of three different DMA transfers.

(7) Direct Memory Access Control Unit (DCU)

The direct memory access control unit (DCU) controls the arbitration of three different DMA transfers.

(8) Clock Mask Unit (CMU)

The clock mask unit (CMU) controls the way the clocks TClock and MasterOut are supplied from the VR4100 CPU core to internal peripheral units.

(9) General Purpose I/O Unit (GIU)

The general purpose I/O unit (GIU) controls 49 GPIO pins.

(10) Audio Interface Unit (AIU)

The audio interface unit (AIU) executes mic-input sampling and audio signal output by controlling the internal A/D converter and D/A converter.

(11) Keyboard Interface Unit (KIU)

The keyboard interface unit (KIU) has 12 scan lines and 8 detection lines. It can detect when any of 64/80/96 keys are pressed. It supports key rollover for two to three continuous strokes.

(12) Touch Panel Interface Unit (PIU)

The touch panel interface unit (PIU) detects when the touch panel is touched, by controlling the internal A/D converter.

(13) Debug Serial Interface Unit (DSIU)

The debug serial interface unit (DSIU) is a serial interface for debugging. It supports a maximum transfer rate of 115 kbps.

www.DataSheet4U.com

(14) Serial Interface Unit (SIU)

The serial interface unit (SIU) conforms to the RS-232-C specification and is compatible with 16550. It supports a maximum transfer rate of 1.15 Mbps. Also available is an IrDA serial interface supporting a maximum transfer rate of 115 kbps, but this interface and the RS-232-C interface are mutually exclusive.

(15) Fast IrDA Interface Unit (FIR)

The FIR unit is a unit for performing 0.5- to 4-Mbps IrDA communication. This unit operates based on a dedicated 48-MHz clock input.

(16) Host Signal Processing Unit (HSP)

The HSP unit is used to realize a software modem. It interfaces the CPU core with an external codec device, and controls them.

(17) Light Emitting Diode Unit (LED)

The LED unit is used to control the lighting of external LED.

1.4.2 I/O Registers

The I/O registers are used for peripheral unit control.

Table 1-1. BCU Registers

Register symbols	Function	Address
BCUCNTREG 1	BCU Control Register 1	0x0B00 0000
BCUCNTREG 2	BCU Control Register 2	0x0B00 0002
BCUSPEEDREG	BCU Access Cycle Change Register	0x0B00 000A
BCUERRSTREG	BCU BUS ERROR Status Register	0x0B00 000C
BCURFCNTREG	BCU Refresh Control Register	0x0B00 000E
REVIDREG	Peripheral Unit Revision ID Register	0x0B00 0010
BCURFCOUNTREG	BCU Refresh Cycle Count Register	0x0B00 0012
CLKSPEEDREG	Clock Setting Register	0x0B00 0014

Table 1-2. DMAAU Registers

Register symbols	Function	Address
AIUIBALREG	AIU IN DMA Base Address Register Low	0x0B00 0020
AIUIBAHREG	AIU IN DMA Base Address Register High	0x0B00 0022
AIUIALREG	AIU IN DMA Address Register Low	0x0B00 0024
AIUIAHREG	AIU IN DMA Address Register High	0x0B00 0026
AIUOBALREG	AIU OUT DMA Base Address Register Low	0x0B00 0028
AIUOBHREG	AIU OUT DMA Base Address Register High	0x0B00 002A
AIUOALREG	AIU OUT DMA Address Register Low	0x0B00 002C
AIUOAHREG	AIU OUT DMA Address Register High	0x0B00 002E
FIRBALREG	FIR DMA Base Address Register Low	0x0B00 0030
FIRBAHREG	FIR DMA Base Address Register High	0x0B00 0032
FIRALREG	FIR DMA Address Register Low	0x0B00 0034
FIRAHREG	FIR DMA Address Register High	0x0B00 0036

Table 1-3. DCU Registers

Register symbols	Function	Address
DMARSTREG	DMA Reset Register	0x0B00 0040
DMAIDLEREG	DMA Sequencer Status Register	0x0B00 0042
DMASENREG	DMA Sequencer Enable Register	0x0B00 0044
DMAMSKREG	DMA Mask Register	0x0B00 0046
DMAREQREG	DMA Request Register	0x0B00 0048
TDREG	Transfer Direction Setting Register	0x0B00 004A

www.DataSheet4U.com

Table 1-4. CMU Register

Register symbol	Function	Address
CMUCLKMSK	CMU Clock Mask Register	0x0B00 0060

Table 1-5. ICU Registers

Register symbols	Function	Address
SYSINT1REG	Level 1 System Interrupt Register 1	0x0B00 0080
PIUINTREG	Level 2 PIU Interrupt Register	0x0B00 0082
AIUINTREG	Level 2 AIU Interrupt Register	0x0B00 0084
KIUINTREG	Level 2 KIU Interrupt Register	0x0B00 0086
GIUINTLREG	Level 2 GIU Interrupt Register Low	0x0B00 0088
DSIUINTREG	Level 2 DSIU Interrupt Register	0x0B00 008A
MSYSINT1REG	Level 1 Mask System Interrupt Register 1	0x0B00 008C
MPIUINTREG	Level 2 Mask PIU Interrupt Register	0x0B00 008E
MAIUINTREG	Level 2 Mask AIU Interrupt Register	0x0B00 0090
MKIUINTREG	Level 2 Mask KIU Interrupt Register	0x0B00 0092
MGIUINTLREG	Level 2 Mask GIU Interrupt Register Low	0x0B00 0094
MDSIUINTREG	Level 2 Mask DSIU Interrupt Register	0x0B00 0096
NMIREG	Battery Interrupt Select Register	0x0B00 0098
SOFTINTREG	Software Interrupt Register	0x0B00 009A
SYSINT2REG	Level 1 System Interrupt Register 2	0x0B00 0200
GIUINTHREG	Level 2 GIU Interrupt Register High	0x0B00 0202
FIRINTREG	Level 2 FIR Interrupt Register	0x0B00 0204
MSYSINT2REG	Level 1 Mask System Interrupt Register 2	0x0B00 0206
MGIUINTHREG	Level 2 Mask GIU Interrupt Register High	0x0B00 0208
MFIRINTREG	Level 2 Mask FIR Interrupt Register	0x0B00 020A

Table 1-6. PMU Registers

Register symbols	Function	Address
PMUINTREG	PMU Interrupt/Status Register	0x0B00 00A0
PMUCNTREG	PMU Control Register	0x0B00 00A2
PMUINT2REG	PMU Interrupt Register 2	0x0B00 00A4
PMUCNT2REG	PMU Control Register 2	0x0B00 00A6

Table 1-7. RTC Registers

Register symbols	Function	Address
ETIMELREG	Elapsed Time L Register	0x0B00 00C0
ETIMEMREG	Elapsed Time M Register	0x0B00 00C2
ETIMEHREG	Elapsed Time H Register	0x0B00 00C4
ECMPLREG	Elapsed Compare L Register	0x0B00 00C8
ECMPMREG	Elapsed Compare M Register	0x0B00 00CA
ECMPHREG	Elapsed Compare H Register	0x0B00 00CC
RTCL1LREG	RTC Long 1 L Register	0x0B00 00D0
RTCL1HREG	RTC Long 1 H Register	0x0B00 00D2
RTCL1CNTLREG	RTC Long 1 Count L Register	0x0B00 00D4
RTCL1CNTHREG	RTC Long 1 Count H Register	0x0B00 00D6
RTCL2LREG	RTC Long 2 L Register	0x0B00 00D8
RTCL2HREG	RTC Long 2 H Register	0x0B00 00DA
RTCL2CNTLREG	RTC Long 2 Count L Register	0x0B00 00DC
RTCL2CNTHREG	RTC Long 2 Count H Register	0x0B00 00DE
TCLKLREG	TClock L Register	0x0B00 01C0
TCLKHREG	TClock H Register	0x0B00 01C2
TCLKCNTLREG	TClock Count L Register	0x0B00 01C4
TCLKCNTHREG	TClock Count H Register	0x0B00 01C6
RTCINTREG	RTC Interrupt Register	0x0B00 01DE

Table 1-8. DSU Registers

Register symbols	Function	Address
DSUCNTREG	DSU Control Register	0x0B00 00E0
DSUSETREG	DSU Cycle (Dead Time) Set Register	0x0B00 00E2
DSUCLRREG	DSU Clear Register	0x0B00 00E4
DSUTIMREG	DSU Elapsed Time Register	0x0B00 00E6

Table 1-9. GIU Registers

Register symbols	Function	Address
GIUIOSELL	GPIO Input/Output Select Register L	0x0B00 0100
GIUIOSELH	GPIO Input/Output Select Register H	0x0B00 0102
GIUIODL	GPIO Port Input/Output Data Register L	0x0B00 0104
GIUIODH	GPIO Port Input/Output Data Register H	0x0B00 0106
GIUINTSTATL	GPIO Interrupt Status Register L	0x0B00 0108
GIUINTSTATH	GPIO Interrupt Status Register H	0x0B00 010A
GIUINTENL	GPIO Interrupt Enable Register L	0x0B00 010C
GIUINTENH	GPIO Interrupt Enable Register H	0x0B00 010E
GIUINTTYPL	GPIO Interrupt Type (Edge or Level) Select Register L	0x0B00 0110
GIUINTTYPH	GPIO Interrupt Type (Edge or Level) Select Register H	0x0B00 0112
GIUINTALSELL	GPIO Interrupt Active Level Select Register L	0x0B00 0114
GIUINTALSELH	GPIO Interrupt Active Level Select Register H	0x0B00 0116
GIUINTHTSELL	GPIO Interrupt Hold/Through Select Register L	0x0B00 0118
GIUINTHTSELH	GPIO Interrupt Hold/Through Select Register H	0x0B00 011A
GIUPODATL	GPIO Port Output Data Register L	0x0B00 011C
GIUPODATH	GPIO Port Output Data Register H	0x0B00 011E

Table 1-10. PIU Registers

Register symbols	Function	Address
PIUCNTREG	PIU Control Register	0x0B00 0122
PIUINTREG	PIU Interrupt Cause Register	0x0B00 0124
PIUSIVLREG	PIU Data Sampling Interval Register	0x0B00 0126
PIUSTBLREG	PIU A/D Converter Start Delay Register	0x0B00 0128
PIUCMDREG	PIU A/D Command Register	0x0B00 012A
PIUASCNREG	PIU A/D Port Scan Register	0x0B00 0130
PIUAMSKREG	PIU A/D Scan Mask Register	0x0B00 0132
PIUCIVLREG	PIU Check Interval Register	0x0B00 013E
PIUPB00REG	PIU Page 0 Buffer 0 Register	0x0B00 02A0
PIUPB01REG	PIU Page 0 Buffer 1 Register	0x0B00 02A2
PIUPB02REG	PIU Page 0 Buffer 2 Register	0x0B00 02A4
PIUPB03REG	PIU Page 0 Buffer 3 Register	0x0B00 02A6
PIUPB10REG	PIU Page 1 Buffer 0 Register	0x0B00 02A8
PIUPB11REG	PIU Page 1 Buffer 1 Register	0x0B00 02AA
PIUPB12REG	PIU Page 1 Buffer 2 Register	0x0B00 02AC
PIUPB13REG	PIU Page 1 Buffer 3 Register	0x0B00 02AE
PIUAB0REG	PIU AD Scan Buffer 0 Register	0x0B00 02B0
PIUAB1REG	PIU AD Scan Buffer 1 Register	0x0B00 02B2
PIUAB2REG	PIU AD Scan Buffer 2 Register	0x0B00 02B4
PIUAB3REG	PIU AD Scan Buffer 3 Register	0x0B00 02B6
PIUPB04REG	PIU Page 0 Buffer 4 Register	0x0B00 02BC
PIUPB14REG	PIU Page 1 Buffer 4 Register	0x0B00 02BE

Table 1-11. AIU Registers

Register symbols	Function	Address
MDMADATREG	Mike DMA Data Register	0x0B00 0160
SDMADATREG	Speaker DMA Data Register	0x0B00 0162
SODATREG	Speaker Output Data Register	0x0B00 0166
SCNTREG	Speaker Output Control Register	0x0B00 0168
SCNVRREG	Speaker Conversion Rate Register	0x0B00 016A
MIDATREG	Mike Input Data Register	0x0B00 0170
MCNTREG	Mike Input Control Register	0x0B00 0172
MCNVRREG	Mike Conversion Rate Register	0x0B00 0174
DVALIDREG	Data Valid Register	0x0B00 0178
SEQREG	Sequential Operation Enable Register	0x0B00 017A
INTREG	AIU Interrupt Register	0x0B00 017C

Table 1-12. KIU Registers

Register symbols	Function	Address
KIUDAT0	KIU Data0 Register	0x0B00 0180
KIUDAT1	KIU Data1 Register	0x0B00 0182
KIUDAT2	KIU Data2 Register	0x0B00 0184
KIUDAT3	KIU Data3 Register	0x0B00 0186
KIUDAT4	KIU Data4 Register	0x0B00 0188
KIUDAT5	KIU Data5 Register	0x0B00 018A
KIUSCANREP	KIU Scan/Repeat Register	0x0B00 0190
KIUSCANS	KIU Scan Status Register	0x0B00 0192
KIUWKS	KIU Wait Keyscan Stable Register	0x0B00 0194
KIUWKI	KIU Wait Keyscan Interval Register	0x0B00 0196
KIUINT	KIU Interrupt Register	0x0B00 0198
KIURST	KIU Reset Register	0x0B00 019A
KIUGPEN	KIU General Purpose Output Enable Register	0x0B00 019C
SCANLINE	KIU Scan Line Register	0x0B00 019E

Table 1-13. DSIU Registers

Register symbols	Function	Address
PORTREG	Port Change Register	0x0B00 01A0
MODEMREG	Modem Control Register	0x0B00 01A2
ASIM00REG	Asynchronous Mode 0 Register	0x0B00 01A4
ASIM01REG	Asynchronous Mode 1 Register	0x0B00 01A6
RXB0RREG	Receive Buffer Register (Extended)	0x0B00 01A8
RXB0LREG	Receive Buffer Register	0x0B00 01AA
TXS0RREG	Transmit Data Register (Extended)	0x0B00 01AC
TXS0LREG	Transmit Data Register	0x0B00 01AE
ASIS0REG	Status Register	0x0B00 01B0
INTR0REG	Debug SIU Interrupt Register	0x0B00 01B2
BPRM0REG	Baud-rate Generator Prescaler Mode Register	0x0B00 01B6
DSIURESETREG	Debug SIU Reset Register	0x0B00 01B8

Table 1-14. LED Registers

Register symbols	Function	Address
LEDHTSREG	LED H Time Set Register	0x0B00 0240
LEDLTSREG	LED L Time Set Register	0x0B00 0242
LEDCNTREG	LED Control Register	0x0B00 0248
LEDASTCREG	LED Auto Stop Time Count Register	0x0B00 024A
LEDINTREG	LED Interrupt Register	0x0B00 024C

Table 1-15. SIU Registers

Register symbols	Function	LCR[7]	Address
SIURB	Receiver Buffer Register (Read)	0	0x0C00 0000
SIUTH	Transmitter Holding Register (Write)		
SIUDLL	Divisor Latch (Least Significant Byte) Register	1	
SIUIE	Interrupt Enable Register	0	0x0C00 0001
SIUDLM	Divisor Latch (Most Significant Byte) Register	1	
SIUIID	Interrupt Identification Register (Read)	-	0x0C00 0002
SIUFC	FIFO Control Register (Write)		
SIULC	Line Control Register	-	0x0C00 0003
SIUMC	MODEM Control Register	-	0x0C00 0004
SIULS	Line Status Register	-	0x0C00 0005
SIUMS	MODEM Status Register	-	0x0C00 0006
SIUSC	Scratch Register	-	0x0C00 0007
SIUIRSEL	SIU/FIR IrDA Selector	-	0x0C00 0008

Remark LCR[7] is bit 7 of the SIULC register.

Table 1-16. HSP Registers

Register symbols	Function	Address
HSPINIT	HSP Initialize Register	0x0C00 0020
HSPDATA[7:0]	HSP Data Register [7:0]	0x0C00 0022
HSPDATA[15:8]	HSP Data Register [15:8]	0x0C00 0023
HSPINDEX	HSP Index Register	0x0C00 0024
HSPID[7:0]	HSP ID Register	0x0C00 0028
HSPPCS[7:0]	HSP I/O Address Program Confirmation Register	0x0C00 0029
HSPPCTEL[7:0]	HSP Signature Checking Port	0x0C00 0029

Table 1-17. FIR Registers

Register symbols	Function	Address
FRSTR	FIR Reset Register	0x0C00 0040
DPINTR	DMA Page Interrupt Register	0x0C00 0042
DPCNTR	DMA Page Control Register	0x0C00 0044
TDR	Transmit Data Register	0x0C00 0050
RDR	Receive Data Register	0x0C00 0052
IMR	Interrupt Mask Register	0x0C00 0054
FSR	FIFO Setup Register	0x0C00 0056
IRSR1	IR Setup Register 1	0x0C00 0058
CRCSR	CRC Setup Register	0x0C00 005C
FIRCR	FIR Control Register	0x0C00 005E
MIRCR	MIR Control Register	0x0C00 0060
DMACR	DMA Control Register	0x0C00 0062
DMAER	DMA Enable Register	0x0C00 0064
TXIR	Transmission Indicate Register	0x0C00 0066
RXIR	Reception Indicate Register	0x0C00 0068
IFR	Interrupt Flag Register	0x0C00 006A
RXSTS	Reception Status Register	0x0C00 006C
TXFL	Transmit Frame Length Register	0x0C00 006E
MRXF	Maximum Receive Frame Length Register	0x0C00 0070
RXFL	Receive Frame Length Register	0x0C00 0074

1.5 VR4100 CPU CORE

Figure 1-2. VR4100 CPU Core Internal Block Diagram

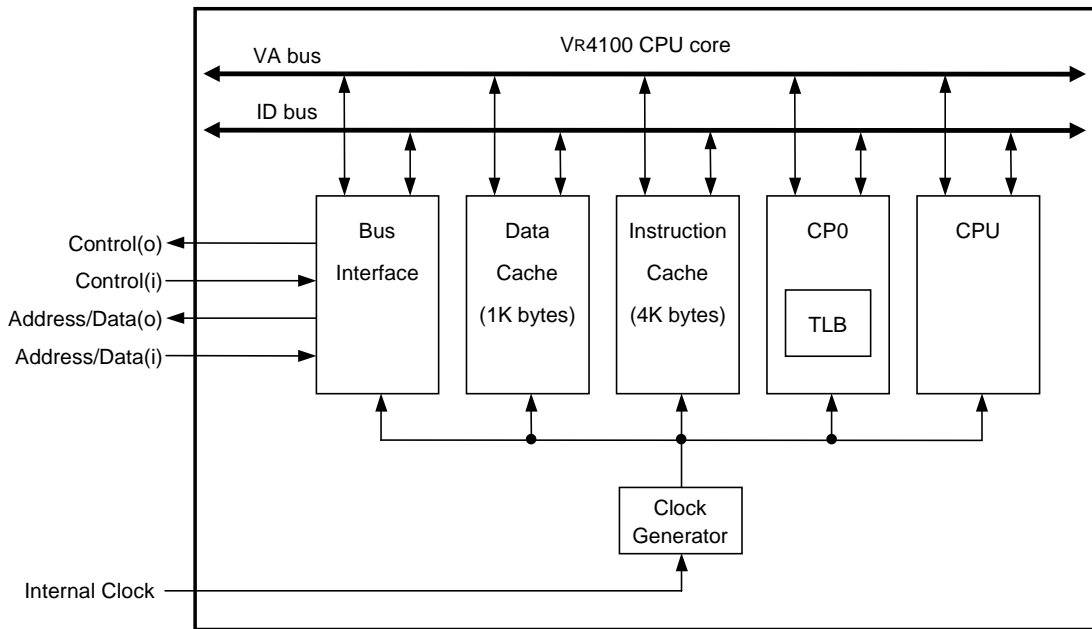

1.5.1 VR4100 CPU Core

(1) CPU bus interface

The CPU bus interface controls data transmission/reception between the VR4100 CPU core and the BCU, which is one of peripheral units. The VR4100 CPU interface consists of two 32-bit multiplexed address/data buses (one is for input, and another is for output), clock signals, and control signals such as interrupts.

(2) Clock generator

The following clock inputs are oscillated and supplied to internal units.

- 32.768-kHz clock for RTC unit:
oscillating a 32.768-kHz crystal resonator input via an internal oscillator to supply to the RTC unit.
- 8.432-MHz clock for serial interface and the VR4102's reference operating clock:
oscillating an 18.432-MHz crystal resonator input via an internal oscillator, and then multiplying it by phase-locked loop (PLL) to generate a pipeline clock (PClock). The internal bus clock (TClock) is generated from PClock and supplied to peripheral units.

(3) Instruction cache

The instruction cache employs direct mapping, virtual index, and physical tag. Its capacity is 4K bytes.

(4) CPU

CPU has hardware resources to process an integer instruction. They are the 64-bit register file, 64-bit integer data bus, and multiply-and-accumulate operation unit.

(5) Coprocessor 0 (CP0)

CP0 incorporates a memory management unit (MMU) and exception handling function. MMU checks whether there is an access between different memory segments (user, supervisor, and kernel) by executing address conversion. The translation lookaside buffer (TLB) converts virtual addresses to physical addresses.

(6) Data cache

The data cache employs direct mapping, virtual index, physical tag, and write back. Its capacity is 1K bytes.

1.5.2 CPU Registers

The Vr4100 CPU core has thirty two 64-bit general-purpose registers (GPRs).

In addition, the processor provides the following special, registers:

- ✧ 64-bit Program Counter (PC)
- ✧ 64-bit HI register, containing the integer multiply and divide upper doubleword result
- ✧ 64-bit LO register, containing the integer multiply and divide lower doubleword result

Two of the general-purpose registers have assigned the following functions:

- ✧ r0 is hardwired to a value of zero, and can be used as the target register for any instruction whose result is to be discarded. r0 can also be used as a source when a zero value is needed.
- ✧ r31 is the link register used by link instruction, such as JAL/JALR instructions. This register can be used for other instructions. However, be careful that use of the register by a link instruction will not coincide with use of the register for other operations.

The register group is provided within the CP0, to process exceptions and to manage addresses.

CPU registers can operate as either 32-bit or 64-bit registers, depending on the Vr4102 processor mode of operation.

Figure 1-3 shows the CPU registers.

Figure 1-3. Vr4102 CPU Registers

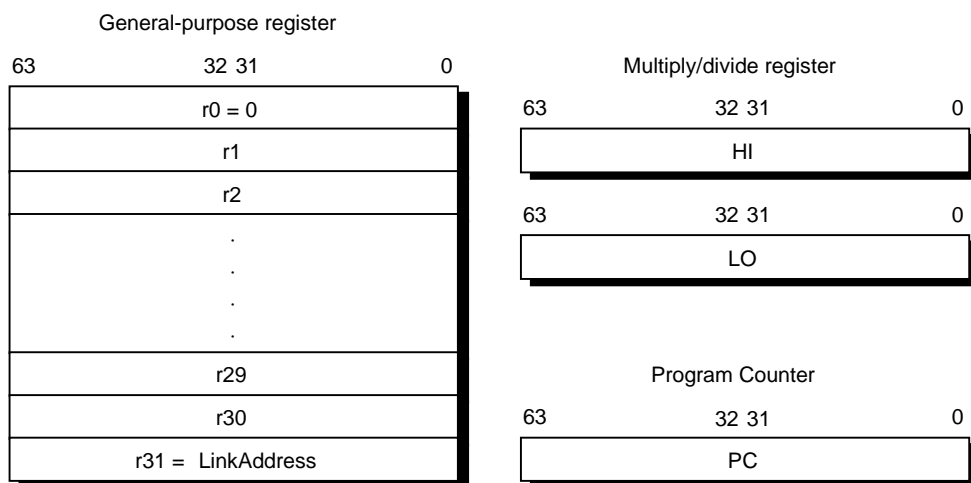

The Vr4102 has no Program Status Word (PSW) register as such; this is covered by the Status and Cause registers incorporated within the System Control Coprocessor (CP0).

The CP0 registers are used for exception handling or address management. The overview of these registers is described in **1.5.5 Coprocessors (CP0-CP3)**.

1.5.3 CPU Instruction Set Overview

Each CPU instruction is 32 bits long. As shown in Figure 1-4, there are three instruction formats:

- ✧ immediate (I-type)
- ✧ jump (J-type)
- ✧ register (R-type)

Figure 1-4. CPU Instruction Formats

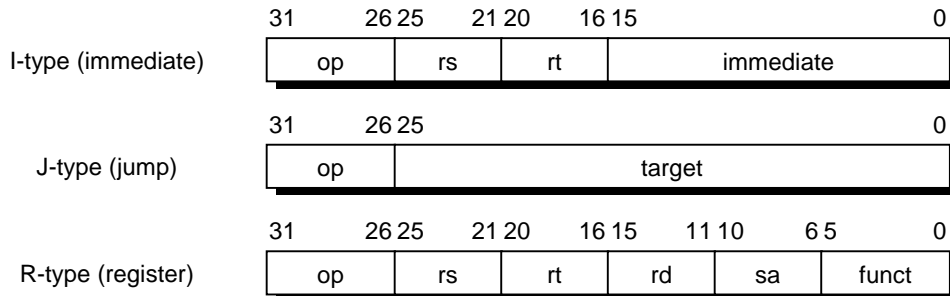

The instruction set can be further divided into the following five groupings:

- (1) Load and store instructions move data between memory and general-purpose registers. They are all immediate (I-type) instructions, since the only addressing mode supported is base register plus 16-bit, signed immediate offset.
- (2) Computational instructions perform arithmetic, logical, shift, multiply, and divide operations on values in registers. They include R-type (in which both the operands and the result are stored in registers) and I-type (in which one operand is a 16-bit signed immediate value) formats.
- (3) Jump and branch instructions change the control flow of a program. Jumps are always made to an absolute address formed by combining a 26-bit target address with the high-order bits of the Program Counter (J-type format) or register address (R-type format). The format of the branch instructions is I type. Branches have 16-bit offsets relative to the Program Counter. JAL instructions save their return address in register 31.
- (4) Coprocessor 0 (System Control Coprocessor, CP0) instructions perform operations on CP0 registers to control the memory-management and exception-handling facilities of the processor.
- (5) Special instructions perform system calls and breakpoint operations, or cause a branch to the general exception-handling vector based upon the result of a comparison. These instructions occur in both R-type (both the operands and the result are stored in registers) and I-type (one operand is a 16-bit signed immediate value) formats.

Chapter 3 provides a more detailed summary (Refer to Chapter 27 for detailed descriptions of the operation of each instruction) .

1.5.4 Data Formats and Addressing

The VR4102 uses following four data formats:

- Doubleword (64 bits)
- Word (32 bits)
- Halfword (16 bits)
- Byte (8 bits)

For the VR4100 CPU core, byte ordering within all of the larger data formats - halfword, word, doubleword - can be configured in either big-endian or little-endian order. **However, the VR4102 supports the little-endian order only.**

Endianness refers to the location of byte 0 within the multi-byte data structure. Figure 1-5 shows the ordering of bytes within words and the ordering of words within doubleword structures for the little-endian conventions.

When configured as a little-endian system, byte 0 is always the least-significant (rightmost) byte, which is compatible with iAPX™ and DEC VAX™ conventions. Figure 1-5 shows this configuration.

Figure 1-5. Little-Endian Byte Ordering in Word Data

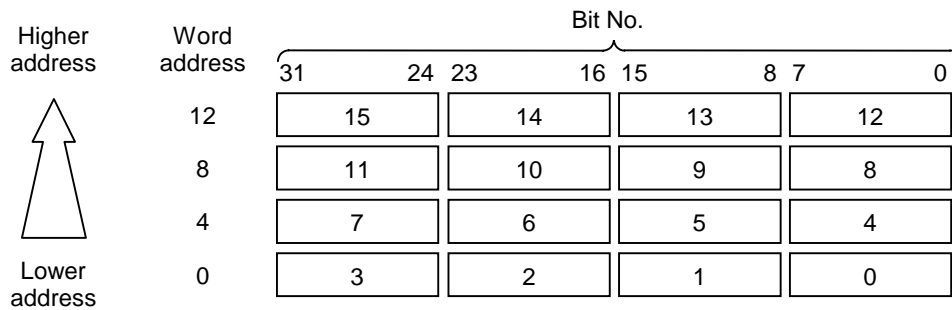

- Remarks 1.** The lowest byte is the lowest address.
2. The address of word data is specified by the lowest byte's address.

In this manual, bit 0 is always the least-significant (rightmost) bit; thus, bit designations are always little-endian. Figure 1-6 shows little-endian byte ordering in doublewords.

Figure 1-6. Little-Endian Byte Ordering in Double Word Data

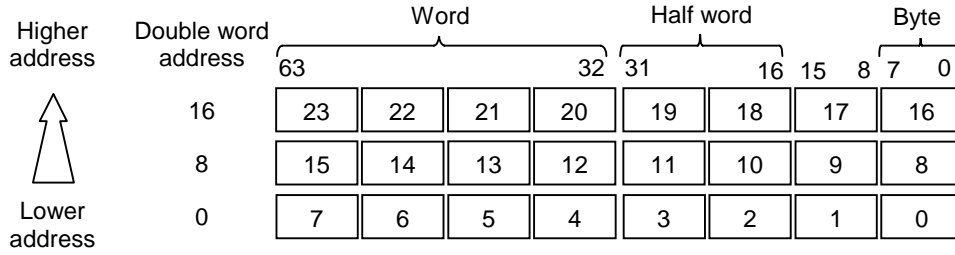

- Remarks 1.** The lowest byte is the lowest address.
2. The address of word data is specified by the lowest byte's address.

The CPU uses following byte boundaries for halfword, word, and doubleword accesses:

- ✧ Halfword: An even byte boundary (0, 2, 4...)
- ✧ Word: A byte boundary divisible by four (0, 4, 8...)
- ✧ Doubleword: A byte boundary divisible by eight (0, 8, 16...)

The following special instructions to load and store data that are not aligned on 4-byte (word) or 8-byte (doubleword) boundaries:

LWL	LWR	SWL	SWR
LDL	LDR	SDL	SDR

These instructions are used in pairs to provide an access to misaligned data. Accessing misaligned data incurs one additional instruction cycle over that required for accessing aligned data.

Figure 1-7 shows the access of a misaligned word that has byte address 3 for the little-endian conventions.

Figure 1-7. Misaligned Word Accessing (Little-Endian)

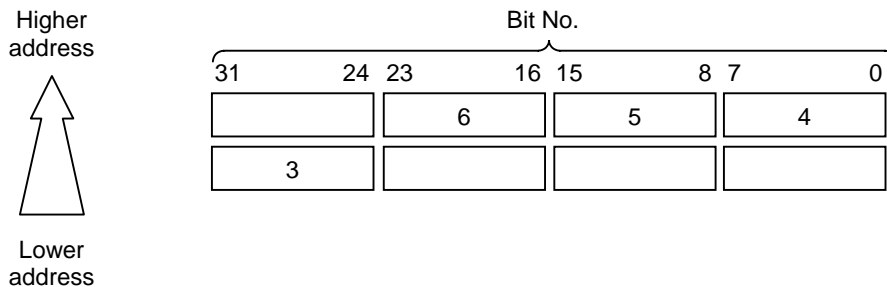

1.5.5 Coprocessors (CP0-CP3)

MIPS ISA defines 4 types of coprocessors (CP0 to CP3).

CP1 is reserved to execute a floating-point instruction. CP2 and CP3 are reserved for future use. CP0 is an on-chip system control coprocessor, which supports the virtual memory system and exception handling. The virtual memory system is implemented using an on-chip TLB and the CP0 registers in the CPU.

CP0 translates virtual addresses to physical addresses, switches the operating mode, (kernel, supervisor, or user mode), and management exceptions. It also controls the cache subsystem to analyze a cause and to return from the error state.

Figure 1-8 shows the definitions of the CP0 register, and Table 1-18 shows simple descriptions of each register. For the detailed descriptions of the registers related to the virtual system memory, refer to Chapter 5. For the detailed descriptions of the registers related to exception handling, refer to Chapter 6.

www.DataSheet4U.com

Figure 1-8. CP0 Registers

Register No.	Register name	Register No.	Register name
0	Index*	16	Config*
1	Random*	17	LLAddr*
2	EntryLo0*	18	WatchLo**
3	EntryLo1*	19	WatchHi**
4	Context**	20	XContext**
5	PageMask*	21	–
6	Wired*	22	–
7	–	23	–
8	BadVAddr**	24	–
9	Count**	25	–
10	EntryHi*	26	PErr**
11	Compare**	27	CacheErr**
12	Status**	28	TagLo*
13	Cause**	29	TagHi*
14	EPC**	30	ErrorEPC**
15	PRId*	31	–

- * for Memory management
- ** for Exception handling
- Reserved

Table 1-18. System Control Coprocessor (CP0) Register Definitions

Number	Register	Description
0	Index	Programmable pointer to TLB array
1	Random	Pseudo-random pointer to TLB array (read only)
2	EntryLo0	Low half of TLB entry for even VPN
3	EntryLo1	Low half of TLB entry for odd VPN
4	Context	Pointer to kernel virtual PTE in 32-bit mode
5	PageMask	TLB page mask
6	Wired	Number of wired TLB entries
7	—	Reserved for future use
8	BadVAddr	Virtual address where the most recent error occurred
9	Count	Timer count
10	EntryHi	High half of TLB entry (including ASID)
11	Compare	Timer compare
12	Status	Status register
13	Cause	Cause of last exception
14	EPC	Exception Program Counter
15	PRId	Processor revision identifier
16	Config	Configuration register (specifying memory mode system)
17	LLAddr	Reserved
18	WatchLo	Memory reference trap address low bits
19	WatchHi	Memory reference trap address high bits
20	XContext	Pointer to kernel virtual PTE in 64-bit mode
21 to 25	—	Reserved for future use
26	PErr	Cache parity bits
27	CacheErr	Index and status of cache error
28	TagLo	Cache Tag register (low)
29	TagHi	Cache Tag register (high)
30	ErrorEPC	Error Exception Program Counter
31	—	Reserved for future use

1.5.6 Floating-Point Unit (FPU)

The VR4102 does not support the floating-point unit (FPU). Coprocessor Unusable exception will occur if any FPU instructions are executed. If necessary, FPU instructions should be emulated by software in an exception handler.

1.5.7 Cache

The VR4102 chip incorporates instruction and data caches, which are independent of each other. This configuration enables high-performance pipeline operations. Both caches have a 64-bit data bus, enabling a one-clock access. These buses can be accessed in parallel. The instruction cache of the VR4102 has a storage capacity of 4 KB, while the data cache has a capacity of 1 KB.

A detailed description of caches is given in **CHAPETE 8 CACHE ORGANIZATION AND OPERATION**.

1.6 CPU CORE MEMORY MANAGEMENT SYSTEM (MMU)

The Vr4102 has a 32-bit physical addressing range of 4 Gbytes. However, since it is rare for systems to implement a physical memory space as large as that memory space, the CPU provides a logical expansion of memory space by translating addresses composed in the large virtual address space into available physical memory addresses. The Vr4102 supports the following two addressing modes:

32-bit mode, in which the virtual address space is divided into 2 Gbytes for user process and 2 Gbytes for the kernel.

64-bit mode, in which the virtual address is expanded to 1 Tbyte (2^{40} bytes) of user virtual address space.

www.DataSheet4U.com

A detailed description of these address spaces is given in Chapter 4.

1.6.1 Translation Lookaside Buffer (TLB)

The TLB converts virtual addresses to physical addresses. It runs by a full-associative method. It has 32 entries, each mapping a pair of pages having a variable size (1 KB to 256 KB).

(1) Joint TLB (JTLB)

For fast virtual-to-physical address decoding, the Vr4102 uses a large, fully associative TLB (joint TLB) that translates 64 virtual pages to their corresponding physical addresses. The TLB is organized as 32 pairs of even-odd entries, and maps a virtual address and address space identifier (ASID) into the 4-Gbyte physical address space.

The page size can be configured, on a per-entry basis, to map a page size of 1 KB to 256 KB. A CP0 register stores the size of the page to be mapped, and that size is entered into the TLB when a new entry is written. Thus, operating systems can provide special purpose maps; for example, a typical frame buffer can be memory-mapped using only one TLB entry.

Translating a virtual address to a physical address begins by comparing the virtual address from the processor with the physical addresses in the TLB; there is a match when the virtual page number (VPN) of the address is the same as the VPN field of the entry, and either the Global (G) bit of the TLB entry is set, or the ASID field of the virtual address is the same as the ASID field of the TLB entry.

This match is referred to as a TLB hit. If there is no match, a TLB Miss exception is taken by the processor and software is allowed to refill the TLB from a page table of virtual/physical addresses in memory.

1.6.2 Operating Modes

The Vr4102 has three operating modes:

- ✧ User mode
- ✧ Supervisor mode
- ✧ Kernel mode

The manner in which memory addresses are translated or mapped depends on these operating modes. Refer to **CHAPTER 5 MEMORY MANAGEMENT SYSTEM** for details.

1.7 INSTRUCTION PIPELINE

The V_R4102 has a 5-stage instruction pipeline. Under normal circumstances, one instruction is issued each cycle.

A detailed description of pipeline is provided in Chapter 4.

1.8 CLOCK INTERFACE

The V_R4102 has the following nine clocks.

❖ **CLKX1, CLKX2 (input)**

These are oscillation inputs of 18.432 MHz, and used to generate operation clocks for the CPU core and serial interface.

❖ **RTCX1, RTCX2 (input)**

These are oscillation inputs of 32.768 kHz, and used for PMU and RTC.

❖ **FIRCLK (input)**

This is a 48-MHz clock input, and used for FIR.

❖ **PClock (internal)**

This clock is used to control the pipeline used in the V_R4100 CPU core, and for units relating to the pipeline. This clock is generated from the clock input of CLKX1 and CLKX2 pins. Its frequency is determined by CLKSEL[2..0] pins.

❖ **MasterOut (internal)**

This is a bus clock of the V_R4100 CPU core, and used for interrupt control. Its frequency is 1/4 of PClock frequency.

❖ **TClock (internal)**

This is an operation clock for V_R4100 CPU core bus, internal bus of the V_R4102, and on-chip peripheral unit. In the current V_R4102, its frequency is 1/2 of PClock frequency.

❖ **BUSCLK (output)**

This clock is supplied to the controller on the system bus. Its frequency is determined by CLKSEL[2..0] pins.

❖ **HSPMCLK (output)**

This clock is supplied to the external CODEC. Its frequency is determined by the HSPMCLKD register.

❖ **HSPSCLK (input)**

This is an operation clock for the external CODEC and the modem interface.

Figure 1-9 shows an external circuit of the clock oscillator.

Figure 1-9. External Circuit of Clock Oscillator

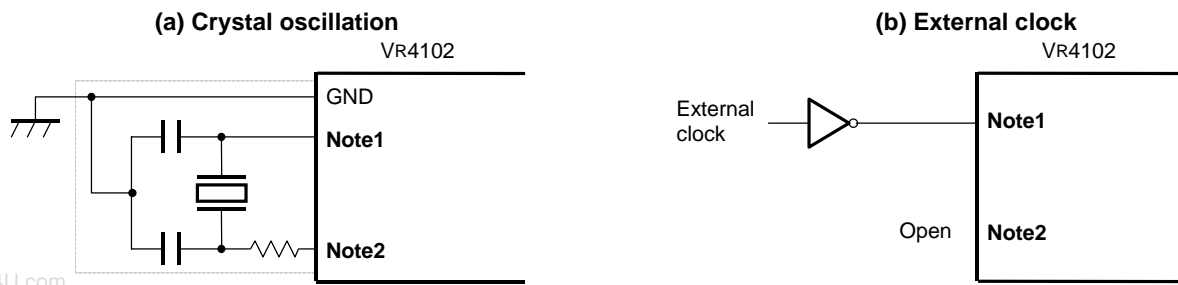

- Notes**
1. CLKX1, RTCX1
 2. CLKX2, RTCX2

Cautions 1. When using a clock oscillator, run wires in the area of this figure shown by broken lines, according to the following rules, to avoid effects such as stray capacitance:

- Minimize the wire.
- Never cause the wires to cross other signal lines or run near a line carrying a large varying current.
- Cause the grounding point of the capacitor of the oscillator circuit to have the same potential as GND. Never connect the capacitor to a ground pattern carrying a large current.
- Never extract a signal from the oscillator.

2. Take it into consideration that no load such as wiring capacity is applied to the CLKX2 or RTCX2 pin when inputting an external clock.

Figure 1-10 shows examples of oscillator having bad connection.

Figure 1-10. Examples of Oscillator with Bad Connection

(a) Connection circuit wiring is too long.

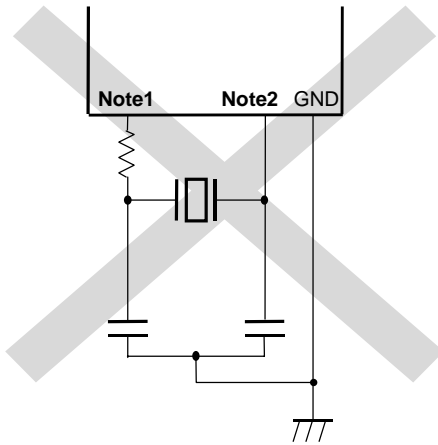

(b) There is another signal line crossing.

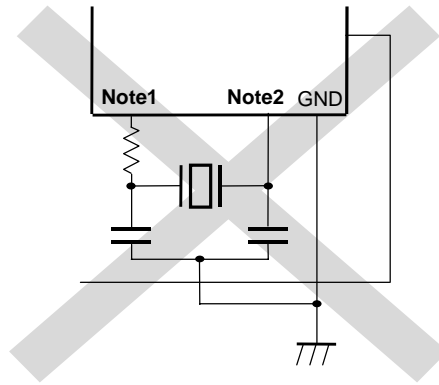

(c) A high varying current flows near a signal line.

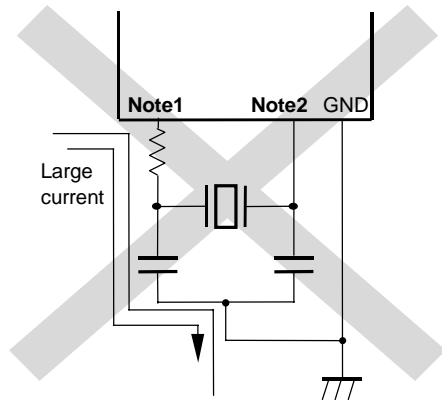

(d) A current flows over the ground line of the generator circuit (The potentials of points A, B, and C change).

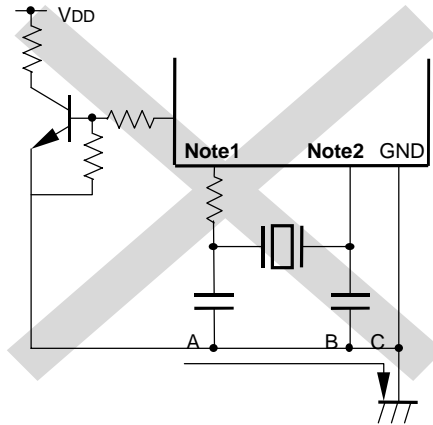

(e) A signal is extracted.

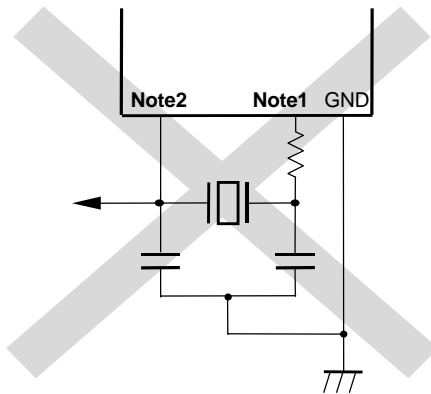

- Notes 1. CLKX2, RTCX2
- 2. CLKX1, RTCX1

[MEMO]

CHAPTER 2 PIN FUNCTIONS

2.1 PIN CONFIGURATION

- 216-pin plastic LQFP (fine-pitch) (24 × 24 mm) (Top View)

μPD30102GM-54-8EV

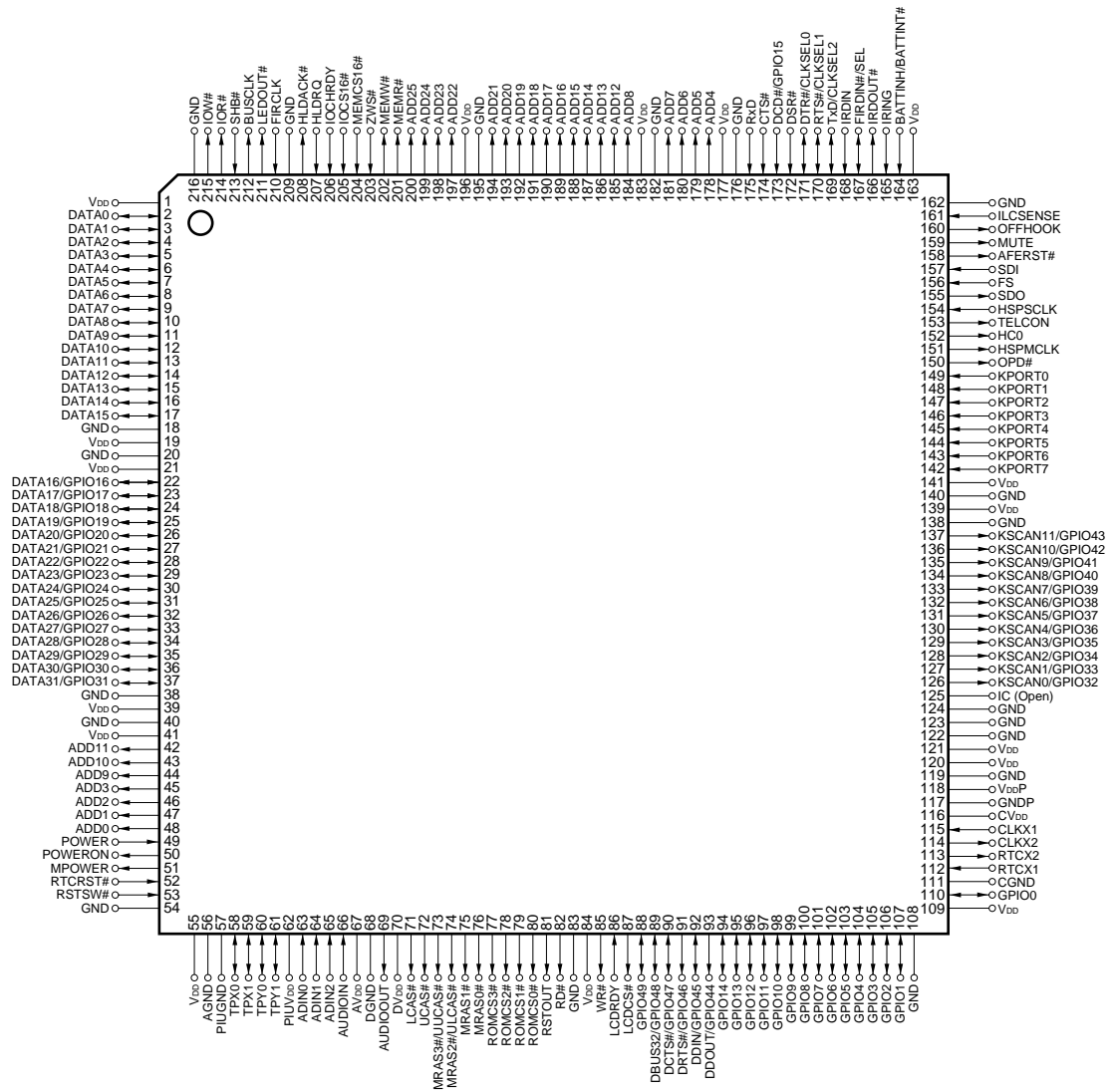

Remark # indicates active low.

- 224-pin plastic FGBA (16 × 16 mm)
 μ PD30102S1-54-3C

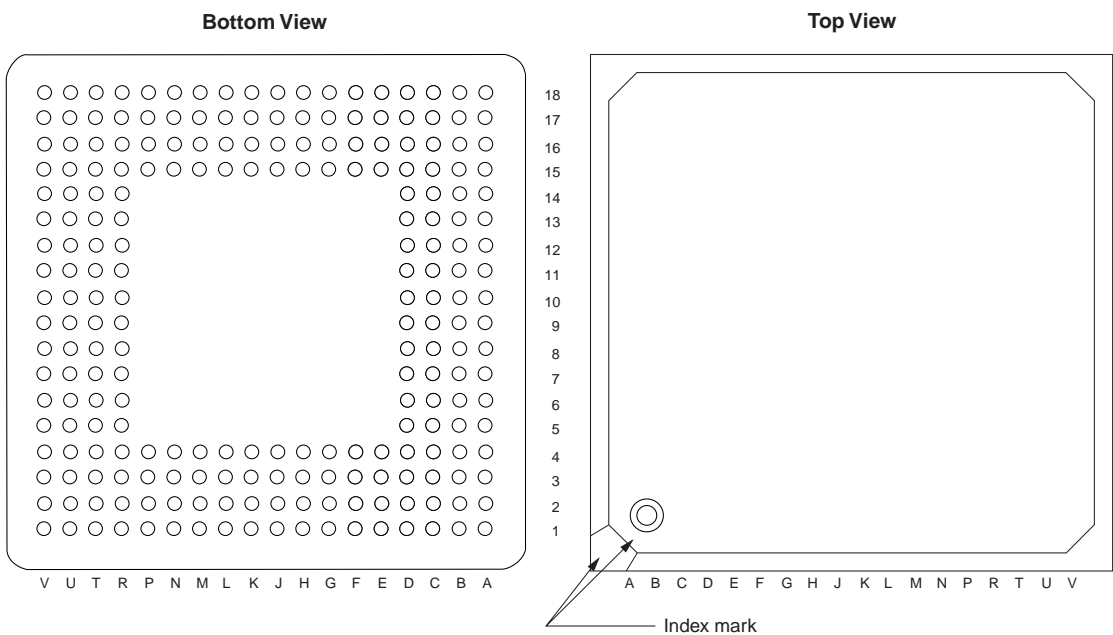

CHAPTER 2 PIN FUNCTIONS

Pin No.	Pin Name	Pin No.	Pin Name	Pin No.	Pin Name
A1	V _{DD}	C15	RTS#/CLKSEL1	H15	GND
A2	SHB#	C16	GND	H16	KPORT6
A3	BUSCLK	C17	ILCSENSE	H17	KPORT4
A4	HLDACK#	C18	AFERST#	H18	V _{DD}
A5	IOCHRDY	D1	DATA5	J1	DATA20/GPIO20
A6	MEMW#	D2	DATA3	J2	DATA17/GPIO17
A7	ADD23	D3	DATA6	J3	DATA22/GPIO22
A8	V _{DD}	D4	GND	J4	DATA19/GPIO19
A9	ADD18	D5	MEMCS16#	J15	KSCAN9/GPIO41
A10	ADD15	D6	ADD25	J16	V _{DD}
A11	ADD8	D7	GND	J17	GND
A12	ADD7	D8	ADD19	J18	KSCAN11/GPIO43
A13	V _{DD}	D9	ADD16	K1	DATA23/GPIO23
A14	DCD#/GPIO15	D10	ADD14	K2	DATA26/GPIO26
A15	TxD/CLKSEL2	D11	V _{DD}	K3	DATA25/GPIO25
A16	IRDOUT#	D12	GND	K4	DATA21/GPIO21
A17	IRING	D13	ADD4	K15	KSCAN7/GPIO39
A18	V _{DD}	D14	CTS#	K16	KSCAN10/GPIO42
B1	DATA1	D15	GND	K17	KSCAN5/GPIO37
B2	IOR#	D16	GND	K18	KSCAN8/GPIO40
B3	IOW#	D17	SDI	L1	DATA27/GPIO27
B4	LEDOUT#	D18	SDO	L2	DATA31/GPIO31
B5	FIRCLK	E1	DATA9	L3	DATA29/GPIO29
B6	HLDRQ#	E2	DATA4	L4	DATA24/GPIO24
B7	ZWS#	E3	DATA7	L15	KSCAN3/GPIO35
B8	ADD24	E4	DATA10	L16	KSCAN6/GPIO38
B9	ADD21	E15	OPD#	L17	KSCAN0/GPIO32
B10	ADD12	E16	HSPSCLK	L18	KSCAN4/GPIO36
B11	ADD6	E17	FS	M1	DATA30/GPIO30
B12	GND	E18	HC0	M2	V _{DD}
B13	DSR#	F1	DATA13	M3	GND
B14	IRDIN	F2	DATA8	M4	DATA28/GPIO28
B15	FIRDIN#/SEL	F3	DATA11	M15	KSCAN2/GPIO34
B16	BATTINH/BATTINT#	F4	DATA14	M16	IC (Open)
B17	OFFHOOK	F15	KPORT3	M17	GND
B18	MUTE	F16	HSPMCLK	M18	KSCAN1/GPIO33
C1	DATA2	F17	TELCON	N1	V _{DD}
C2	DATA0	F18	KPORT1	N2	ADD3
C3	GND	G1	V _{DD}	N3	ADD10
C4	GND	G2	DATA12	N4	GND
C5	GND	G3	DATA15	N15	GND
C6	IOCS16#	G4	GND	N16	V _{DD}
C7	MEMR#	G15	KPORT7	N17	V _{DDP}
C8	ADD22	G16	KPORT2	N18	GND
C9	ADD20	G17	KPORT0	P1	ADD9
C10	ADD17	G18	KPORT5	P2	ADD0
C11	ADD13	H1	DATA16/GPIO16	P3	ADD2
C12	ADD5	H2	GND	P4	ADD11
C13	RxD	H3	DATA18/GPIO18	P15	V _{DD}
C14	DTR#/CLKSEL0	H4	V _{DD}	P16	GNPD

CHAPTER 2 PIN FUNCTIONS

Pin No.	Pin Name	Pin No.	Pin Name	Pin No.	Pin Name
P17	CLKX2	T6	AV _{DD}	U13	GPIO9
P18	GND	T7	LCAS#	U14	GPIO6
R1	ADD1	T8	ROMCS2#	U15	GPIO5
R2	POWER	T9	RD#	U16	GPIO1
R3	GND	T10	WR#	U17	GPIO2
R4	GND	T11	DBUS32/GPIO48	U18	CGND
R5	AUDIOIN	T12	DDOUT#/GPIO44	V1	V _{DD}
R6	DV _{DD}	T13	GPIO11	V2	PIUGND
R7	MRAS2#/ULCAS#	T14	GPIO8	V3	TPX0
R8	MRAS1#	T15	GND	V4	TPY1
R9	ROMCS1#	T16	GND	V5	ADIN2
R10	RSTOUT	T17	GPIO0	V6	AUDIOOUT
R11	GND	T18	RTCX1	V7	MRAS3#/UUCAS#
R12	GPIO49	U1	MPOWER	V8	MRAS0#
R13	DDIN/GPIO45	U2	RTCRST#	V9	ROMCS0#
R14	GPIO12	U3	AGND	V10	V _{DD}
R15	GND	U4	TPX1	V11	LCDCS#
R16	CV _{DD}	U5	TPY0	V12	DCTS#/GPIO47
R17	RTCX2	U6	ADIN1	V13	GPIO14
R18	CLKX1	U7	DGND	V14	GPIO10
T1	POWERON	U8	UCAS#	V15	GPIO7
T2	RSTSW#	U9	ROMCS3#	V16	GPIO4
T3	GND	U10	LDCRDY	V17	GPIO3
T4	PIUV _{DD}	U11	DRTS#/GPIO46	V18	V _{DD}
T5	ADIN0	U12	GPIO13		

www.DataSheet4U.com

PIN IDENTIFICATION

ADD [0:25]	: Address Bus	IRDOUT#	: IrDA Data Output
ADIN [0:2]	: General Purpose Input for A/D	IRING	: Input Ring
AFERST#	: AFE Reset	KPORT [0:7]	: Key Code Data Input
AGND	: GND for A/D	KSCAN [0:11]	: Key Scan Line
AUDIOIN	: Audio Input	LCAS#	: Lower Column Address Strobe
AUDIOOUT	: Audio Output	LCDCS#	: LCD Chip Select
AVDD	: VDD for A/D	LCDRDY	: LCD Ready
BATTINH	: Battery Inhibit	LEDOUT#	: LED Output
BATTINT#	: Battery Interrupt Request	MEMCS16#	: Memory Chip Select 16
BUSCLK	: System Bus Clock	MEMR#	: Memory Read
CGND	: GND for Oscillator	MEMW#	: Memory Write
CLKSEL [0:2]	: Clock Select	MPOWER	: Main Power
CLKX1	: Clock X1	MRAS [0:3]#	: DRAM Row Address Strobe
CLKX2	: Clock X2	MUTE	: Mute
CTS#	: Clear to Send	OFFHOOK	: Off Hook
CVDD	: VDD for Oscillator	OPD#	: Output Power Down
DATA [0:31]	: Data Bus	PIUGND	: GND for Touch Panel Interface
DBUS32	: Data Bus 32	PIUVDD	: VDD for Touch Panel Interface
DCD#	: Data Carrier Detect	POWER	: Power Switch
DCTS#	: Debug Serial Clear to Send	POWERON	: Power On State
DDIN	: Debug Serial Data Input	RD#	: Read
DDOUT	: Debug Serial Data Output	ROMCS [0:3]#	: ROM Chip Select
DGND	: GND for D/A	RSTOUT	: System Bus Reset Output
DRTS#	: Debug Serial Request to Send	RSTSW#	: Reset Switch
DSR#	: Data Set Ready	RTCRST#	: Real-time Clock Reset
DTR#	: Data Terminal Ready	RTCX1	: Real-time Clock X1
DVDD	: VDD for D/A	RTCX2	: Real-time Clock X2
FIRCLK	: FIR Clock	RTS#	: Request to Send
FIRDIN#	: FIR Data Input	RxD	: Receive Data
FS	: Frame Synchronization	SDI	: HSP Serial Data Input
GND	: Ground	SDO	: HSP Serial Data Output
GNDP	: Ground for PLL	SEL	: IrDA Module Select
GPIO [0:49]	: General Purpose I/O	SHB#	: System Hi-Byte Enable
HC0	: Hardware Control 0	TELCON	: Telephone Control
HLDACK#	: Hold Acknowledge	TPX [0:1]	: Touch Panel X I/O
HLDRQ#	: Hold Request	TPY [0:1]	: Touch Panel Y I/O
HSPMCLK	: HSP Codec Master Clock	TxD	: Transmit Data
HSPSCLK	: HSP Codec Serial Clock	UCAS#	: Upper Column Address Strobe
IC	: Internally Connected	ULCAS#	: Lower Byte of Upper Column Address Strobe
ILCSENSE	: Input Loop Current Sensing	UUCAS#	: Upper Byte of Upper Column Address Strobe
IOCHRDY	: I/O Channel Ready	VDD	: Power Supply Voltage
IOCS16#	: I/O Chip Select 16	VDDP	: VDD for PLL
IOR#	: I/O Read	WR#	: Write
IOW#	: I/O Write	ZWS#	: Zero Wait State
IRDIN	: IrDA Data Input		

Remark # indicates active low.

2.2 PIN FUNCTION DESCRIPTION

The functional classification of the Vr4102 pins is listed below.

Remark # indicates active low.

Figure 2-1. Vr4102 Signal Classification

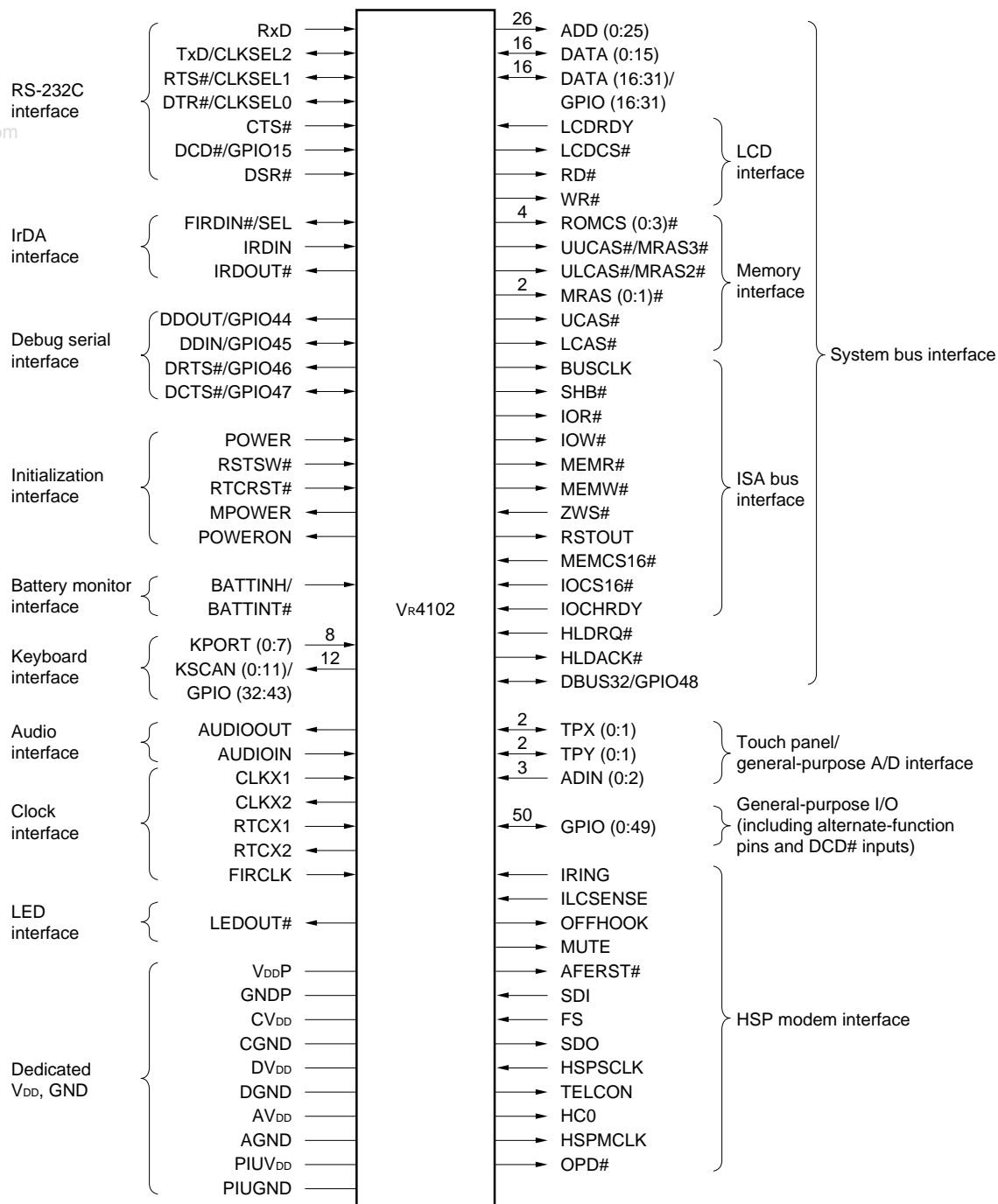

2.2.1 System Bus Interface Signals

These signals are used when the VR4102 is connected to a DRAM, ROM, or LCD, or other devices in the system through the system bus.

Table 2-1. System Bus Interface Signals (1/2)

Signal	I/O	Description of function
ADD[25..0]	O	This is a 26-bit address bus. The VR4102 uses this to specify addresses for the DRAM, ROM, LCD, or system bus (ISA).
DATA[15..0]	I/O	This is a 16-bit data bus. The VR4102 uses this to transmit and receive data with a DRAM, ROM, LCD, or system bus.
DATA[31..16]/ GPIO[31..16]	I/O	This function differs depending on how the DBUS32 pin is set. <When DBUS32 = 1> : DATA[31..16] It is the high-order 16 bits of the 32-bit data bus. This bus is used for transmitting and receiving data between the VR4102 and the DRAM and ROM. <When DBUS32 = 0> : GPIO[31..16] It is a general-purpose I/O (GPIO) port.
LDCS#	O	This is the LCD chip select signal. This signal is active when the VR4102 is performing LCD access using the ADD/DATA bus.
RD#	O	This is active when the VR4102 is reading data from the LCD, RAM, or ROM.
WR#	O	This is active when the VR4102 is writing data to the LCD, RAM, or ROM.
LCDRDY	I	This is the LCD ready signal. Set this signal as active when the LCD controller is ready to receive access from the VR4102.
ROMCS[3..0]#	O	This is the ROM chip select signal. It is used to select a ROM to be accessed from among up to four connected ROM units.
UUCAS#/ MRAS[3]#	O	This function differs depending on how the DBUS32 pin is set. <When DBUS32 = 1> : UUCAS# This signal is active when a valid column address is output via the ADD bus during access of DATA[31:24] in the 32-bit data bus. <When DBUS32 = 0> : MRAS[3]# This is the DRAM's RAS signal. Up to four DRAM units can be connected, and this signal is active when a valid row address is output via the ADD bus for the DRAM connected to the high-order address.
ULCAS#/ MRAS[2]#	O	This function differs depending on how the DBUS32 pin is set. <When DBUS32 = 1> ULCAS# This signal is active when a valid column address is output via the ADD bus during access of DATA[23:16] in the 32-bit data bus. <When DBUS32 = 0> MRAS[2]# This is the DRAM's RAS signal. This signal is active when a valid row address is output via the ADD bus for the DRAM connected to the next-highest address after the highest high-order address.
MRAS[1..0]#	O	This is the DRAM's RAS signal.
UCAS#	O	This is the DRAM's CAS signal. This signal is active when a valid column address is output via the ADD bus during access of DATA[15:8] in the DRAM.
LCAS#	O	This is the DRAM's CAS signal. This signal is active when a valid column address is output via the ADD bus during access of DATA[7:0] in the DRAM.

Table 2-1. System Bus Interface Signals (2/2)

Signal	I/O	Description of function
BUSCLK	O	This is the system bus clock. It is used to output the clock that is supplied to the controller on the system bus. Its frequency is determined by the state of the CLKSEL2/TxD, CLKSEL1/RTS#, and CLKSEL0/DTR pins. (See 2.2.5 RS-232-C Interface Signals.)
SHB#	O	This is the system bus high-byte enable signal. During system bus access, this signal is active when the high-order byte is valid on the data bus.
IOR#	O	This is the system bus I/O read signal. It is active when the Vr4102 accesses the system bus to read data from an I/O port.
IOW#	O	This is the system bus I/O write signal. It is active when the Vr4102 accesses the system bus to write data to an I/O port.
MEMR#	O	This is the system bus memory read signal. It is active when the Vr4102 accesses the system bus to read data from memory.
MEMW#	O	This is the system bus memory write signal. It is active when the Vr4102 accesses the system bus to write data to memory.
ZWS#	I	This is the system bus zero wait state signal. Set this signal as active to enable the controller on the system bus to be accessed by the Vr4102 without a wait interval.
RSTOUT	O	This is the system bus reset signal. It is active when the Vr4102 resets the system bus controller.
MEMCS16#	I	This is a dynamic bus sizing request signal. Set this signal as active when system bus memory accesses data in 16-bit width. (However, the DRAM bus memory space that is controlled by the DBUS 32 pin is excepted.)
IOCS16#	I	This is a dynamic bus sizing request signal. Set this signal as active when system bus I/O accesses data in 16-bit width.
IOCHRDY	I	This is the system bus ready signal. Set this signal as active when the system bus controller is ready to be accessed by the Vr4102.
HLDRQ#	I	This is a hold request signal for the system bus and DRAM bus that is sent from an external bus master.
HLDAK#	O	This is a hold acknowledge signal for the system bus and DRAM bus that is sent to an external bus master.
DBUS32/ GPIO[48]	I/O	This function differs depending on the operating status. <ul style="list-style-type: none"> In normal operation (output) It can be used as a general-purpose output port. After RTC reset (input) It is a data bus width switching signal. Sampling occurs when the RTCRST signal changes from low to high. <p>1 : Use 32-bit width for data bus 0 : Use 16-bit width for data bus</p>

2.2.2 Clock Interface Signals

These signals are used to supply clocks. Table 2-2 lists functions of these signals.

Table 2-2. Clock Interface Signals

Signal	I/O	Description of function
RTCX1	I	This is the 32.768-kHz oscillator's input pin. It is connected to one side of a crystal resonator.
RTCX2	O	This is the 32.768-kHz oscillator's output pin. It is connected to one side of a crystal resonator.
CLKX1	I	This is the 18.432-MHz oscillator's input pin. It is connected to one side of a crystal resonator.
CLKX2	O	This is the 18.432-MHz oscillator's output pin. It is connected to one side of a crystal resonator.
FIRCLK	I	This the 48-MHz clock input pin. Fix this at high level when FIR is not used.

2.2.3 Battery Monitor Interface Signals

These signals indicate when an external agent is able to provide enough power for system operations. Table 2-3 describes the functions of these signals.

Table 2-3. Battery Monitor Interface Signals

Signal	I/O	Description of function
BATTINH/ BATTINT#	I	<p>This function differs depending on how the MPOWER pin is set.</p> <p><When MPOWER = 0> BATTINH function This is an interrupt signal that is output when remaining power is low while battery is ON. The external agent checks the remaining battery power and asserts the signal at this pin if the supplied voltage is sufficient for current operations. 1 : Battery OK 0 : Battery low</p> <p><When MPOWER = 1> BATTINT# function This is an interrupt signal that is output when remaining power is low during normal operations. The external agent checks the remaining battery power and asserts the signal at this pin if voltage sufficient for operations cannot be supplied.</p>

2.2.4 Initialization Interface Signals

These signals are used when an external agent initializes the processor operation parameters. Table 2-4 describes the functions of these signals.

Table 2-4 Initialization Interface Signals

Signal	I/O	Description of function
MPOWER	O	This signal is used to turn on the main power source. The VR4102 asserts the signal at this pin to turn on the power source for the external DC/DC converter.
POWERON	O	This signal indicates when the VR4102 is ready to operate. It becomes active when a power-on factor is detected and becomes inactive when the BATTINH/BATTINT# signal check operation is completed.
POWER	I	This signal indicates that the POWER ON switch has been pressed. When the POWER ON switch has been pressed, an external agent must assert the signal at this pin.
RSTSW#	I	This signal indicates that the RESET switch has been pressed. When the RESET switch has been pressed, an external agent must assert the signal at this pin.
RTCST#	I	This signal resets the RTC. When power is first supplied to a device, the external agent must assert the signal at this pin for about 600 ms.

2.2.5 RS-232-C Interface Signals

These signals control data transmission and reception between the VR4102 and an RS-232-C controller. Table 2-5 describes the functions of these signals.

Table 2-5. RS-232-C Interface Signals

Signal	I/O	Description of function																											
RxD	I	This is a receive data signal. It is used when the RS-232-C controller sends serial data to the VR4102.																											
CTS#	I	This is the transmit enable (“clear-to-send”) signal. This signal is asserted when the RS-232-C controller is ready to receive transmission of serial data.																											
DCD#/ GPIO[15]	I	This is a carrier detection signal. This signal is asserted when valid serial data is being received. It is also used when detecting a power-on factor for the VR4102. When this pin is not used for DCD# signal, this pin can be used as an interrupt detection function for the GIU unit.																											
DSR#	I	This is the data set ready signal. Assert this signal to set up transmission and reception of serial data between the RS-232C controller and the Vr4102.																											
TxD/ CLKSEL[2], RTS#/ CLKSEL[1], DTR#/ CLKSEL[0]	I/O	<p>This function differs depending on the operating status.</p> <ul style="list-style-type: none"> In normal operation (output) <ul style="list-style-type: none"> TxD signal (output): This is a transmit data signal. It is used when the VR4102 sends serial data to the RS-232C controller. RTS# signal (output): This is a transmit request signal. This signal is asserted when the VR4102 is ready to receive serial data from the RS-232C controller. DTR# signal (output): This is a terminal equipment ready signal. This signal is asserted when the VR4102 is ready to transmit or receive serial data. After RTC reset (input) <ul style="list-style-type: none"> These signals are used to set the CPU core operation and BUSCLK frequency (CLKSEL[2..0]: input). Sampling occurs when the RTCRST signal changes from low to high. <table border="1"> <thead> <tr> <th>CLKSEL[2..0]</th> <th>CPU Core frequency</th> <th>BUSCLK frequency</th> </tr> </thead> <tbody> <tr> <td>111</td> <td>RFU</td> <td>RFU</td> </tr> <tr> <td>110</td> <td>RFU</td> <td>RFU</td> </tr> <tr> <td>101</td> <td>53.6 MHz</td> <td>6.700 MHz</td> </tr> <tr> <td>100</td> <td>49.2 MHz</td> <td>6.075 MHz</td> </tr> <tr> <td>011</td> <td>45.4 MHz</td> <td>5.675 MHz</td> </tr> <tr> <td>010</td> <td>42.1 MHz</td> <td>5.275 MHz</td> </tr> <tr> <td>001</td> <td>36.9 MHz</td> <td>9.200 MHz</td> </tr> <tr> <td>000</td> <td>32.8 MHz</td> <td>8.200 MHz</td> </tr> </tbody> </table> <p>Caution Some of these settings of frequency may not be able to select in the future.</p>	CLKSEL[2..0]	CPU Core frequency	BUSCLK frequency	111	RFU	RFU	110	RFU	RFU	101	53.6 MHz	6.700 MHz	100	49.2 MHz	6.075 MHz	011	45.4 MHz	5.675 MHz	010	42.1 MHz	5.275 MHz	001	36.9 MHz	9.200 MHz	000	32.8 MHz	8.200 MHz
CLKSEL[2..0]	CPU Core frequency	BUSCLK frequency																											
111	RFU	RFU																											
110	RFU	RFU																											
101	53.6 MHz	6.700 MHz																											
100	49.2 MHz	6.075 MHz																											
011	45.4 MHz	5.675 MHz																											
010	42.1 MHz	5.275 MHz																											
001	36.9 MHz	9.200 MHz																											
000	32.8 MHz	8.200 MHz																											

2.2.6 IrDA Interface Signals

These signals are used to control data transmission and reception between the VR4102 and an IrDA controller. Table 2-6 describes the functions of these signals.

Table 2-6. IrDA Interface Signals

Signal	I/O	Description of function
IRDIN	I	This is the IrDA serial data input signal. It is used when the VR4102 sends serial data to the IrDA controller, for both FIR and SIR. If the IrDA controller used is an HP product, however, this signal should be used for only SIR.
FIRDIN#/SEL	I/O	This function differs according to the IrDA controller used (for how to switch a controller, refer to 24.2.13). <ul style="list-style-type: none"> HP's controller FIRDIN#: It is a FIR receive data input signal. TEMIC's controller SEL: It is an output port for external FIR/SIR switching. SHARP's controller Use is prohibited.
IRDOUT#	O	This is the IrDA serial data output signal for both SIR and FIR. It is used when the IrDA controller sends serial data to the VR4102.

2.2.7 Debug Serial Interface Signals

These signals are used to control data transmission and reception between the VR4102 and a external debug serial controller. Table 2-7 describes the functions of these signals.

Table 2-7. Debug Serial Interface Signals

Signal	I/O	Description of function
DDOUT/ GPIO[44]	O	This is the debug serial data output signal. It is used when an external debug serial data controller sends serial data to the VR4102. When this pin is not used for the DDOUT signal, it can be used as a general-purpose output port.
DDIN/ GPIO[45]	I/O	This is the debug serial data input signal. It is used when the VR4102 sends serial data to an external debug serial controller. When this pin is not used for the DDIN signal, it can be used as a general-purpose output port.
DRTS#/ GPIO[46]	O	This is a transmission request signal. The VR4102 asserts this signal before sending serial data. When this pin is not used for the DRTS# signal, it can be used as a general-purpose output port.
DCTS#/ GPIO[47]	I/O	This is a transmit acknowledge signal. The VR4102 asserts this signal when it is ready to receive transmitted serial data. When this pin is not used for the DCTS# signal, it can be used as a general-purpose output port.

2.2.8 Keyboard Interface Signals

These signals are used to control a keyboard circuit to the VR4102. Table 2-8 describes the functions of these signals.

Table 2-8. Keyboard Interface Signals

Signal	I/O	Description of function
KPORT[7..0]	I	This is a keyboard scan data input signal. It is used to scan for pressed keys on the keyboard.
KSCAN[11..0]/ GPIO[43..32]	O	These signal are used as keyboard scan data output signals and a general-purpose output port. The scan line is set as active when scanning for pressed keys on the keyboard. Pins that are not used for the key scan operation can be used as a general-purpose output port.

2.2.9 Audio Interface Signals

This signal is used to input/output audio signals. Table 2-9 describes the functions of this signal.

Table 2-9. Audio Interface Signals

Signal	I/O	Description of function
AUDIOOUT	O	This is an audio output signal. Analog signals that have been converted via the on-chip 10-bit D/A converter are output.
AUDIOIN	I	This pin is the audio input pin.

2.2.10 Touch Panel/General Purpose A/D Interface Signals

These are the signals to the on-chip A/D converter of the VR4102. Four of these signals are used for a touch panel, one is used for audio input, and the remaining three are used as general-purpose pins. Table 2-10 describes the functions of these signals.

Table 2-10. Touch Panel/General Purpose A/D Interface Signals

Signal	I/O	Description of function
TPX[1..0]	I/O	This is an I/O signal that is used for the touch panel. It uses the voltage applied to the X coordinate and the voltage input to the Y coordinate to detect which coordinates on the touch panel are being pressed.
TPY[1..0]	I/O	This is an I/O signal that is used for the touch panel. It uses the voltage applied to the Y coordinate and the voltage input to the X coordinate to detect which coordinates on the touch panel are being pressed.
ADIN[2..0]	I	This is a general-purpose A/D input signal.

2.2.11 General-purpose I/O Signals

These are general-purpose I/O pins of the VR4102. Ordinary, 33 of the 49 GPIO pins are used as alternate-function pins. Table 2-11 describes the functions of these signals.

Table 2-11. General-purpose I/O Signals

Signal	I/O	Description of function
GPIO[3..0]	I/O	These are maskable power-on factors. After start-up, they are used as ordinary GPIO pins.
GPIO[8..4]	I/O	These are ordinary GPIO pins.
GPIO[12..9]	I/O	These are maskable power-on factors. After start-up, they are used as ordinary GPIO pins.
GPIO[14..13]	I/O	These are ordinary GPIO pins.
DATA[31..16]/ GPIO[31..16]	I/O	See 2.2.1 System Bus Interface Signals .
KSCAN[11..0]/ GPIO[43..32]	O	See 2.2.8 Keyboard Interface Signals .
DDOUT/ GPIO[44]	O	See 2.2.7 Debug Serial Interface Signals .
DDIN/GPIO[45]	I/O	See 2.2.7 Debug Serial Interface Signals .
DRTS#/ GPIO[46]	O	See 2.2.7 Debug Serial Interface Signals .
DCTS#/ GPIO[47]	I/O	See 2.2.7 Debug Serial Interface Signals .
DBUS32/ GPIO[48]	I/O	See 2.2.1 System Bus Interface Signals .
GPIO[49]	I/O	This function differs depending on the operating status. <ul style="list-style-type: none"> • In normal operation It can be used as a general-purpose output port. • After RTC reset Input state. Input low level. Sampling occurs when the RTCRST signal changes from low to high.

2.2.12 HSP MODEM Interface Signals

Table 2-12. HSP MODEM Interface Signals

Signal	I/O	Function
IRING	I	RING signal detect signal. This pin becomes active when the RING signal is detected.
ILCSENSE	I	Handset detect signal.
OFFHOOK	O	On-hook relay control signal.
MUTE	O	Modem speaker mute control signal.
AFERST#	O	CODEC reset signal.
SDI	I	Serial input signal from CODEC.
FS	I	Frame synchronization signal from CODEC.
SDO	O	Serial output signal to CODEC.
HSPSCLK	I	Operation clock input of modem interface block for CODEC.
TELCON	O	Handset relay control signal.
HCO	O	CODEC control signal.
HSPMCLK	O	Clock output to CODEC.
OPD#	O	Use this pin for controlling power of CODEC and DAA. This signal is set as active when to set power supply to them ON.

2.2.13 LED Interface Signal

Table 2-13. LED Interface Signal

Signal	I/O	Description of function
LEDOUT#	O	This is an output signal for lighting LEDs.

2.2.14 Dedicated V_{DD} and GND SignalsTable 2-14. Dedicated V_{DD} and GND Signals

Signal	Description of function
V _{DDP}	This is the dedicated V _{DD} for the PLL.
GNDP	This is the dedicated GND for the PLL.
CV _{DD}	This is the dedicated V _{DD} for the internal oscillator.
CGND	This is the dedicated GND for the internal oscillator.
DV _{DD}	This is the dedicated V _{DD} for the D/A converter. The voltage applied to this pin becomes the maximum value for AUDIOOUT's analog output.
DGND	This is the dedicated GND for the D/A converter. The voltage applied to this pin becomes the minimum value for AUDIOOUT's analog output.
AV _{DD}	This is the dedicated V _{DD} for the A/D converter. The voltage applied to this pin becomes the maximum voltage value for the A/D interface signals.
AGND	This is the dedicated GND for the A/D converter. The voltage applied to this pin becomes the minimum voltage value detectable by the A/D interface signals.
PIUV _{DD}	This is the dedicated V _{DD} for the touch panel interface.
PIUGND	This is the dedicated GND for the touch panel interface.

2.3 PIN STATUS UPON SPECIFIC STATES

2.3.1 Pin Status upon Reset

Table 2-15. Status of Pins upon Reset (1/3)

Signal	When reset by RTCRST	When reset by Deadman's Switch or RSTSW	During Suspend mode	During Hibernate mode or when shut down by HAL timer	During bus hold
ADD[25..0]	0	0	Note 1	0	Hi-Z
DATA[15..0]	0	0	Note 1	0	Hi-Z
DATA[31..16]/ GPIO[31..16]	0/ Hi-Z	0/ Hi-Z	Note 1	0/ Hi-Z	Hi-Z/ Note 1
LCDCS#	Hi-Z	1	1	Hi-Z	1
RD#	Hi-Z	1	1	Hi-Z	Hi-Z
WR#	Hi-Z	1	1	Hi-Z	Hi-Z
LCDRDY	–	–	–	–	–
ROMCS[3..0]#	Hi-Z	1	1	Hi-Z	1
UUCAS#/MRAS[3] #	1	Note 3	0	0	Hi-Z
ULCAS#/MRAS[2]#	1	Note 3	0	0	Hi-Z
MRAS[1..0]#	1	Note 3	0	0	Hi-Z
UCAS#	1	Note 3	0	0	Hi-Z
LCAS#	1	Note 3	0	0	Hi-Z
BUSCLK	0	0	0	0	Note 2
SHB#	Hi-Z	1	1	Hi-Z	Hi-Z
IOR#	Hi-Z	1	1	Hi-Z	Hi-Z
IOW#	Hi-Z	1	1	Hi-Z	Hi-Z
MEMR#	Hi-Z	1	1	Hi-Z	Hi-Z
MEMW#	Hi-Z	1	1	Hi-Z	Hi-Z
ZWS#	–	–	–	–	–
RSTOUT	Hi-Z	1	0	Hi-Z	Note 4
IOCS16#	–	–	–	–	–
MEMCS16#	–	–	–	–	–
IOCHRDY	–	–	–	–	–

- Notes**
1. The state at the previous Fullspeed mode is retained.
 2. Bus hold from Suspend mode: Outputs the low-level signal
Bus hold from Fullspeed mode or standby mode: Outputs clocks.
 3. Reset by RSTSW# signal: This pin outputs the low-level signal (self refresh)
Reset by Deadman's Switch: This pin outputs the high-level signal
 4. Normal operations are performed.

Remark 0: outputs low level, 1: outputs high level, Hi-Z: high-impedance

Table 2-15. Status of Pins upon Reset (2/3)

Signal	When reset by RTCRST	When reset by Deadman's Switch or RSTSW	During Suspend mode	During Hibernate mode or when shut down by HAL timer	During bus hold
HLDQR#	–	–	–	–	–
HLDACK#	Hi-Z	1	Note 1	Hi-Z	Note 1
RTCX1	–	–	–	–	–
RTCX2	–	–	–	–	–
CLKX1	–	–	–	–	–
CLKX2	–	–	–	–	–
FIRCLK	–	–	–	–	–
BATTINH/ BATTINT#	–	–	–	–	–
MPOWER	0	1	1	0	1
POWERON	0	0	0	0	0
POWER	–	–	–	–	–
RSTSW#	–	–	–	–	–
RTCRST#	–	–	–	–	–
RxD	–	–	–	–	–
TxD/CLKSEL[2]	Hi-Z	1	1	1	Note 1
RTS#/CLKSEL[1]	Hi-Z	1	1	1	Note 1
CTS#	–	–	–	–	–
DCD#/GPIO[15]	–	–	–	–	–
DTR#/CLKSEL[0]	Hi-Z	1	1	1	Note 1
DSR#	–	–	–	–	–
IRDIN	–	–	–	–	–
IRDOUT#	0	0	0	0	Note 1
FIRDIN#/SEL	Hi-Z	Hi-Z	Note 2	Hi-Z	Note 2
DDIN/ GPIO[45] ^{Note3}	Hi-Z/ Hi-Z	Hi-Z/ Hi-Z	Hi-Z/ Note 2	Hi-Z/ Hi-Z	Hi-Z/ Note 2
DDOUT/ GPIO[44] ^{Note3}	1	1	1	1	1
DRTS#/ GPIO[46] ^{Note3}	1	1	1	1	1
DCTS#/ GPIO[47] ^{Note3}	Hi-Z/ Hi-Z	Hi-Z/ Hi-Z	Hi-Z/ Note 2	Hi-Z/ Hi-Z	Hi-Z/ Note 2

- Notes 1.** Normal operations are performed.
2. The state at the previous Fullspeed mode is retained.
3. This pin can be switched by software between function-pin and output-port uses.

Remark 0: outputs low level, 1: outputs high level, Hi-Z: high-impedance

Table 2-15. Status of Pins upon Reset (3/3)

Signal	When reset by RTCRST	When reset by Deadman's Switch or RSTSW	During Suspend mode	During Hibernate mode or when shut down by HAL timer	During bus hold
KPORT[7..0]	–	–	–	–	–
KSCAN[11..0]/ GPIO[43..32] ^{Note 1}	Hi-Z	Hi-Z	Note 2	Hi-Z	Note 3
AUDIOOUT	0	0	Note 2	0	Note 3
TPX[1..0]	Hi-Z	1	Note 2	1	Note 3
TPY[1..0]	Hi-Z	Hi-Z	Note 2	Hi-Z	Note 3
ADIN[2..0]	–	–	–	–	–
AUDIOIN	–	–	–	–	–
GPIO[14..0]	Hi-Z	Hi-Z	Note 2	Hi-Z	Note 3
IRING	–	–	–	–	–
ILCSENSE	–	–	–	–	–
OFFHOOK ^{Note 4}	Hi-Z	Hi-Z	Note 2	Hi-Z	Note 2
MUTE ^{Note 4}	Hi-Z	Hi-Z	Note 2	Hi-Z	Note 2
AFERST# ^{Note 4}	0	0	Note 2	0	Note 2
SDI	–	–	–	–	–
FS	–	–	–	–	–
SDO	0	0	Note 2	0	Note 2
HSPSCLK	–	–	–	–	–
TELCON ^{Note 4}	Hi-Z	Hi-Z	Note 2	Hi-Z	Note 2
HCO ^{Note 4}	0	0	Note 2	0	Note 2
HSPMCLK ^{Note 4}	0	0	Note 2	0	Note 2
OPD#	0	0	Note 2	0	Note 2
LEDOUT#	1	Note 3	Note 3	Note 3	Note 3
DBUS32/ GPIO[48] ^{Note 5}	Hi-Z	Hi-Z	Note 2	Hi-Z	Note 2
GPIO[49] ^{Note 5}	Hi-Z	Hi-Z	Note 2	Hi-Z	Note 2

- Notes**
1. This pin can be switched by software between function-pin and output-port uses.
 2. The state at the previous Fullspeed mode is retained.
 3. Normal operations are performed.
 4. Be sure to set the BSC bit (DI) of the HSPINT register (0x0C00 0020) to 1 during initialization.
 5. After RTC reset is canceled, this signal functions as an output port.

Remark 0: outputs low level, 1: outputs high level, Hi-Z: high-impedance

2.3.2 Connection of Unused Pins and Pin I/O Circuits

Table 2-16. Connection of Unused Pins and Pin I/O Circuit Type (1/3)

Signal	Internal processing	External processing	Drive capability	I/O circuit type
ADD[25..0]	–	–	120 pF	A
DATA[15..0]	–	–	40 pF	A
DATA[31..16]/ GPIO[31..16]	–	– / Pull up Pull down	40 pF	A
LDCS#	–	–	40 pF	A
RD#	–	Note 1	120 pF	A
WR#	–	Note 1	120 pF	A
LCDRDY	–	Pull up	–	A
ROMCS[3..0]#	–	–	40 pF	A
UUCAS#/MRAS[3]#	–	Note 1	40 pF	A
ULCAS#/MRAS[2]#	–	Note 1	40 pF	A
MRAS[1..0]#	–	Note 1	40 pF	A
UCAS#	–	Note 1	40 pF	A
LCAS#	–	Note 1	40 pF	A
BUSCLK	–	–	40 pF	A
SHB#	–	Note 1	40 pF	A
IOR#	–	Note 1	40 pF	A
IOW#	–	Note 1	40 pF	A
MEMR#	–	Note 1	40 pF	A
MEMW#	–	Note 1	40 pF	A
ZWS#	Note 2	Pull up	–	A
RSTOUT	–	Pull up	40 pF	A
IOCS16#	Note 2	Pull up	–	A
MEMCS16#	Note 2	Pull up	–	A
IOCHRDY	Note 2	Pull up	–	A

Notes 1. Pull up when the bus hold function is used.

2. Intermediate-level input is enabled when the MPOWER pin is set for low-level output.

Table 2-16. Connection of Unused Pins and Pin I/O Circuit Type (2/3)

Signal	Internal processing	External processing	Drive capability	I/O circuit type
HLDRQ#	Note 1	Note 2	–	A
HLDAK#	–	–	40 pF	A
RTCX1	–	Resonator	–	–
RTCX2	–	Resonator	–	–
CLKX1	–	Resonator	–	–
CLKX2	–	Resonator	–	–
FIRCLK	–	Note 3	–	A
BATTINH/ BATTINT#	Schmitt	–	–	B
MPOWER	–	–	40 pF	A
POWERON	–	–	40 pF	A
POWER	Schmitt	–	–	B
RSTSW#	Schmitt	–	–	B
RTCST#	Schmitt	–	–	B
RxD	–	–	–	A
TxD/CLKSEL[2]	–	Pull up Pull down	40 pF	A
RTS#/CLKSEL[1]	–	Pull up Pull down	40 pF	A
CTS#	–	–	–	A
DCD#/GPIO[15]	–	Pull up	–	A
DTR#/CLKSEL[0]	–	Pull up Pull down	40 pF	A
DSR#	–	–	–	A
IRDIN	–	Pull up	–	A
IRDOUT#	–	–	40 pF	A
FIRDIN#/SEL	–	Pull up Pull down	40 pF	A
DDIN/ GPIO[45] ^{Note 4}	–	–	40 pF	A
DDOUT/ GPIO[44] ^{Note 4}	–	–	40 pF	A
DRTS#/ GPIO[46] ^{Note 4}	–	–	40 pF	A
DCTS#/ GPIO[47] ^{Note 4}	–	–	40 pF	A

- Notes**
- Intermediate-level input is enabled when the MPOWER pin is set for low-level output.
 - When the bus hold function is used : Pull up.
When the bus hold function is not used : Connect to V_{DD}.
 - When FIR unit is used : Attach an oscillator.
When FIR unit is not used : Connect to V_{DD}.
 - This pin can be switched by software between function-pin and output-port uses.

Table 2-16. Connection of Unused Pins and Pin I/O Circuit Type (3/3)

Signal	Internal processing	External processing	Drive capability	I/O circuit type
KPORT[7..0]	Schmitt, Pull down	–	–	F
KSCAN[11..0]/ GPIO[43..32] ^{Note 1}	–	–	40 pF	A
AUDIOOUT	–	Note 2	–	G
TPX[1..0]	–	–	120 pF or more	C
TPY[1]	–	–	120 pF or more	D
TPY[0]	–	–	120 pF or more	C
ADIN[2..0]	–	–	–	E
AUDIOIN	–	–	–	E
GPIO[14..13]	–	Pull up Pull down	40 pF	A
GPIO[12..9]	Schmitt	Pull up Pull down	40 pF	B
GPIO[8..5]	–	Pull up Pull down	40 pF	A
GPIO[4..0]	Schmitt	Pull up Pull down	40 pF	B
IRING	Schmitt	Pull down	–	B
ILCSENSE	–	Pull down	–	A
OFFHOOK ^{Note 3}	–	–	40 pF	A
MUTE ^{Note 3}	–	–	40 pF	A
AFERST# ^{Note 3}	–	–	40 pF	A
SDI	–	Pull up Pull down	–	A
FS	–	Pull up Pull down	–	A
SDO	–	–	40 pF	A
HSPSCLK	–	–	–	A
TELCON ^{Note 3}	–	–	40 pF	A
HCO ^{Note 3}	–	–	40 pF	A
HSPMCLK ^{Note 3}	–	–	40 pF	A
OPD#	–	–	40 pF	A
LEDOUT#	–	–	40 pF	A
DBUS32/ GPIO[48] ^{Note 4}	–	Pull up Pull down	40 pF	A
GPIO[49] ^{Note 4}	–	Pull down	–	A

- Notes**
1. This pin can be switched by software between function-pin and output-port uses.
 2. Connect an operation amplifier which has high-impedance input characteristics, since the output level of AUDIOOUT pin varies according to the external impedance.
 3. Be sure to set BSC bit (DI) of the HSPINT register (0x0C00 0020) to 1 during initialization.
 4. After RTC reset is canceled, this signal functions as an output port.

2.3.3 Pin I/O Circuits

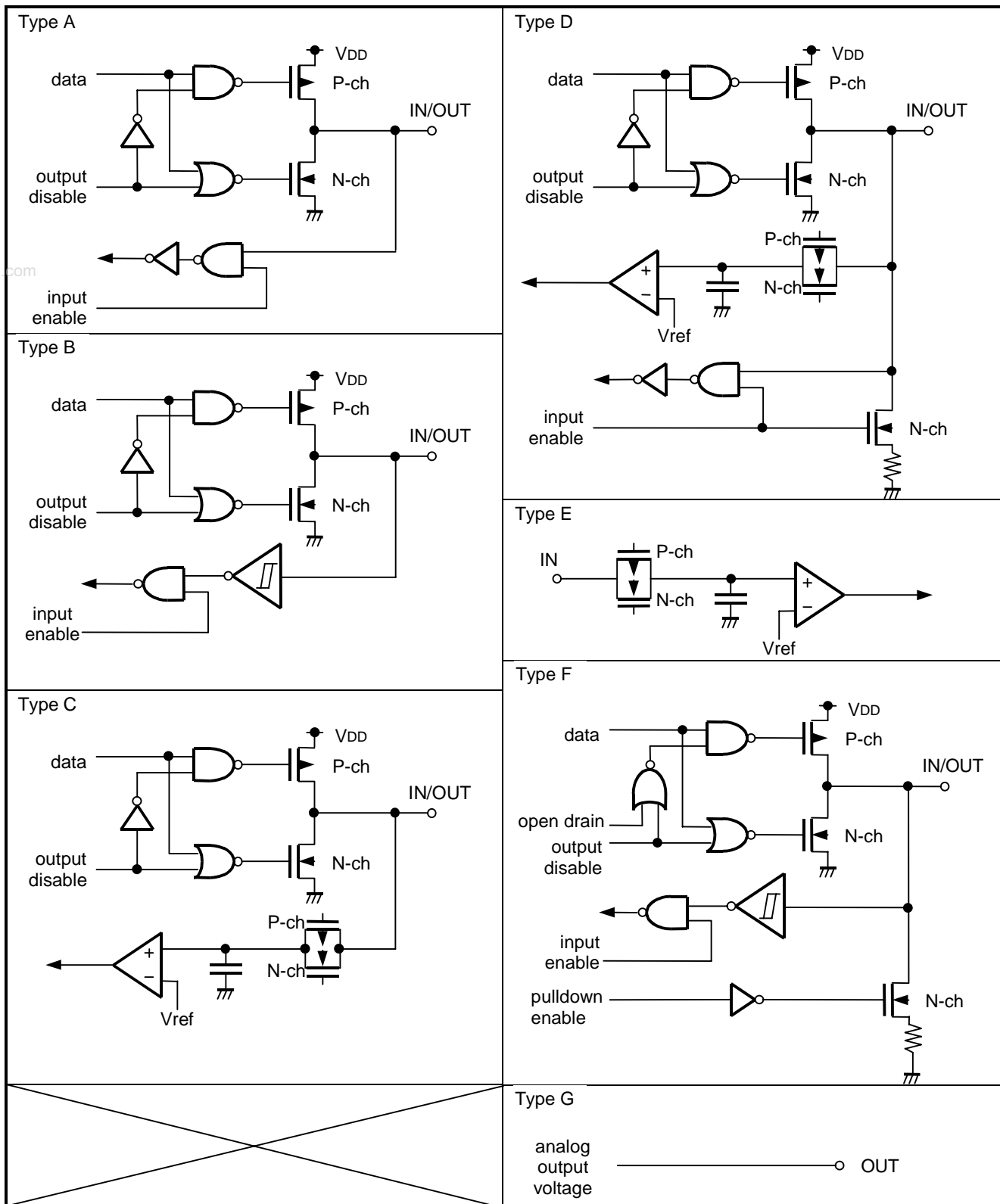

[MEMO]

CHAPTER 3 CPU INSTRUCTION SET SUMMARY

This chapter is an overview of the central processing unit (CPU) instruction set; refer to the Chapter 27 for detailed descriptions of individual CPU instructions.

3.1 CPU INSTRUCTION FORMATS

Each CPU instruction consists of a single 32-bit word, aligned on a word boundary. There are three instruction formats - immediate (I-type), jump (J-type), and register (R-type) - as shown in Figure 3-1. The use of a small number of instruction formats simplifies instruction decoding, allowing the compiler to synthesize more complicated and less frequently used instruction and addressing modes from these three formats as needed.

Figure 3-1. CPU Instruction Formats

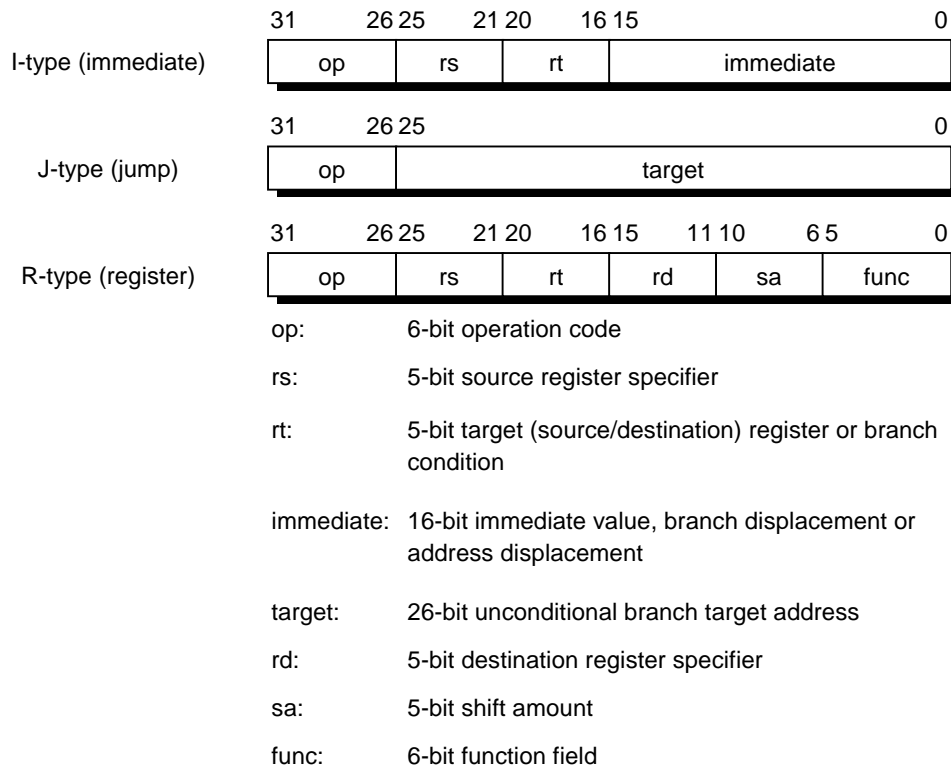

(1) Support of the MIPS ISA

The VR4102 does not support a multiprocessor operating environment. Thus the synchronization support instructions defined in the MIPS II and MIPS III ISA - the load linked and store conditional instructions - cause reserved instruction exception. The load/link (LL) bit is eliminated.

Note that the SYNC instruction is handled as a NOP instruction since all load/store instructions in this processor are executed in program order.

3.2 INSTRUCTION CLASSES

3.2.1 Load and Store Instructions

Load and store are immediate (I-type) instructions that move data between memory and the general-purpose registers. The only addressing mode that load and store instructions directly support is base register plus 16-bit signed immediate offset.

(1) Scheduling a Load Delay Slot

A load instruction that does not allow its result to be used by the instruction immediately following is called a delayed load instruction. The instruction slot immediately following this delayed load instruction is referred to as the load delay slot.

In the VR4000 Series, a load instruction can be followed directly by an instruction that accesses a register that is loaded by the load instruction. In this case, however, an interlock occurs for a necessary number of cycles. Any instruction can follow a load instruction, but the load delay slot should be scheduled appropriately for both performance and compatibility with the VR3000™ Series microprocessors. For detail, see **CHAPTER 4 VR4102 PIPELINE**.

(2) Store Delay Slot

When a store instruction is writing data to a cache, the data cache is kept busy at the DC and WB stages. If an instruction (such as load) that follows directly the store instruction accesses the data cache in the DC stage, a hardware-driven interlock occurs. To overcome this problem, the store delay slot should be scheduled.

Table 3-1. Number of Delay Slot Cycles Necessary for Load and Store Instructions

Instruction	Necessary number of PCycles
Load	1
Store	1

(3) Defining Access Types

Access type indicates the size of a VR4102 processor data item to be loaded or stored, set by the load or store instruction opcode. Access types and accessed byte are shown in Table 3-2.

Regardless of access type or byte ordering (endianness), the address given specifies the low-order byte in the addressed field. For a little-endian configuration, the low-order byte is the least-significant byte.

The access type, together with the three low-order bits of the address, define the bytes accessed within the addressed doubleword (shown in Table 3-2). Only the combinations shown in Table 3-2 are permissible; other combinations cause address error exceptions.

Tables 3-3 and 3-4 list the ISA-defined load/store instructions and expand-ISA instructions, respectively.

Figure 3-2. Byte Specification Related to Load and Store Instructions

Access type (value)	Low-order address bit			Accessed byte (Little endian)									
	2	1	0	63									0
Doubleword (7)	0	0	0	7	6	5	4	3	2	1	0		
7-byte (6)	0	0	0		6	5	4	3	2	1	0		
	0	0	1	7	6	5	4	3	2	1			
6-byte (5)	0	0	0			5	4	3	2	1	0		
	0	1	0	7	6	5	4	3	2				
5-byte (4)	0	0	0				4	3	2	1	0		
	0	1	1	7	6	5	4	3					
Word (3)	0	0	0					3	2	1	0		
	1	0	0	7	6	5	4						
Triple byte (2)	0	0	0						2	1	0		
	0	0	1					3	2	1			
	1	0	0		6	5	4						
	1	0	1	7	6	5							
Halfword (1)	0	0	0							1	0		
	0	1	0					3	2				
	1	0	0			5	4						
	1	1	0	7	6								
Byte (0)	0	0	0										0
	0	0	1								1		
	0	1	0						2				
	0	1	1					3					
	1	0	0				4						
	1	0	1			5							
	1	1	0		6								
	1	1	1	7									

www.DataSheet4U.

Table 3-2. Load/store Instruction

Instruction	Format and Description				
		op	base	rt	offset
Load Byte	LB rt, offset (base) The offset is sign extended and then added to the contents of the register base to form the virtual address. The bytes of the memory location specified by the address are sign extended and loaded into register rt.				
Load Byte Unsigned	LBU rt, offset (base) The offset is sign extended and then added to the contents of the register base to form the virtual address. The bytes of the memory location specified by the address are zero extended and loaded into register rt.				
Load Halfword	LH rt, offset (base) The offset is sign extended and then added to the contents of the register base to form the virtual address. The halfword of the memory location specified by the address is sign extended and loaded to register rt.				
Load Halfword Unsigned	LHU rt, offset (base) The offset is sign extended and then added to the contents of the register base to form the virtual address. The halfword of the memory location specified by the address is zero extended and loaded to register rt.				
Load Word	LW rt, offset (base) The offset is sign extended and then added to the contents of the register base to form the virtual address. The word of the memory location specified by the address is sign extended and loaded to register rt. In the 64-bit mode, it is further sign extended to 64 bits.				
Load Word Left	LWL rt, offset (base) The offset is sign extended and then added to the contents of the register base to form the virtual address. Shifts to the left the word whose address is specified so that the address-specified byte is at the left-most position of the word. The result of the shift operation is merged with the contents of register rt and loaded to register rt. In the 64-bit mode, it is further sign extended to 64 bits.				
Load Word Right	LWR rt, offset (base) The offset is sign extended and then added to the contents of the register base to form the virtual address. Shifts to the right the word whose address is specified so that the address-specified byte is at the right-most position of the word. The result of the shift operation is merged with the contents of register rt and loaded to register rt. In the 64-bit mode, it is further sign extended to 64 bits.				
Store Byte	SB rt, offset (base) The offset is sign extended and then added to the contents of the register base to form the virtual address. The least significant byte of register rt is stored to the memory location specified by the address.				
Store Halfword	SH rt, offset (base) The offset is sign extended and then added to the contents of the register base to form the virtual address. The least significant halfword of register rt is stored to the memory location specified by the address.				
Store Word	SW rt, offset (base) The offset is sign extended and then added to the contents of the register base to form the virtual address. The lower word of register rt is stored to the memory location specified by the address.				
Store Word Left	SWL rt, offset (base) The offset is sign extended and then added to the contents of the register base to form the virtual address. Shifts to the right the contents of register rt so that the left-most byte of the word is in the position of the address-specified byte. The result is stored to the lower word in memory.				
Store Word Right	SWR rt, offset (base) The offset is sign extended and then added to the contents of the register base to form the virtual address. Shifts to the left the contents of register rt so that the right-most byte of the word is in the position of the address-specified byte. The result is stored to the upper word in memory.				

Table 3-3. Load/store Instruction (Extended ISA)

Instruction	Format and Description				
		op	base	rt	offset
Load Doubleword	LD rt, offset (base) The offset is sign extended and then added to the contents of the register base to form the virtual address. The doubleword of the memory location specified by the address are loaded into register rt.				
Load Doubleword Left	LDL rt, offset (base) The offset is sign extended and then added to the contents of the register base to form the virtual address. Shifts to the left the double word whose address is specified so that the address-specified byte is at the left-most position of the double word. The result of the shift operation is merged with the contents of register rt and loaded to register rt.				
Load Doubleword Right	LDR rt, offset (base) The offset is sign extended and then added to the contents of the register base to form the virtual address. Shifts to the right the double word whose address is specified so that the address-specified byte is at the right-most position of the double word. The result of the shift operation is merged with the contents of register rt and loaded to register rt.				
Load Word Unsigned	LWU rt, offset (base) The offset is sign extended and then added to the contents of the register base to form the virtual address. The word of the memory location specified by the address are zero extended and loaded into register rt				
Store Doubleword	SD rt, offset (base) The offset is sign extended and then added to the contents of the register base to form the virtual address. The contents of register rt are stored to the memory location specified by the address.				
Store Doubleword Left	SDL rt, offset (base) The offset is sign extended and then added to the contents of the register base to form the virtual address. Shifts to the right the contents of register rt so that the left-most byte of the double word is in the position of the address-specified byte. The result is stored to the lower doubleword in memory.				
Store Doubleword Right	SDR rt, offset (base) The offset is sign extended and then added to the contents of the register base to form the virtual address. Shifts to the left the contents of register rt so that the right-most byte of the double word is in the position of the address-specified byte. The result is stored to the upper doubleword in memory.				

3.2.2 Computational Instructions

Computational instructions perform arithmetic, logical, and shift operations on values in registers. Computational instructions can be either in register (R-type) format, in which both operands are registers, or in immediate (I-type) format, in which one operand is a 16-bit immediate.

Computational instructions are classified as:

- (1) ALU immediate instructions (Tables 3-4 and 3-5)
- (2) Three-operand type instructions (Tables 3-6 and 3-7)
- (3) Shift instructions (Tables 3-8 and 3-9)
- (4) Multiply/divide instructions (Table 3-10 and 3-11)

www.DataSheet4U.com

To maintain data compatibility between the 64- and 32-bit modes, it is necessary to sign-extend 32-bit operands correctly. If the sign extension is not correct, the 32-bit operation result is meaningless.

Table 3-4. ALU Immediate Instruction

Instruction	Format and Description				
		op	rs	rt	immediate
Add Immediate	ADDI rt, rs, immediate The 16-bit immediate is sign extended and then added to the contents of register rs to form a 32-bit result. The result is stored into register rt. In the 64-bit mode, the operand must be sign extended. An exception occurs on the generation of 2's complement overflow.				
Add Immediate Unsigned	ADDIU rt, rs, immediate The 16-bit immediate is sign extended and then added to the contents of register rs to form a 32-bit result. The result is stored into register rt. In the 64-bit mode, the operand must be sign extended. No exception occurs on the generation of integer overflow.				
Set On Less Than Immediate	SLTI rt, rs, immediate The 16-bit immediate is sign extended and then compared to the contents of register rt treating both operands as signed integers. If rs is less than the immediate, the result is set to 1; otherwise, the result is set to 0. The result is stored to register rt.				
Set On Less Than Immediate Unsigned	SLTIU rt, rs, immediate The 16-bit immediate is sign extended and then compared to the contents of register rt treating both operands as unsigned integers. If rs is less than the immediate, the result is set to 1; otherwise, the result is set to 0. The result is stored to register rt.				
And Immediate	ANDI rt, rs, immediate The 16-bit immediate is zero extended and then ANDed with the contents of the register. The result is stored into register rt.				
Or Immediate	ORI rt, rs, immediate The 16-bit immediate is zero extended and then ORed with the contents of the register. The result is stored into register rt.				
Exclusive Or Immediate	XORI rt, rs, immediate The 16-bit immediate is zero extended and then Ex-ORed with the contents of the register. The result is stored into register rt.				
Load Upper Immediate	LUI rt, immediate The 16-bit immediate is shifted left by 16 bits to set the lower 16 bits of word to 0. The result is stored into register rt. In the 64-bit mode, the operand must be sign extended.				

Table 3-5. ALU Immediate Instruction (Extended ISA)

Instruction	Format and Description				
		op	rs	rt	immediate
Doubleword Add Immediate	DADDI rt, rs, immediate The 16-bit immediate is sign extended to 64 bits and then added to the contents of register rs to form a 64-bit result. The result is stored into register rt. An exception occurs on the generation of integer overflow.				
Doubleword Add Immediate Unsigned	DADDIU rt, rs, immediate The 16-bit immediate is sign extended to 64 bits and then added to the contents of register rs to form a 64-bit result. The result is stored into register rt. No exception occurs on the generation of overflow.				

www.DataSheet4U.com

Table 3-6. Three Operand Type Instruction

Instruction	Format and Description						
		op	rs	rt	rd	sa	funct
Add	ADD rd, rs, rt The contents of registers rs and rt are added together to form a 32-bit result. The result is stored into register rd. In the 64-bit mode, the operand must be sign extended. An exception occurs on the generation of integer overflow.						
Add Unsigned	ADDU rd, rs, rt The contents of registers rs and rt are added together to form a 32-bit result. The result is stored into register rd. In the 64-bit mode, the operand must be sign extended. No exception occurs on the generation of integer overflow.						
Subtract	SUB rd, rs, rt The contents of register rt are subtracted from the contents of register rs. The 32-bit result is stored into register rd. In the 64-bit mode, the operand must be sign extended. An exception occurs on the generation of integer overflow.						
Subtract Unsigned	SUBU rd, rs, rt The contents of register rt are subtracted from the contents of register rs. The 32-bit result is stored into register rd. In the 64-bit mode, the operand must be sign extended. No exception occurs on the generation of integer overflow.						
Set On Less Than	SLT rd, rs, rt The contents of registers rs and rt are compared, treating both operands as signed integers. If the contents of register rs is less than that of register rt, the result is set to 1; otherwise, the result is set to 0. The result is stored to register rd.						
Set On Less Than Unsigned	SLTU rd, rs, rt The contents of registers rs and rt are compared treating both operands as unsigned integers. If the contents of register rs is less than that of register rt, the result is set to 1; otherwise, the result is set to 0. The result is stored to register rd.						
And	AND rd, rt, rs The contents of register rs are logical ANDed with that of general register rt bit-wise. The result is stored to register rd.						
Or	OR rd, rt, rs The contents of register rs are logical ORed with that of general register rt bit-wise. The result is stored to register rd.						
Exclusive Or	XOR rd, rt, rs The contents of register rs are logical Ex-ORed with that of general register rt bit-wise. The result is stored to register rd.						
Nor	NOR rd, rt, rs The contents of register rs are logical NORed with that of general register rt bit-wise. The result is stored to register rd.						

Table 3-7. Three Operand Type Instruction (Extended ISA)

Instruction	Format and Description						
		op	rs	rt	rd	sa	funct
Doubleword Add	DADD rd, rt, rs The contents of register rs are added to that of register rt. The 64-bit result is stored into register rd. An exception occurs on the generation of integer overflow.						
Doubleword Add Unsigned	DADDU rd, rt, rs The contents of register rs are added to that of register rt. The 64-bit result is stored into register rd. No exception occurs on the generation of integer overflow.						
Doubleword Subtract	DSUB rd, rt, rs The contents of register rt are subtracted from that of register rs. The 64-bit result is stored into register rd. An exception occurs on the generation of integer overflow.						
Doubleword Subtract Unsigned	DSUBU rd, rt, rs The contents of register rt are subtracted from that of register rs. The 64-bit result is stored into register rd. No exception occurs on the generation of integer overflow.						

Table 3-8. Shift Instruction

Instruction	Format and Description						
		op	rs	rt	rd	sa	funct
Shift Left Logical	SLL rd, rs, sa The contents of register rt are shifted left by sa bits and zeros are inserted into the emptied lower bits. The 32-bit result is stored into register rd. In the 64-bit mode, the operand must be sign extended.						
Shift Right Logical	SRL rd, rs, sa The contents of register rt are shifted right by sa bits and zeros are inserted into the emptied higher bits. The 32-bit result is stored into register rd. In the 64-bit mode, the operand must be sign extended.						
Shift Right Arithmetic	SRA rd, rt, sa The contents of register rt are shifted right by sa bits and the emptied higher bits are sign extended. The 32-bit result is stored into register rd. In the 64-bit mode, the operand must be sign extended.						
Shift Left Logical Variable	SLLV rd, rt, rs The contents of register rt are shifted left and zeros are inserted into the emptied lower bits. The lower five bits of register rs specify the shift count. The 32-bit result is stored into register rd. In the 64-bit mode, the operand must be sign extended.						
Shift Right Logical Variable	SRLV rd, rt, rs The contents of register rt are shifted right and zeros are inserted into the emptied higher bits. The lower five bits of register rs specify the shift count. The 32-bit result is stored into register rd. In the 64-bit mode, the operand must be sign extended.						
Shift Right Arithmetic Variable	SRAV rd, rt, rs The contents of register rt are shifted right and the emptied higher bits are sign extended. The lower five bits of register rs specify the shift count. The 32-bit result is stored into register rd. In the 64-bit mode, the operand must be sign extended.						

Table 3-9. Shift Instruction (Extended ISA)

Instruction	Format and Description						
		op	rs	rt	rd	sa	funct
Doubleword Shift Left Logical	DSLL rd, rs, sa The contents of register rt are shifted left by sa bits and zeros are inserted into the emptied lower bits. The 64-bit result is stored into register rd.						
Doubleword Shift Right Logical	DSRL rd, rs, sa The contents of register rt are shifted right by sa bits and zeros are inserted into the emptied higher bits. The 64-bit result is stored into register rd.						
Doubleword Shift Right Arithmetic	DSRA rd, rt, sa The contents of register rt are shifted right by sa bits and the emptied higher bits are sign extended. The 64-bit result is stored into register rd.						
Doubleword Shift Left Logical Variable	DSLLV rd, rt, rs The contents of register rt are shifted left and zeros are inserted into the emptied lower bits. The lower six bits of register rs specify the shift count. The 64-bit result is stored into register rd.						
Doubleword Shift Right Logical Variable	DSRLV rd, rt, rs The contents of register rt are shifted right and zeros are inserted into the emptied higher bits. The lower six bits of register rs specify the shift count. The 64-bit result is stored into register rd.						
Doubleword Shift Right Arithmetic Variable	DSRAV rd, rt, rs The contents of register rt are shifted right and the emptied higher bits are sign extended. The lower six bits of register rs specify the shift count. The 64-bit result is stored into register rd.						
Doubleword Shift Left Logical + 32	DSLL32 rd, rt, sa The contents of register rt are shifted left by 32 + sa bits and zeros are inserted into the emptied lower bits. The 64-bit result is stored into register rd.						
Doubleword Shift Right Logical + 32	DSRL32 rd, rt, sa The contents of register rt are shifted right by 32 + sa bits and zeros are inserted into the emptied higher bits. The 64-bit result is stored into register rd.						
Doubleword Shift Right Arithmetic + 32	DSRA32 rd, rt, sa The contents of register rt are shifted right by 32 + sa bits and the emptied higher bits are sign extended. The 64-bit result is stored into register rd.						

Table 3-10. Multiply/Divide Instructions

Instruction	Format and Description						
		op	rs	rt	rd	sa	funct
Multiply	MULT rs, rt The contents of registers rt and rs are multiplied, treating both operands as 32-bit signed integers. The 64-bit result is stored into special registers HI and LO. In the 64-bit mode, the operand must be sign extended.						
Multiply Unsigned	MULTU rs, rt The contents of registers rt and rs are multiplied, treating both operands as 32-bit unsigned integers. The 64-bit result is stored into special registers HI and LO. In the 64-bit mode, the operand must be sign extended.						
Divide	DIV rs, rt The contents of register rs are divided by that of register rt, treating both operands as 32-bit signed integers. The 32-bit quotient is stored into special register LO, and the 32-bit remainder is stored into special register HI. In the 64-bit mode, the operand must be sign extended.						
Divide Unsigned	DIVU rs, rt The contents of register rs are divided by that of register rt, treating both operands as 32-bit unsigned integers. The 32-bit quotient is stored into special register LO, and the 32-bit remainder is stored into special register HI. In the 64-bit mode, the operand must be sign extended.						
Move From HI	MFHI rd The contents of special register HI are loaded into register rd.						
Move From LO	MFLO rd The contents of special register LO are loaded into register rd.						
Move To HI	MTHI rs The contents of register rs are loaded into special register HI.						
Move To LO	MTLO rs The contents of register rs are loaded into special register LO.						

Table 3-11. Multiply/Divide Instructions (Extended ISA) (1/2)

Instruction	Format and Description						
		op	rs	rt	rd	sa	funct
Doubleword Multiply	DMULT rs, rt The contents of registers rt and rs are multiplied, treating both operands as signed integers. The 128-bit result is stored into special registers HI and LO.						
Doubleword Multiply Unsigned	DMULTU rs, rt The contents of registers rt and rs are multiplied, treating both operands as unsigned integers. The 128-bit result is stored into special registers HI and LO.						
Doubleword Divide	DDIV rs, rt The contents of register rs are divided by that of register rt, treating both operands as signed integers. The 64-bit quotient is stored into special register LO, and the 64-bit remainder is stored into special register HI.						
Doubleword Divide Unsigned	DDIVU rs, rt The contents of register rs are divided by that of register rt, treating both operands as unsigned integers. The 64-bit quotient is stored into special register LO, and the 64-bit remainder is stored into special register HI.						

Table 3-11. Multiply/Divide Instructions (Extended ISA) (2/2)

Instruction	Format and Description						
		op	rs	rt	rd	sa	funct
Multiply and Add 16-bit Integer	MADD16 rs, rt The contents of registers rt and rs are multiplied, treating both operands as 16-bit signed integers (by sign extending to 64 bits). The result is added to the combined value of special registers HI and LO. The 64-bit result is stored into special registers HI and LO.						
Doubleword Multiply and Add 16-bit Integer	DMADD16 rs, rt The contents of registers rt and rs are multiplied, treating both operands as 16-bit signed integers (by sign extending to 64 bits). The result is added to value of special register LO. The 64-bit result is stored into special register LO.						

www.DataSheet4U.com

MFHI and MFLO instructions after a multiply or divide instruction generate interlocks to delay execution of the next instruction, inhibiting the result from being read until the multiply or divide instruction completes.

Table 3-12 gives the number of processor cycles (PCycles) required to resolve interlock or stall between various multiply or divide instructions and a subsequent MFHI or MFLO instruction.

Table 3-12. Number of Stall Cycles in Multiply and Divide Instructions

Instruction	Number of instruction cycles
MULT	1
MULTU	1
DIV	35
DIVU	35
DMULT	4
DMULTU	4
DDIV	67
DDIVU	67
MADD16	1
DMADD16	1

3.2.3 Jump and Branch Instructions

Jump and branch instructions change the control flow of a program. All jump and branch instructions occur with a delay of one instruction: that is, the instruction immediately following the jump or branch instruction (this is known as the instruction in the delay slot) always executes while the target instruction is being fetched from memory.

For instructions involving a link (such as JAL and BLTZAL), the return address is saved in register r31.

Table 3-13. Number of Delay Slot Cycles in Jump and Branch Instructions

Instruction	Necessary number of cycles
Branch instruction	1
Jump instruction	1

www.DataSheet4U.com

(1) Overview of jump instructions

Subroutine calls in high-level languages are usually implemented with J or JAL instructions, both of which are J-type instructions. In J-type format, the 26-bit target address shifts left 2 bits and combines with the high-order 4 bits of the current program counter to form a 32-bit or 64-bit absolute address.

Returns, dispatches, and cross-page jumps are usually implemented with the JR or JALR instructions. Both are R-type instructions that take the 32-bit or 64-bit byte address contained in one of the general-purpose registers. For more information, refer to Chapter 27.

(2) Overview of branch instructions

A branch instruction has a PC-related signed 16-bit offset.

Tables 3-14 through 3-16 show the lists of Jump, Branch, and Extended ISA instructions, respectively.

Table 3-14. Jump Instruction

Instruction	Format and Description	op	target
Jump	J target The contents of 26-bit target address is shifted left by two bits and combined with the high-order four bits of the PC. The program jumps to this calculated address with a delay of one instruction.		
Jump And Link	JAL target The contents of 26-bit target address is shifted left by two bits and combined with the high-order four bits of the PC. The program jumps to this calculated address with a delay of one instruction. The address of the instruction following the delay slot is stored into r31 (link register).		

Instruction	Format and Description	op	rs	rt	rd	sa	funct
Jump Register	JR rs The program jumps to the address specified in register rs with a delay of one instruction.						
Jump And Link Register	JALR rs, rd The program jumps to the address specified in register rs with a delay of one instruction. The address of the instruction following the delay slot is stored into rd.						

There are the following common restrictions for Tables 3-15 and 3-16.

(1) Branch address

All branch instruction target addresses are computed by adding the address of the instruction in the delay slot to the 16-bit offset (shifted left by 2 bits and sign-extended to 64 bits). All branches occur with a delay of one instruction.

(2) Operation when unbranched

If the branch condition does not meet in executing a Likely instruction, the instruction in its delay slot is nullified. For all other branch instructions, the instruction in its delay slot is unconditionally executed.

Remark The target instruction of the branch is fetched at the EX stage of the branch instruction. Comparison of the operands of the branch instruction and calculation of the target address is performed at phase 2 of the RF stage and phase 1 of the EX stage of the instruction. Branch instructions require one cycle of the branch delay slot defined by the architecture. Jump instructions also require one cycle of delay slot. If the branch condition is not satisfied in a branch likely instruction, the instruction in its delay slot is nullified.

There are special symbols used in the instruction formats of Tables 3-15 through 3-19.

- REGIMM : Opcode
- Sub : Sub-operation code
- CO : Sub-operation identifier
- BC : BC sub-operation code
- br : Branch condition identifier
- op : Operation code

Table 3-15. Branch Instructions

Instruction	Format and Description				
		op	rs	rt	offset
Branch On Equal	BEQ rs, rt, offset If the contents of register rs are equal to that of register rt, the program branches to the target address.				
Branch On Not Equal	BNE rs, rt, offset If the contents of register rs are not equal to that of register rt, the program branches to the target address.				
Branch On Less Than Or Equal To Zero	BLEZ rs, offset If the contents of register rs are less than or equal to zero, the program branches to the target address.				
Branch On Greater Than Zero	BGTZ rs, offset If the contents of register rs are greater than zero, the program branches to the target address.				

Instruction	Format and Description				
		REGIMM	rs	sub	offset
Branch On Less Than Zero	BLTZ rs, offset If the contents of register rs are less than zero, the program branches to the target address.				
Branch On Greater Than Or Equal To Zero	BGEZ rs, offset If the contents of register rs are greater than or equal to zero, the program branches to the target address.				
Branch On Less Than Zero And Link	BLTZAL rs, offset The address of the instruction that follows delay slot is stored to register r31 (link register). If the contents of register rs are less than zero, the program branches to the target address.				
Branch On Greater Than Or Equal To Zero And Link	BGEZAL rs, offset The address of the instruction that follows delay slot is stored to register r31 (link register). If the contents of register rs are greater than or equal to zero, the program branches to the target address.				

Instruction	Format and Description				
		COP0	BC	br	offset
Branch On Coprocessor 0 True	BC0T offset Adds the 16-bit offset (shifted left by two bits and sign extended to 32 bits) to the address of the instruction in the delay slot to calculate out the branch target address. If the conditional signal of the coprocessor 0 is true, the program branches to the target address with one-instruction delay.				
Branch On Coprocessor 0 False	BC0F offset Adds the 16-bit offset (shifted left by two bits and sign extended to 32 bits) to the address of the instruction in the delay slot to calculate out the branch target address. If the conditional signal of the coprocessor 0 is false, the program branches to the target address with one-instruction delay.				

Table 3-16. Branch Instructions (Extended ISA)

Instruction	Format and Description				
		op	rs	rt	offset
Branch On Equal Likely	BEQL rs, rt, offset If the contents of register rs are equal to that of register rt, the program branches to the target address. If the branch condition is not met, the instruction in the delay slot is discarded.				
Branch On Not Equal Likely	BNEL rs, rt, offset If the contents of register rs are not equal to that of register rt, the program branches to the target address. If the branch condition is not met, the instruction in the delay slot is discarded.				
Branch On Less Than Or Equal To Zero Likely	BLEZL rs, offset If the contents of register rs are less than or equal to zero, the program branches to the target address. If the branch condition is not met, the instruction in the delay slot is discarded.				
Branch On Greater Than Zero	BGTZ rs, offset If the contents of register rs are greater than zero, the program branches to the target address. If the branch condition is not met, the instruction in the delay slot is discarded.				

Instruction	Format and Description				
		REGIMM	rs	sub	offset
Branch On Less Than Zero Likely	BLTZL rs, offset If the contents of register rs are less than zero, the program branches to the target address. If the branch condition is not met, the instruction in the delay slot is discarded.				
Branch On Greater Than Or Equal To Zero Likely	BGEZL rs, offset If the contents of register rs are greater than or equal to zero, the program branches to the target address. If the branch condition is not met, the instruction in the delay slot is discarded.				
Branch On Less Than Zero And Link Likely	BLTZALL rs, offset The address of the instruction that follows delay slot is stored to register r31 (link register). If the contents of register rs are less than zero, the program branches to the target address. If the branch condition is not met, the instruction in the delay slot is discarded.				
Branch On Greater Than Or Equal To Zero And Link Likely	BGEZALL rs, offset The address of the instruction that follows delay slot is stored to register r31 (link register). If the contents of register rs are greater than or equal to zero, the program branches to the target address. If the branch condition is not met, the instruction in the delay slot is discarded.				

Instruction	Format and Description				
		COP0	BC	br	offset
Branch On Coprocessor 0 True Likely	BCOTL offset Adds the 16-bit offset (shifted left by two bits and sign extended to 32 bits) to the address of the instruction in the delay slot to calculate out the branch target address. If the conditional signal of the coprocessor 0 is true, the program branches to the target address with one-instruction delay. If the branch condition is not met, the instruction in the delay slot is discarded.				
Branch On Coprocessor 0 False Likely	BCOFL offset Adds the 16-bit offset (shifted left by two bits and sign extended to 32 bits) to the address of the instruction in the delay slot to calculate out the branch target address. If the conditional signal of the coprocessor 0 is false, the program branches to the target address with one-instruction delay. If the branch condition is not met, the instruction in the delay slot is discarded.				

3.2.4 Special Instructions

Special instructions generate software exceptions. Their formats are R-type (Syscall, Break). The Trap instruction is available only for the VR4000 Series. All the other instructions are available for all VR Series.

Table 3-17. Special Instructions

Instruction	Format and Description	SPECIAL	rs	rt	rd	sa	funct
Synchronize	SYNC Completes the load/store instruction executing in the current pipeline before the next load/store instruction starts execution.						
System Call	SYSCALL Generates a system call exception, and then transits control to the exception handling program.						
Breakpoint	BREAK Generates a break point exception, and then transits control to the exception handling program.						

Table 3-18. Special Instructions (Extended ISA) (1/2)

Instruction	Format and Description	SPECIAL	rs	rt	rd	sa	funct
Trap If Greater Than Or Equal	TGE rs, rt The contents of register rs are compared with that of register rt, treating both operands as signed integers. If the contents of register rs are greater than or equal to that of register rt, an exception occurs.						
Trap If Greater Than Or Equal Unsigned	TGEU rs, rt The contents of register rs are compared with that of register rt, treating both operands as unsigned integers. If the contents of register rs are greater than or equal to that of register rt, an exception occurs.						
Trap If Less Than	TLT rs, rt The contents of register rs are compared with that of register rt, treating both operands as signed integers. If the contents of register rs are less than that of register rt, an exception occurs.						
Trap If Less Than Unsigned	TLTU rs, rt The contents of register rs are compared with that of register rt, treating both operands as unsigned integers. If the contents of register rs are less than that of register rt, an exception occurs.						
Trap If Equal	TEQ rs, rt If the contents of registers rs and rt are equal, an exception occurs.						
Trap If Not Equal	TNE rs, rt If the contents of registers rs and rt are not equal, an exception occurs.						

Table 3-18. Special Instruction (Extended ISA) (2/2)

Instruction	Format and Description	REGIMM	rs	sub	immediate
Trap If Greater Than Or Equal Immediate	TGEI rs, immediate The contents of register rs are compared with 16-bit sign-extended immediate data, treating both operands as signed integers. If the contents of register rs are greater than or equal to 16-bit sign-extended immediate data, an exception occurs.				
Trap If Greater Than Or Equal Immediate Unsigned	TGEIU rs, immediate The contents of register rs are compared with 16-bit zero-extended immediate data, treating both operands as unsigned integers. If the contents of register rs are greater than or equal to 16-bit sign-extended immediate data, an exception occurs.				
Trap If Less Than Immediate	TLTI rs, immediate The contents of register rs are compared with 16-bit sign-extended immediate data, treating both operands as signed integers. If the contents of register rs are less than 16-bit sign-extended immediate data, an exception occurs.				
Trap If Less Than Immediate Unsigned	TLTIU rs, immediate The contents of register rs are compared with 16-bit zero-extended immediate data, treating both operands as unsigned integers. If the contents of register rs are less than 16-bit sign-extended immediate data, an exception occurs.				
Trap If Equal Immediate	TEQI rs, immediate If the contents of register rs and immediate data are equal, an exception occurs.				
Trap If Not Equal Immediate	TNEI rs, immediate If the contents of register rs and immediate data are not equal, an exception occurs.				

3.2.5 System Control Coprocessor (CP0) Instructions

System control coprocessor (CP0) instructions perform operations specifically on the CP0 registers to manipulate the memory management and exception handling facilities of the processor.

Table 3-19. System Control Coprocessor (CP0) Instructions (1/2)

Instruction	Format and Description	COP0	sub	rt	rd	0
Move To System Control Coprocessor	MTC0 rt, rd The word data of general-purpose register rt in the CPU are loaded into general-purpose register rd in the CP0.					
Move From System Control Coprocessor	MFC0 rt, rd The word data of general-purpose register rd in the CP0 are loaded into general-purpose register rt in the CPU.					
Doubleword Move To System Control Coprocessor 0	DMTC0 rt, rd The doubleword data of general-purpose register rt in the CPU are loaded into general-purpose register rd in the CP0.					
Doubleword Move From System Control Coprocessor 0	DMFC0 rt, rd The doubleword data of general-purpose register rd in the CP0 are loaded into general-purpose register rt in the CPU.					

Table 3-19. System Control Coprocessor (CP0) Instructions (2/2)

Instruction	Format and Description	COP0		
		CO	funct	
Read Indexed TLB Entry	TLBR The TLB entry indexed by the index register is loaded into the entryHi, entryLo0, entryLo1, or page mask register.			
Write Indexed TLB Entry	TLBWI The contents of the entryHi, entryLo0, entryLo1, or page mask register are loaded into the TLB entry indexed by the index register.			
Write Random TLB Entry	TLBWR The contents of the entryHi, entryLo0, entryLo1, or page mask register are loaded into the TLB entry indexed by the random register.			
Probe TLB For Matching Entry	TLBP The address of the TLB entry that matches with the contents of entryHi register is loaded into the index register.			
Return From Exception	ERET The program returns from exception, interrupt, or error trap.			

Instruction	Format and Description	COP0		
		CO	funct	
STANDBY	STANDBY The processor's operating mode is transited from fullspeed mode to standby mode.			
SUSPEND	SUSPEND The processor's operating mode is transited from fullspeed mode to suspend mode.			
HIBERNATE	HIBERNATE The processor's operating mode is transited from fullspeed mode to hibernate mode.			

Instruction	Format and Description	CACHE	base	op	offset
		Cache Operation	Cache op, offset (base) The 16-bit offset is sign extended to 32 bits and added to the contents of the register case, to form virtual address. This virtual address is translated to physical address with TLB. For this physical address, cache operation that is indicated by 5-bit sub-opcode is performed.		

CHAPTER 4 VR4102 PIPELINE

This chapter describes the basic operation of the VR4102 processor pipeline, which includes descriptions of the delay slots (instructions that follow a branch or load instruction in the pipeline), interrupts to the pipeline flow caused by interlocks and exceptions, and CP0 hazards.

4.1 PIPELINE STAGES

The VR4102 has a five-stage instruction pipeline; each stage takes one PCycle (one cycle of Pclock), and each PCycle has two phases: $\Phi 1$ and $\Phi 2$, as shown in Figure 4-1. Thus, the execution of each instruction takes at least 5 PCycles. An instruction can take longer - for example, if the required data is not in the cache, the data must be retrieved from main memory. Once the pipeline has been filled, five instructions are executed simultaneously.

Figure 4-1. Pipeline Stages

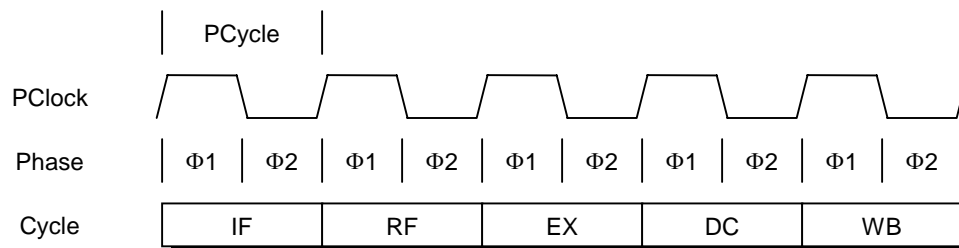

The five pipeline stages are:

- ◇ IF - Instruction cache fetch
- ◇ RF - Register fetch
- ◇ EX - Execution
- ◇ DC - Data cache fetch
- ◇ WB - Write back

Figure 4-2 shows the five stages of the instruction pipeline. In this figure, a row indicates the execution process of each instruction, and a column indicates the processes executed simultaneously.

Figure 4-2. Instruction Execution in the Pipeline

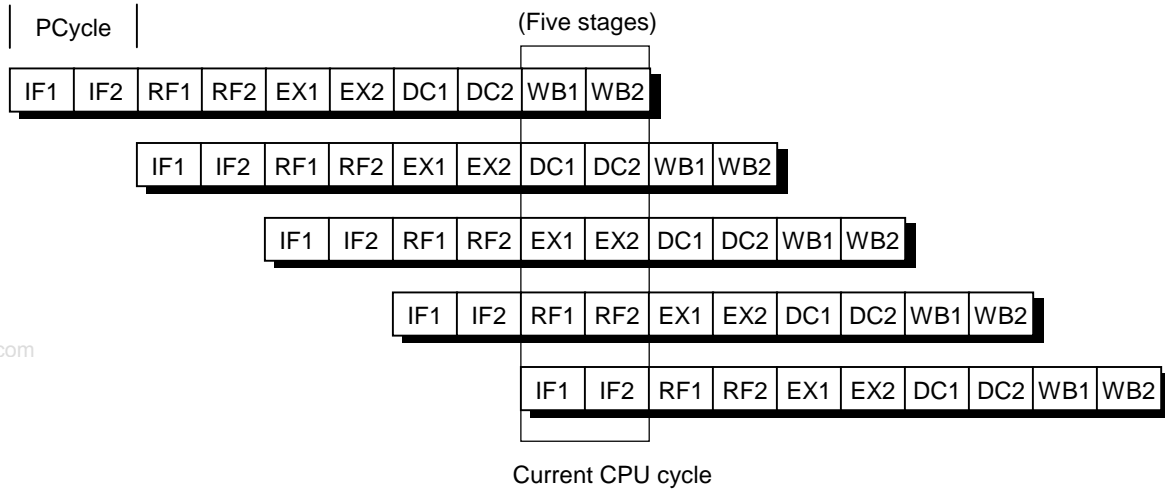

www.DataSheet4U.com

4.1.1 Pipeline Activities

Figure 4-3 shows the activities that can occur during each pipeline stage; Table 4-1 describes these pipeline activities.

Figure 4-3. Pipeline Activities

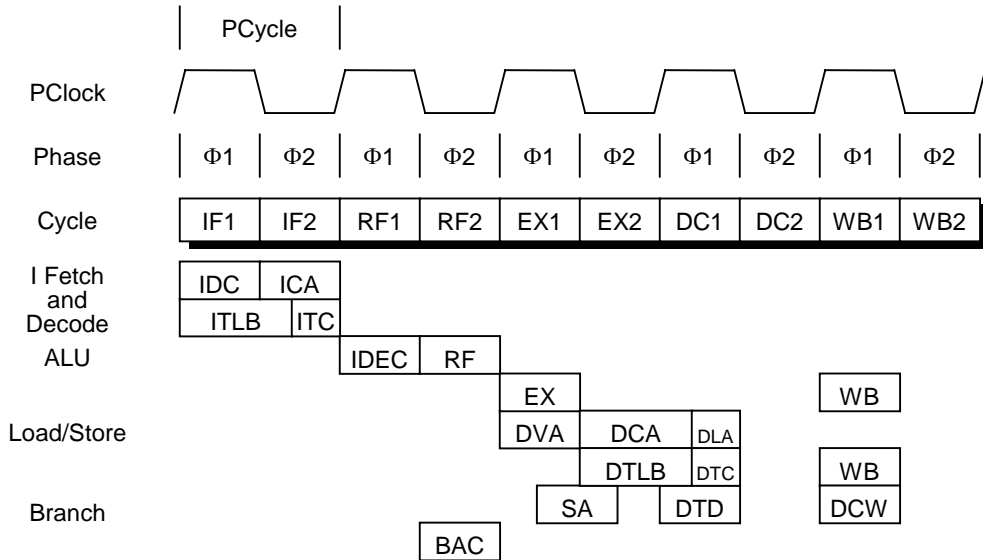

Table 4-1. Description of Pipeline Activities during Each Stage

Cycle	Phase	Mnemonic	Description
IF	Φ1	IDC	Instruction cache address decode
		ITLB	Instruction address translation
	Φ2	ICA	Instruction cache array access
		ITC	Instruction tag check
RF	Φ1	IDEC	Instruction decode
	Φ2	RF	Register operand fetch
		BAC	Branch address calculation
EX	Φ1	EX	Execution stage
		DVA	Data virtual address calculation
		SA	Store align
	Φ2	DCA	Data cache address decode/array access
		DTLB	Data address translation
DC	Φ1	DLA	Data cache load align
		DTC	Data tag check
		DTD	Data transfer to data cache
WB	Φ1	DCW	Data cache write
		WB	Write back to register file

4.2 BRANCH DELAY

During a VR4102's pipeline operation, a one-cycle branch delay occurs when:

- Target address is calculated by a Jump instruction
- Branch condition of branch instruction is met and then logical operation starts for branch-destination comparison

The instruction address generated at the EX stage in the Jump/Branch instruction are available in the IF stage, two instructions later.

Figure 4-4 illustrates the branch delay and the location of the branch delay slot.

www.DataSheet4U.com

Figure 4-4. Branch Delay

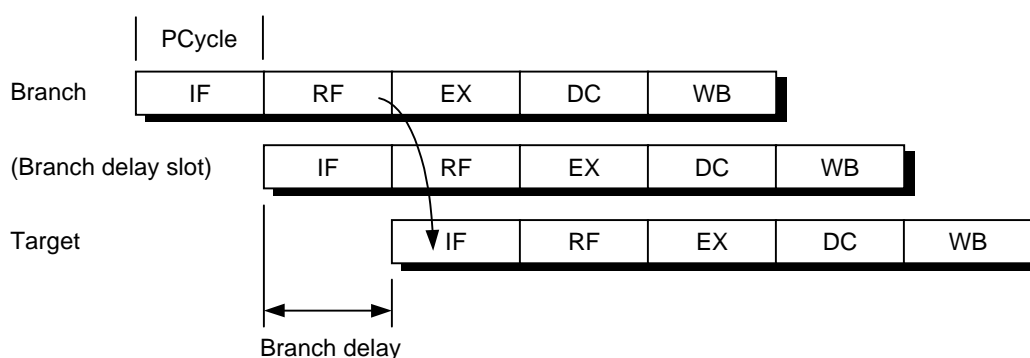

4.3 LOAD DELAY

A load instruction that does not allow its result to be used by the instruction immediately following is called a delayed load instruction. The instruction immediately following this delayed load instruction is referred to as the load delay slot.

In the VR4102, the instruction immediately following a load instruction can use the contents of the loaded register, however in such cases hardware interlocks insert additional delay cycles. Consequently, scheduling load delay slots can be desirable, both for performance and VR-Series processor compatibility.

4.4 PIPELINE OPERATION

The operation of the pipeline is illustrated by the following examples that describe how typical instructions are executed. The instructions described are: ADD, JALR, BEQ, TLT, LW, and SW. Each instruction is taken through the pipeline and the operations that occur in each relevant stage are described.

(1) Add instruction (Add rd, rs, rt)

- IF stage** In $\Phi 1$ of the IF stage, the eleven least-significant bits of the virtual address are used to access the instruction cache. In $\Phi 2$ of the IF stage, the cache index is compared with the page frame number and the cache data is read out. The virtual PC is incremented by 4 so that the next instruction can be fetched.
- RF stage** During $\Phi 2$, the 2-port register file is addressed with the rs and rt fields and the register data is valid at the register file output. At the same time, bypass multiplexers select inputs from either the EX- or DC-stage output in addition to the register file output, depending on the need for an operand bypass.
- EX stage** The ALU controls are set to do an A + B operation. The operands flow into the ALU inputs, and the ALU operation is started. The result of the ALU operation is latched into the ALU output latch during $\Phi 1$.
- DC stage** This stage is a NOP for this instruction. The data from the output of the EX stage (the ALU) is moved into the output latch of the DC.
- WB stage** During $\Phi 1$, the WB latch feeds the data to the inputs of the register file, which is accessed by the rd field. The file write strobe is enabled. By the end of $\Phi 1$, the data is written into the file.

Figure 4-5. Add Instruction Pipeline Activities

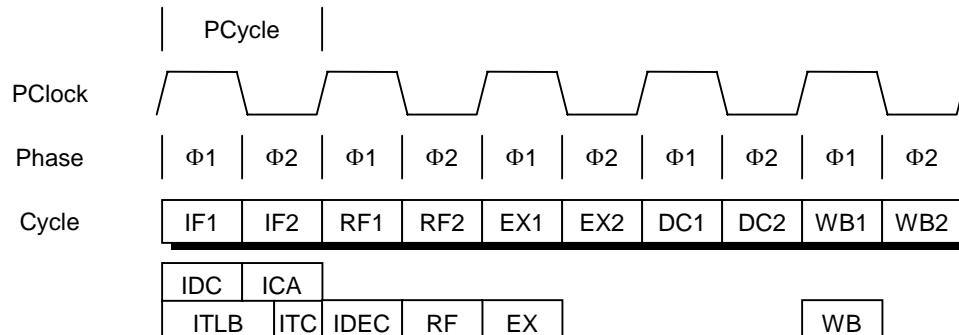

(3) Branch on Equal instruction (BEQ rs, rt, offset)

- IF stage Same as the IF stage for the ADD instruction.
- RF stage During $\Phi 2$, the register file is addressed with the rs and rt fields. A check is performed to determine if each corresponding bit position of these two operands has equal values. If they are equal, the PC is set to PC + target, where target is the sign-extended offset field. If they are not equal, the PC is set to PC + 4.
- EX stage The next PC resulting from the branch comparison is valid at the beginning of $\Phi 2$ for instruction fetch.
- DC stage This stage is a NOP for this instruction.
- WB stage This stage is a NOP for this instruction.

Figure 4-7. BEQ Instruction Pipeline Activities

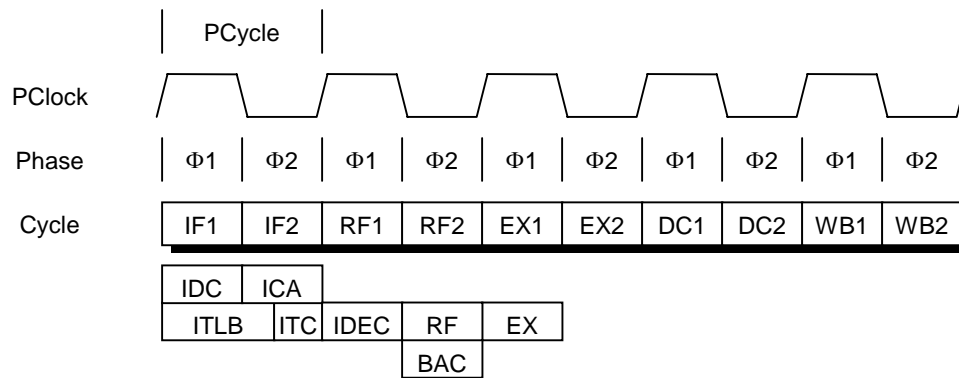

(4) Trap if Less Than instruction (TLT rs, rt)

- IF stage Same as the IF stage for the ADD instruction.
- RF stage Same as the RF stage for the ADD instruction.
- EX stage ALU controls are set to do an A – B operation. The operands flow into the ALU inputs, and the ALU operation is started. The result of the ALU operation is latched into the ALU output latch during $\Phi 1$. The sign bits of operands and of the ALU output latch are checked to determine if a less than condition is true. If this condition is true, a Trap exception occurs. The value in the PC register is used as an exception vector value, and from now on any instruction will be invalid.
- DC stage No operation
- WB stage The EPC register is loaded with the value of the PC if the less than condition was met in the EX stage. The Cause register ExCode field and BD bit are updated appropriately, as is the EXL bit of the Status register. If the less than condition was not met in the EX stage, no activity occurs in the WB stage.

Figure 4-8. TLT Instruction Pipeline Activities

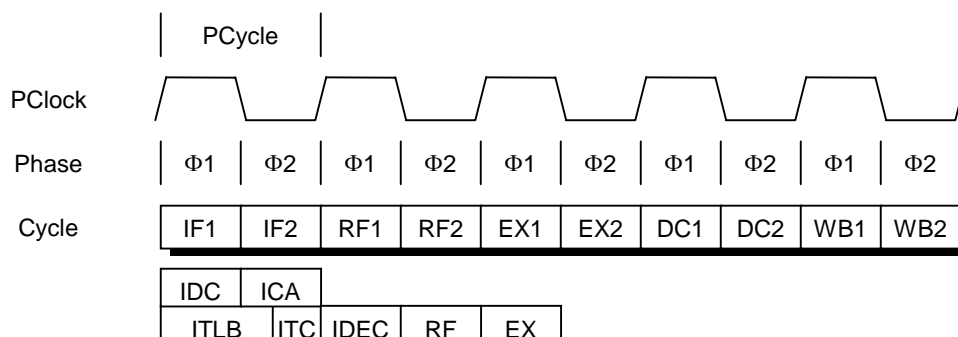

(5) Load Word instruction (LW rt, offset (base))

- IF stage Same as the IF stage for the ADD instruction.
- RF stage Same as the RF stage for the ADD instruction. Note that the base field is in the same position as the rs field.
- EX stage Refer to the EX stage for the ADD instruction. For LW, the inputs to the ALU come from GPR[base] through the bypass multiplexer and from the sign-extended offset field. The result of the ALU operation that is latched into the ALU output latch in $\Phi 1$ represents the effective virtual address of the operand (DVA).
- DC stage The cache tag field is compared with the Page Frame Number (PFN) field of the TLB entry. After passing through the load aligner, aligned data is placed in the DC output latch during $\Phi 2$.
- WB stage During $\Phi 1$, the cache read data is written into the register file addressed by the rt field.

Figure 4-9. LW Instruction Pipeline Activities

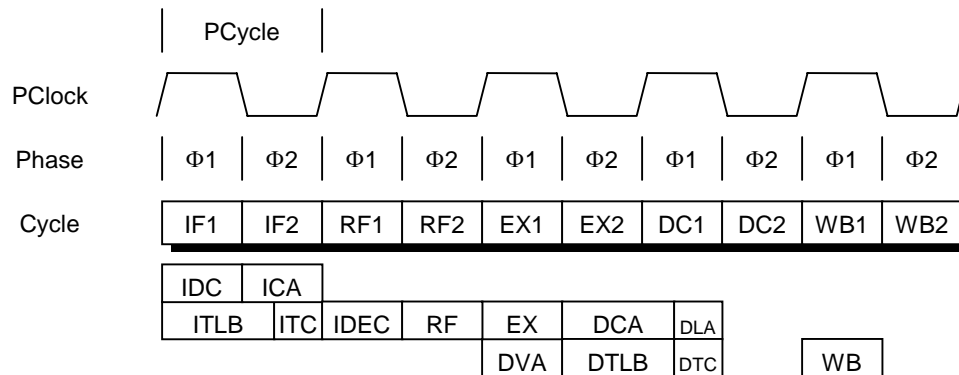

(6) Store Word instruction (SW rt, offset (base))

- IF stage Same as the IF stage for the ADD instruction.
- RF stage Same as the RF stage for the LW instruction.
- EX stage Refer to the LW instruction for a calculation of the effective address. From the RF output latch, the GPR[rt] is sent through the bypass multiplexer and into the main shifter, where the shifter performs the byte-alignment operation for the operand. The results of the ALU are latched in the output latches during $\Phi 1$. The shift operations are latched in the output latches during $\Phi 2$.
- DC stage Refer to the LW instruction for a description of the cache access.
- WB stage If there was a cache hit, the content of the store data output latch is written into the data cache at the appropriate word location.
 Note that all store instructions use the data cache for two consecutive PCycles. If the following instruction requires use of the data cache, the pipeline is slipped for one PCycle to complete the writing of an aligned store data.

Figure 4-10. SW Instruction Pipeline Activities

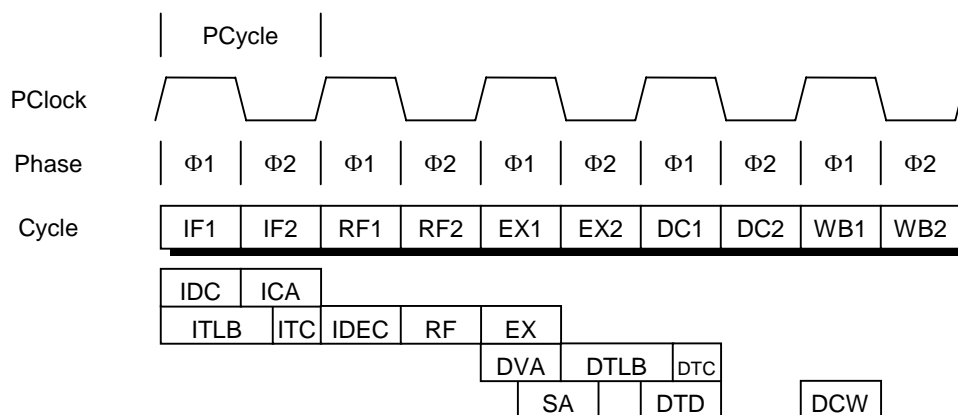

4.5 INTERLOCK AND EXCEPTION HANDLING

Smooth pipeline flow is interrupted when cache misses or exceptions occur, or when data dependencies are detected. Interruptions handled using hardware, such as cache misses, are referred to as interlocks, while those that are handled using software are called exceptions. As shown in Figure 4-11, all interlock and exception conditions are collectively referred to as faults.

Figure 4-11. Interlocks, Exceptions, and Faults

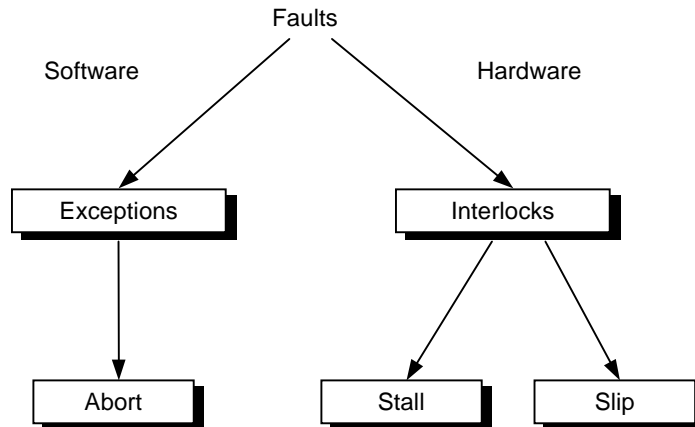

At each cycle, exception and interlock conditions are checked for all active instructions.

Because each exception or interlock condition corresponds to a particular pipeline stage, a condition can be traced back to the particular instruction in the exception/interlock stage, as shown in Table 4-2. For instance, an LDI Interlock is raised in the Register Fetch (RF) stage.

Tables 4-2 to 4-4 describe the pipeline interlocks and exceptions listed in Table 4-2.

Table 4-2. Correspondence of Pipeline Stage to Interlock and Exception Condition

Status \ Stage		IF	RF	EX	DC	WB
Interlock	Stall	–	ITM ICM	–	DTM DCM DCB	–
	Slip	–	LDI MDI SLI CP0	–	–	–
Exception		IAErr	NMI ITLB IPErr INTr IBE SYSC BP Cun RSVD	Trap OVF DAErr	Reset DTLB TMod DPErr WAT DBE	–

Remark In the above table, exception conditions are listed up in higher priority order.

Table 4-3. Description of Pipeline Exception

Exception	Description
IAErr	Instruction Address Error exception
NMI	Non-maskable Interrupt exception
ITLB	ITLB exception
IPErr	Instruction Parity Error exception
INTR	Interrupt exception
IBE	Instruction Bus Error exception
SYSC	System Call exception
BP	Breakpoint exception
CUn	Coprocessor Unusable exception
RSVD	Reserved Instruction exception
Trap	Trap exception
OVF	Overflow exception
DAErr	Data Address Error exception
Reset	Reset exception
DTLB	DTLB exception
DTMod	DTLB Modified exception
DPErr	Data Parity Error exception
WAT	Watch exception
DBE	Data Bus Error exception

Table 4-4. Pipeline Interlock

Interlock	Description
ITM	Interrupt TLB Miss
ICM	Interrupt Cache Miss
LDI	Load Data Interlock
MDI	MD Busy Interlock
SLI	Store-Load Interlock
CP0	Coprocessor 0 Interlock
DTM	Data TLB Miss
DCM	Data Cache Miss
DCB	Data Cache Busy

4.5.1 Exception Conditions

When an exception condition occurs, the relevant instruction and all those that follow it in the pipeline are cancelled. Accordingly, any stall conditions and any later exception conditions that may have referenced this instruction are inhibited; there is no benefit in servicing stalls for a cancelled instruction.

When an exceptional conditions is detected for an instruction, the Vr4102 will kill it and all following instructions. When this instruction reaches the WB stage, the exception flag and various information items are written to CP0 registers. The current PC is changed to the appropriate exception vector address and the exception bits of earlier pipeline stages are cleared.

This implementation allows all preceding instructions to complete execution and prevents all subsequent instructions from completing. Thus the value in the EPC is sufficient to restart execution. It also ensures that exceptions are taken in the order of execution; an instruction taking an exception may itself be killed by an instruction further down the pipeline that takes an exception in a later cycle.

Figure 4-12. Exception Detection

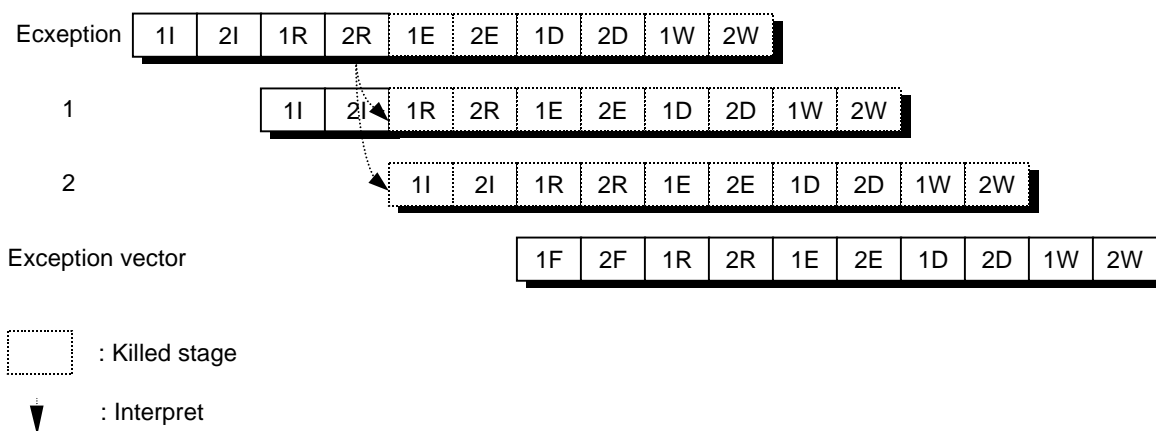

4.5.2 Stall Conditions

Stalls are used to stop the pipeline for conditions detected after the RF stage. When a stall occurs, the processor will resolve the condition and then the pipeline will continue. Figure 4-13 shows a data cache miss stall, and Figure 4-14 shows a CACHE instruction stall.

Figure 4-13. Data Cache Miss Stall

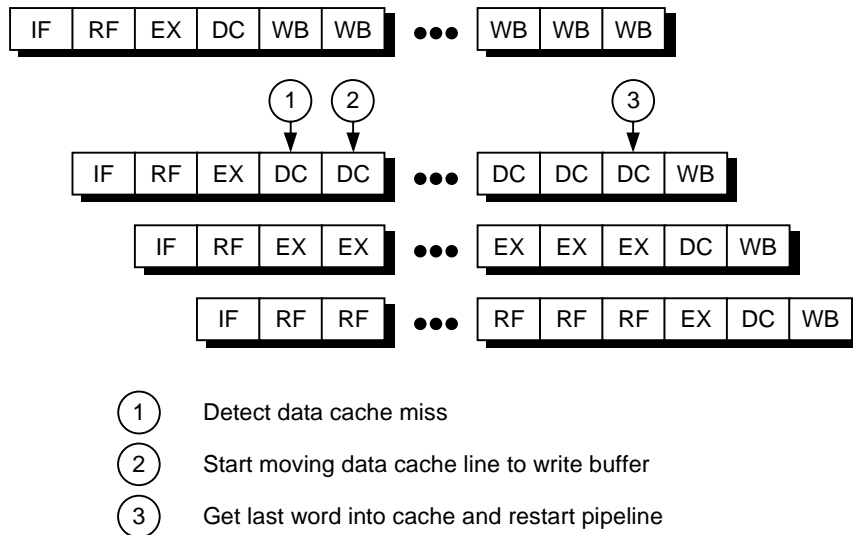

If the cache line to be replaced is dirty — the W bit is set — the data is moved to the internal write buffer in the next cycle. The write-back data is returned to memory. The last word in the data is returned to the cache at 3, and pipelining restarts.

Figure 4-14. CACHE Instruction Stall

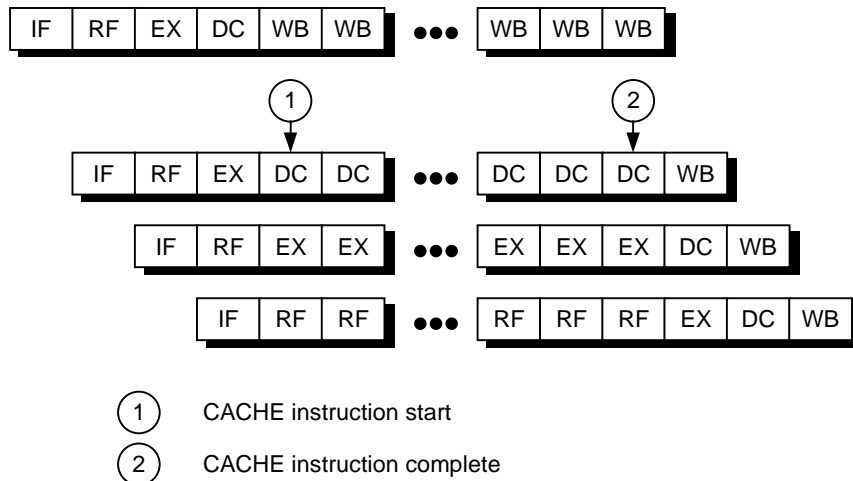

When the CACHE instruction enters the DC pipe-stage, the pipeline stalls while the CACHE instruction is executed. The pipeline begins running again when the CACHE instruction is completed, allowing the instruction fetch to proceed.

4.5.3 Slip Conditions

During $\Phi 2$ of the RF stage and $\Phi 1$ of the EX stage, internal logic will determine whether it is possible to start the current instruction in this cycle. If all of the source operands are available (either from the register file or via the internal bypass logic) and all the hardware resources necessary to complete the instruction will be available whenever required, then the instruction “run”; otherwise, the instruction will “slip”. Slipped instructions are retired on subsequent cycles until they issue. The backend of the pipeline (stages DC and WB) will advance normally during slips in an attempt to resolve the conflict. NOPs will be inserted into the bubble in the pipeline. Instructions killed by branch likely instructions, ERET or exceptions will not cause slips.

Figure 4-15. Load Data Interlock

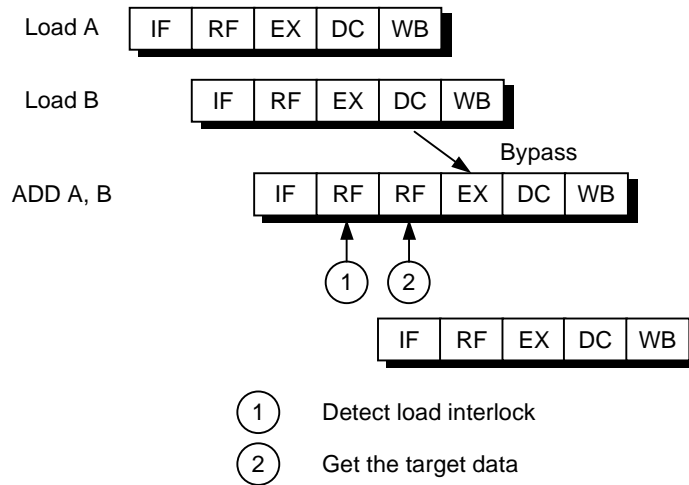

Load Data Interlock is detected in the RF stage shown in as Figure 4-15 and also the pipeline slips in the stage. Load Data Interlock occurs when data fetched by a load instruction and data moved from HI, LO or CP0 register is required by the next immediate instruction. The pipeline begins running again when the clock after the target of the load is read from the data cache, HI, LO and CP0 register. The data returned at the end of the DC stage is input into the end of the RF stage, using the bypass multiplexers.

Figure 4-16. MD Busy Interlock

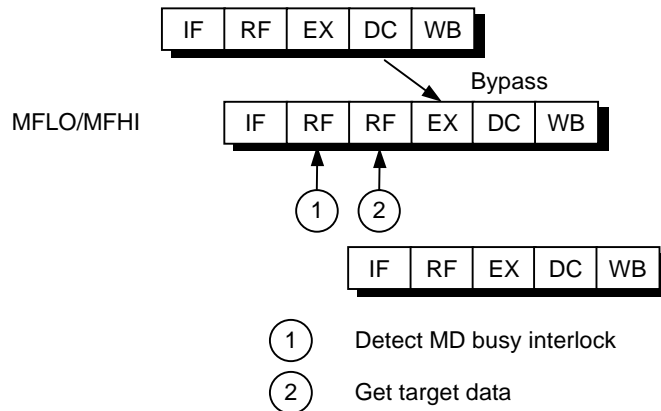

MD Busy Interlock is detected in the RF stage as shown in Figure 4-16 and also the pipeline slips in the stage. MD Busy Interlock occurs when Hi/Lo register is required by MFHi/Lo instruction before finishing Mult/Div execution. The pipeline begins running again the clock after finishing Mult/Div execution. The data returned from the Hi/Lo register at the end of the DC stage is input into the end of the RF stage, using the bypass multiplexers.

Store-Load Interlock is detected in the EX stage and the pipeline slips in the RF stage. Store-Load Interlock occurs when store instruction followed by load instruction is detected. The pipeline begins running again one clock after.

Coprocessor 0 Interlock is detected in the EX stage and the pipeline slips in the RF stage. A coprocessor interlock occurs when an MTC0 instruction for the Configuration or Status register is detected.

www.DataSheet4U.com The pipeline begins running again one clock after.

4.5.4 Bypassing

In some cases, data and conditions produced in the EX, DC and WB stages of the pipeline are made available to the EX stage (only) through the bypass data path.

Operand bypass allows an instruction in the EX stage to continue without having to wait for data or conditions to be written to the register file at the end of the WB stage. Instead, the Bypass Control Unit is responsible for ensuring data and conditions from later pipeline stages are available at the appropriate time for instructions earlier in the pipeline.

The Bypass Control Unit is also responsible for controlling the source and destination register addresses supplied to the register file.

4.6 CODE COMPATIBILITY

The VR4100 CPU core can execute all programs that can be executed in other VR-Series processors. But the reverse is not necessarily true. Programs compiled using a standard MIPS compiler can be executed in both types of processors. When using manual assembly, however, write programs carefully so that compatibility with other VR-series processors can be maintained. Matters which should be paid attention to when porting programs between the VR4100 CPU core and other VR-Series processors are listed below.

- The VR4100 CPU core does not support floating-point instructions since it has no Floating-Point Unit (FPU).
- Multiply-add instructions (DMADD16, MADD16) are added in the VR4100 CPU core.
- Instructions for power modes (HIBERNATE, STANDBY, SUSPEND) are added in the VR4100 CPU core to support power modes.
- The VR4100 CPU core does not have the LL bit to perform synchronization of multiprocessing. Therefore, the CPU core does not support instructions which manipulate the LL bit (LL, LLD, SC, SCD).
- The CP0 hazards of the VR4100 CPU core are equally or less stringent than those of other processors (see Chapter 28 for details).

For more information, refer to Chapter 27, *the VR4000, VR4400 User's Manual*, or *the VR4200™ User's Manual*.

[MEMO]

www.DataSheet4U.com

CHAPTER 5 MEMORY MANAGEMENT SYSTEM

The VR4102 provides a memory management unit (MMU) which uses a translation lookaside buffer (TLB) to translate virtual addresses into physical addresses. This chapter describes the virtual and physical address spaces, the virtual-to-physical address translation, the operation of the TLB in making these translations, and the CP0 registers that provide the software interface to the TLB.

5.1 TRANSLATION LOOKASIDE BUFFER (TLB)

Virtual addresses are translated into physical addresses using an on-chip TLB 22. The on-chip TLB is a fully-associative memory that holds 32 entries, which provide mapping to 32 odd/even page pairs for one entry. The pages can have five different sizes, 1 K, 4 K, 16 K, 64 K, and 256 K, and can be specified in each entry. If it is supplied with a virtual address, each of the 32 TLB entries is checked simultaneously to see whether they match the virtual addresses that are provided with the ASID field and saved in the EntryHi register.

If there is a virtual address match, or “hit,” in the TLB, the physical page number is extracted from the TLB and concatenated with the offset to form the physical address.

If no match occurs (TLB “miss”), an exception is taken and software refills the TLB from the page table resident in memory. The software writes to an entry selected using the Index register or a random entry indicated in the Random register.

If more than one entry in the TLB matches the virtual address being translated, the operation is undefined and the TLB may be disabled. In this case, the TLB-Shutdown (TS) bit of the Status register is set to 1, and the TLB becomes unusable (an attempt to access the TLB results in a TLB Mismatch exception regardless of whether there is an entry that hits). The TS bit can be cleared only by a reset.

Note that virtual addresses may be converted to physical addresses without using a TLB, depending on the address space that is being subjected to address translation. For example, address translation for the kseg0 or kseg1 address space does not use mapping. The physical addresses of these address spaces are determined by subtracting the base address of the address space from the virtual addresses.

5.2 VIRTUAL ADDRESS SPACE

The address space of the CPU is extended in memory management system, by converting (translating) huge virtual memory addresses into physical addresses.

The physical address space of the VR4102 is 4 Gbytes and 32-bit width addresses are used.

For the virtual address space, up to 2 Gbytes (2^{31}) are provided as a user's area and 32-bit width addresses are used in the 32-bit mode. In the 64-bit mode, up to 1 Tbyte (2^{40}) is provided as a user's area and 64-bit width addresses are used. For the format of the TLB entry in each mode, refer to 5.4.1.

As shown in Figures 4-2 and 4-3, the virtual address is extended with an address space identifier (ASID), which reduces the frequency of TLB flushing when switching contexts. This 8-bit ASID is in the CP0 EntryHi register, and the Global (G) bit is in the EntryLo0 and EntryLo1 registers, described later in this chapter.

Figure 5-1. Virtual-to-Physical Address Translation

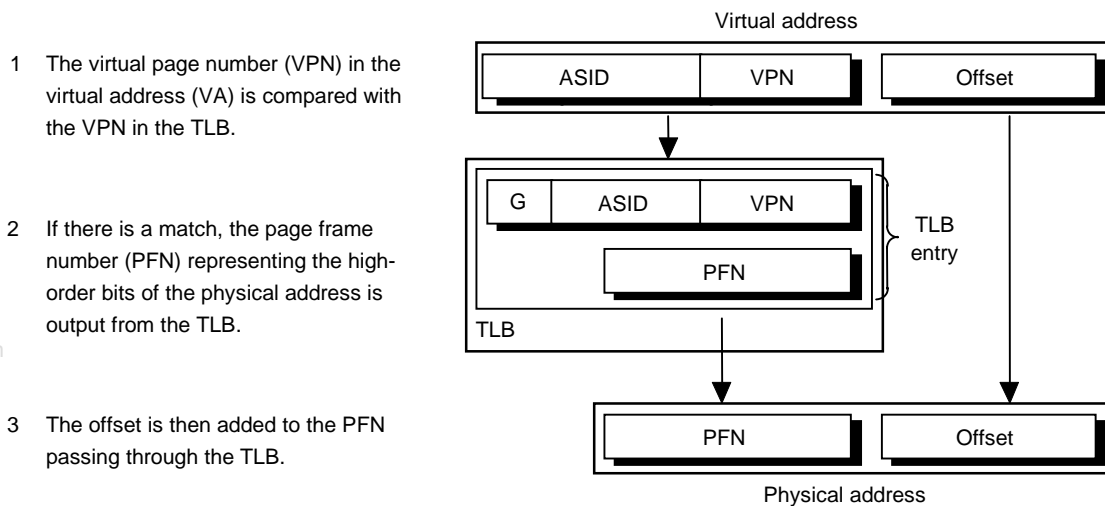

5.2.1 Virtual-to-Physical Address Translation

Converting a virtual address to a physical address begins by comparing the virtual address from the processor with the virtual addresses in the TLB; there is a match when the virtual page number (VPN) of the address is the same as the VPN field of the entry, and either:

- ✧ the Global (G) bit of the TLB entry is set to 1, or
- ✧ the ASID field of the virtual address is the same as the ASID field of the TLB entry.

This match is referred to as a TLB hit. If there is no match, a TLB Mismatch exception is taken by the processor and software is allowed to refill the TLB from a page table of virtual/physical addresses in memory.

If there is a virtual address match in the TLB, the physical address is output from the TLB and concatenated with the offset, which represents an address within the page frame space. The offset does not pass through the TLB. Instead, the low-order bits of the virtual address are output without being translated. See descriptions about the virtual address space for details. For details about the physical address, see **5.4.9 Virtual-to-Physical Address Translation**.

The next two sections describe the 32-bit and 64-bit mode address translations.

5.2.2 32-bit Mode Address Translation

Figure 5-2 shows the virtual-to-physical-address translation of a 32-bit mode address. The pages can have five different sizes between 1 Kbyte (10 bits) and 256 Kbytes (18 bits), each being 4 times as large as the preceding one in ascending order, that is 1 K, 4 K, 16 K, 64 K, and 256 K.

- ✧ Shown at the top of Figure 5-2 is the virtual address space in which the page size is 1 Kbyte and the offset is 10 bits. The 22 bits excluding the ASID field represents the virtual page number (VPN), enabling selecting a page table of 4 M entries.
- ✧ Shown at the bottom of Figure 5-2 is the virtual address space in which the page size is 256 Kbytes and the offset is 18 bits. The 14 bits excluding the ASID field represents the VPN, enabling selecting a page table of 16 K entries.

www.DataSheet4U.com

Figure 5-2. 32-bit Mode Virtual Address Translation

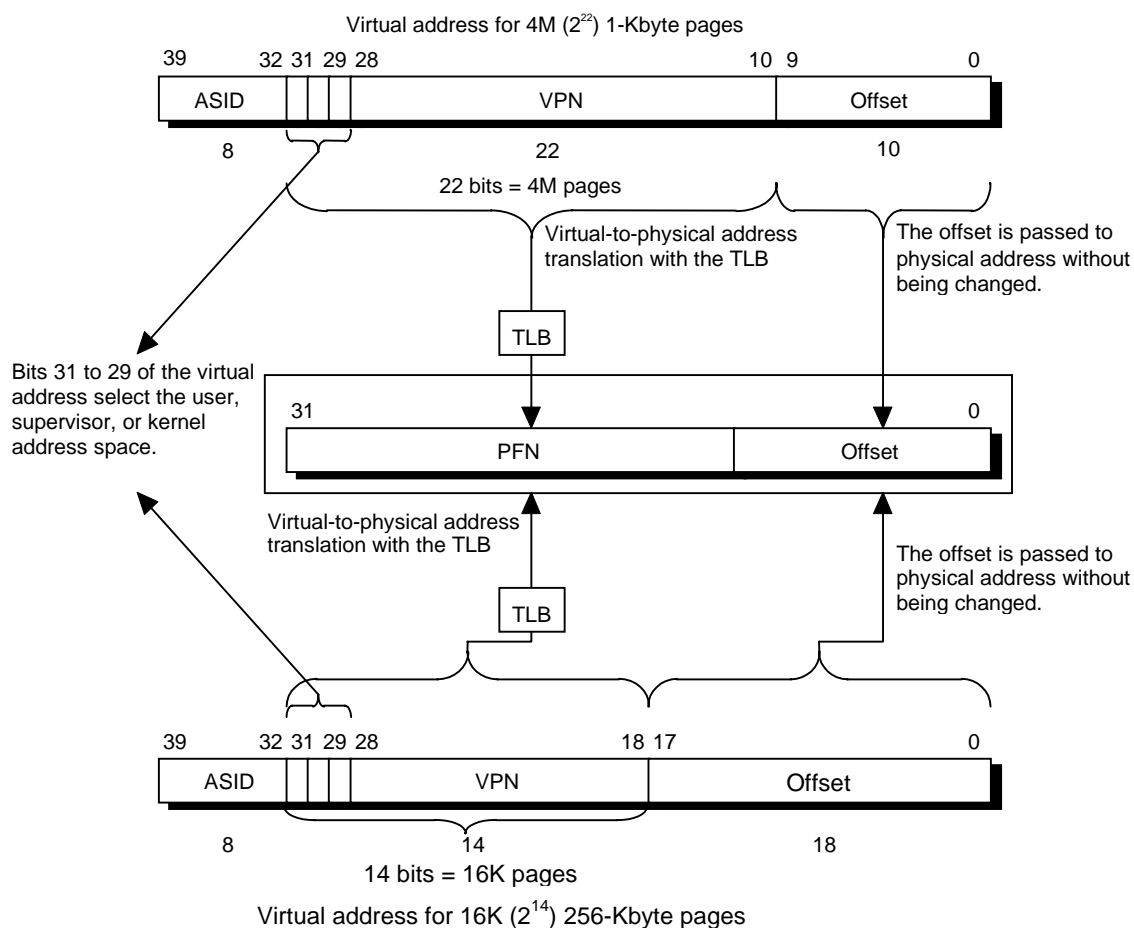

5.2.3 64-bit Mode Address Translation

Figure 5-3 shows the virtual-to-physical-address translation of a 64-bit mode address. The pages can have five different sizes between 1 Kbyte (10 bits) and 256 Kbytes (18 bits), each being 4 times as large as the preceding one in ascending order, that is 1K, 4K, 16K, 64K, and 256K. This figure illustrates the two possible page sizes: a 1-Kbyte page (10 bits) and a 256-Kbyte page (18 bits).

✧ Shown at the top of Figure 5-3 is the virtual address space in which the page size is 1 Kbyte and the offset is 10 bits. The 30 bits excluding the ASID field represents the virtual page number (VPN), enabling selecting a page table of 1 G entry.

✧ Shown at the bottom of Figure 5-3 is the virtual address space in which the page size is 256 Kbytes and the offset is 18 bits. The 22 bits excluding the ASID field represents the VPN, enabling selecting a page table of 4 M entries.

Figure 5-3. 64-bit Mode Virtual Address Translation

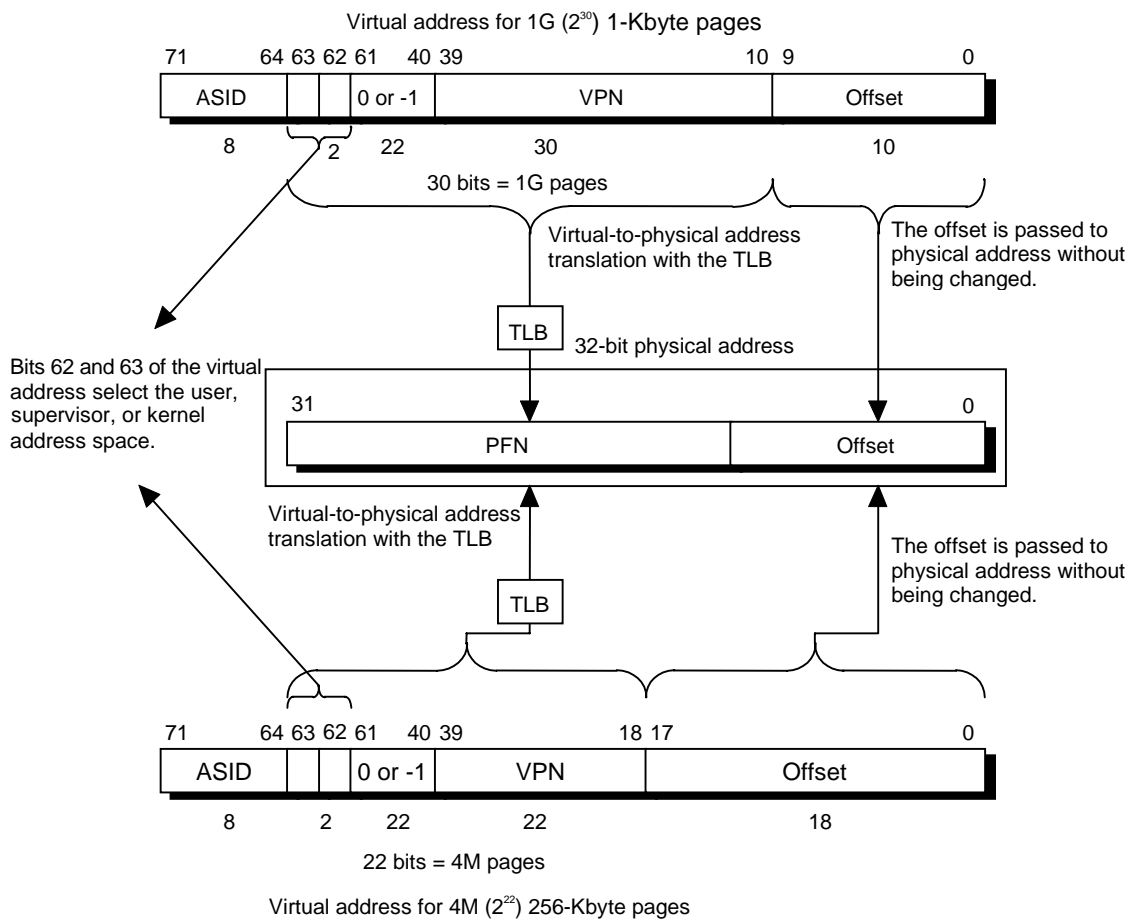

5.2.4 Operating Modes

The processor has three operating modes that function in both 32- and 64-bit operations:

- ✧ User mode
- ✧ Supervisor mode
- ✧ Kernel mode

User and Kernel modes are common to all V_R-Series processors. Generally, Kernel mode is used to executing the operating system, while User mode is used to run application programs. The V_R4000 series processors have a third mode, which is called Supervisor mode and categorized in between User and Kernel modes. This mode is used to configure a high-security system.

When an exception occurs, the CPU enters Kernel mode, and remains in this mode until an exception return instruction (ERET) is executed. The ERET instruction brings back the processor to the mode in which it was just before the exception occurs.

These modes are described in the next three sections.

5.2.5 User Mode Virtual Addressing

During the single user mode, a 2-Gbyte (2^{31} bytes) virtual address space (useg) can be used in the 32-bit mode. In the 64-bit mode, a 1-Tbyte (2^{40} bytes) virtual address space (xuseg) can be used.

As shown in Tables 5-2 and 5-3, each virtual address is extended independently as another virtual address by setting an 8-bit address space ID area (ASID), to support user processes of up to 256. The contents of TLB can be retained after context switching by allocating each process by ASID. useg and xuseg can be referenced via TLB. Whether a cache is used or not is determined for each page by the TLB entry (depending on the C bit setting in the TLB entry).

The User segment starts at address 0 and the current active user process resides in either useg (in 32-bit mode) or xuseg (in 64-bit mode). The TLB identically maps all references to useg/xuseg from all modes, and controls cache accessibility.

The processor operates in User mode when the Status register contains the following bit-values:

- ✧ KSU = 10
- ✧ EXL = 0
- ✧ ERL = 0

In conjunction with these bits, the UX bit in the Status register selects 32- or 64-bit User mode addressing as follows:

- ✧ When UX = 0, 32-bit useg space is selected.
- ✧ When UX = 1, 64-bit xuseg space is selected.

Table 5-1 lists the characteristics of each user segment (useg and xuseg).

Figure 5-4. User Mode Address Space

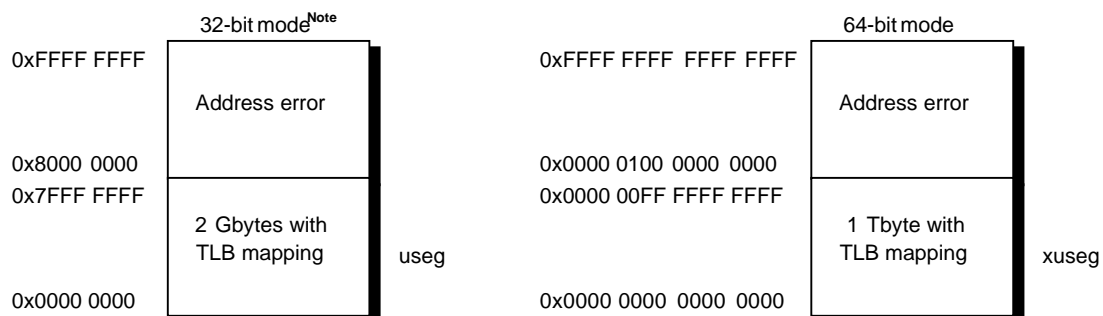

www.DataSheet4U.com

Note The VR4102 uses 64-bit addresses within it. When the processor is running in Kernel mode, it saves the contents of each register or restores their previous contents to initialize them before switching the context. For 32-bit mode addressing, bit 31 is sign-extended to bits 32 to 63, and the resulting 32 bits are used for addressing. Usually, it is impossible for 32-bit mode programs to generate invalid addresses. If context switching occurs and the processor enters Kernel mode, however, an attempt may be made to save an address other than the sign-extended 32-bit address mentioned above to a 64-bit register. In this case, user-mode programs are likely to generate an invalid address.

Table 5-1. Comparison of useg and xuseg

Address bit value	Status register bit value				Segment name	Address range	Size
	KSU	EXL	ERL	UX			
32-bit A[31] = 0	10	0	0	0	useg	0x0000 0000 to 0x7FFF FFFF	2 Gbytes (2 ³¹ bytes)
64-bit A[63..40] = 0	10	0	0	1	xuseg	0x0000 0000 0000 0000 to 0x0000 00FF FFFF FFFF	1 Tbyte (2 ⁴⁰ bytes)

(1) useg (32-bit mode)

In User mode, when UX = 0 in the Status register and the most significant bit of the virtual address is 0, User mode addressing is compatible with the 32-bit addressing model shown in Figure 5-4, and a 2-Gbyte user address space is available, labeled useg.

Any attempt to reference an address with the most-significant bit set while in User mode causes an Address Error exception (see **CHAPTER 6 EXCEPTION PROCESSING**).

The TLB Mismatch exception vector is used for TLB misses.

(2) xuseg (64-bit mode)

In User mode, when UX = 1 in the Status register and bits 63 to 40 of the virtual address are all 0, User mode addressing is extended to the 64-bit addressing model shown in Figure 5-4. In 64-bit User mode, the processor provides a single address space of 240 bytes, labeled xuseg.

Any attempt to reference an address with bits 63:40 equal to 1 causes an Address Error exception (see **CHAPTER 6 EXCEPTION PROCESSING**).

The XTLB Mismatch exception vector is used for TLB misses.

5.2.6 Supervisor-mode Virtual Addressing

Supervisor mode is designed for layered operating systems in which a true kernel runs in Kernel mode, and the rest of the operating system runs in Supervisor mode.

All of the suseg, sseg, xsuseg, xsseg, and csseg spaces are referenced via TLB. Whether cache can be used or not is determined by bit C of each page's TLB entry.

The processor operates in Supervisor mode when the Status register contains the following bit-values:

- ✧ KSU = 01
- ✧ EXL = 0
- ✧ ERL = 0

www.DataSheet4U.com In conjunction with these bits, the SX bit in the Status register selects 32- or 64-bit Supervisor mode addressing:

- ✧ When SX = 0, 32-bit supervisor space is selected.
- ✧ When SX = 1, 64-bit supervisor space is selected.

Table 5-2 lists the characteristics of the Supervisor mode segments.

Figure 5-5. Supervisor Mode Address Space

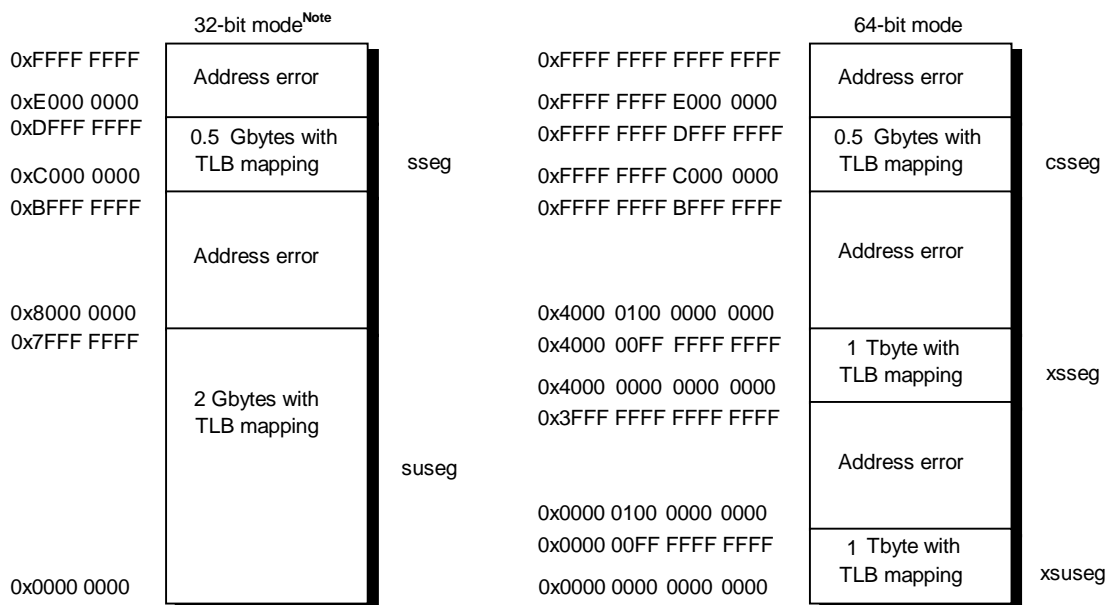

Note The VR4102 uses 64-bit addresses within it. For 32-bit mode addressing, bit 31 is sign-extended to bits 32 to 63, and the resulting 32 bits are used for addressing. Usually, it is impossible for 32-bit mode programs to generate invalid addresses. In an operation of base register + offset for addressing, however, a two's complement overflow may occur, causing an invalid address. Note that the result becomes undefined. Two factors that can cause a two's complement follow:

- ◇ When offset bit 15 is 0, base register bit 31 is 0, and bit 31 of the operation “base register + offset” is 1
- ◇ When offset bit 15 is 1, base register bit 31 is 1, and bit 31 of the operation “base register + offset” is 0

Table 5-2. 32-bit and 64-bit Supervisor Mode Segments

Address bit value	Status register bit value				Segment name	Address range	Size
	KSU	EXL	ERL	SX			
32-bit A[31] = 0	01	0	0	0	suseg	0x0000 0000 to 0x7FFF FFFF	2 Gbytes (2^{31} bytes)
32-bit A[31..29] = 110	01	0	0	0	sseg	0xC000 0000 to 0xDFFF FFFF	512 Mbytes (2^{29} bytes)
64-bit A[63..62] = 00	01	0	0	1	xsuseg	0x0000 0000 0000 0000 to 0x0000 00FF FFFF FFFF	1 Tbyte (2^{40} bytes)
64-bit A[63..62] = 01	01	0	0	1	xsseg	0x4000 0000 0000 0000 to 0x4000 00FF FFFF FFFF	1 Tbyte (2^{40} bytes)
64-bit A[63..62] = 11	01	0	0	1	csseg	0xFFFF FFFF C000 0000 to 0xFFFF FFFF DFFF FFFF	512 Mbytes (2^{29} bytes)

(1) suseg (32-bit Supervisor mode, user space)

When SX = 0 in the Status register and the most-significant bit of the virtual address space is set to 0, the suseg virtual address space is selected; it covers 2 Gbytes (2^{31} bytes) of the current user address space. The virtual address is extended with the contents of the 8-bit ASID field to form a unique virtual address. This mapped space starts at virtual address 0x0000 0000 and runs through 0x7FFF FFFF.

(2) sseg (32-bit Supervisor mode, supervisor space)

When SX = 0 in the Status register and the three most-significant bits of the virtual address space are 110, the sseg virtual address space is selected; it covers 512 Mbytes (2^{29} bytes) of the current supervisor virtual address space. The virtual address is extended with the contents of the 8-bit ASID field to form a unique virtual address. This mapped space begins at virtual address 0xC000 0000 and runs through 0xDFFF FFFF.

(3) xsuseg (64-bit Supervisor mode, user space)

When SX = 1 in the Status register and bits 63 and 62 of the virtual address space are set to 00, the xsuseg virtual address space is selected; it covers 1 Tbyte (2^{40} bytes) of the current user address space. The virtual address is extended with the contents of the 8-bit ASID field to form a unique virtual address. This mapped space starts at virtual address 0x0000 0000 0000 0000 and runs through 0x0000 00FF FFFF FFFF.

(4) xsseg (64-bit Supervisor mode, current supervisor space)

When $SX = 1$ in the Status register and bits 63 and 62 of the virtual address space are set to 01, the xsseg virtual address space is selected; it covers 1 Tbyte (2^{40} bytes) of the current supervisor virtual address space. The virtual address is extended with the contents of the 8-bit ASID field to form a unique virtual address. This mapped space begins at virtual address 0x4000 0000 0000 0000 and runs through 0x4000 00FF FFFF FFFF.

(5) csseg (64-bit Supervisor mode, separate supervisor space)

When $SX = 1$ in the Status register and bits 63 and 62 of the virtual address space are set to 11, the csseg virtual address space is selected; it covers 512 Mbytes (2^{29} bytes) of the separate supervisor virtual address space. The virtual address is extended with the contents of the 8-bit ASID field to form a unique virtual address. This mapped space begins at virtual address 0xFFFF FFFF C000 0000 and runs through 0xFFFF FFFF DFFF FFFF.

www.DataSheet4U.com

5.2.7 Kernel-mode Virtual Addressing

If the Status register satisfies any of the following conditions, the processor runs in Kernel mode.

- ◇ $KSU = 00$
- ◇ $EXL = 1$
- ◇ $ERL = 1$

The addressing width in Kernel mode varies according to the state of the KX bit of the Status register, as follows:

- ◇ When $KX = 0$, 32-bit kernel space is selected.
- ◇ When $KX = 1$, 64-bit kernel space is selected.

The processor enters Kernel mode whenever an exception is detected and it remains in Kernel mode until an exception return (ERET) instruction is executed and results in ERL and/or $EXL = 0$. The ERET instruction restores the processor to the mode existing prior to the exception.

Kernel mode virtual address space is divided into regions differentiated by the high-order bits of the virtual address, as shown in Figure 5-6. Table 5-3 lists the characteristics of the 32-bit Kernel mode segments, and Table 5-4 lists the characteristics of the 64-bit Kernel mode segments.

Figure 5-6. Kernel Mode Address Space

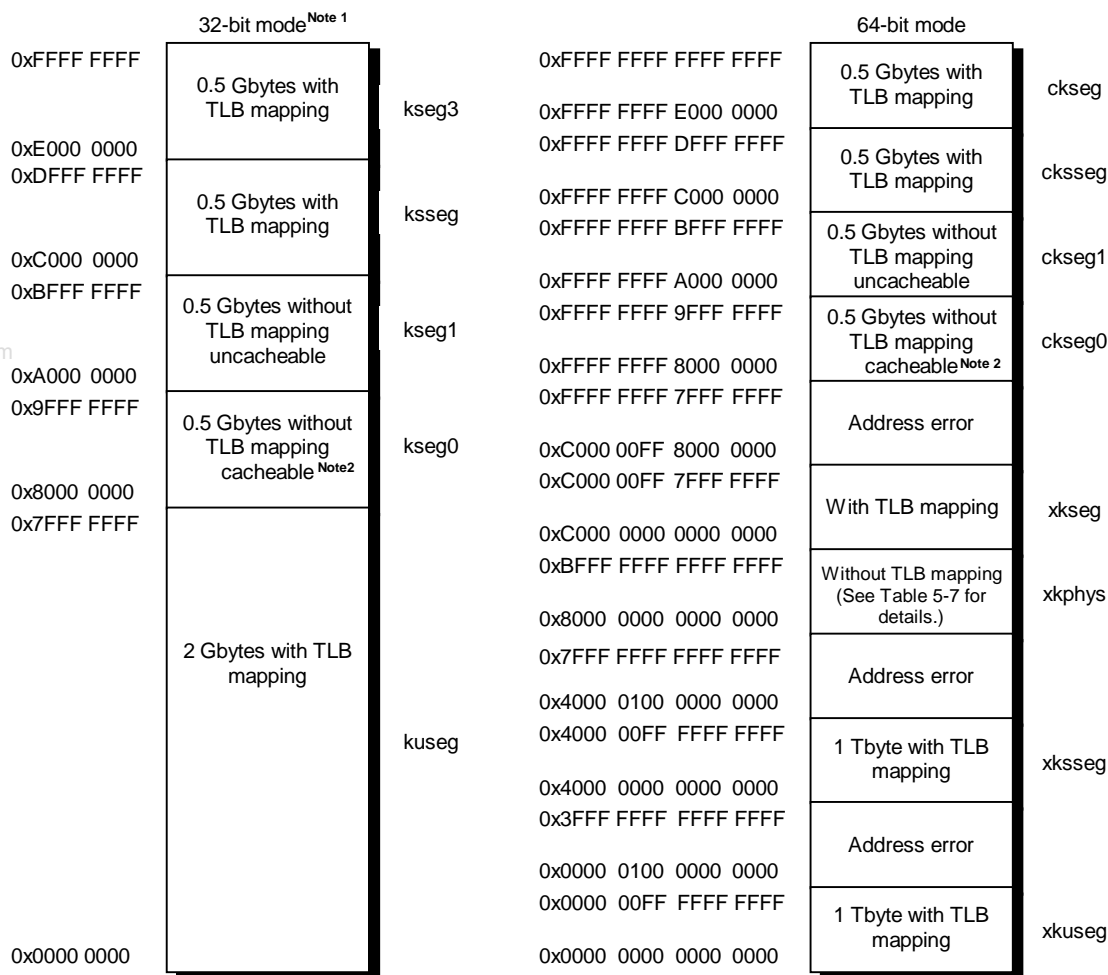

Notes 1. The VR4102 uses 64-bit addresses within it. For 32-bit mode addressing, bit 31 is sign-extended to bits 32 to 63, and the resulting 32 bits are used for addressing. Usually, a 64-bit instruction is used for the program in 32-bit mode. In an operation of base register + offset for addressing, however, a two's complement overflow may occur, causing an invalid address. Note that the result becomes undefined. Two factors that can cause a two's complement follow:

- ◇ When offset bit 15 is 0, base register bit 31 is 0, and bit 31 of the operation “base register + offset” is 1
- ◇ When offset bit 15 is 1, base register bit 31 is 1, and bit 31 of the operation “base register + offset” is 0

2. The K0 field of the Config register controls cacheability of kseg0 and ckseg0.

Figure 5-7. xkphys Area Address Space

0xBFFF FFFF FFFF FFFF	Address error
0xB800 0001 0000 0000	4 Gbytes without TLB mapping cacheable
0xB800 0000 FFFF FFFF	
0xB800 0000 0000 0000	Address error
0xB7FF FFFF FFFF FFFF	
0xB000 0001 0000 0000	4 Gbytes without TLB mapping cacheable
0xB000 0000 FFFF FFFF	
0xB000 0000 0000 0000	Address error
0xAFFF FFFF FFFF FFFF	
0xA800 0001 0000 0000	4 Gbytes without TLB mapping cacheable
0xA800 0000 FFFF FFFF	
0xA800 0000 0000 0000	Address error
0xA7FF FFFF FFFF FFFF	
0xA000 0001 0000 0000	4 Gbytes without TLB mapping cacheable
0xA000 0000 FFFF FFFF	
0xA000 0000 0000 0000	Address error
0x9FFF FFFF FFFF FFFF	
0x9800 0001 0000 0000	4 Gbytes without TLB mapping cacheable
0x9800 0000 FFFF FFFF	
0x9800 0000 0000 0000	Address error
0x97FF FFFF FFFF FFFF	
0x9000 0001 0000 0000	4 Gbytes without TLB mapping cacheable
0x9000 0000 FFFF FFFF	
0x9000 0000 0000 0000	Address error
0x8FFF FFFF FFFF FFFF	
0x8800 0001 0000 0000	4 Gbytes without TLB mapping cacheable
0x8800 0000 FFFF FFFF	
0x8800 0000 0000 0000	Address error
0x87FF FFFF FFFF FFFF	
0x8000 0001 0000 0000	4 Gbytes without TLB mapping cacheable
0x8000 0000 FFFF FFFF	
0x8000 0000 0000 0000	

Table 5-3. 32-bit Kernel Mode Segments

Address bit value	Status register bit value				Segment name	Virtual address	Physical address	Size
	KSU	EXL	ERL	KX				
32-bit A[31] = 0	KSU = 00 or EXL = 1 or ERL = 1		0	0	kuseg	0x0000 0000 to 0x7FFF FFFF	TLB map	2 Gbytes (2 ³¹ bytes)
32-bit A[31..29] = 100					kseg0	0x8000 0000 to 0x9FFF FFFF	0x0000 0000 to 0x1FFF FFFF	512 Mbytes (2 ²⁹ bytes)
32-bit A[31..29] = 101					kseg1	0xA000 0000 to 0xBFFF FFFF	0x0000 0000 to 0x1FFF FFFF	512 Mbytes (2 ²⁹ bytes)
32-bit A[31..29] = 110					ksseg	0xC000 0000 to 0xDFFF FFFF	TLB map	512 Mbytes (2 ²⁹ bytes)
32-bit A[31..29] = 111					kseg3	0xE000 0000 to 0xFFFF FFFF	TLB map	512 Mbytes (2 ²⁹ bytes)

(1) kuseg (32-bit Kernel mode, user space)

When KX = 0 in the Status register, and the most-significant bit of the virtual address space is 0, the kuseg virtual address space is selected; it is the current 2-Gbyte (2³¹-byte) user address space.

The virtual address is extended with the contents of the 8-bit ASID field to form a unique virtual address.

References to kuseg are mapped through TLB. Whether cache can be used or not is determined by bit C of each page's TLB entry.

If the ERL bit of the Status register is 1, the user address space is assigned 2 Gbytes (2³¹ bytes) without TLB mapping and becomes unmapped (with virtual addresses being used as physical addresses) and uncached so that the cache error handler can use it. This allows the Cache Error exception code to operate uncached using r0 as a base register.

(2) kseg0 (32-bit Kernel mode, kernel space 0)

When KX = 0 in the Status register and the most-significant three bits of the virtual address space are 100, the kseg0 virtual address space is selected; it is the current 512-Mbyte (2²⁹-byte) physical space.

References to kseg0 are not mapped through TLB; the physical address selected is defined by subtracting 0x8000 0000 from the virtual address.

The K0 field of the Config register controls cacheability (see **CHAPTER 6 EXCEPTION PROCESSING**).

(3) kseg1 (32-bit Kernel mode, kernel space 1)

When $KX = 0$ in the Status register and the most-significant three bits of the virtual address space are 101, the kseg1 virtual address space is selected; it is the current 512-Mbyte (2^{29} -byte) physical space.

References to kseg1 are not mapped through TLB; the physical address selected is defined by subtracting 0xA000 0000 from the virtual address.

Caches are disabled for accesses to these addresses, and main memory (or memory-mapped I/O device registers) is accessed directly.

(4) ksseg (32-bit Kernel mode, supervisor space)

When $KX = 0$ in the Status register and the most-significant three bits of the virtual address space are 110, the ksseg virtual address space is selected; it is the current 512-Mbyte (2^{29} -byte) virtual address space. The virtual address is extended with the contents of the 8-bit ASID field to form a unique virtual address.

References to ksseg are mapped through TLB. Whether cache can be used or not is determined by bit C of each page's TLB entry.

(5) kseg3 (32-bit Kernel mode, kernel space 3)

When $KX = 0$ in the Status register and the most-significant three bits of the virtual address space are 111, the kseg3 virtual address space is selected; it is the current 512-Mbyte (2^{29} -byte) kernel virtual space. The virtual address is extended with the contents of the 8-bit ASID field to form a unique virtual address.

References to kseg3 are mapped through TLB. Whether cache can be used or not is determined by bit C of each page's TLB entry.

Table 5-4. 64-bit Kernel Mode Segments

Address bit value	Status register bit value				Segment name	Virtual address	Physical address	Size
	KSU	EXL	ERL	KX				
64-bit A[63..62] = 00	KSU = 00 or EXL = 1 or ERL = 1	1	xkuseg	0x0000 0000 0000 0000 to 0x0000 00FF FFFF FFFF	TLB map	1 Tbyte (2 ⁴⁰ bytes)		
64-bit A[63..62] = 01			xksseg	0x4000 0000 0000 0000 to 0x4000 00FF FFFF FFFF	TLB map	1 Tbyte (2 ⁴⁰ bytes)		
64-bit A[63..62] = 10			xkphys	0x8000 0000 0000 0000 to 0xBFFF FFFF FFFF FFFF	0x0000 0000 to 0xFFFF FFFF	4 Gbytes (2 ³² bytes)		
64-bit A[63..62] = 11			xkseg	0xC000 0000 0000 0000 to 0xC000 00FF 7FFF FFFF	TLB map	2 ⁴⁰ - 2 ³¹ bytes		
64-bit A[63..62] = 11 A[63..31] = -1			ckseg0	0xFFFF FFFF 8000 0000 to 0xFFFF FFFF 9FFF FFFF	0x0000 0000 to 0x1FFF FFFF	512 Mbytes (2 ²⁹ bytes)		
64-bit A[63..62] = 11 A[63..31] = -1			ckseg1	0xFFFF FFFF A000 0000 to 0xFFFF FFFF BFFF FFFF	0x0000 0000 to 0x1FFF FFFF	512 Mbytes (2 ²⁹ bytes)		
64-bit A[63..62] = 11 A[63..31] = -1			cksseg	0xFFFF FFFF C000 0000 to 0xFFFF FFFF DFFF FFFF	TLB map	512 Mbytes (2 ²⁹ bytes)		
64-bit A[63..62] = 11 A[63..31] = -1			ckseg3	0xFFFF FFFF E000 0000 to 0xFFFF FFFF FFFF FFFF	TLB map	512 Mbytes (2 ²⁹ bytes)		

(6) xkuseg (64-bit Kernel mode, user space)

When KX = 1 in the Status register and bits 63 and 62 of the virtual address space are 00, the xkuseg virtual address space is selected; it is the 1-Tbyte (2⁴⁰ bytes) current user address space. The virtual address is extended with the contents of the 8-bit ASID field to form a unique virtual address.

References to xkuseg are mapped through TLB. Whether cache can be used or not is determined by bit C of each page's TLB entry.

If the ERL bit of the Status register is 1, the user address space is assigned 2 Gbytes (2³¹ bytes) without TLB mapping and becomes unmapped (with virtual addresses being used as physical addresses) and uncached so that the cache error handler can use it. This allows the Cache Error exception code to operate uncached using r0 as a base register.

(7) xksseg (64-bit Kernel mode, current supervisor space)

When KX = 1 in the Status register and bits 63 and 62 of the virtual address space are 01, the xksseg address space is selected; it is the 1-Tbyte (2⁴⁰ bytes) current supervisor address space. The virtual address is extended with the contents of the 8-bit ASID field to form a unique virtual address.

References to xksseg are mapped through TLB. Whether cache can be used or not is determined by bit C of each page's TLB entry.

(8) xkphys (64-bit Kernel mode, physical spaces)

When the KX = 1 in the Status register and bits 63 and 62 of the virtual address space are 10, the virtual address space is called xkphys and selected as either cached or uncached. If any of bits 58 to 32 of the address is 1, an attempt to access that address results in an address error.

Whether cache can be used or not is determined by bits 59 to 61 of the virtual address. Table 5-5 shows cacheability corresponding to 8 address spaces.

Table 5-5. Cacheability and the xkphys Address Space

Bits 61-59	Cacheability	Start address
0	Cached	0x8000 0000 0000 0000 to 0x8000 0000 FFFF FFFF
1	Cached	0x8800 0000 0000 0000 to 0x8800 0000 FFFF FFFF
2	Uncached	0x9000 0000 0000 0000 to 0x9000 0000 FFFF FFFF
3	Cached	0x9800 0000 0000 0000 to 0x9800 0000 FFFF FFFF
4	Cached	0xA000 0000 0000 0000 to 0xA000 0000 FFFF FFFF
5	Cached	0xA800 0000 0000 0000 to 0xA800 0000 FFFF FFFF
6	Cached	0xB000 0000 0000 0000 to 0xB000 0000 FFFF FFFF
7	Cached	0xB800 0000 0000 0000 to 0xB800 0000 FFFF FFFF

(9) xkseg (64-bit Kernel mode, physical spaces)

When the KX = 1 in the Status register and bits 63 and 62 of the virtual address space are 11, the virtual address space is called xkseg and selected as either of the following:

- kernel virtual space, xkseg, the current kernel virtual space; the virtual address is extended with the contents of the 8-bit ASID field to form a unique virtual address
References to xkseg are mapped through TLB. Whether cache can be used or not is determined by bit C of each page's TLB entry.
- one of the four 32-bit kernel compatibility spaces, as described in the next section.

(10) 64-bit Kernel mode compatible spaces (ckseg0, ckseg1, cksseg, and ckseg3)

If the conditions listed below are satisfied in Kernel mode, ckseg0, ckseg1, cksseg, or ckseg3 (each having 512 Mbytes) is selected as a compatible space according to the state of the bits 30 and 29 (two low-order bits) of the address.

- ◇ The KX bit of the Status register is 1.
- ◇ Bits 63 and 62 of the 64-bit virtual address are 11.
- ◇ Bits 61 to 31 of the virtual address are all 1.

(i) ckseg0

This space is an unmapped region, compatible with the 32-bit mode kseg0 space. The K0 field of the Config register controls cacheability and coherency.

(ii) ckseg1

This space is an unmapped and uncached region, compatible with the 32-bit mode kseg1 space.

(iii) cksseg

This space is the current supervisor virtual space, compatible with the 32-bit mode ksseg space. References to cksseg are mapped through TLB. Whether cache can be used or not is determined by bit C of each page's TLB entry.

(iv) ckseg3

This space is the current supervisor virtual space, compatible with the 32-bit mode kseg3 space. References to ckseg3 are mapped through TLB. Whether cache can be used or not is determined by bit C of each page's TLB entry.

5.3 PHYSICAL ADDRESS SPACE

Using a 32-bit address, the processor physical address space encompasses 4 Gbytes. The Vr4102 uses this 4-Gbyte physical address space as shown in Figure 5-8.

Figure 5-8. Vr4102 Physical Address Space

0xFFFF FFFF	(Mirror Image of 0x0000 0000 to 0x1FFF FFFF)
0x2000 0000 0x1FFF FFFF	ROM Area (Include Boot ROM)
0x1800 0000 0x17FF FFFF	System Bus I/O Area (ISA-IO)
0x1400 0000 0x13FF FFFF	System Bus I/O Area (ISA-MEM)
0x1000 0000 0x0FFF FFFF	RFU
0x0D00 0000 0x0CFF FFFF	Internal I/O Area 1
0x0C00 0000 0x0BFF FFFF	Internal I/O Area 2
0x0B00 0000 0x0AFF FFFF	LCD/High-Speed System Bus Area
0x0A00 0000 0x09FF FFFF	RFU
0x0400 0000 0x03FF FFFF	DRAM Area
0x0000 0000	

Table 5-6. VR4102 Physical Address Space

Physical address	Space	Capacity (bytes)
0xFFFF FFFF to 0x2000 0000	Mirror image of 0x1FFF FFFF to 0x0000 0000	3.5 G
0x1FFF FFFF to 0x1800 0000	ROM space	128 M
0x17FF FFFF to 0x1400 0000	System bus I/O space (ISA-IO)	64 M
0x13FF FFFF to 0x1000 0000	System bus memory space (ISA-MEM)	64 M
0x0FFF FFFF to 0x0D00 0000	Space reserved for future use	48 M
0x0CFF FFFF to 0x0C00 0000	Internal I/O space 1	16 M
0x0BFF FFFF to 0x0B00 0000	Internal I/O space 2	16 M
0x0AFF FFFF to 0x0A00 0000	LCD/high-speed system bus memory space	16 M
0x09FF FFFF to 0x0400 0000	Space reserved for future use	96 M
0x03FF FFFF to 0x0000 0000	DRAM space	64 M

5.3.1 ROM Space

The ROM space differs depending on the data bus' bit width and the capacity of the ROM being used.

- The data bus' bit width is set via the DBUS32 pin.
- The ROM capacity is set via the BCUNTRREG1's ROM64 bit.

The physical addresses of the ROM space are listed below.

Table 5-7. ROM Addresses (when using 16-bit data bus)

Physical address	ADD[25:0] pin	When using 32-M ROM	When using 64-M ROM
0x1FFF FFFF to 0x1FC0 0000	0x3FF FFFF to 0x3C0 0000	Bank 3 (ROMCS[3]#)	Bank 3 (ROMCS[3]#)
0x1FBF FFFF to 0x1F80 0000	0x3BF FFFF to 0x380 0000	Bank 2 (ROMCS[2]#)	
0x1F7F FFFF to 0x1F40 0000	0x37F FFFF to 0x340 0000	Bank 1 (ROMCS[1]#)	Bank 2 (ROMCS[2]#)
0x1F3F FFFF to 0x1F00 0000	0x33F FFFF to 0x300 0000	Bank 0 (ROMCS[0]#)	
0x1EFF FFFF to 0x1E80 0000	0x2FF FFFF to 0x280 0000	ROM space reserved for future use	Bank 1 (ROMCS[1]#)
0x1E7F FFFF to 0x1E00 0000	0x27F FFFF to 0x200 0000		Bank 0 (ROMCS[0]#)
0x1DFF FFFF to 0x1800 0000	0x1FF FFFF to 0x000 0000		ROM space reserved for future use

Table 5-8. ROM Addresses (when using 32-bit data bus)

Physical address	ADD[25:0] pin	When using 32-Mbit ROM	When using 64-Mbit ROM
0x1FFF FFFF to 0x1F80 0000	0x3FF FFFF to 0x380 0000	Bank 1 (ROMCS[1]#)	Bank 1 (ROMCS[1]#)
0x1F7F FFFF to 0x1F00 0000	0x37F FFFF to 0x300 0000	Bank 0 (ROMCS[0]#)	
0x1EFF FFFF to 0x1E00 0000	0x2FF FFF0 to 0x200 0000	ROM space reserved for future use	Bank 0 (ROMCS[0]#)
0x1DFF FFFF to 0x1800 0000	0x1FF FFFF to 0x000 0000		ROM space reserved for future use

5.3.2 System Bus Space

The following three types of system bus space are available.

- System bus I/O space

This corresponds to the ISA's I/O space.

- System bus memory space

This corresponds to the ISA's memory space.

- High-speed system bus memory space

The access speed can be set independently of the system bus memory space.

www.DataSheet4U.com

There are 16 Mbytes of high-speed system bus memory space. Therefore, the ADD[25:24] pin is fixed as 10.

When system bus memory has been accessed from the high-speed system bus memory space, the LCDCS# pin becomes active.

The high-speed system bus memory space is used exclusively from the LCD space. To switch between these two types of space, set the ISAM/LCD bit in BCUCNTREG1.

5.3.3 Internal I/O Space

The VR4102 has two internal I/O spaces. Each of these spaces are described below.

Table 5-9. Internal I/O Space 1

Physical address	Internal I/O
0x0CFF FFFF to 0x0C00 0060	Reserved for future use
0x0C00 005F to 0x0C00 0040	FIR
0x0C00 003F to 0x0C00 0020	HSP (Software modem interface)
0x0C00 001F to 0x0C00 0000	SIU (16550)

www.DataSheet4U.com

Table 5-10. Internal I/O Space 2

Physical address	Internal I/O
0x0BFF FFFF to 0x0B00 02C0	Reserved for future use
0x0B00 02BF to 0x0B00 02A0	PIU2
0x0B00 029F to 0x0B00 0280	Reserved for future use
0x0B00 027F to 0x0B00 0260	A/D test
0x0B00 025F to 0x0B00 0240	LED
0x0B00 023F to 0x0B00 0220	Reserved for future use
0x0B00 021F to 0x0B00 0200	ICU2
0x0B00 01FF to 0x0B00 01E0	Reserved for future use
0x0B00 01DF to 0x0B00 01C0	RTC2
0x0B00 01BF to 0x0B00 01A0	DSIU
0x0B00 019F to 0x0B00 0180	KIU1
0x0B00 017F to 0x0B00 0160	AIU
0x0B00 015F to 0x0B00 0140	Reserved for future use
0x0B00 013F to 0x0B00 0120	PIU1
0x0B00 011F to 0x0B00 0100	GIU1
0x0B00 00FF to 0x0B00 00E0	DSU
0x0B00 00DF to 0x0B00 00C0	RTC1
0x0B00 00BF to 0x0B00 00A0	PMU
0x0B00 009F to 0x0B00 0080	ICU1
0x0B00 007F to 0x0B00 0060	CMU
0x0B00 005F to 0x0B00 0040	DCU
0x0B00 003F to 0x0B00 0020	DMAAU
0x0B00 001F to 0x0B00 0000	BCU

5.3.4 LCD Space

This space is used to access the external LCD controller.

All data that is accessed via this space is inverted-bit data.

The LCD space is used exclusively from the high-speed system bus memory space. To switch between these two types of space, set the ISAM/LCD bit in BCUCNTREG1.

5.3.5 DRAM Space

The DRAM space differs depending on the data bus' bit width and the capacity of the DRAM being used.

- The data bus' bit width is set via the DBUS32 pin.
- The DRAM capacity is set via the BCUCNTREG1's DRAM64 bit.

www.DataSheet4U.com

The physical addresses of the DRAM space are listed below.

Table 5-11. DRAM Addresses (when using 16-bit data bus)

Physical address	When using 16-Mbit DRAM	When using 64-Mbit DRAM
0x03FF FFFF to 0x0200 0000	DRAM space reserved for future use	DRAM space reserved for future use
0x01FF FFFF to 0x0180 0000		Bank 3 (MRAS[3]#/UUCAS#)
0x017F FFFF to 0x0100 0000		Bank 2 (MRAS[2]#/ULCAS#)
0x00FF FFFF to 0x0080 0000		Bank 1 (MRAS[1]#)
0x007F FFFF to 0x0060 0000	Bank 3 (MRAS[3]#/UUCAS#)	Bank 0 (MRAS[0]#)
0x005F FFFF to 0x0040 0000	Bank 2 (MRAS[2]#/ULCAS#)	
0x003F FFFF to 0x0020 0000	Bank 1 (MRAS[1]#)	
0x001F FFFF to 0x0000 0000	Bank 0 (MRAS[0]#)	

Table 5-12. DRAM Addresses (when using 32-bit data bus)

Physical address	When using 16-Mbit DRAM	When using 64-Mbit DRAM
0x03FF FFFF to 0x0200 0000	DRAM space reserved for future use	DRAM space reserved for future use
0x01FF FFFF to 0x0180 0000		Bank 1 (MRAS[1]#)
0x017F FFFF to 0x0100 0000		
0x00FF FFFF to 0x0080 0000		Bank 0 (MRAS[0]#)
0x007F FFFF to 0x0060 0000	Bank 1 (MRAS[1]#)	Bank 0 (MRAS[0]#)
0x005F FFFF to 0x0040 0000		
0x003F FFFF to 0x0020 0000	Bank 0 (MRAS[0]#)	
0x001F FFFF to 0x0000 0000		

5.4.1 Format of a TLB Entry

Figure 5-10 shows the TLB entry formats for both 32- and 64-bit modes. Each field of an entry has a corresponding field in the EntryHi, EntryLo0, EntryLo1, or PageMask registers.

Figure 5-10. Format of a TLB Entry

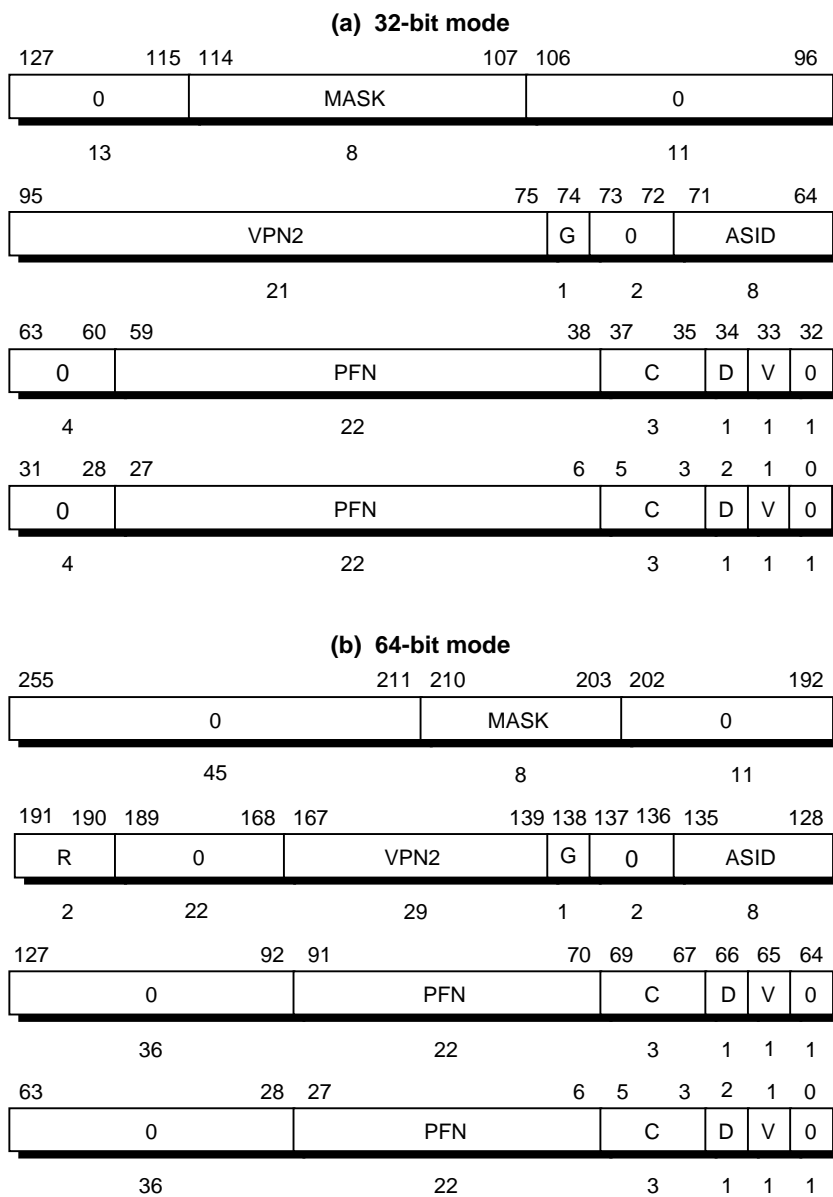

The format of the EntryHi, EntryLo0, EntryLo1, and PageMask registers are nearly the same as the TLB entry. However, it is unknown what bit of the EntryHi register corresponds to the TLB G bit.

Figure 5-11. Format of a TLB Entry (1/2)

(a) PageMask Register

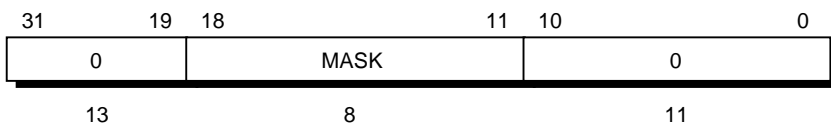

MASK : Page comparison mask, which determines the virtual page size for the corresponding entry.
 0 : Reserved for future use. Write 0 in a write operation. When this field is read, 0 is read.

www.DataSheet4U.com

(b) EntryHi Register

(a) 32-bit mode

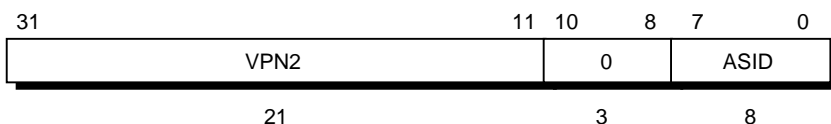

(b) 64-bit mode

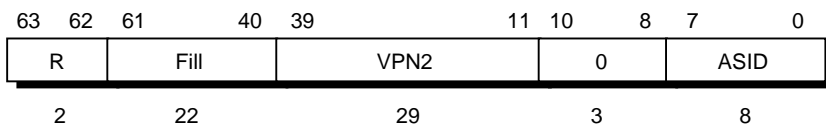

VPN2: Virtual page number divided by two (mapping to two pages)
 ASID : Address space ID. An 8-bit ASID field that lets multiple processes share the TLB; each process has a distinct mapping of otherwise identical virtual page numbers.
 R : Space type (00 → user, 01 → supervisor, 11 → kernel). Matches bits 63 and 62 of the virtual address.
 Fill : Reserved. Ignored on write. When read, returns zero.
 0 : Reserved for future use. Write 0 in a write operation. When this field is read, 0 is read.

Figure 5-11. Format of a TLB Entry (2/2)

(c) EntryLo0 and EntryLo1 Registers

(a) 32-bit mode

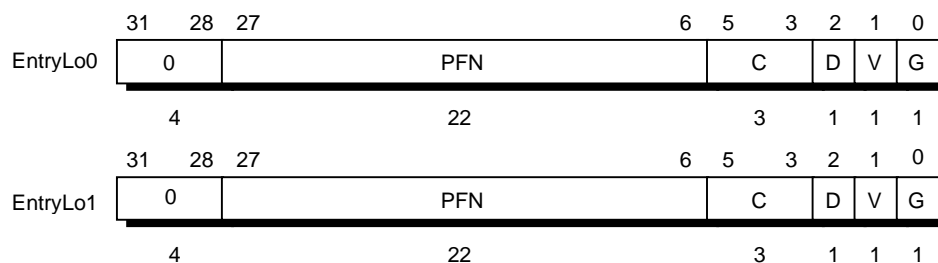

(b) 64-bit mode

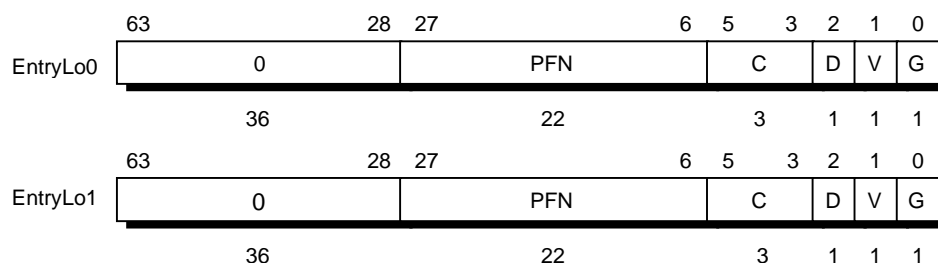

- PFN : Page frame number; high-order bits of the physical address.
- C : Specifies the TLB page attribute.
- D : Dirty. If this bit is set to 1, the page is marked as dirty and, therefore, writable. This bit is actually a write-protect bit that software can use to prevent alteration of data.
- V : Valid. If this bit is set to 1, it indicates that the TLB entry is valid; otherwise, a TLB Invalid exception (TLBL or TLBS) occurs.
- G : Global. If this bit is set in both EntryLo0 and EntryLo1, then the processor ignores the ASID during TLB lookup.
- 0 : Reserved for future use. Write 0 in a write operation. When this field is read, 0 is read.

The coherency attribute (C) bits are used to specify whether to use the cache in referencing a page. When the cache is used, whether the page attribute is “cached” or “uncached” is selected by algorithm.

Table 5-13 lists the page attributes selected according to the value in the C bits.

Table 5-13. Cache Algorithm

C bit value	Cache algorithm
0	Cached
1	Cached
2	Uncached
3	Cached
4	Cached
5	Cached
6	Cached
7	Cached

5.5 CP0 REGISTERS

The CP0 registers explained below are accessed by the memory management system and software. A parenthesized number that follows each register name is a register number.

5.5.1 Index Register (0)

The Index register is a 32-bit, read/write register containing five bits to index an entry in the TLB. The most-significant bit of the register shows the success or failure of a TLB probe (TLBP) instruction.

The Index register also specifies the TLB entry affected by TLB read (TLBR) or TLB write index (TLBWI) instructions.

www.DataSheet4U.com

Figure 5-12. Index Register

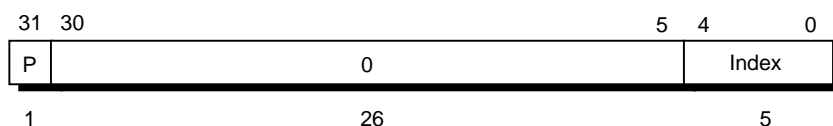

P : Indicates whether probing is successful or not. It is set to 1 if the latest TLBP instruction fails. It is cleared to 0 when the TLBP instruction is successful.

Index : Specifies an index to a TLB entry that is a target of the TLBR or TLBWI instruction.

0 : Reserved for future use. Write 0 in a write operation. When this field is read, 0 is read.

5.5.2 Random Register (1)

The Random register is a read-only register. The low-order 5 bits are used in referencing a TLB entry. This register is decremented each time an instruction is executed. The values that can be set in the register are as follows:

- ✧ The lower bound is the content of the Wired register.
- ✧ The upper bound is 31.

The Random register specifies the entry in the TLB that is affected by the TLBWR instruction. The register is readable to verify proper operation of the processor.

The Random register is set to the value of the upper bound upon Cold Reset. This register is also set to the upper bound when the Wired register is written. Figure 5-13 shows the format of the Random register.

Figure 5-13. Random Register

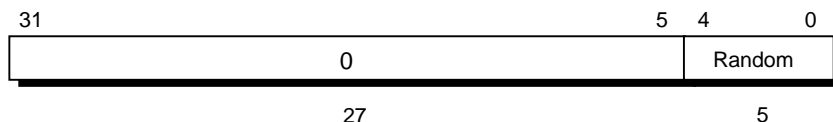

Random : TLB random index

0 : Reserved for future use. Write 0 in a write operation. When this field is read, 0 is read.

5.5.3 EntryHi (10), EntryLo0 (2), EntryLo1 (3), and PageMask (5) Registers

These registers are used in address translation, to rewrite TLB or to find match of TLB entry. When a TLB exception occurs, the information of the address that causes the exception is loaded into these registers. For the formats of these registers, see Figure 5-11.

(1) EntryHi Register (10)

The EntryHi register is read/write-accessible. It is used to access the high-order bits of built-in TLB. The EntryHi register holds the high-order bits of a TLB entry for TLB read and write operations. If a TLB Mismatch, TLB Invalid, or TLB Modified exception occurs, the EntryHi register sets the virtual page number (VPN2) for a virtual address where an exception occurred and the ASID. See Chapter 6 for details of the TLB exception.

The ASID is used to read from or write to the ASID field of the TLB entry. It is also checked with the ASID of the TLB entry as the ASID of the virtual address during address translation.

The EntryHi register is accessed by the TLBP, TLBWR, TLBWI, and TLBR instructions.

(2) EntryLo0 (2) and EntryLo1 (3) Registers

The EntryLo register consists of two registers that have identical formats: EntryLo0, used for even virtual pages and EntryLo1, used for odd virtual pages. The EntryLo0 and EntryLo1 registers are both read-/write-accessible. They are used to access the low-order bits of the built-in TLB. When a TLB read/write operation is carried out, the EntryLo0 and EntryLo1 registers hold the contents of the low-order 32 bits of TLB entries at even and odd addresses, respectively.

(3) PageMask Register (5)

The PageMask register is a read/write register used for reading from or writing to the TLB; it holds a comparison mask that sets the five types of page sizes for each TLB entry, as shown in Table 5-14. Page sizes must be from 1 Kbyte to 256 Kbytes.

TLB read and write instructions use this register as either a source or a destination; Bits 18 to 11 that are targets of comparison are masked during address translation.

Table 5-14 lists the mask pattern for each page size. If the mask pattern is one not listed below, the TLB behaves unexpectedly.

Table 5-14. Mask Values and Page Sizes

Page size	Bit							
	18	17	16	15	14	13	12	11
1 Kbyte	0	0	0	0	0	0	0	0
4 Kbytes	0	0	0	0	0	0	1	1
16 Kbytes	0	0	0	0	1	1	1	1
64 Kbytes	0	0	1	1	1	1	1	1
256 Kbytes	1	1	1	1	1	1	1	1

5.5.4 Wired Register (6)

The Wired register is a read/write register that specifies the lower boundary of the random entry of the TLB as shown in Figure 5-14. Wired entries cannot be overwritten by a TLBWR instruction. They can, however, be overwritten by a TLBWI instruction. Random entries can be overwritten by both instructions.

Figure 5-14. Positions Indicated by the Wired Register

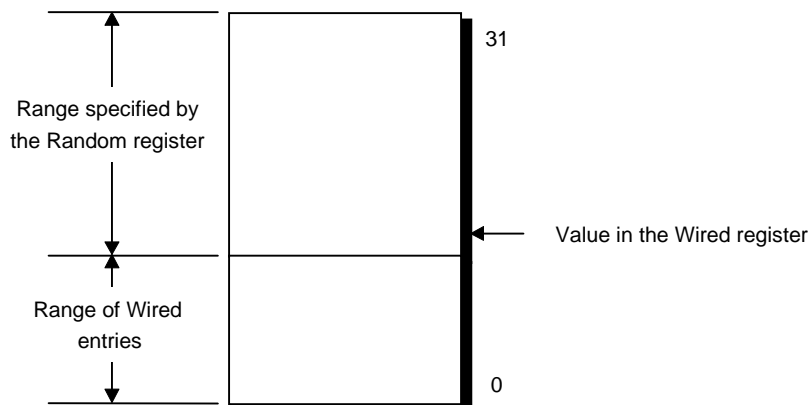

The Wired register is set to 0 upon Cold Reset. Writing this register also sets the Random register to the value of its upper bound (see 5.5.2 Random register (1)). Figure 5-15 shows the format of the Wired register.

Figure 5-15. Wired Register

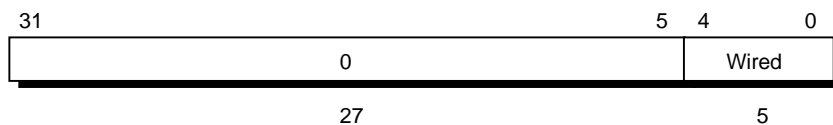

Wired : TLB wired boundary

0 : Reserved for future use. Write 0 in a write operation. When this field is read, 0 is read.

5.5.5 Processor Revision Identifier (PRId) Register (15)

The 32-bit, read-only Processor Revision Identifier (PRId) register contains information identifying the implementation and revision level of the CPU and CP0. Figure 5-16 shows the format of the PRId register.

Figure 5-16. PRId Register

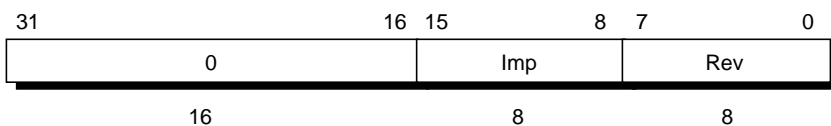

www.DataSheet4U.com

Imp : CPU core processor ID number (0x0C for the VR4102)

Rev : CPU core processor revision number

0 : Reserved for future use. Write 0 in a write operation. When this field is read, 0 is read.

The processor revision number is stored as a value in the form y.x, where y is a major revision number in bits 7 to 4 and x is a minor revision number in bits 3 to 0.

The processor revision number can distinguish some CPU core revisions, however there is no guarantee that changes to the CPU core will necessarily be reflected in the PRId register, or that changes to the revision number necessarily reflect real CPU core changes. Therefore, create a program that does not depend on the processor revision number area.

5.5.6 Config Register (16)

The Config register indicates and specifies various configuration options selected on Vr4102 processors.

Some configuration options, as defined by the EC and BE fields, are set by the hardware during Cold Reset and are included in the Config register as read-only status bits for the software to access. Other configuration options (AD, EP, and K0 fields) can be read/written and controlled by software; on Cold Reset these fields are undefined. Since only a subset of the Vr4000 options are available in the Vr4102, some bits are set to constants (e.g., bits 14:13) that were variable in the Vr4000. The Config register should be initialized by software before caches are used. Figure 5-17 shows the format of the Config register.

Figure 5-17. Config Register Format

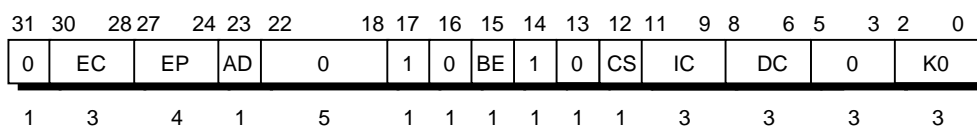

- EC : System interface clock ratio (read only)
 - 000 → Processor clock frequency divided by 2
 - Others → Reserved
- EP : Transfer data pattern (cache write-back pattern)
 - 0000 → DD: 1 word/1 cycle
 - Others → Reserved
- AD : Accelerate data mode setting
 - 0 → Vr4000 Series compatible mode
 - 1 → Reserved
- BE : BigEndianMem. Indicates endian.
 - 0 → Little endian
 - 1 → Reserved
- CS : Cache size mode indication
 - 0 → Reserved
 - 1 → Cache of small capacity
- IC : Instruction cache size indication. The size is $2^{(10+IC)}$ bytes when CS bit is set to 1.
 - 2 → 4 Kbytes
 - Others → Reserved
- DC : Data cache size indication. The size is $2^{(10+DC)}$ bytes when CS bit is set to 1.
 - 0 → 1 Kbytes
 - Others → Reserved
- K0 : kseg0 cache coherency algorithm
 - 010 → Uncached
 - Others → Cached
 - 1: 1 is returned when it is read.
 - 0: 0 is returned when it is read.

Caution The value that can be set is different from that of the VR4100. Be sure to set the EP field and the AD bit to 0. If they are set with any other values, the processor may behave unexpectedly.

5.5.7 Load Linked Address (LLAddr) Register (17)

The read/write Load Linked Address (LLAddr) register is a read/write register, and not used with the VR4102 processor except for diagnostic purpose, and serves no function during normal operation.

LLAddr register is implemented just for compatibility between the VR4102 and VR4000/VR4400.

Figure 5-18. LLAddr Register

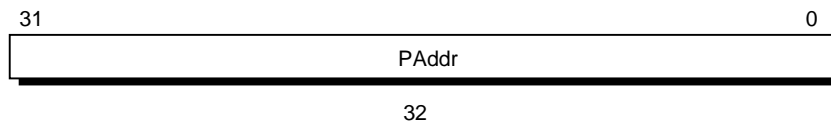

PAddr: 32-bit physical address

5.5.8 Cache Tag Registers (TagLo (28) and TagHi (29))

The TagLo and TagHi registers are 32-bit read/write registers that hold the primary cache tag and parity during cache initialization, cache diagnostics, or cache error processing. The Tag registers are written by the CACHE and MTC0 instructions.

The P fields of these registers are ignored on Index Store Tag operations by the CACHE instruction. Parity is computed by the store operation. Figure 5-19 shows the format of these registers.

Figure 5-19. TagLo and TagHi Registers

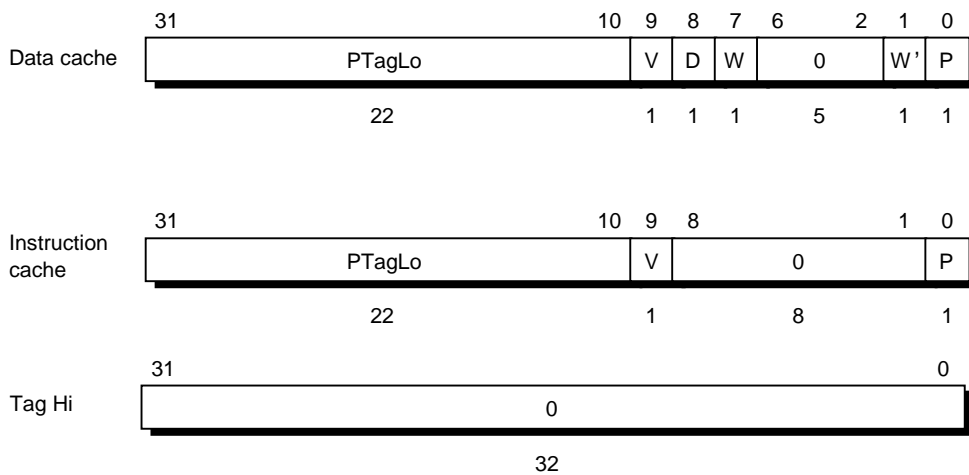

PTagLo: Specifies physical address bits 31 to 10.

V : Valid bit

D : Dirty bit. However, this bit is defined only for the compatibility with the VR4000 Series processors, and does not indicate the status of cache memory in spite of its readability and writability. This bit cannot change the status of cache memory.

W : Write-back bit (set if cache line has been updated)

W' : Even parity for the write-back bit

P : Even parity bit for primary cache tag

0 : Reserved for future use. Write 0 in a write operation. When this field is read, 0 is read.

5.5.9 Virtual-to-Physical Address Translation

During virtual-to-physical address translation, the CPU compares the 8-bit ASID (and while the Global bit, G, is not set to 1) of the virtual address to the ASID of the TLB entry to see if there is a match. One of the following comparisons are also made:

- ✧ In 32-bit mode, the high-order bits^{Note} of the 32-bit virtual address are compared to the contents of the VPN2 (virtual page number divided by two) of each TLB entry.
- ✧ In 64-bit mode, the high-order bits^{Note} of the 64-bit virtual address are compared to the contents of the R and the VPN2 (virtual page number divided by two) of each TLB entry.

If a TLB entry matches, the physical address and access control bits (C, D, and V) are retrieved from the matching TLB entry. While the V bit of the entry must be set to 1 for a valid address translation to take place, it is not involved in the determination of a matching TLB entry.

Figure 5-20 illustrates the TLB address translation flow.

Note The number of bits differs from page sizes. The table below shows the examples of high-order bits of the virtual address in page size of 256 Kbytes and 1 Kbytes.

Page size Mode	256 Kbytes	1 Kbytes
32-bit mode	bits 31 to 19	bits 31 to 11
64-bit mode	bits 63, 62, 39 to 19	bits 63, 62, 39 to 11

Figure 5-20. TLB Address Translation

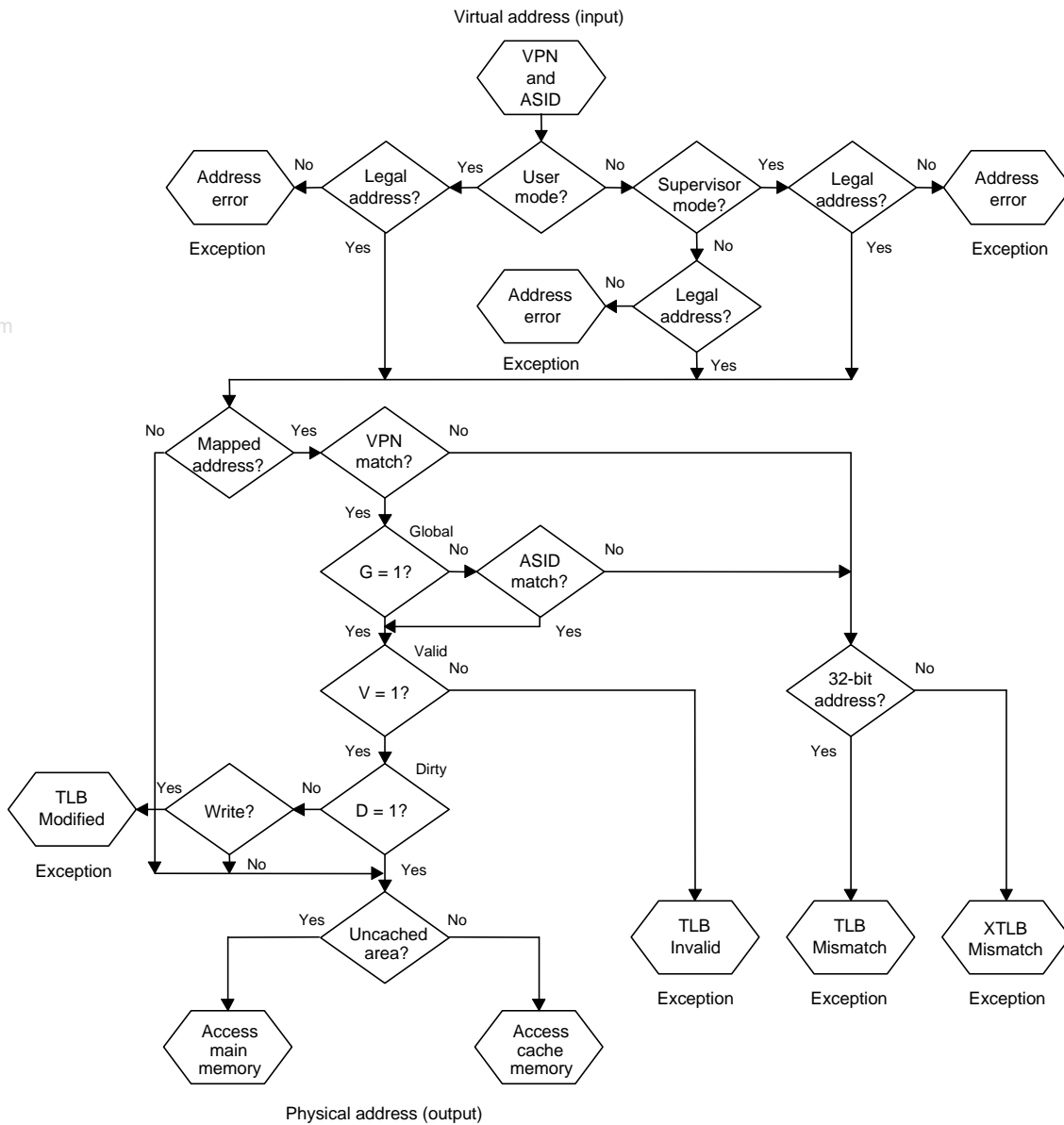

5.5.10 TLB Misses

If there is no TLB entry that matches the virtual address, a TLB Refill (miss) exception occurs^{Note}. If the access control bits (D and V) indicate that the access is not valid, a TLB Modified or TLB Invalid exception occurs. If the C bit is 010, the retrieved physical address directly accesses main memory, bypassing the cache.

Note See Chapter 6 for details of the TLB Miss exception.

5.5.11 TLB Instructions

The instructions used for TLB control are described below.

(1) Translation lookaside buffer probe (TLBP)

The translation lookaside buffer probe (TLBP) instruction loads the Index register with a TLB number that matches the content of the EntryHi register. If there is no TLB number that matches the TLB entry, the highest-order bit of the Index register is set.

(2) Translation lookaside buffer read (TLBR)

The translation lookaside buffer read (TLBR) instruction loads the EntryHi, EntryLo0, EntryLo1, and PageMask registers with the content of the TLB entry indicated by the content of the Index register.

(3) Translation lookaside buffer write index (TLBWI)

The translation lookaside buffer write index (TLBWI) instruction writes the contents of the EntryHi, EntryLo0, EntryLo1, and PageMask registers to the TLB entry indicated by the content of the Index register.

(4) Translation lookaside buffer write random (TLBWR)

The translation lookaside buffer write random (TLBWR) instruction writes the contents of the EntryHi, EntryLo0, EntryLo1, and PageMask registers to the TLB entry indicated by the content of the Random register.

[MEMO]

CHAPTER 6 EXCEPTION PROCESSING

This chapter describes CPU exception processing, including an explanation of hardware that processes exceptions, followed by the format and use of each CPU exception register.

The chapter concludes with a description of each exception's cause, together with the manner in which the CPU processes and services each exception.

6.1 HOW EXCEPTION PROCESSING WORKS

The processor receives exceptions from a number of sources, including translation lookaside buffer (TLB) misses, arithmetic overflows, I/O interrupts, and system calls. When the CPU detects an exception, the normal sequence of instruction execution is suspended and the processor enters Kernel mode (see Chapter 5 for a description of system operating modes).

The processor then disables interrupts and transfers control for execution to the exception handler (located at a specific address as an exception handling routine implemented by software). The handler saves the context of the processor, including the contents of the program counter, the current operating mode (User or Supervisor), statuses, and interrupt enabling. This context is saved so it can be restored when the exception has been serviced.

When an exception occurs, the CPU loads the Exception Program Counter (EPC) register with a location where execution can restart after the exception has been serviced. The restart location in the EPC register is the address of the instruction that caused the exception or, if the instruction was executing in a branch delay slot, the address of the branch instruction immediately preceding the delay slot.

The Vr4102 processor supports a Supervisor mode and fast TLB refill for all address spaces. The Vr4102 also provides the following functions:

- ◇ Interrupt enable (IE) bit
- ◇ Operating mode (User, Supervisor, or Kernel)
- ◇ Exception level (normal or exception is indicated by the EXL bit in the Status register)
- ◇ Error level (normal or error is indicated by the ERL bit in the Status register).

Interrupts are enabled when the following conditions are satisfied:

(1) Interrupt enable

An interrupt is enabled when the following conditions are satisfied.

- Interrupt enable bit (IE) = 1
- EXL bit = 0, ERL bit = 0
- Corresponding IM field bits in the Status register = 1

(2) Operating mode

The operating mode is specified by KSU bit in the Status register when both the exception level and error level are normal (0).

(3) Exception/error levels

The operation enters Kernel mode when either EXL bit or ERL bit in the Status register is set to 1. Returning from an exception resets the exception level to normal (0) (for details, see Chapter 27).

The registers that retain address, cause, and status information during exception processing are described in **6.3 EXCEPTION PROCESSING REGISTERS**. For a description of the exception process, see **6.4 DETAILS OF EXCEPTIONS**.

www.DataSheet4U.com

6.2 PRECISION OF EXCEPTIONS

V_R4102 exceptions are logically precise; the instruction that causes an exception and all those that follow it are aborted and can be re-executed after servicing the exception. When succeeding instructions are killed, exceptions associated with those instructions are also killed. Exceptions are not taken in the order detected, but in instruction fetch order.

There is a special case in which the V_R4102 processor may not be able to restart easily after servicing an exception. When a cache data parity error exception occurs on a load with a cache hit, the V_R4102 processor does not prevent the cache data (with erroneous parity) from being written back into the register file during the WB stage. The exception is still precise, since both the EPC and CacheError registers are updated with the correct virtual address pointing to the offending load instruction, and the exception handler can still determine the cause of exception and its origin. The program can be restarted by rewriting the destination register - not automatically, however, as in the case of all the other precise exceptions where no status change occurs.

6.3 EXCEPTION PROCESSING REGISTERS

This section describes the CP0 registers that are used in exception processing. Table 6-1 lists these registers, along with their number—each register has a unique identification number that is referred to as its register number. The CP0 registers not listed in the table are used in memory management (see Chapter 5 for details).

The exception handler examines the CP0 registers during exception processing to determine the cause of the exception and the state of the CPU at the time the exception occurred.

The registers in Table 6-1 are used in exception processing, and are described in the sections that follow.

Table 6-1. CP0 Exception Processing Registers

Register name	Register number
Context register	4
BadVAddr register	8
Count register	9
Compare register	11
Status register	12
Cause register	13
EPC register	14
WatchLo register	18
WatchHi register	19
XContext register	20
Parity Error register	26
Cache Error register	27
ErrorEPC register	30

6.3.1 Context Register (4)

The Context register is a read/write register containing the pointer to an entry in the page table entry (PTE) array on the memory; this array is a table that stores virtual-to-physical address translations. When there is a TLB miss, the operating system loads the unsuccessfully translated entry from the PTE array to the TLB. The Context register is used by the TLB Refill exception handler for loading TLB entries. The Context register duplicates some of the information provided in the BadVAddr register, but the information is arranged in a form that is more useful for a software TLB exception handler. Figure 6-1 shows the format of the Context register.

Figure 6-1. Context Register Format

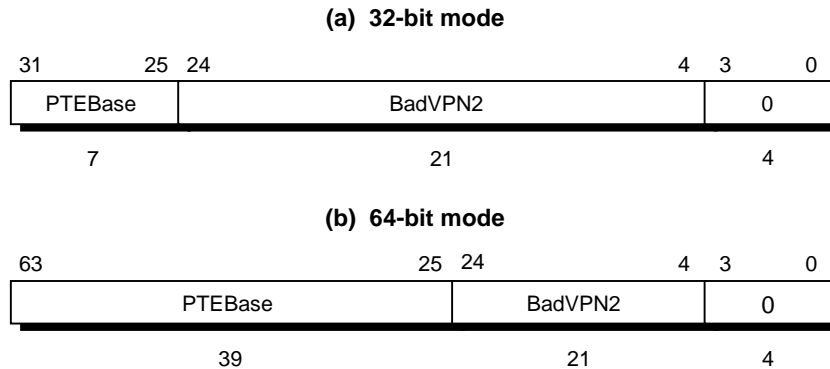

- PTEBase : The PTEBase field is a read/write field. It is used by software as the pointer to the base address of the PTE table in the current user address space.
- BadVPN2 : The BadVPN2 field is written by hardware if a TLB miss occurs. This field holds the value (VPN2) obtained by halving the virtual page number of the most recent virtual address for which translation failed.
- 0 : Reserved for future use. Write 0 in a write operation. When this field is read, 0 is read.

The 21-bit BadVPN2 field contains bits 31-11 of the virtual address that caused the TLB miss; bit 10 is excluded because a single TLB entry maps to an even-odd page pair. For a 1-Kbyte page size, this format can directly address the pair-table of 8-byte PTEs. When the page size is 4 Kbytes or more, shifting or masking this value produces the correct PTE reference address.

6.3.2 BadVAddr Register (8)

The Bad Virtual Address (BadVAddr) register is a read-only register that saves the most recent virtual address that failed to have a valid translation, or that had an addressing error. Figure 6-2 shows the format of the BadVAddr register.

Caution This register saves no information after a bus error exception, because it is not an address error exception.

Figure 6-2. BadVAddr Register Format

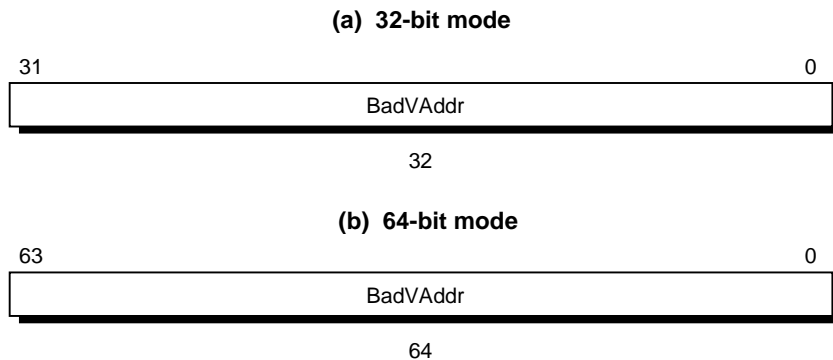

BadVAddr: Most recent virtual address for which an addressing error occurred, or for which address translation failed

6.3.3 Count Register (9)

The read/write Count register acts as a timer. It is incremented in synchronization with the MasterOut clock, regardless of whether instructions are being executed, retired, or any forward progress is actually made through the pipeline.

This register is a free-running type. When the register reaches all ones, it rolls over to zero and continues counting. This register is used for self-diagnostic test, system initialization, or the establishment of inter-process synchronization.

Figure 6-3 shows the format of the Count register.

Figure 6-3. Count Register Format

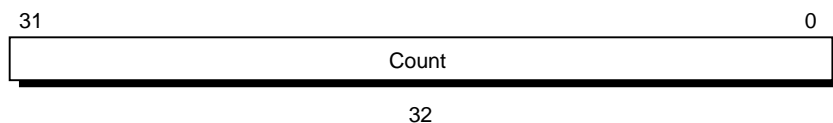

Count: 32-bit up-date count value that is compared with the value of the Compare register

6.3.4 Compare Register (11)

The Compare register causes a timer interrupt; it maintains a stable value that does not change on its own.

When the value of the Count register (see 6.3.3) equals the value of the Compare register, the IP(7) bit in the Cause register is set. This causes an interrupt as soon as the interrupt is enabled.

Writing a value to the Compare register, as a side effect, clears the timer interrupt request.

For diagnostic purposes, the Compare register is a read/write register. Normally, this register should be only used for a write. Figure 6-4 shows the format of the Compare register.

Figure 6-4. Compare Register Format

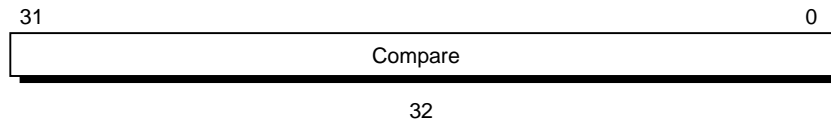

Compare: Value that is compared with the count value of the Count register

6.3.5 Status Register (12)

The Status register is a read/write register that contains the operating mode, interrupt enabling, and the diagnostic states of the processor. Figure 5-5 shows the format of the Status register. Figure 5-6 shows the details of the Diagnostic Status (DS) field. All DS field bits other than the TS bit are writable.

Figure 6-5. Status Register Format

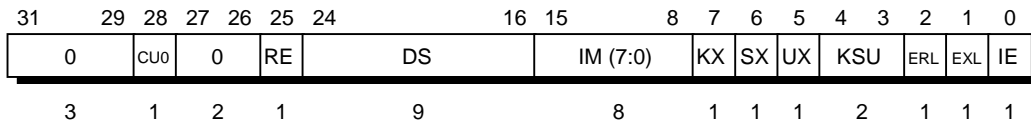

CU0 : Enables/disables the use of the coprocessor (1 → Enabled, 0 → Disabled).

CP0 can be used by the kernel at all times.

0 : Reserved for future use. Write 0 in a write operation. When this bit is read, 0 is read.

RE : Enables/disables reversing of the endian setting in User mode (0 → Disabled, 1 → Enabled). This bit must be set to 0 since the VR4102 supports the little-endian order only.

DS : Diagnostic Status field (see Figure 6-6).

IM : Interrupt Mask field used to enable/disable interrupts (0 → Disabled, 1 → Enabled). This field consists of 8 bits that are used to control eight interrupts. The bits are assigned to interrupts as follows:

IM7 : Masks a timer interrupt.

IM(6:2) : Mask ordinary interrupts (Int(4:0)^{Note}). However, Int4^{Note} never occur in the VR4102.

IM(1:0) : Mask software interrupts or Cause register IP(1:0).

Note Int(4:0) are internal signals of the VR4100 CPU core. For details about connection to the on-chip peripheral units, refer to Chapter 14.

- KX : Enables 64-bit addressing in Kernel mode (0 → 32-bit, 1 → 64-bit). If this bit is set, an XTLB Refill exception occurs if a TLB miss occurs in the Kernel mode address space.
- SX : Enables 64-bit addressing and operation in Supervisor mode (0 → 32-bit, 1 → 64-bit). If this bit is set, an XTLB Refill exception occurs if a TLB miss occurs in the Supervisor mode address space.
- UX: : Enables 64-bit addressing and operation in User mode (0 → 32-bit, 1 → 64-bit). If this bit is set, an XTLB Refill exception occurs if a TLB miss occurs in the User mode address space.
- KSU : Sets and indicates the operating mode (10 → User, 01 → Supervisor, 00 → Kernel).
- ERL : Sets and indicates the error level (0 → Normal, 1 → Error).
- EXL : Sets and indicates the exception level (0 → Normal, 1 → Exception).
- IE : Sets and indicates interrupt enabling/disabling (0 → Disabled, 1 → Enabled).

www.DataSheet4U.com

Figure 6-6. Status Register Diagnostic Status Field

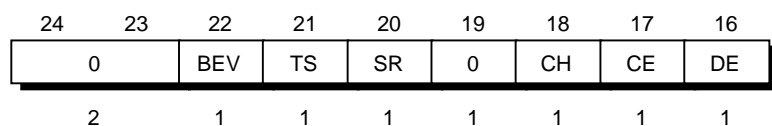

- BEV : Specifies the base address of a TLB Refill exception vector and common exception vector (0 → Normal, 1 → Bootstrap).
- TS : Occurs the TLB to be shut down (read-only) (0 → Not shut down, 1 → Shut down). This bit is used to avoid any problems that may occur when multiple TLB entries match the same virtual address. After the TLB has been shut down, reset the processor to enable restart. Note that the TLB is shut down even if a TLB entry matching a virtual address is marked as being invalid (with the V bit cleared).
- SR : Occurs a Soft Reset or NMI exception (0 → Not occurred, 1 → Occurred).
- CH : CP0 condition bit (0 → False, 1 → True). This bit can be read and written by software only; it cannot be accessed by hardware.
- CE : When CE = 1, the contents of the PErr register are written to the check bits of the cache (See 6.3.10)
- DE : Specifies whether a cache parity error causes an exception (0 → Enable parity check, 1 → Disable parity check).
- 0 : Reserved for future use. Write 0 in a write operation. When this field is read, 0 is read.

The status register has the following fields where the modes and access status are set.

(1) Interrupt enable

Interrupts are enabled when all of the following conditions are true:

- ✧ IE is set to 1.
- ✧ EXL is cleared to 0.
- ✧ ERL is cleared to 0.
- ✧ The appropriate bit of the IM is set to 1.

(2) Operating modes

The following Status register bit settings are required for User, Kernel, and Supervisor modes.

- ✧ The processor is in User mode when KSU = 10, EXL = 0, and ERL = 0.
- ✧ The processor is in Supervisor mode when KSU = 01, EXL = 0, and ERL = 0.
- ✧ The processor is in Kernel mode when KSU = 00, EXL = 1, or ERL = 1.

(3) 32- and 64-bit modes

The following Status register bit settings select 32- or 64-bit operation for User, Kernel, and Supervisor operating modes. Enabling 64-bit operation permits the execution of 64-bit opcodes and translation of 64-bit addresses. 64-bit operation for User, Kernel and Supervisor modes can be set independently.

- ✧ 64-bit addressing for Kernel mode is enabled when KX bit = 1. 64-bit operations are always valid in Kernel mode.
- ✧ 64-bit addressing and operations are enabled for Supervisor mode when SX bit = 1.
- ✧ 64-bit addressing and operations are enabled for User mode when UX bit = 1.

(4) Kernel address space accesses

Access to the kernel address space is allowed when the processor is in Kernel mode.

(5) Supervisor address space accesses

Access to the supervisor address space is allowed when the processor is in Supervisor or Kernel mode.

(6) User address space accesses

Access to the user address space is allowed in any of the three operating modes.

(7) Status after reset

The contents of the Status register are undefined after resets, except for the following bits.

- TS and SR are cleared to 0.
- ERL and BEV are set to 1.
- SR is 0 after Cold reset, and is 1 after Soft reset or NMI interrupt.

Remark Cold reset and Soft reset are CPU core reset (see **7.4 RESET OF THE CPU CORE**). For the reset of all the V_R4102 including peripheral units, refer to **CHAPTER 7 INITIALIZATION INTERFACE** and **CHAPTER 15 PMU**.

6.3.6 Cause Register (13)

The 32-bit read/write Cause register holds the cause of the most recent exception. A 5-bit exception code indicates one of the causes (see Table 6-2). Other bits holds the detailed information of the specific exception. All bits in the Cause register, with the exception of the IP1 and IP0 bits, are read-only; IP1 and IP0 are used for software interrupts. Figure 6-7 shows the fields of this register; Table 6-2 describes the Cause register codes.

Figure 6-7. Cause Register Format

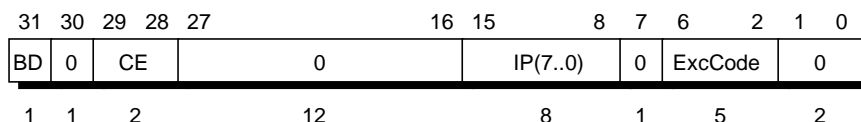

- BD : Indicates whether the most recent exception occurred in the branch delay slot (1 → In delay slot, 0 → Normal).
- CE : Indicates the coprocessor number in which a Coprocessor Unusable exception occurred. This field will remain undefined for as long as no exception occurs.
- IP : Indicates whether an interrupt is pending (1 → Interrupt pending, 0 → No interrupt pending).
 - IM7 : A timer interrupt.
 - IM(6:2) : Ordinary interrupts (Int(4:0)^{Note}). However, Int4^{Note} never occurs in the VR4102.
 - IM(1:0) : Software interrupts. Only these bits cause an interrupt exception, when they are set to 1 by means of software.

Note Int(4:0) are internal signals of the VR4100 CPU core. For details about connection to the on-chip peripheral units, refer to Chapter 14.

ExcCode: Exception code field (refer to Table 6-2 for details)

0 : Reserved for future use. Write 0 in a write operation. When this field is read, 0 is read.

Table 6-2. Cause Register Exception Code Field

Exception code	Mnemonic	Description
0	Int	Interrupt exception
1	Mod	TLB Modified exception
2	TLBL	TLB Refill exception (load or fetch)
3	TLBS	TLB Refill exception (store)
4	AdEL	Address Error exception (load or fetch)
5	AdES	Address Error exception (store)
6	IBE	Bus Error exception (instruction fetch)
7	DBE	Bus Error exception (data load or store)
8	Sys	System Call exception
9	Bp	Breakpoint exception
10	RI	Reserved Instruction exception
11	CpU	Coprocessor Unusable exception
12	Ov	Integer Overflow exception
13	Tr	Trap exception
14 to 22	—	Reserved for future use
23	WATCH	Watch exception
24 to 31	—	Reserved for future use

The VR4102 has eight interrupt request sources, IP7 to IP0.

For the detailed description of interrupts, refer to Chapter 9.

(1) IP7

This bit indicates whether there is a timer interrupt request.

It is set when the values of Count register and Compare register match.

(2) IP6 to IP2

IP6 to IP2 reflect the state of the interrupt request signal of the CPU core.

(3) IP1 and IP0

These bits are used to set/clear a software interrupt request.

6.3.7 Exception Program Counter (EPC) Register (14)

The Exception Program Counter (EPC) is a read/write register that contains the address at which processing resumes after an exception has been serviced.

The EPC register contains either:

- ✧ Virtual address of the instruction that was the direct cause of the exception
- ✧ Virtual address of the immediately preceding branch or jump instruction (when the instruction associated with the exception is in a branch delay slot, and the BD bit in the Cause register is set to 1).

The EXL bit in the Status register is set to 1 to keep the processor from overwriting the address of the exception-causing instruction contained in the EPC register in the event of another exception.

Figure 6-8 shows the format of the EPC register.

Figure 6-8. EPC Register Format

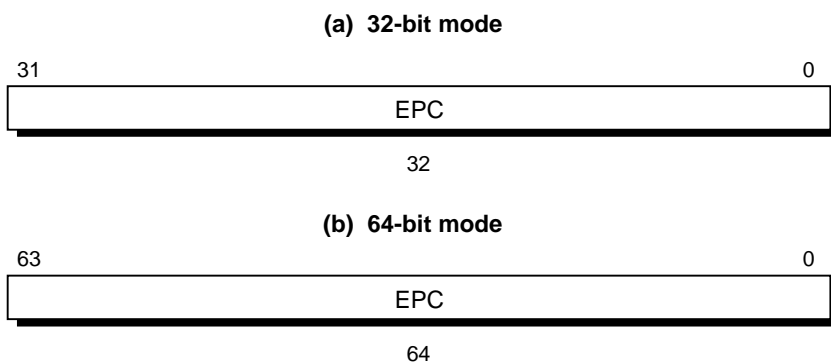

EPC: Restart address after exception processing

6.3.8 WatchLo (18) and WatchHi (19) Registers

The VR4102 processor provides a debugging feature to detect references to a selected physical address; load and store instructions to the location specified by the WatchLo and WatchHi registers cause a Watch exception.

Figures 5-9 and 5-10 show the format of the WatchLo and WatchHi registers.

Figure 5-9. WatchLo and WatchHi Register Format

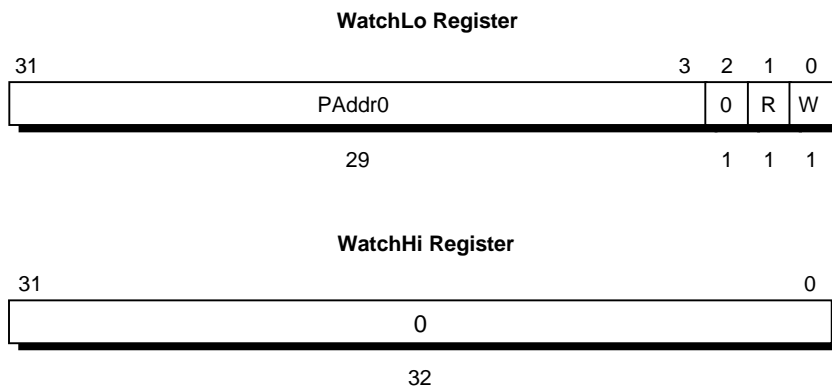

PAddr0 : Specifies physical address bits 31 to 3.

R : If this bit is set to 1, an exception will occur when a load instruction is executed.

W : If this bit is set to 1, an exception will occur when a store instruction is executed.

0 : Reserved for future use. Write 0 in a write operation. When this field is read, 0 is read.

6.3.9 XContext Register (20)

The read/write XContext register contains a pointer to an entry in the page table entry (PTE) array, an operating system data structure that stores virtual-to-physical address translations. If a TLB miss occurs, the operating system loads the untranslated data from the PTE into the TLB to handle the software error.

The XContext register is used by the XTLB Refill exception handler to load TLB entries in 64-bit addressing mode.

The XContext register duplicates some of the information provided in the BadVAddr register, and puts it in a form useful for the XTLB exception handler.

This register is included solely for operating system use. The operating system sets the PTEBase field in the register, as needed. Figure 6-10 shows the format of the XContext register.

Figure 6-10. XContext Register Format

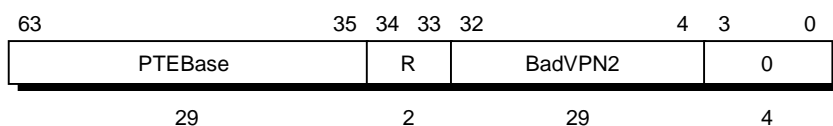

PTEBase : The PTEBase field is a read/write field, and is used by software as the pointer to the base address of the PTE table in the current user address space.

BadVPN2 : The BadVPN2 field is written by hardware if a TLB miss occurs. This field holds the value (VPN2) obtained by halving the virtual page number of the most recent virtual address for which translation failed.

R : Space type (00 → User, 01 → Supervisor, 11 → Kernel). The setting of this field matches virtual address bits 63 and 62.

0 : Reserved for future use. Write 0 in a write operation. When this field is read, 0 is read.

The 29-bit BadVPN2 field has bits 39 to 11 of the virtual address that caused the TLB miss; bit 10 is excluded because a single TLB entry maps to an even-odd page pair. For a 1-Kbyte page size, this format may be used directly to address the pair-table of 8-byte PTEs. For 4-Kbyte-or-more page and PTE sizes, shifting or masking this value produces the appropriate address.

6.3.10 Parity Error Register (26)

The read/write Parity Error (PErr) register contains the cache data parity bits for cache initialization, cache diagnostics, or cache error processing.

The PErr register is loaded by the Index_Load_Tag CACHE instruction. All bits of the parity field are valid on the data cache operation because data cache employs byte parity (1-bit parity for 1 byte). But a LSB of the parity field is valid on the instruction cache operation because instruction cache employs word parity (1-bit parity for 1 word).

The contents of the PErr register are:

- ✧ written into the on-chip data cache on store instructions (instead of the computed parity) when the CE bit of the Status register is set to 1
- ✧ substituted for the computed parity for the CACHE Fill instruction

www.DataSheet4U.com

In the VR4102, parity check is performed only for cache memory.

It is not performed for main memory or peripheral units.

Figure 6-11 shows the format of the PErr register.

Figure 6-11. Parity Error Register Format

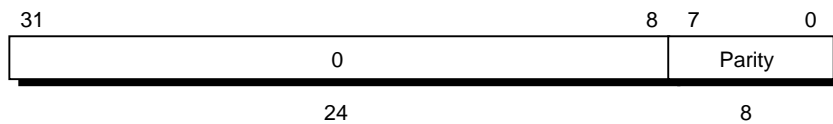

Parity : Specifies the 8-bit parity data to be read from or written to the on-chip cache.

0 : Reserved for future use. Write 0 in a write operation. When this field is read, 0 is read.

6.3.11 Cache Error Register (27)

The 32-bit read/write Cache Error (CacheErr) register processes parity errors in the on-chip cache. Parity errors cannot be corrected by on-chip hardware.

The CacheErr register holds cache index and status bits that indicate the cause of the error.

In the VR4102, parity check is performed only for cache memory.

It is not performed for main memory or peripheral units.

Figure 6-12 shows the format of the CacheErr register.

Figure 6-12. CacheErr Register Format

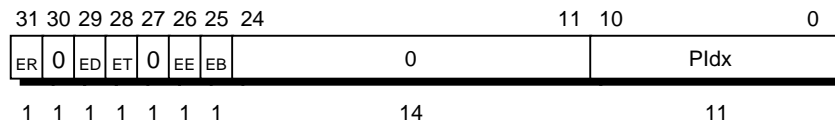

ER : Reference type (0 → Instruction, 1 → Data)

ED : Indicates whether an error occurred in the data field (0 → Normal, 1 → Error).

ET : Indicates whether an error occurred in the tag field (0 → Normal, 1 → Error).

EE : This bit is set if an error occurs on the SysAD bus.

EB : This bit is set if a data error occurs subsequent to an instruction error. (The error status is indicated by the remaining bit positions.) In this case, the data cache must be flushed upon the completion of instruction error processing.

PIdx: Cache index

0 : Reserved for future use. Write 0 in a write operation. When this field is read, 0 is read.

6.3.12 ErrorEPC Register (30)

The Error Exception Program Counter (ErrorEPC) register is similar to the EPC register. It is used to store the Program Counter value at which the Cache Error, Cold Reset, Soft Reset, or NMI exception has been serviced.

The read/write ErrorEPC register contains the virtual address at which instruction processing can resume after servicing an error. This address can be:

- ◇ the virtual address of the instruction that caused the error exception
- ◇ the virtual address of the immediately preceding branch or jump instruction, when the instruction associated with the error exception is in a branch delay slot.

The contents of the ErrorEPC register do not change when the ERL bit of the Status register is set to 1. This prevents the processor when other exceptions occur from overwriting the address of the instruction in this register which causes an error exception.

There is no branch delay slot indication for the ErrorEPC register.

Figure 6-13 shows the format of the ErrorEPC register.

Figure 6-13. The ErrorEPC Register Format

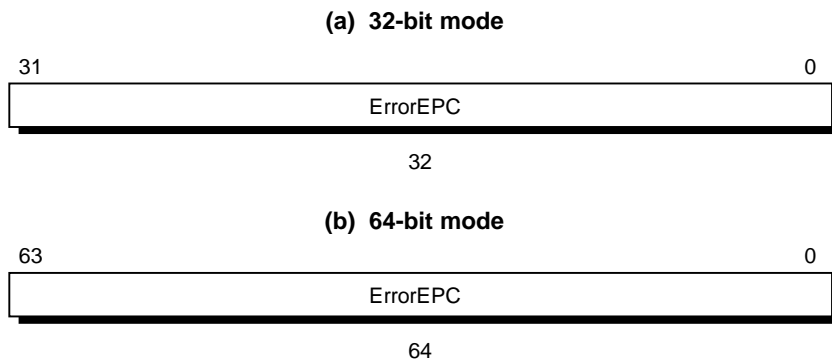

ErrorEPC: Restart address after parity error exception processing. Also indicates the value of the program counter when Cold reset, Soft reset, or NMI exceptions occurred.

6.4 DETAILS OF EXCEPTIONS

This section describes causes, processes, and services of the V_R4102's exceptions.

6.4.1 Exception Types

This section gives sample exception handler operations for the following exception types:

- ◇ Cold Reset
- ◇ Soft Reset
- ◇ NMI
- ◇ Cache error
- ◇ Remaining processor exceptions

When the EXL and ERL bits in the Status register are 0, either User, Supervisor, or Kernel operating mode is specified by the KSU bits in the Status register. When either the EXL or ERL bit is set to 1, the processor is in Kernel mode.

When the processor takes an exception, the EXL bit is set to 1, meaning the system is in Kernel mode. After saving the appropriate state, the exception handler typically resets the EXL bit back to 0. The exception handler sets the EXL bit to 1 so that the saved state is not lost upon the occurrence of another exception while the saved state is being restored.

Returning from an exception also resets the EXL bit to 0. For details, see Chapter 27.

6.4.2 Exception Vector Locations

The Cold Reset, Soft Reset, and NMI exceptions are always branched to the following reset exception vector address (virtual). This address is in an uncached, unmapped space.

- ◇ 0xBFC0 0000 in 32-bit mode
- ◇ 0xFFFF FFFF BFC0 0000 in 64-bit mode

Addresses for the remaining exceptions are a combination of a vector offset and a base address. 64-/32-bit mode exception vectors and their offsets are shown below.

Table 6-3. 64-Bit Mode Exception Vector Base Addresses

	Vector base address (virtual)	Vector offset
Cold Reset Soft Reset NMI	0xFFFF FFFF BFC0 0000 (BEV is automatically set to 1)	0x0000
Cache Error	0xFFFF FFFF A000 0000 (BEV = 0) 0xFFFF FFFF BFC0 0200 (BEV = 1)	0x0100
TLB Refill (EXL = 0)	0xFFFF FFFF 8000 0000 (BEV = 0) 0xFFFF FFFF BFC0 0200 (BEV = 1)	0x0000
XTLB Refill (EXL = 1)		0x0080
Other exceptions		0x0180

Table 6-4. 32-Bit Mode Exception Vector Base Addresses

	Vector base address (virtual)	Vector offset
Cold Reset Soft Reset NMI	0xBFC0 0000 (BEV is automatically set to 1)	0x0000
Cache Error	0xA000 0000 (BEV = 0) 0xBFC0 0200 (BEV = 1)	0x0100
TLB Refill (EXL = 0)	0x8000 0000 (BEV = 0) 0xBFC0 0200 (BEV = 1)	0x0000
XTLB Refill (EXL = 1)		0x0080
Other exceptions		0x0180

Examples 1. TLB Refill Exception Vector

When BEV bit = 0, the vector base address (virtual) for the TLB Refill exception is in kseg0 (unmapped) space.

- ✧ 0x8000 0000 in 32-bit mode
- ✧ 0xFFFF FFFF 8000 0000 in 64-bit mode

When BEV bit = 1, the vector base address (virtual) for the TLB Refill exception is in kseg1 (uncached, unmapped) space.

- ✧ 0xBFC0 0200 in 32-bit mode
- ✧ 0xFFFF FFFF BFC0 0200 in 64-bit mode

This is an uncached, non-TLB-mapped space, allowing the exception handler to bypass the cache and TLB.

Example 2. Cache Error Exception Vector

When BEV bit = 0, the vector base address (virtual) for the Cache Error exception is in kseg1 (uncached, unmapped) space.

- ✧ 0xA000 0000 in 32-bit mode
- ✧ 0xFFFF FFFF A000 0000 in 64-bit mode

When BEV bit = 1, the vector base address (virtual) for the Cache Error exception is in kseg1 (uncached, unmapped) space.

- ✧ 0xBFC0 0200 in 32-bit mode
- ✧ 0xFFFF FFFF BFC0 0200 in 64-bit mode

This is an uncached, non-TLB-mapped space, allowing the exception handler to bypass the cache and TLB.

6.4.3 Priority of Exceptions

While more than one exception can occur for a single instruction, only the exception with the highest priority is reported. Table 6-5 lists the priorities.

Table 6-5. Exception Priority Order

Priority	Exceptions
High	Cold Reset
↑	Soft Reset
	NMI
	Address Error (instruction fetch)
	TLB/XTLB Refill (instruction fetch)
	TLB Invalid (instruction fetch)
	Cache Error (instruction fetch)
	Bus Error (instruction fetch)
	System Call
	Breakpoint
	Coprocessor Unusable
	Reserved Instruction
	Trap
	Integer Overflow
	Address Error (data access)
	TLB/XTLB Refill (data access)
	TLB Invalid (data access)
	TLB Modified (data write)
	Cache Error (data access)
	Watch
↓	Bus Error (data access)
Low	Interrupt (other than NMI)

Hereafter, handling exceptions by hardware is referred to as “process”, and handling exception by software is referred to as “service”.

6.4.4 Cold Reset Exception

Cause

The Cold Reset exception occurs when the ColdReset# signal (internal) is asserted and then deasserted. This exception is not maskable. The Reset# signal (internal) must be asserted along with the ColdReset# signal (for details, see Chapter 7).

Processing

The CPU provides a special interrupt vector for this exception:

0xBFC0 0000 (virtual) in 32-bit mode
0xFFFF FFFF BFC0 0000 (virtual) in 64-bit mode

The Cold Reset vector resides in unmapped and uncached CPU address space, so the hardware need not initialize the TLB or the cache to process this exception. It also means the processor can fetch and execute instructions while the caches and virtual memory are in an undefined state.

The contents of all registers in the CPU are undefined when this exception occurs, except for the following register fields:

When ERL bit of the Status register is 0, the program counter's value at the exception occurrence is saved to the EPC register.

TS and SR of the Status register are cleared to 0.

ERL and BEV of the Status register are set to 1.

The Random register is initialized to the value of its upper bound (31) (refer to **5.4.2 Random Register (1)**).

The Wired register is initialized to 0.

Bits 31 to 28 of the Config register are set to 0, and bits 22 to 3 to 0x04800.

All other bits are undefined.

Servicing

The Cold Reset exception is serviced by:

Initializing all processor registers, coprocessor registers, TLB, caches, and the memory system

Performing diagnostic tests

Bootstrapping the operating system

6.4.5 Soft Reset Exception

Cause

A Soft Reset (sometimes called Warm Reset) occurs when the ColdReset# signal remains deasserted while the Reset# signal goes from assertion to deassertion (for details, see Chapter 7).

A Soft Reset immediately resets all state machines, and sets the SR bit of the Status register. Execution begins at the reset vector when the reset is deasserted. This exception is not maskable.

Caution In the Vr4102, a soft reset never occurs.

www.DataSheet4U.com

Processing

The CPU provides a special interrupt vector for this exception (same location as Cold Reset):

- ◇ 0xBFC0 0000 (virtual) in 32-bit mode
- ◇ 0xFFFF FFFF BFC0 0000 (virtual) in 64-bit mode

This vector is located within unmapped and uncached address space, so that the cache and TLB need not be initialized to process this exception. The SR bit of the Status register is set to 1 to distinguish this exception from a Cold Reset exception.

When this exception occurs, the contents of all registers are preserved except for the following registers:

- ◇ When ERL bit of the Status register is 0, the program counter's value at the exception occurrence is saved to the EPC register.
- ◇ TS bit of the Status register is cleared to 0.
- ◇ ERL, SR, and BEV bits of the Status register are set to 1.

During a soft reset, access to the operating cache or system interface is aborted. This means that the contents of the cache and memory will be undefined if a Soft Reset occurs.

Servicing

The Soft Reset exception is serviced by:

- ◇ Preserving the current processor states for diagnostic tests
- ◇ Reinitializing the system in the same way as for a Cold Reset exception

6.4.6 NMI Exception

Cause

The Nonmaskable Interrupt (NMI) exception occurs in response to the input of the NMI signal (internal). This interrupt is not maskable; it occurs regardless of the settings of the EXL, ERL, and the IE bits in the Status register (for details, see Chapters 9 and 14).

Processing

The CPU provides a special interrupt vector for this exception:

- ◇ 0xBFC0 0000 (virtual) in 32-bit mode
- ◇ 0xFFFF FFFF BFC0 0000 (virtual) in 64-bit mode

This vector is located within unmapped and uncached address space so that the cache and TLB need not be initialized to process an NMI interrupt. The SR bit of the Status register is set to 1 to distinguish this exception from a Cold Reset exception.

Unlike Cold Reset and Soft Reset, but like other exceptions, NMI is taken only at instruction boundaries. The states of the caches and memory system are preserved by this exception.

When this exception occurs, the contents of all registers are preserved except for the following registers:

- ◇ When ERL bit of the Status register is 0, the program counter's value at the exception occurrence is saved to the EPC register.
- ◇ The TS bit of the Status register is cleared to 0.
- ◇ The ERL, SR, and BEV bits of the Status register are set to 1.

Servicing

The NMI exception is serviced by:

- ◇ Preserving the current processor states for diagnostic tests
- ◇ Reinitializing the system in the same way as for a Cold Reset exception

6.4.7 Address Error Exception

Cause

The Address Error exception occurs when an attempt is made to execute one of the following. This exception is not maskable.

Execution of the LW, LWU, SW, or CACHE instruction for word data that is not located on a word boundary

Execution of the LH, LHU, or SH instruction for half-word data that is not located on a half-word boundary

Execution of the LD or SD instruction for double-word data that is not located on a double-word boundary

Referencing the kernel address space in User or Supervisor mode

Referencing the supervisor space in User mode

Referencing an address that does not exist in the kernel, user, or supervisor address space in 64-bit Kernel, User, or Supervisor mode

Branching to an address that is not located on a word boundary

Processing

The common exception vector is used for this exception. The AdEL or AdES code in the Cause register is set. If this exception has been caused by an instruction reference or load operation, AdEL is set. If it has been caused by a store operation, AdES is set.

When this exception occurs, the BadVAddr register stores the virtual address that was not properly aligned or was referenced in protected address space. The contents of the VPN field of the Context and EntryHi registers are undefined, as are the contents of the EntryLo register.

The EPC register contains the address of the instruction that caused the exception, unless this instruction is in a branch delay slot. If it is in a branch delay slot, the EPC register contains the address of the preceding branch instruction and the BD bit of the Cause register is set to 1.

Servicing

The kernel reports the UNIX™ SIGSEGV (segmentation violation) signal to the current process, and this exception is usually fatal.

6.4.8 TLB Exceptions

Three types of TLB exceptions can occur:

TLB Refill exception occurs when there is no TLB entry that matches a referenced address.

A TLB Invalid exception occurs when a TLB entry that matches a referenced virtual address is marked as being invalid (with the V bit set to 0).

The TLB Modified exception occurs when a TLB entry that matches a virtual address referenced by the store instruction is marked as being valid (with the V bit set to 1).

The following three sections describe these TLB exceptions.

www.DataSheet4U.com

(1) TLB Refill Exception (32-bit Space Mode)/XTLB Refill Exception (64-bit Space Mode)

Cause

The TLB Refill exception occurs when there is no TLB entry to match a reference to a mapped address space. This exception is not maskable.

Processing

There are two special exception vectors for this exception; one for references to 32-bit address spaces, and one for references to 64-bit address spaces. The UX, SX, and KX bits of the Status register determine whether the user, supervisor or kernel address spaces referenced are 32-bit or 64-bit spaces. When the EXL bit of the Status register is set to 0, either of these two special vectors is referenced. When the EXL bit is set to 1, the common exception vector is referenced.

This exception sets the TLBL or TLBS code in the ExcCode field of the Cause register. If this exception has been caused by an instruction reference or load operation, TLBL is set. If it has been caused by a store operation, TLBS is set.

When this exception occurs, the BadVAddr, Context, XContext and EntryHi registers hold the virtual address that failed address translation. The EntryHi register also contains the ASID from which the translation fault occurred. The Random register normally contains a valid location in which to place the replacement TLB entry. The contents of the EntryLo register are undefined.

The EPC register contains the address of the instruction that caused the exception, unless this instruction is in a branch delay slot, in which case the EPC register contains the address of the preceding branch instruction and the BD bit of the Cause register is set to 1.

Servicing

To service this exception, the contents of the Context or XContext register are used as a virtual address to fetch memory words containing the physical page frame and access control bits for a pair of TLB entries. The memory word is written into the TLB entry by using the EntryLo0, EntryLo1, or EntryHi register.

It is possible that the physical page frame and access control bits are placed in a page where the virtual address is not resident in the TLB. This condition is processed by allowing a TLB Refill exception in the TLB Refill exception handler. In this case, the common exception vector is used because the EXL bit of the Status register is set to 1.

(2) TLB Invalid Exception

Cause

The TLB Invalid exception occurs when the TLB entry that matches with the virtual address to be referenced is invalid (the V bit is set to 0). This exception is not maskable.

Processing

The common exception vector is used for this exception. The TLBL or TLBS code in the ExcCode field of the Cause register is set. If this exception has been caused by an instruction reference or load operation, TLBL is set. If it has been caused by a store operation, TLBS is set.

When this exception occurs, the BadVAddr, Context, Xcontext, and EntryHi registers contain the virtual address that failed address translation. The EntryHi register also contains the ASID from which the translation fault occurred. The Random register normally stores a valid location in which to place the replacement TLB entry. The contents of the EntryLo register are undefined.

The EPC register contains the address of the instruction that caused the exception unless this instruction is in a branch delay slot, in which case the EPC register contains the address of the preceding branch instruction and the BD bit of the Cause register is set to 1.

Servicing

Usually, the V bit of a TLB entry is cleared in the following cases:

- When a virtual address does not exist
- When the virtual address exists, but is not in main memory (a page fault)
- When a trap is required on any reference to the page (for example, to maintain a reference bit)

After servicing the cause of a TLB Invalid exception, the TLB entry is located with a TLBP (TLB Probe) instruction, and replaced by an entry with its Valid bit set to 1.

(3) TLB Modified Exception**Cause**

The TLB Modified exception occurs when the TLB entry that matches with the virtual address referenced by the store instruction is valid (bit V is 1) but is not writable (bit D is 0). This exception is not maskable.

Processing

The common exception vector is used for this exception, and the Mod code in the ExcCode field of the Cause register is set.

When this exception occurs, the BadVAddr, Context, Xcontext, and EntryHi registers contain the virtual address that failed address translation. The EntryHi register also contains the ASID from which the translation fault occurred. The contents of the EntryLo register are undefined.

The EPC register contains the address of the instruction that caused the exception unless that instruction is in a branch delay slot, in which case the EPC register contains the address of the preceding branch instruction and the BD bit of the Cause register is set to 1.

Servicing

The kernel uses the failed virtual address or virtual page number to identify the corresponding access control bits. The page identified may or may not permit write accesses; if writes are not permitted, a write protection violation occurs.

If write accesses are permitted, the page frame is marked dirty (/writable) by the kernel in its own data structures. The TLBP instruction places the index of the TLB entry that must be altered into the Index register. The word data containing the physical page frame and access control bits (with the D bit set to 1) is loaded to the EntryLo register, and the contents of the EntryHi and EntryLo registers are written into the TLB.

6.4.9 Cache Error Exception

Cause

The Cache Error exception occurs when a cache parity error is detected. This exception is not maskable, but error detection can be disabled by setting the DE bit of the Status register.

If a parity error is detected when the DE bit of Status register is not set, a cache error exception is taken during one of the following operations:

- An instruction fetch from instruction cache

- A load from the data cache

- Tag parity check on a store

- Main memory read by the processor

- Most of the CACHE instructions (no exception is taken for the Index_Load_Tag and Index_Store_Tag CACHE instructions)

In the VR4102, the parity error from the external bus and on-chip peripheral buses is not checked.

Processing

The processor sets the ERL bit in the Status register, saves the address to recover from the exception to the ErrorEPC register, and then transfers to a special vector in uncached space.

If the BEV bit = 0, the vector is one of the following:

- ✧ 0xA000 0100 (virtual) in 32-bit mode

- ✧ 0xFFFF FFFF A000 0100 (virtual) in 64-bit mode

If the BEV bit = 1, the vector is one of the following:

- ✧ 0xBFC0 0300 (virtual) in 32-bit mode

- ✧ 0xFFFF FFFF BFC0 0300 (virtual) in 64-bit mode

Servicing

All errors should be logged. To correct cache parity errors, the system uses the CACHE instruction to invalidate the cache block, overwrites the old data through a cache miss, and resumes execution with an ERET instruction. Other errors are not correctable and are likely to be fatal to the current process.

6.4.10 Bus Error Exception

Cause

A Bus Error exception is raised by board-level circuitry for events such as bus time-out, local bus parity errors, and invalid physical memory addresses or access types. This exception is not maskable.

A Bus Error exception occurs only when a cache miss refill, uncached reference, or unbuffered write occurs synchronously. In other words, it occurs when an illegal access is detected during BCU read.

For details of illegal accesses, refer to **10.4.6 Illegal Access Notification**.

Processing

The common interrupt vector is used for a Bus Error exception. The IBE or DBE code in the ExcCode field of the Cause register is set, signifying whether the instruction caused the exception by an instruction reference, load operation, or store operation.

The EPC register contains the address of the instruction that caused the exception, unless it is in a branch delay slot, in which case the EPC register contains the address of the preceding branch instruction and the BD bit of the Cause register is set to 1.

Servicing

The physical address at which the fault occurred can be computed from information available in the System Control Coprocessor (CP0) registers.

If the IBE code in the Cause register is set (indicating an instruction fetch), the virtual address is contained in the EPC register (or 4 + the contents of the EPC register if the BD bit of the Cause register is set to 1).

If the DBE code is set (indicating a load or store), the virtual address of the instruction that caused the exception (the address of the preceding branch instruction if the BD bit of the Cause register is set to 1) is saved to the EPC register (or 4 + the contents of the EPC register if the BD bit of the Cause register is set to 1).

The virtual address of the load and store instruction can then be obtained by interpreting the instruction. The physical address can be obtained by using the TLBP instruction and reading the EntryLo register to compute the physical page number.

At the time of this exception, the kernel reports the UNIX SIGBUS (bus error) signal to the current process, but the exception is usually fatal.

6.4.11 System Call Exception

Cause

A System Call exception occurs during an attempt to execute the SYSCALL instruction. This exception is not maskable.

Processing

The common exception vector is used for this exception, and the Sys code in the ExcCode field of the Cause register is set.

The EPC register contains the address of the SYSCALL instruction unless it is in a branch delay slot, in which case the EPC register contains the address of the preceding branch instruction.

If the SYSCALL instruction is in a branch delay slot, the BD bit of the Status register is set to 1; otherwise this bit is cleared.

Servicing

When this exception occurs, control is transferred to the applicable system routine.

To resume execution, the EPC register must be altered so that the SYSCALL instruction does not re-execute; this is accomplished by adding a value of 4 to the EPC register before returning.

If a SYSCALL instruction is in a branch delay slot, interpretation of the branch instruction is required to resume execution.

6.4.12 Breakpoint Exception

Cause

A Breakpoint exception occurs when an attempt is made to execute the BREAK instruction. This exception is not maskable.

Processing

The common exception vector is used for this exception, and the BP code in the ExcCode field of the Cause register is set.

The EPC register contains the address of the BREAK instruction unless it is in a branch delay slot, in which case the EPC register contains the address of the preceding branch instruction.

If the BREAK instruction is in a branch delay slot, the BD bit of the Status register is set to 1; otherwise this bit is cleared.

Servicing

When the Breakpoint exception occurs, control is transferred to the applicable system routine. Additional distinctions can be made by analyzing the unused bits of the BREAK instruction (bits 25 to 6), and loading the contents of the instruction whose address the EPC register contains. A value of 4 must be added to the contents of the EPC register to locate the instruction if it resides in a branch delay slot.

To resume execution, the EPC register must be altered so that the BREAK instruction does not re-execute; this is accomplished by adding a value of 4 to the EPC register before returning.

If a BREAK instruction is in a branch delay slot, interpretation (decoding) of the branch instruction is required to resume execution.

6.4.13 Coprocessor Unusable Exception

Cause

The Coprocessor Unusable exception occurs when an attempt is made to execute a coprocessor instruction for either:

a corresponding coprocessor unit that has not been marked usable (Status register bit, CU[0] = 0), or
CPO instructions, when the unit has not been marked usable (Status register bit, CU[0] = 0) and the process executes in User or Supervisor mode.

This exception is not maskable.

Processing

The common exception vector is used for this exception, and the CPU code in the ExcCode field of the Cause register is set. The CE bit of the Cause register indicates which of the four coprocessors was referenced.

The EPC register contains the address of the coprocessor instruction that causes an exception unless it is in a branch delay slot, in which case the EPC register contains the address of the preceding branch instruction and the BD bit of the Cause register is set to 1.

Servicing

The coprocessor unit to which an attempted reference was made is identified by the CE bit of the Cause register. One of the following processing is performed by the handler:

If the process is entitled access to the coprocessor, the coprocessor is marked usable and the corresponding state is restored to the coprocessor.

If the process is entitled access to the coprocessor, but the coprocessor does not exist or has failed, interpretation of the coprocessor instruction is possible.

If the BD bit in the Cause register is set to 1, the branch instruction must be interpreted; then the coprocessor instruction can be emulated and execution resumed with the EPC register advanced past the coprocessor instruction.

If the process is not entitled access to the coprocessor, the kernel reports UNIX SIGILL/ILL_PRIVIN_FAULT (illegal instruction/privileged instruction fault) signal to the current process, and this exception is fatal.

6.4.14 Reserved Instruction Exception

Cause

The Reserved Instruction exception occurs when an attempt is made to execute one of the following instructions:

- ◇ Instruction with an undefined major opcode (bits 31 to 26)
- ◇ SPECIAL instruction with an undefined minor opcode (bits 5 to 0)
- ◇ REGIMM instruction with an undefined minor opcode (bits 20 to 16)
- ◇ 64-bit instructions in 32-bit User or Supervisor mode

64-bit operations are always valid in Kernel mode regardless of the value of the KX bit in the Status register. This exception is not maskable.

Processing

The common exception vector is used for this exception, and the RI code in the ExcCode field of the Cause register is set.

The EPC register contains the address of the reserved instruction unless it is in a branch delay slot, in which case the EPC register contains the address of the preceding branch instruction and the BD bit of the Cause register is set to 1.

Servicing

All currently defined MIPS ISA instructions can be executed. The process executing at the time of this exception is handled by a UNIX SIGILL/ILL_RESOP_FAULT (illegal instruction/reserved operand fault) signal. This error is usually fatal.

6.4.15 Trap Exception

Cause

The Trap exception occurs when a TGE, TGEU, TLT, TLTU, TEQ, TNE, TGEI, TGEUI, TLTU, TLTUI, TEQI, or TNEI instruction results in a TRUE condition. This exception is not maskable.

Processing

The common exception vector is used for this exception, and the Tr code in the ExcCode field of the Cause register is set.

The EPC register contains the address of the trap instruction causing the exception unless the instruction is in a branch delay slot, in which case the EPC register contains the address of the preceding branch instruction and the BD bit of the Cause register is set to 1.

Servicing

At the time of a Trap exception, the kernel reports the UNIX SIGFPE/FPE_INTOVF_TRAP (floating-point exception/integer overflow) signal to the current process, but the exception is usually fatal.

6.4.16 Integer Overflow Exception

Cause

An Integer Overflow exception occurs when an ADD, ADDI, SUB, DADD, DADDI or DSUB instruction results in a 2's complement overflow. This exception is not maskable.

Processing

The common exception vector is used for this exception, and the Ov code in the ExcCode field of the Cause register is set.

The EPC register contains the address of the instruction that caused the exception unless the instruction is in a branch delay slot, in which case the EPC register contains the address of the preceding branch instruction and the BD bit of the Cause register is set to 1.

Servicing

At the time of the exception, the kernel reports the UNIX SIGFPE/FPE_INTOVF_TRAP (floating-point exception/integer overflow) signal to the current process, and this exception is usually fatal.

6.4.17 Watch Exception

Cause

A Watch exception occurs when a load or store instruction references the physical address specified by the WatchLo/WatchHi registers. The WatchLo/WatchHi registers specify whether a load or store or both could have initiated this exception.

When the R bit of the WatchLo register is set to 1: Load instruction

When the W bit of the WatchLo register is set to 1: Store instruction

When both the R bit and W bit of the WatchLo register are set to 1: Load instruction or store instruction

The CACHE instruction never causes a Watch exception.

The Watch exception is postponed while the EXL bit in the Status register is set to 1, and Watch exception is only maskable by setting the EXL bit in the Status register to 1.

Processing

The common exception vector is used for this exception, and the WATCH code in the ExcCode field of the Cause register is set.

The EPC register contains the address of the load or store instruction that caused the exception unless it is in a branch delay slot, in which case the EPC register contains the address of the preceding branch instruction and the BD bit of the Cause register is set to 1.

Servicing

The Watch exception is a debugging aid; typically the exception handler transfers control to a debugger, allowing the user to examine the situation. To continue, once the Watch exception must be disabled to execute the faulting instruction. The Watch exception must then be reenabled. The faulting instruction can be executed either by the debugger or by setting breakpoints.

6.4.18 Interrupt Exception

Cause

The Interrupt exception occurs when one of the eight interrupt conditions^{Note} is asserted. In the V_R4102, interrupt requests from internal peripheral units first enter the ICU and are then notified to the CPU core via one of four interrupt sources (Int [3:0]) or NMI.

Each of the eight interrupts can be masked by clearing the corresponding bit in the IM field of the Status register, and all of the eight interrupts can be masked at once by clearing the IE bit of the Status register or setting the EXL/ERL bit.

Note: They are 1 timer interrupt, 5 ordinary interrupts, and 2 software interrupts.

Of the five ordinary interrupts, Int4 is never asserted active.

Processing

The common exception vector is used for this exception, and the Int code in the ExcCode field of the Cause register is set.

The IP field of the Cause register indicates current interrupt requests. It is possible that more than one of the bits can be simultaneously set (or cleared) if the interrupt request signal is asserted and then deasserted before this register is read.

The EPC register contains the address of the instruction that caused the exception unless it is in a branch delay slot, in which case the EPC register contains the address of the preceding branch instruction and the BD bit of the Cause register is set to 1.

Servicing

If the interrupt is caused by one of the two software-generated exceptions (SW0 or SW1), the interrupt condition is cleared by setting the corresponding Cause register bit to 0.

If the interrupt is caused by hardware, the interrupt condition is cleared by deactivating the corresponding interrupt request signal.

6.5 EXCEPTION PROCESSING AND SERVICING FLOWCHARTS

The remainder of this chapter contains flowcharts for the following exceptions and guidelines for their handlers:

- ✧ Common exceptions and a guideline to their exception handler
- ✧ TLB/XTLB Refill exception and a guideline to their exception handler
- ✧ Cache Error exception
- ✧ Cold Reset, Soft Reset and NMI exceptions, and a guideline to their handler.

Generally speaking, the exceptions are "processed" by hardware (HW); the exceptions are then "serviced" by software (SW).

Figure 6-14. Common Exception Handler (1/2)

(a) Processing exceptions other than Cold reset, Soft reset, NMI, TLB/XTLB Mismatch, and Cache Error exceptions (hardware)

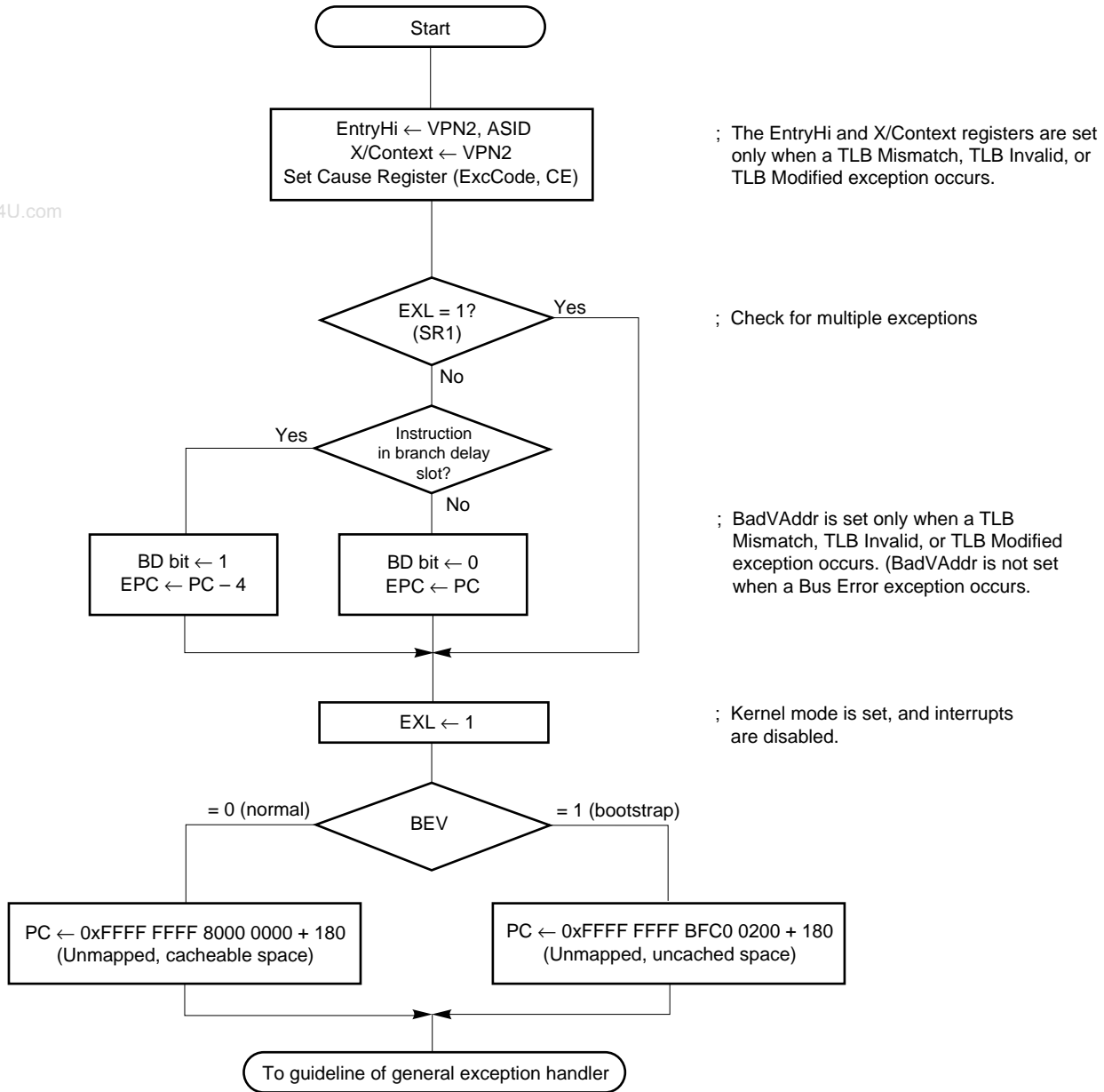

Remark The exceptions can be masked by the IE or IM bit. The Watch exception can be set to pending status by setting the EXL bit.

Figure 6-14. Common Exception Handler (2/2)

(b) Guideline of general exception handler (software)

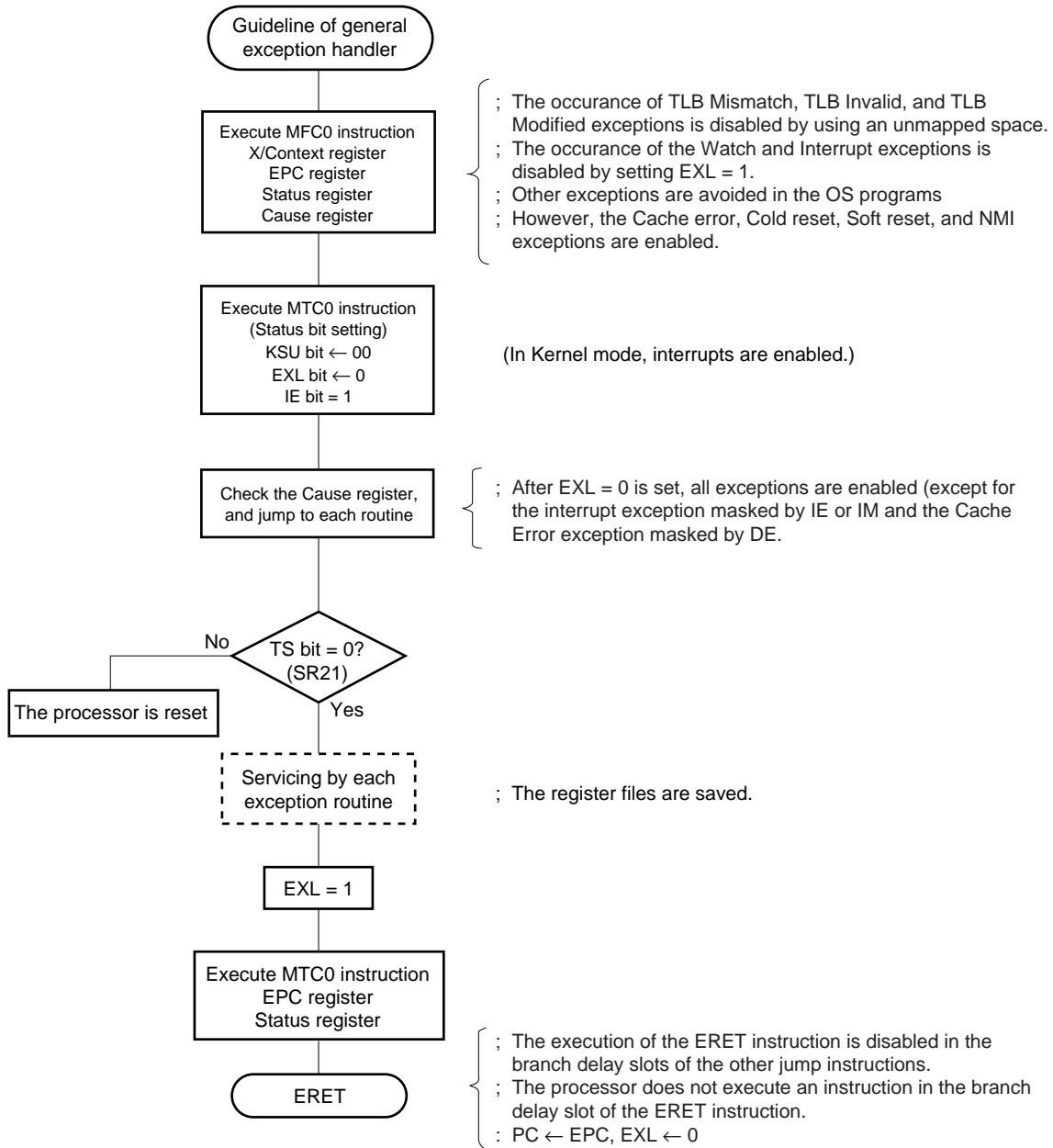

Figure 6-15. TLB/XTLB Refill Exception Handler (1/2)

(a) Hardware



Figure 6-15. TLB/XTLB Refill Exception Handler (2/2)

(b) Guideline of TLB/XTLB exception handler (software)

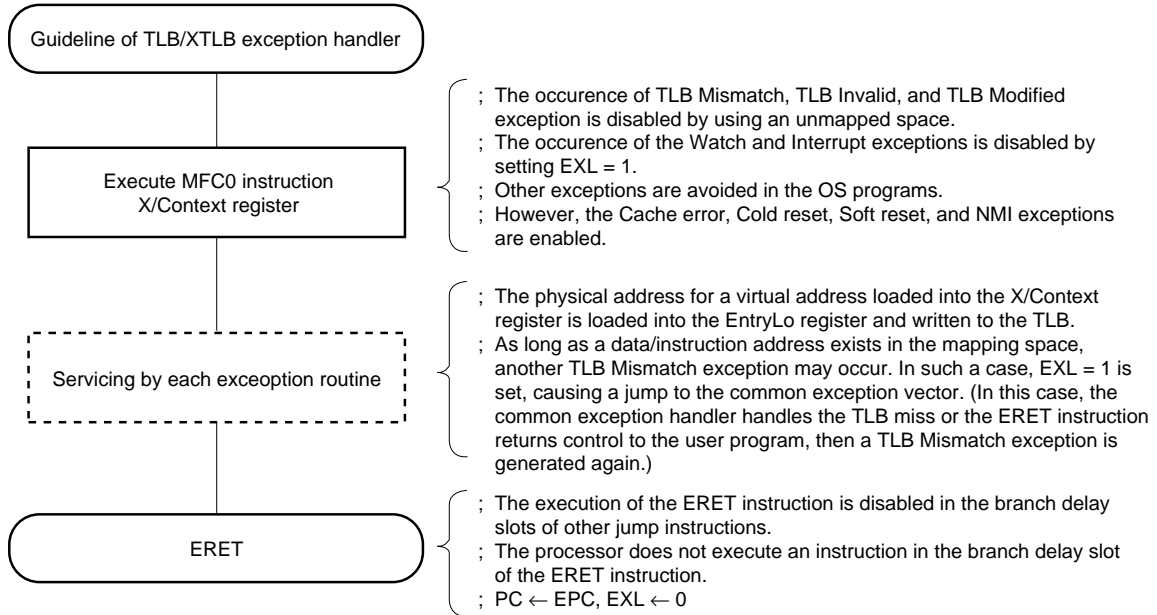

www.DataSheet4U.com

Figure 6-16. Cache Error Exception Handler

Hardware

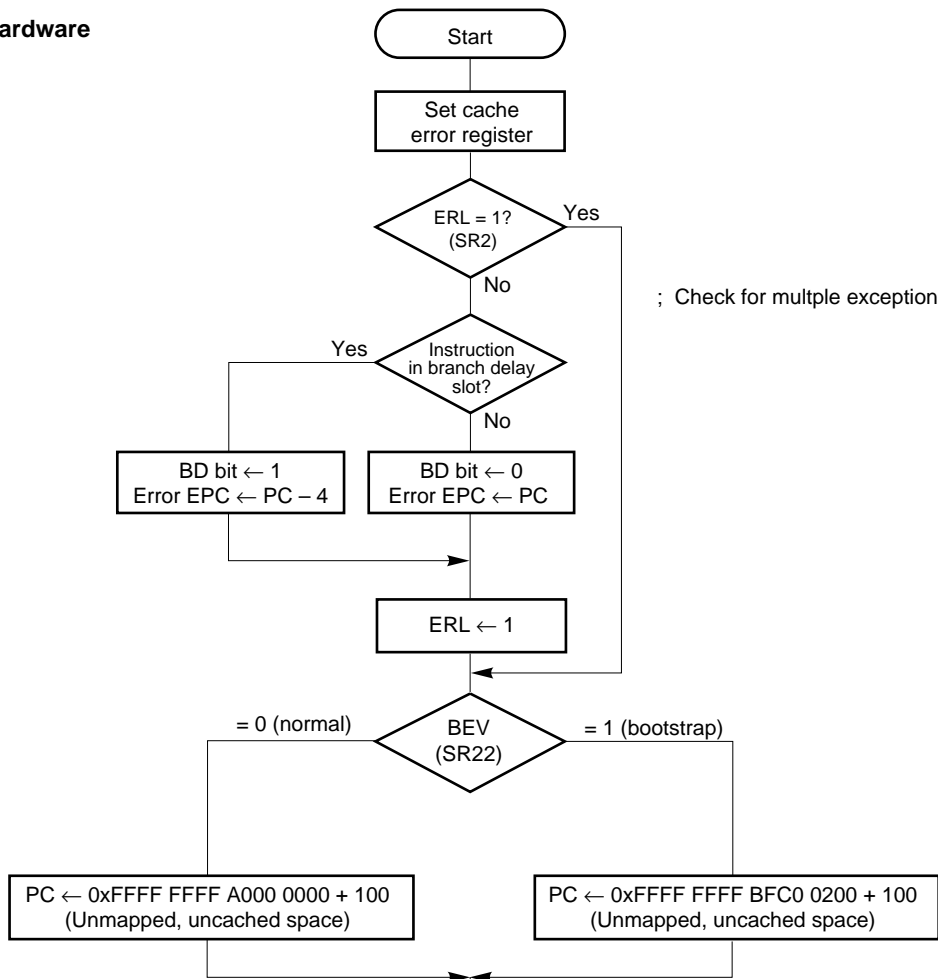

; Check for multiple exceptions

Software

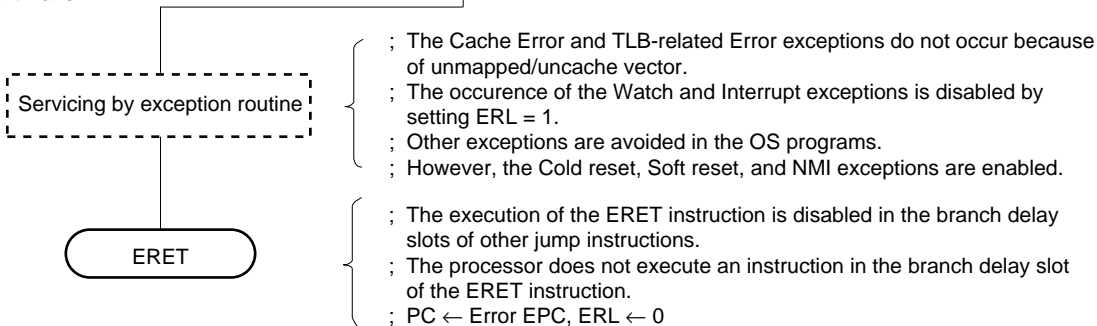

Remark The Cache Error exception can be masked by setting the DE (SR16) bit to 1. When ERL = 1, Cache Error exceptions are masked.

Figure 6-17. Cold Reset, Soft Reset, and NMI Exception Handler

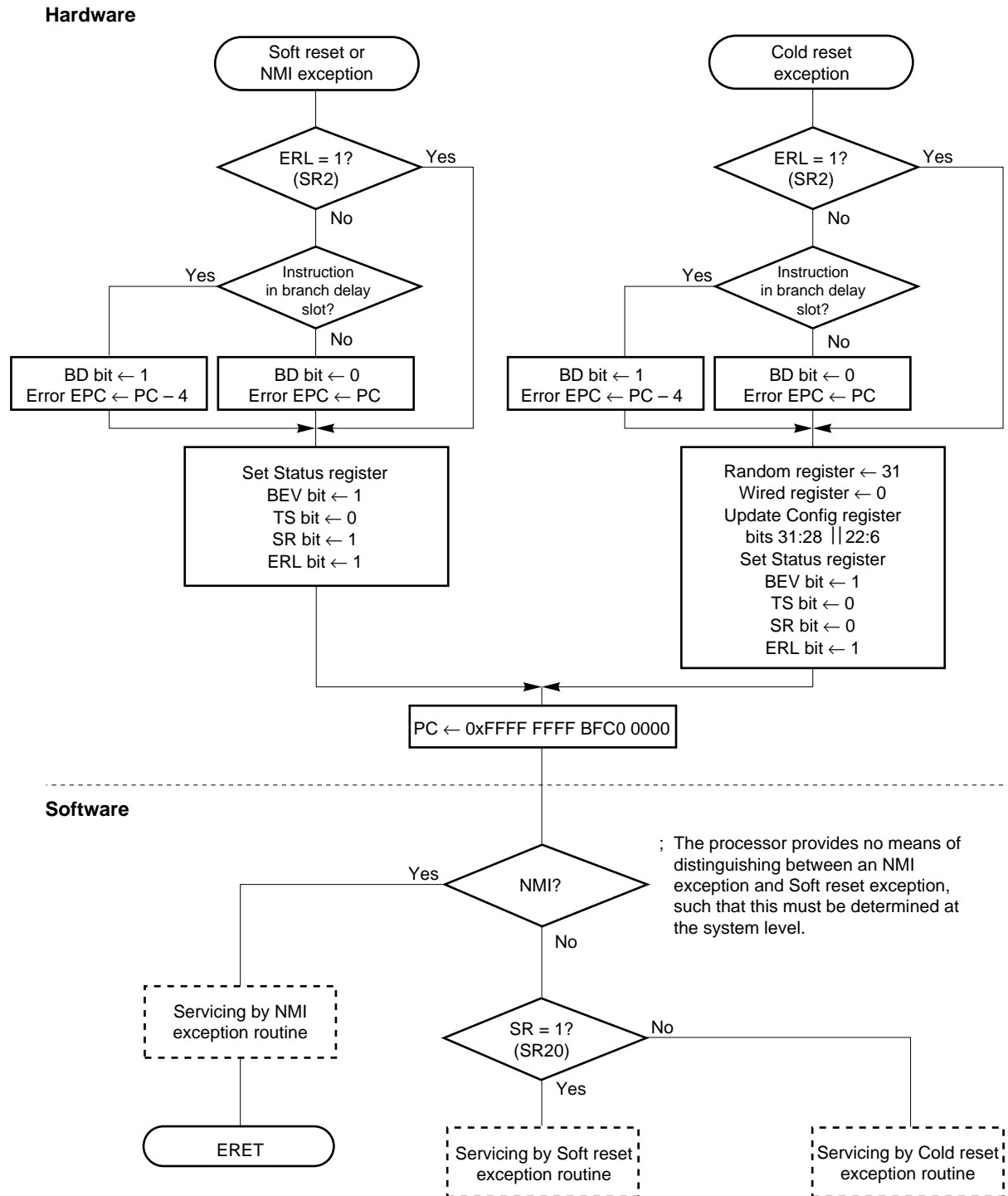

www.DataSheet4U.com

[MEMO]

CHAPTER 7 INITIALIZATION INTERFACE

This chapter describes the initialization interface and processor modes. It also explains the reset signal descriptions and types, signal- and timing-related dependence, and the initialization sequence during each mode that can be selected by the user.

Remark # that follows signal names indicates active low.

7.1 RESET FUNCTION

There are five ways to reset the VR4102. Each is summarized below.

7.1.1 RTC Reset

During power-on, set the RTCRST# pin as active. After waiting (about 600 ms) for the 32.768-kHz oscillator to begin oscillating when the power supply is stable at 3.0 V or above, setting the RTCRST# pin as inactive causes the RTC unit to begin counting. Next, when the POWER pin, DCD# pin, or GPIO[3] pin becomes inactive, the VR4102 asserts the POWERON pin and uses the BATTINH/BATTINT# signal to perform a battery level check. If the battery check's result is OK, the VR4102 asserts the MPOWER pin and waits for the stabilization time period (about 350 ms) for the external agent's DC/DC converter, then begins PLL oscillation and starts all clocks (a period of about 16 ms following the start of PLL oscillation is required for stabilization of PLL oscillation).

An RTC reset does not save any of the status information and it completely initializes the processor's internal state. Since the DRAM is not switched to self refresh mode, the contents of DRAM after an RTC reset are not at all guaranteed.

After a reset, the processor becomes the system bus master and it begins the Cold reset exception sequence to access the reset vectors in the ROM space. Since only part of the internal status is reset when a reset occurs in the VR4102, the processor should be completely initialized by software.

Figure 7-1. RTC Reset

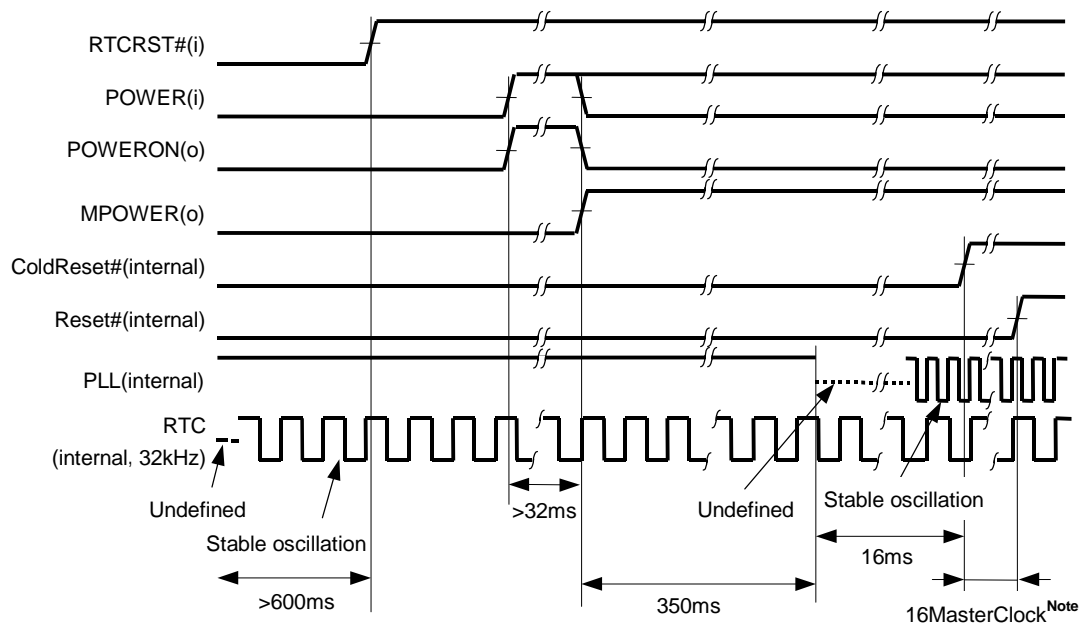

Note MasterClock is the basic clock used in the CPU core.

7.1.2 RSTSW

After the RSTSW# pin becomes active and then becomes inactive 100 μ s later, the VR4102 starts PLL oscillation and starts all clocks (a period of about 16 ms following the start of PLL oscillation is required for stabilization of PLL oscillation).

A reset by RSTSW initializes the entire internal state except for the RTC timer and the PMU. Since the DRAM is not switched to self refresh mode, the contents of DRAM after an RTC reset are not at all guaranteed.

After a reset, the processor becomes the system bus master and it begins the Cold reset exception sequence to access the reset vectors in the ROM space. Since only part of the internal status is reset when a reset occurs in the VR4102, the processor should be completely initialized by software.

Figure 7-2. RSTSW

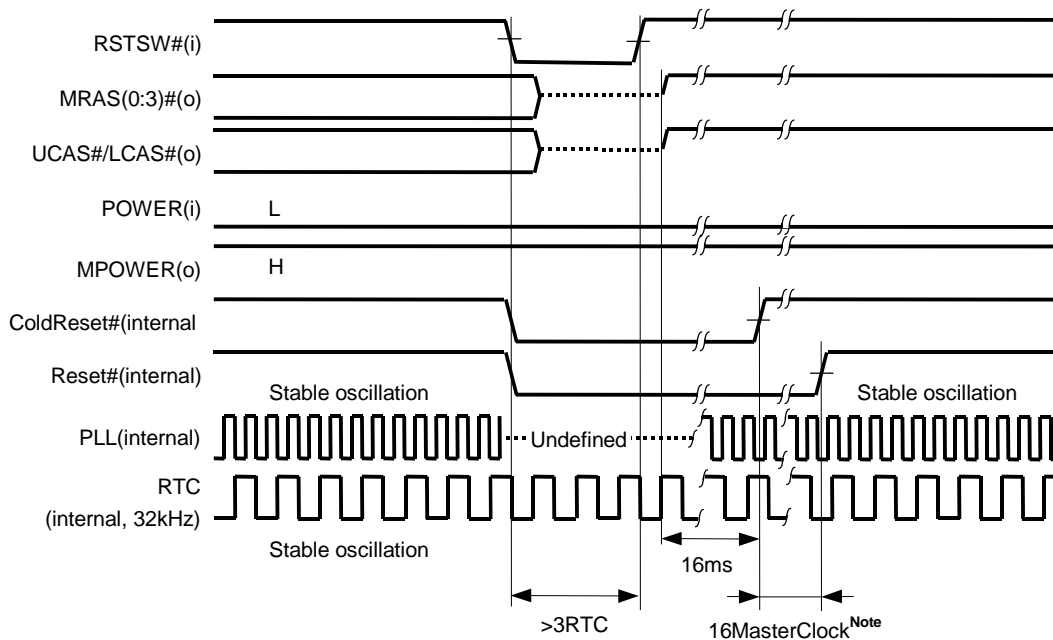

Note MasterClock is the basic clock used in the CPU core.

7.1.3 Deadman's Switch

After the Deadman's switch unit is enabled, if the Deadman's switch is not cleared within the specified time period, the VR4102 is immediately returned to reset status. Setting and clearing of the Deadman's switch is performed by software.

A reset by the Deadman's switch initializes the entire internal state except for the RTC timer and the PMU. Since the DRAM is not switched to self refresh mode, the contents of DRAM after a Deadman's switch reset are not at all guaranteed.

After a reset, the processor becomes the system bus master and it begins the Cold reset exception sequence to access the reset vectors in the ROM space. Since only part of the internal status is reset when a reset occurs in the VR4102, the processor should be completely initialized by software.

www.DataSheet4U.com

Figure 7-3. Deadman's Switch

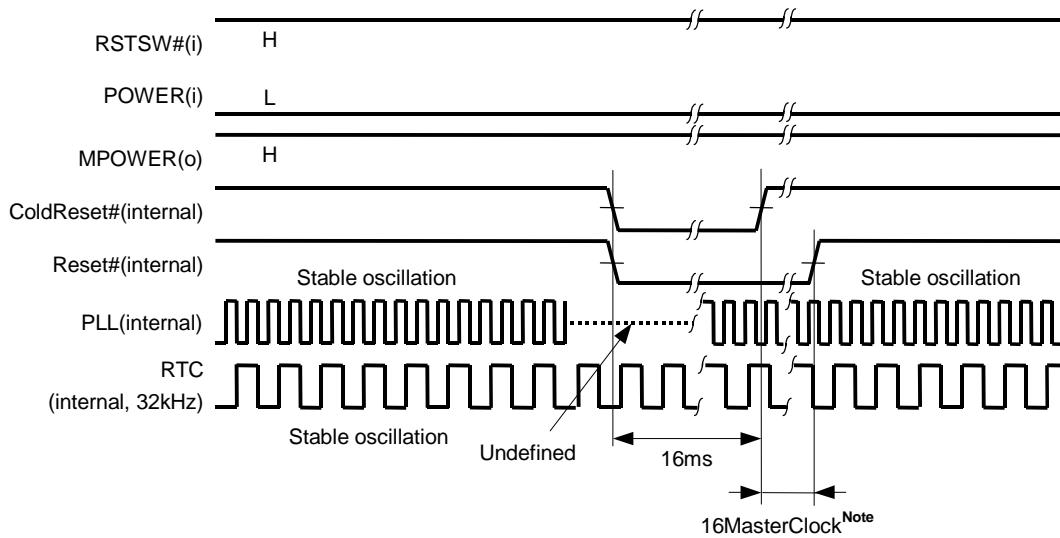

Note MasterClock is the basic clock used in the CPU core.

7.1.4 Software Shutdown

When the software executes the HIBERNATE instruction, the VR4102 sets the DRAM to self refresh mode and sets the MPOWER pin as inactive, then enters reset status. Recovery from reset status occurs when the POWER pin is asserted, when a WakeUpTimer interrupt occurs, or when the DCD# pin is asserted.

A reset by software shutdown initializes the entire internal state except for the RTC timer and the PMU.

After a reset, the processor becomes the system bus master and it begins the Cold reset exception sequence to access the reset vectors in the ROM space. Since only part of the internal status is reset when a reset occurs in the VR4102, the processor should be completely initialized by software.

Figure 7-4. Software Shutdown

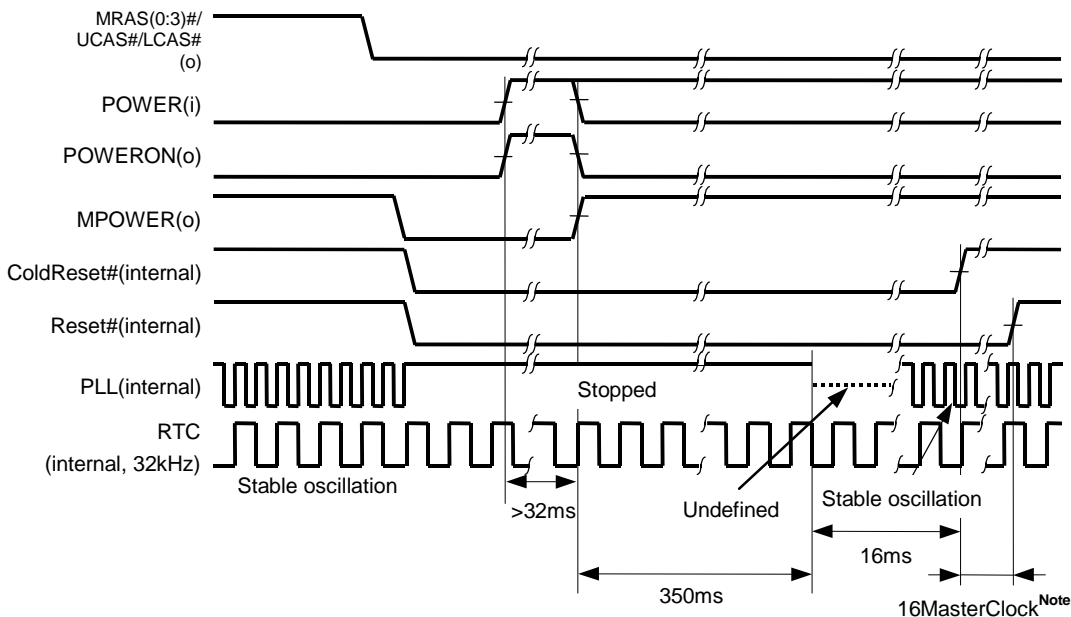

Note MasterClock is the basic clock used in the CPU core.

7.1.5 HALTimer Shutdown

After an RTC reset is canceled, if the HAL timer is not canceled by software within about four seconds (the HALTIMERRST bit of the PMUCNTREG register is not set to 1), the VR4102 enters reset status. Recovery from reset status occurs when the POWER pin is asserted or when a WakeUpTimer interrupt occurs.

A reset by HAL timer initializes the entire internal state except for the RTC timer and the PMU.

After a reset, the processor becomes the system bus master and it begins the Cold reset exception sequence to access the reset vectors in the ROM space. Since only part of the internal status is reset when a reset occurs in the VR4102, the processor should be completely initialized by software.

Figure 7-5. HALTimer Shutdown

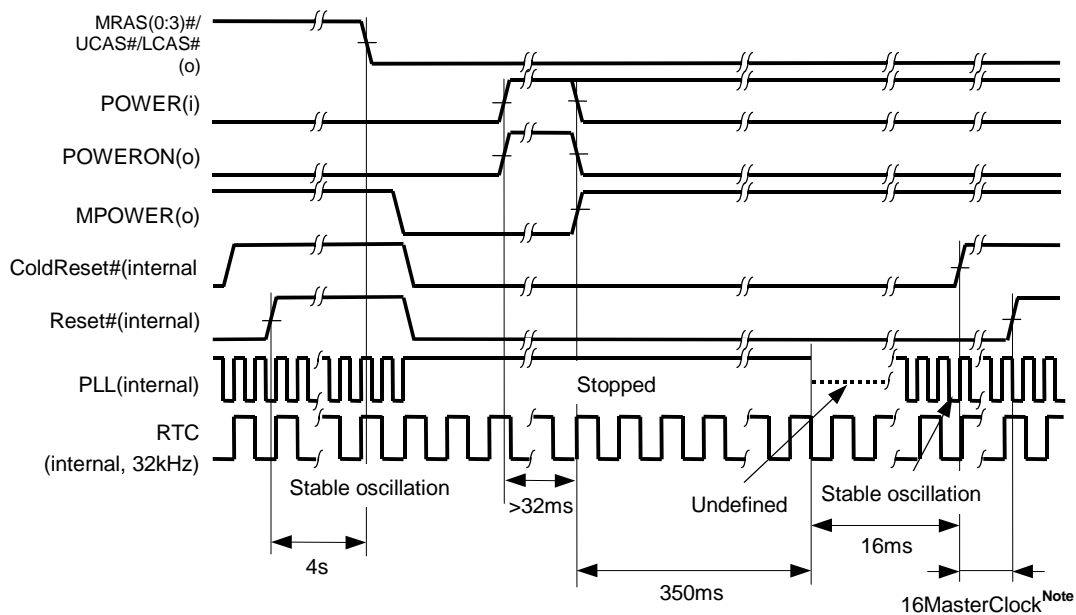

Note MasterClock is the basic clock used in the CPU core.

7.2 POWERON SEQUENCE

The factors that cause the VR4102 to switch from hibernate mode or shutdown mode to full speed mode are called power-on factors. There are four power-on factors: assertion of the POWERON pin, assertion of the DCD# pin, activation of the wakeup timer, and assertion of the GPIO pins (GPIO[3..0], GPIO[12..9]). When an activation factor occurs, the VR4102 asserts the POWERON pin, then provides notification to external agents that the VR4102 is ready for power-on. Three RTC clocks after the POWERON pin is asserted, the VR4102 checks the state of the BATTINH/BATTINT# pin. If the BATTINH/BATTINT# pin's state is low, the POWERON pin is deasserted one RTC clock after the BATTINH/BATTINT# pin check is completed, then the VR4102 is not activated. If the BATTINH/BATTINT# pin's state is high, the POWERON pin is deasserted three RTC clocks after the BATTINH/BATTINT# pin check is completed, then the MPOWER pin is asserted and the VR4102 is activated.

Figure 7-6 shows a timing chart of VR4102 activation and Figure 7-7 shows a timing chart of when activation fails due to the BATTINH/BATTINT# pin's "low" state.

For details of poweron sequence according to each power-on factor, refer to chapter 15.

Figure 7-6. VR4102 Activation Sequence (when Battery Check Is OK)

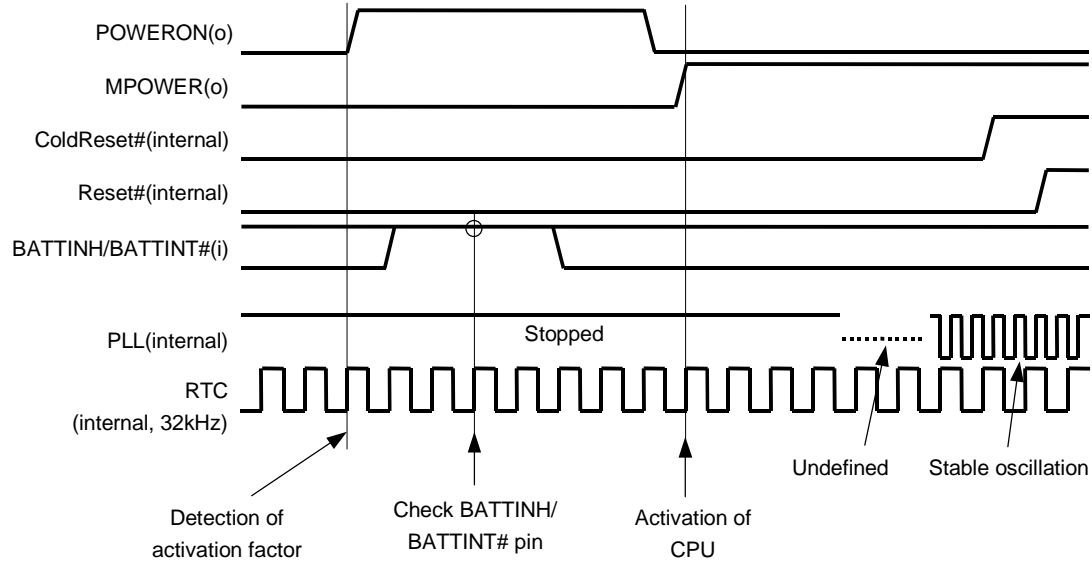
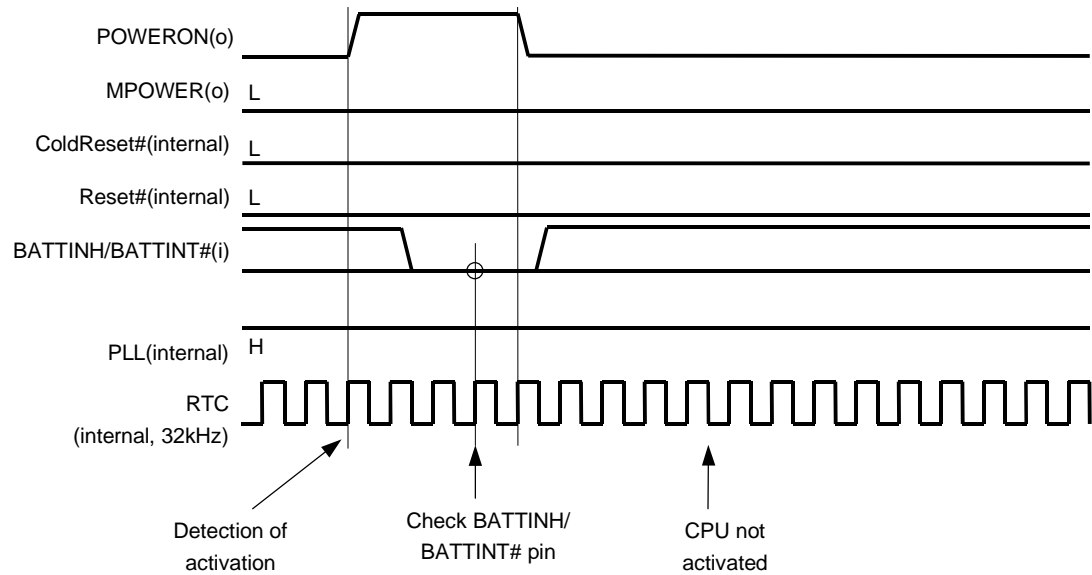

Figure 7-7. VR4102 Activation Sequence (when Battery Check Is NG)



7.3 RESET OF THE CPU CORE

This section describes the reset sequence of the VR4100 CPU core. For details about factors of reset or reset of the whole VR4102, refer to 7.1 and Chapter 15.

7.3.1 Cold Reset

In the VR4102, a cold reset sequence is executed in the CPU core in the following cases:

- RTC reset
- RSTSW reset
- Deadman's SW shutdown
- Software shutdown
- HAL Timer shutdown
- Battery low shutdown
- Battery lock release shutdown

A Cold Reset completely initializes the CPU core, except for the following register bits.

- The TS and SR bits of the Status register are cleared to 0.
- The ERL and BEV bits of the Status register are set to 1.
- The upper limit value (31) is set in the Random register.
- The Wired register is initialized to 0.
- Bits 31 to 28 of the Config register are set to 0 and bits 22 to 3 to 0x04800; the other bits are undefined.
- The values of the other registers are undefined.

Once power to the processor is established, the ColdReset# (internal) and the Reset# (internal) signals are asserted and a Cold Reset is started. After approximately 2 ms assertion, the ColdReset# signal is deasserted synchronously with MasterOut. Then the Reset# signal is deasserted synchronously with MasterOut, and the Cold Reset is completed.

Upon reset, the CPU core becomes bus master and drives the SysAD bus (internal). After Reset# is deasserted, the CPU core branches to the Reset exception vector and begins executing the reset exception code.

7.3.2 Soft Reset

Caution Soft Reset is not supported in the present Vr4102.

A Soft Reset initializes the CPU core without affecting the clocks; in other words, a Soft Reset is a logic reset. In a Soft Reset, the CPU core retains as much state information as possible; all state information except for the following is retained:

- The TS bit of the Status register is cleared to 0.
- The SR, ERL and BEV bits of the Status register are set to 1.
- The Count register is initialized to 0.
- The IP7 bit of the Cause register is cleared to 0.
- Any Interrupts generated on the SysAD bus are cleared.
- NMI is cleared.
- The Config register is initialized.

A Soft Reset is started by assertion of the Reset# signal, and is completed at the deassertion of the Reset# signal synchronized with MasterOut. In general, data in the CPU core is preserved for debugging purpose.

Upon reset, the CPU core becomes bus master and drives the SysAD bus (internal). After Reset# is deasserted, the CPU core branches to the Reset exception vector and begins executing the reset exception code.

Figure 7-8. Cold Reset

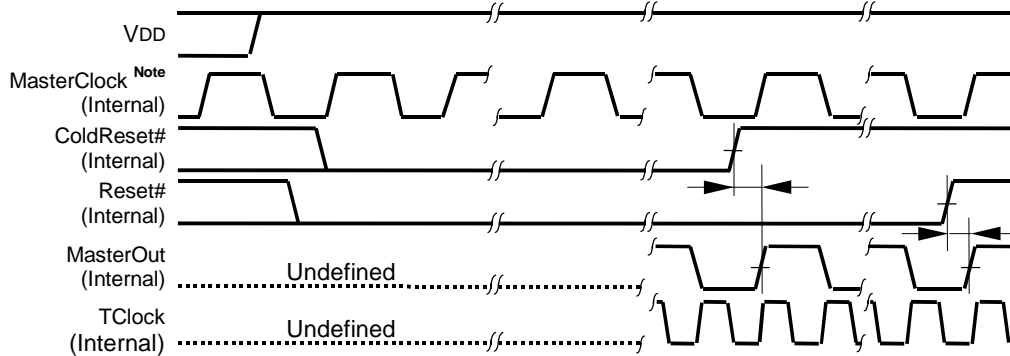

Note MasterClock is the basic clock used in the CPU core.

Figure 7-9. Soft Reset

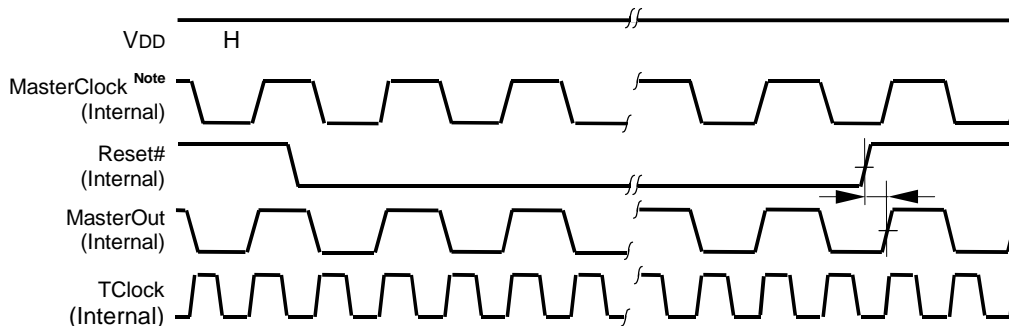

Note MasterClock is the basic clock used in the CPU core.

7.4 VR4102 PROCESSOR MODES

The VR4102 supports various modes, which can be selected by the user. The CPU core mode is set each time a write occurs in the Status register and Config register. The on-chip peripheral unit mode is set by writing to the I/O register.

This section describes the CPU core's operation modes. For operation modes of on-chip peripheral units, see the chapters describing the various units.

7.4.1 Power Modes

The VR4102 supports four power modes: Fullspeed mode, Standby mode, Suspend mode, and Hibernate mode.

www.DataSheet4U.com

(1) Fullspeed Mode

This is the normal operation mode.

The VR4102's default status sets operation under Fullspeed mode. After the processor is reset, the VR4102 returns to Fullspeed mode.

(2) Standby Mode

When a STANDBY instruction has been executed, the processor can be set to Standby mode. During Standby mode, all of the internal clocks in the CPU core except for the timer and interrupt clocks are held at high level. The peripheral units all operate as they do during Fullspeed mode. This means that DMA operations are enabled during Standby mode.

When the STANDBY instruction completes the WB stage, the VR4102 remains idle until the SysAD internal bus enters the idle state. Next, the clocks in the CPU core are shut down and pipeline operation is stopped. However, the PLL, timer, and interrupt clocks continue to operate, as do the internal bus clocks (TClock and MasterOut).

During Standby mode, the processor is returned to Fullspeed mode if any interrupt occurs, including a timer interrupt that occurs internally.

(3) Suspend Mode

When the SUSPEND instruction has been executed, the processor can be set to Suspend mode. During Suspend mode, the processor stalls the pipeline and supplying all of the internal clocks in the CPU core except for PLL timer and interrupt clocks are stopped. The VR4102 stops supplying TClock to peripheral units. Accordingly, during Suspend mode peripheral units can only be activated by a special interrupt unit (DCD# control, etc.). While in this mode, the register and cache contents are retained.

When the SUSPEND instruction completes the WB stage, the VR4102 switches the DRAM to self refresh mode and then waits for the SysAD internal bus to enter the idle state. Next, the clocks in the CPU core are shut down and pipeline operation is stopped. The VR4102 then stops supplying TClock to peripheral units. However, the PLL, timer, and interrupt clocks continue to operate, as do the MasterOut.

The processor remains in Suspend mode until an interrupt is received, at which time it returns to Fullspeed mode.

(4) Hibernate Mode

When the HIBERNATE instruction has been executed, the processor can be set to Hibernate mode. During Hibernate mode, the processor stops supplying clocks to all units. The register and cache contents are retained and output of TClock and MasterOut is stopped. The processor remains in Hibernate mode until the POWER pin is asserted, a WakeUpTimer interrupt occurs, DCD# pin is asserted, or GPIO[3] is asserted, at which the processor returns to Fullspeed mode.

Power consumption during Hibernate mode is about 0 W (it does not go completely to 0 W due to the existence of a 32.768-kHz oscillator, on-chip peripheral units that operate at 32.768 kHz, or DRAM self refresh).

7.4.2 Privilege Mode

The VR4102 supports three system modes: kernel expanded addressing mode, supervisor expanded addressing mode, and user expanded addressing mode. These three modes are described below.

(1) Kernel Expanded Addressing Mode

When the Status register's KX bit has been set, an expanded TLB miss exception vector is used when a TLB miss occurs for the kernel address. While in kernel mode, the MIPS III operation code can always be used, regardless of the KX bit.

(2) Supervisor Expanded Addressing Mode

When the Status register's SX bit has been set, the MIPS III operation code can be used when in supervisor mode and an expanded TLB miss exception vector is used when a TLB miss occurs for the supervisor address.

(3) User Expanded Addressing Mode

When the Status register's UX bit has been set, the MIPS III operation code can be used when in user mode, and an expanded TLB miss exception vector is used when a TLB miss occurs for the user address. When this bit is cleared, the MIPS I and II operation codes can be used, as can 32-bit virtual addresses.

7.4.3 Reverse Endian

When the Status register's RE bit has been set, the endian ordering is reversed to adopt the user software's perspective. However, the RE bit of the Status register must be set to 0 since the VR4102 supports the little-endian order only.

7.4.4 Bootstrap Exception Vector (BEV)

The BEV bit is used to generate an exception during operation testing (diagnostic testing) of the cache and main memory system. This bit is automatically set to 1 after reset or NMI exception.

When the Status register's BEV bit has been set, the address of the TLB miss exception vector is changed to the virtual address 0xFFFF FFFF BFC0 0200 and the ordinary execution vector is changed to address 0xFFFF FFFF BFC0 0380.

When the BEV bit is cleared, the TLB miss exception vector's address is changed to 0xFFFF FFFF 8000 0000 and the ordinary execution vector is changed to address 0xFFFF FFFF 8000 0180.

7.4.5 Cache Error Check

When the Status register's CE bit has been set, the contents of the PErr register can be written to the data cache's parity bit instead of the parity generated by the STORE instruction. If the CACHE instruction's "Fill" option is executed, the contents of the PErr register can be written to the instruction cache's parity bit instead of the instruction parity.

7.4.6 Parity Error Prohibit

When the Status register's DE bit has been set, the processor does not issue any cache parity error exceptions.

7.4.7 Interrupt Enable (IE)

When the Status register's IE bit has been cleared, no interrupts can be received except for reset interrupts and nonmaskable interrupts.

CHAPTER 8 CACHE MEMORY

This chapter describes in detail the cache memory: its place in the VR4100 CPU core memory organization, and individual organization of the caches.

This chapter uses the following terminology:

- ✧ The data cache may also be referred to as the D-cache.
- ✧ The instruction cache may also be referred to as the I-cache.

These terms are used interchangeably throughout this book.

www.DataSheet4U.com

8.1 MEMORY ORGANIZATION

Figure 8-1 shows the VR4100 CPU core system memory hierarchy. In the logical memory hierarchy, the caches lie between the CPU and main memory. They are designed to make the speedup of memory accesses transparent to the user.

Each functional block in Figure 8-1 has the capacity to hold more data than the block above it. For instance, physical main memory has a larger capacity than the caches. At the same time, each functional block takes longer to access than any block above it. For instance, it takes longer to access data in main memory than in the CPU on-chip registers.

Figure 8-1. Logical Hierarchy of Memory

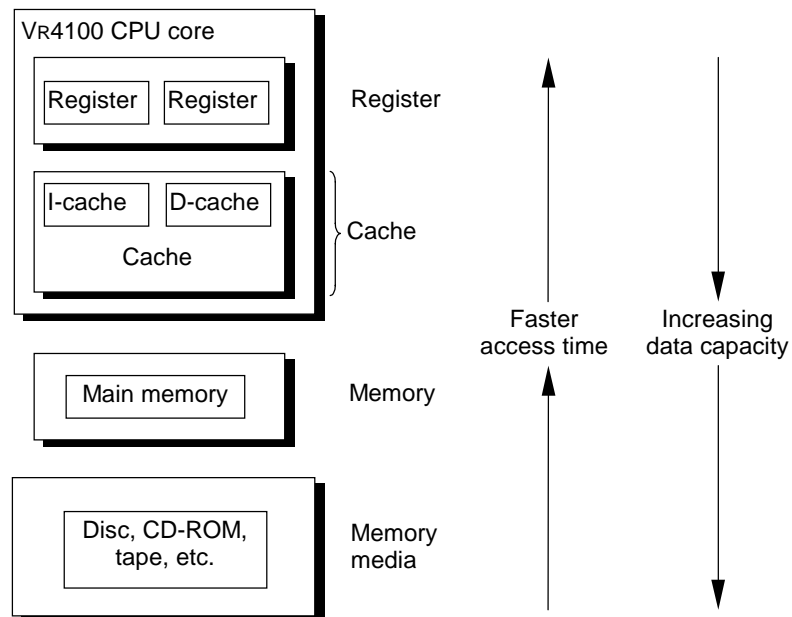

The VR4100 CPU core has two on-chip caches: one holds instructions (the instruction cache), the other holds data (the data cache). The instruction and data caches can be read in one PClock cycle.

Data writes are pipelined and can complete at a rate of one per PClock cycle. In the first stage of the cycle, the store address is translated and the tag is checked; in the second stage, the data is written into the data RAM.

8.2 CACHE ORGANIZATION

This section describes the organization of the on-chip data and instruction caches. Figure 8-2 provides a block diagram of the VR4100 CPU core cache and memory model.

Figure 8-2. Cache Support

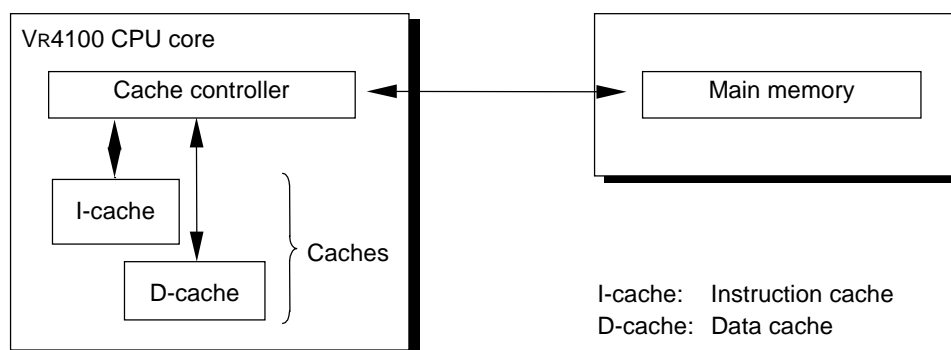

(1) Cache Line Lengths

A cache line is the smallest unit of information that can be fetched from main memory for the cache, and that is represented by a single tag.

The line size for the instruction/data cache is 4 words (16 bytes).

For cache tag, refer to 8.2.1 and 8.2.1.

(2) Cache Sizes

The instruction cache in the VR4100 CPU core is 4 Kbytes; the data cache is 1 Kbytes.

8.2.1 Organization of the Instruction Cache (I-Cache)

Each line of I-cache data (although it is actually an instruction, it is referred to as data to distinguish it from its tag) has an associated 24-bit tag that contains a 22-bit physical address, a single Valid bit, and a single Parity bit. Word parity is used on I-cache data (1 bit of parity per word).

The VR4100 CPU core I-cache has the following characteristics:

- ✧ direct-mapped
- ✧ indexed with a virtual address
- ✧ checked with a physical tag
- ✧ organized with a 4-word (16-byte) cache line.

Figure 8-3 shows the format of a 4-word (16-byte) I-cache line.

Figure 8-3. Cache Line Format

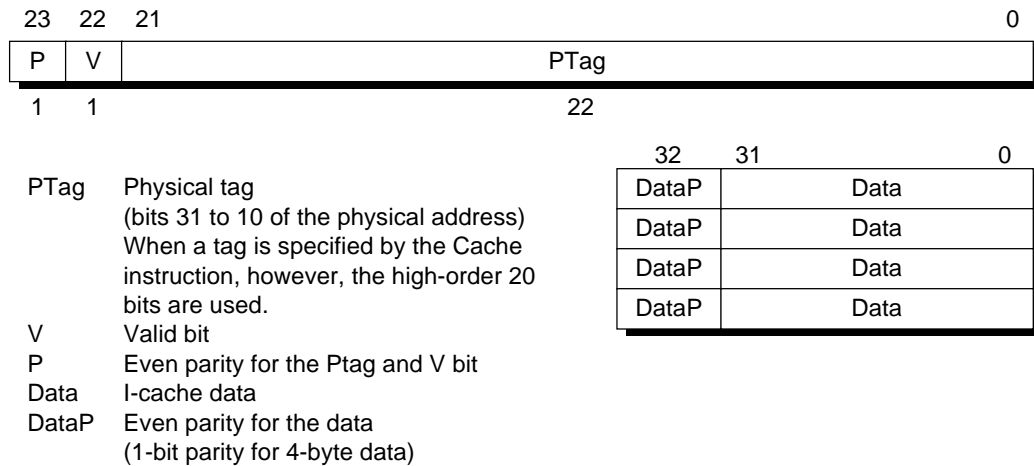

8.2.2 Organization of the Data Cache (D-Cache)

Each line of D-cache data has an associated 26-bit tag that contains a 22-bit physical address, a Valid bit, a Parity bit, a Write-back bit, and a parity bit for Write-back.

The VR4100 CPU core D-cache has the following characteristics :

- ✧ write-back
- ✧ direct-mapped
- ✧ indexed with a virtual address
- ✧ checked with a physical tag
- ✧ organized with a 4-word (16-byte) cache line.

Figure 8-4 shows the format of a 4-word (16-byte) D-cache line.

Figure 8-4. Data Cache Line Format

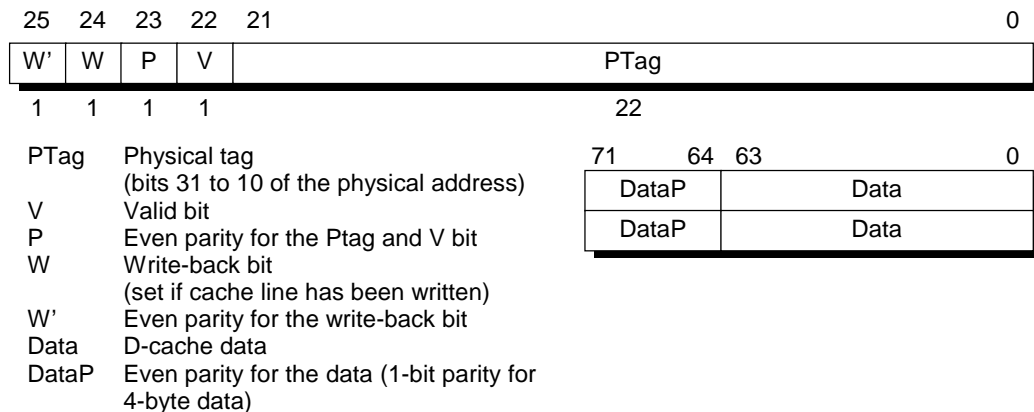

8.2.3 Accessing the Caches

Figure 8-5 shows the virtual address (VA) index into the caches. The number of virtual address bits used to index the instruction and data caches depends on the cache size.

(1) Data cache addressing

This addressing uses bits VA [9:4]. The most significant bit is VA9 because the cache size is 1 Kbyte. The least significant bit is VA4 because the line size is 4 words (16 bytes).

(2) Instruction cache addressing

This addressing uses bits VA [11:4]. The most significant bit is VA11 because the cache size is 4 Kbytes. The least significant bit is VA4 because the line size is 4 words (16 bytes).

www.DataSheet4U.com

Figure 8-5. Cache Data and Tag Organization

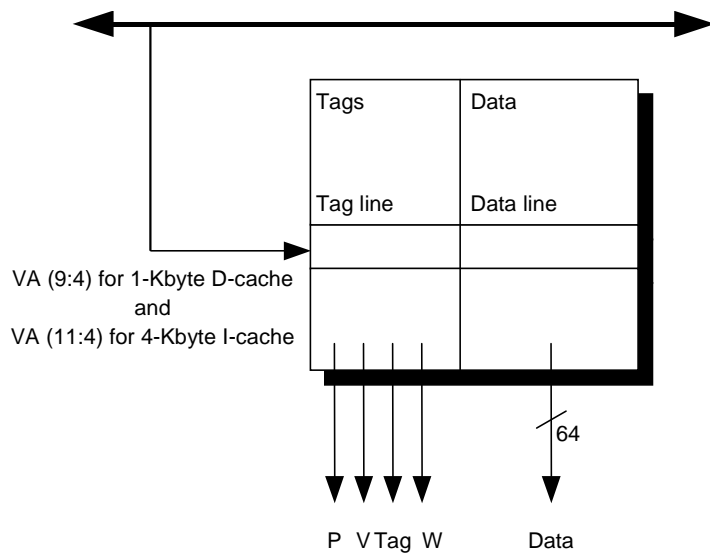

8.3 CACHE OPERATIONS

As described earlier, caches provide fast temporary data storage, and they make the speedup of memory accesses transparent to the user. In general, the CPU core accesses cache-resident instructions or data through the following procedure:

1. The CPU core, through the on-chip cache controller, attempts to access the next instruction or data in the appropriate cache.
2. The cache controller checks to see if this instruction or data is present in the cache.
 - ✧ If the instruction/data is present, the CPU core retrieves it. This is called a cache hit.
 - ✧ If the instruction/data is not present in the cache, the cache controller must retrieve it from memory. This is called a cache miss.
3. The CPU core retrieves the instruction/data from the cache and operation continues.

It is possible for the same data to be in two places (main memory and cache) simultaneously. This data is kept consistent through the use of a write-back methodology; that is, modified data is not written back to memory until the cache line is to be replaced.

Instruction and data cache line replacement operations are described in the following sections.

8.3.1 Cache Write Policy

The VR4100 CPU core manages its data cache by using a write-back policy; that is, it stores write data into the cache, instead of writing it directly to memory^{Note}. Some time later this data is independently written into memory. In the VR4102 implementation, a modified cache line is not written back to the main memory until the cache line is to be replaced either in the course of satisfying a cache miss, or during the execution of a write-back CACHE instruction.

When the CPU core writes a cache line back to the main memory, it does not ordinarily retain a copy of the cache line, and the state of the cache line is changed to invalid.

Note Write-through cache policy performs the function contrary to the write-back policy. Data written into memory is also written into cache simultaneously.

8.4 CACHE STATES

(1) Cache line

The three terms below are used to describe the state of a cache line:

- ✧ Dirty: a cache line containing data that has changed since it was loaded from memory.
- ✧ Clean: a cache line that contains data that has not changed since it was loaded from memory.
- ✧ Invalid: a cache line that does not contain valid information must be marked invalid, and cannot be used. For example, after a Soft Reset, software sets all cache lines to invalid. A cache line in any other state than invalid is assumed to contain valid information. Neither Cold reset nor Soft reset sets caches invalid. Software can invalidate caches.

www.DataSheet4U.com

(2) Data cache

The data cache supports three cache states:

- ✧ invalid
- ✧ valid clean
- ✧ valid dirty

(3) Instruction cache

The instruction cache supports two cache states:

- ✧ invalid
- ✧ valid

The state of a valid cache line may be modified when the processor executes a CACHE operation. CACHE operations are described in Chapter 27.

8.5 CACHE STATE TRANSITION DIAGRAMS

The following section describes the cache state diagrams for the data and instruction caches. These state diagrams do not cover the initial state of the system, since the initial state is system-dependent.

8.5.1 Data Cache State Transition

The following diagram illustrates the data cache state transition sequence. A load or store operation may include one or more of the atomic read and/or write operations shown in the state diagram below, which may cause cache state transitions.

www.DataSheet4U.com

- ✧ Read (1) indicates a read operation from memory to cache, inducing a cache state transition.
- ✧ Write (1) indicates a write operation from CPU core to cache, inducing a cache state transition.
- ✧ Read (2) indicates a read operation from cache to the CPU core, which induces no cache state transition.
- ✧ Write (2) indicates a write operation from CPU core to cache, which induces no cache state transition.

Figure 8-6. Data Cache State Diagram

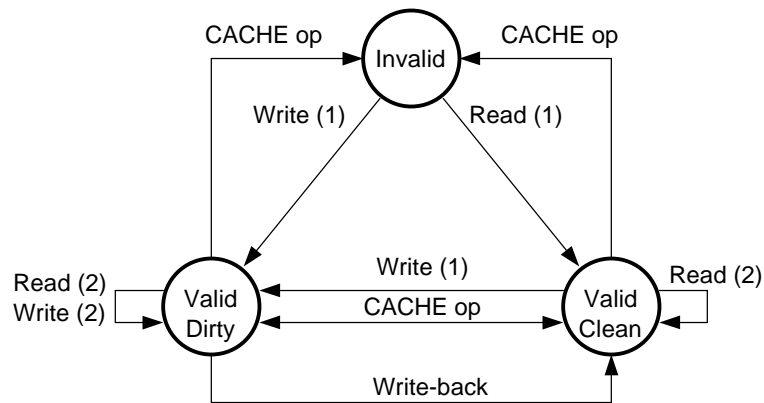

8.5.2 Instruction Cache State Transition

The following diagram illustrates the instruction cache state transition sequence.

- ✧ Read (1) indicates a read operation from memory to cache, inducing a cache state transition.
- ✧ Read (2) indicates a read operation from cache to the CPU core, which induces no cache state transition.

Figure 8-7. Instruction Cache State Diagram

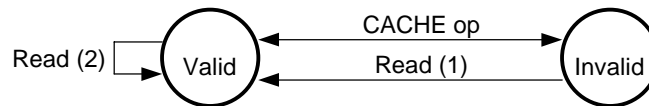

8.6 CACHE DATA INTEGRITY

The D- and I-cache data RAM arrays are protected by parity (byte parity for D-cache, word parity for I-cache). D- and I-cache tag RAM arrays are also protected by parity.

These parity bits are checked for errors on every cache read access. Cache error exception occurs if the CPU core encounters a parity error during an instruction cache access, a data cache access, or memory read access. The CacheErr register indicates the source of the error.

Figure 8-8 to Figure 8-22 shows the parity generation and checking operations for various cache accesses.

Figure 8-8. Data flow on Instruction Fetch

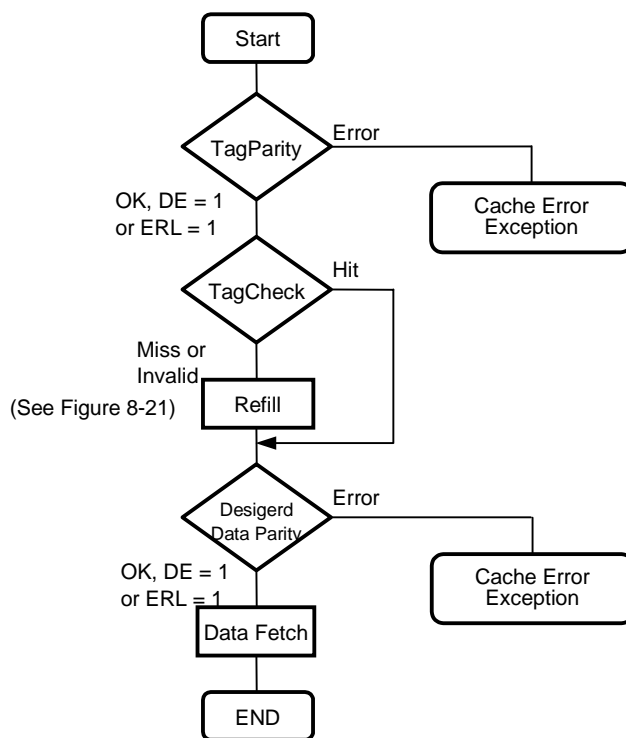
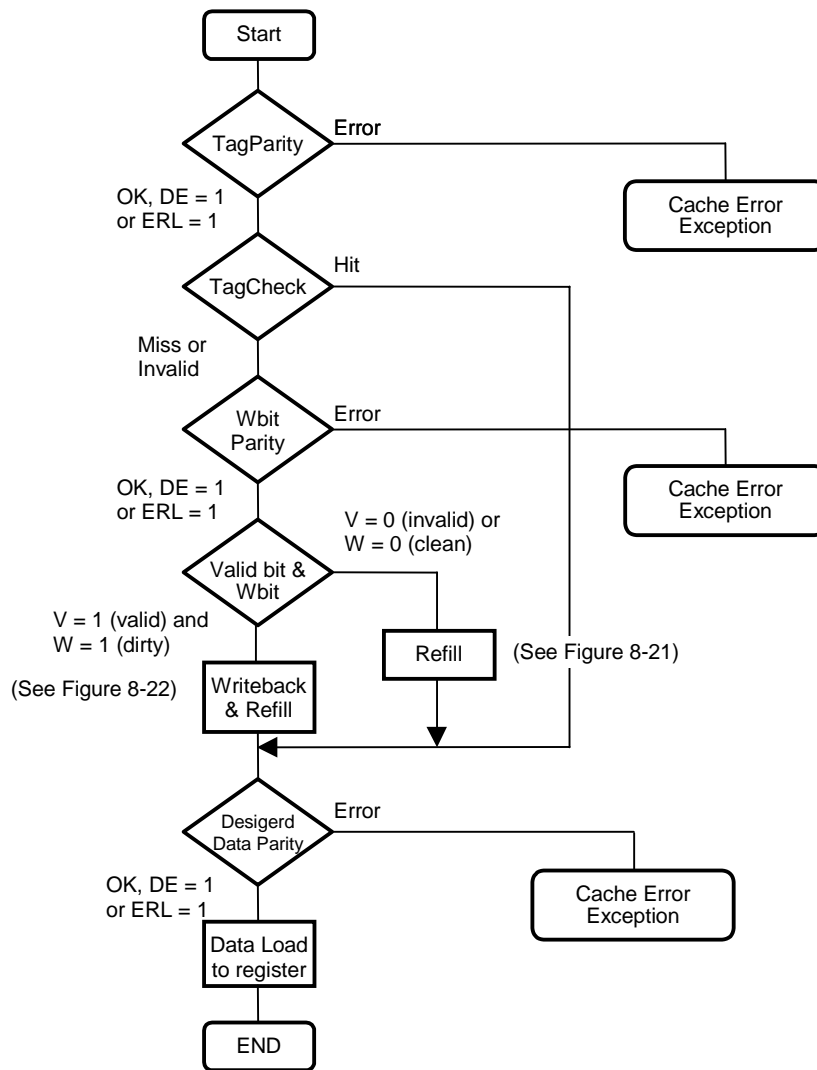
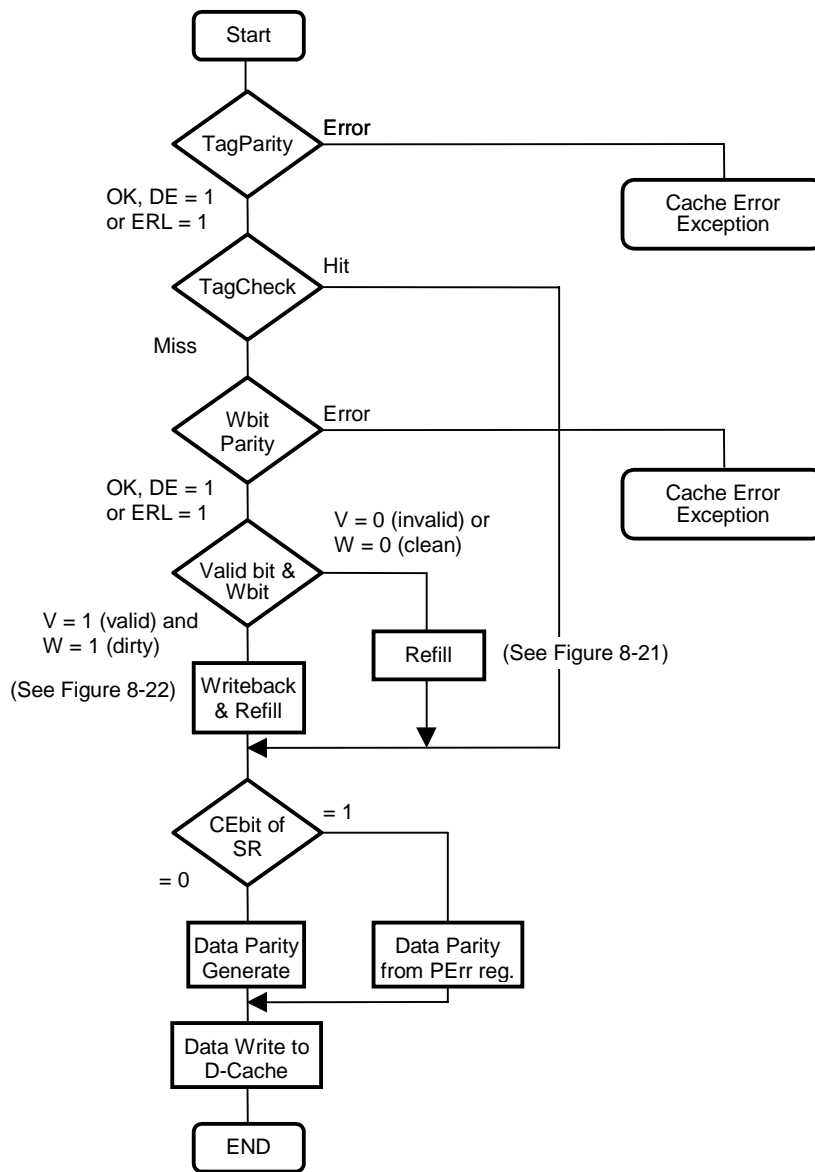

Figure 8-9. Data Integrity on Load Operations



www.DataSheet4U.com

Figure 8-10. Data Integrity on Store Operations



www.DataSheet4U.com

Figure 8-11. Data Integrity on Index_Invalidate Operations

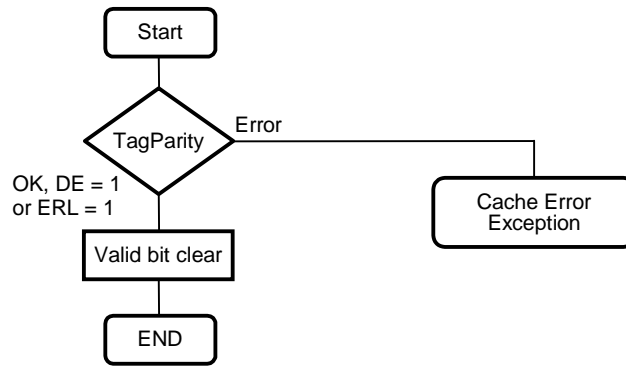

Figure 8-12. Data Integrity on Index_Writeback_Invalidate Operations

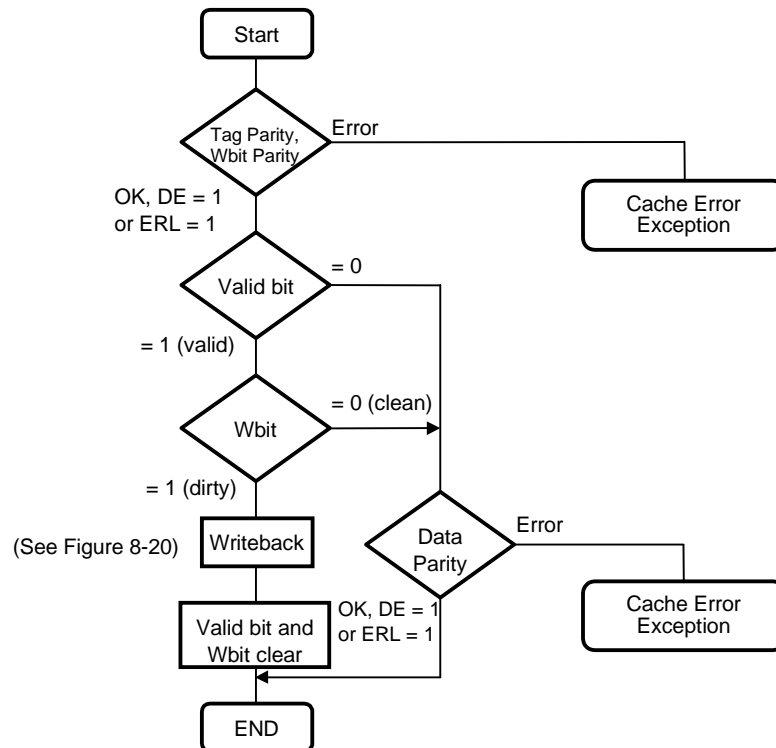
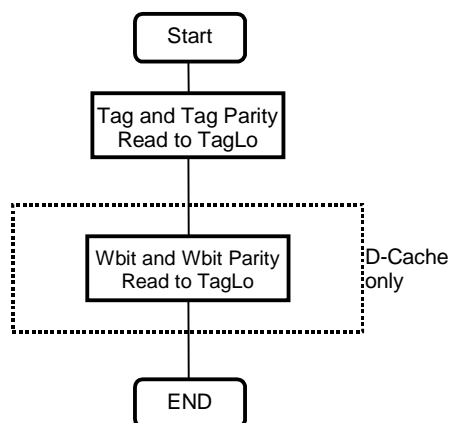

Figure 8-13. Data Integrity on Index_Load_Tag Operations



www.DataSheet4U.com

Figure 8-14. Data Integrity on Index_Store_Tag Operations

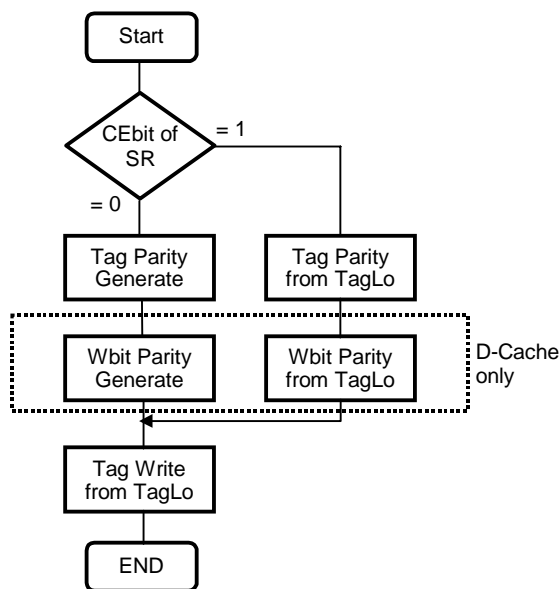

Figure 8-15. Data Integrity on Create_Dirty Operations

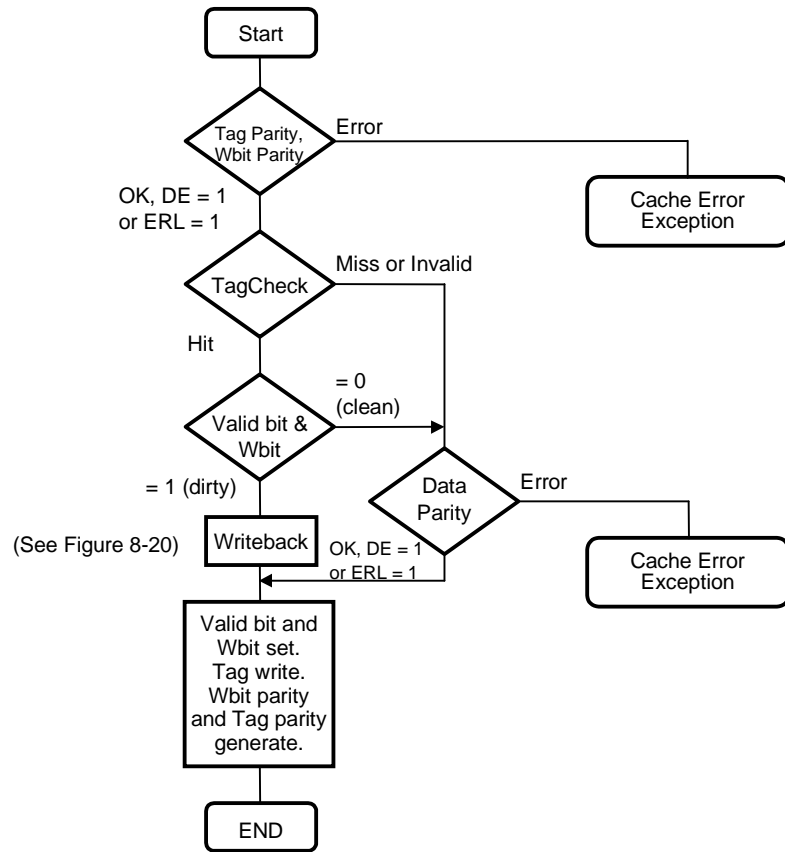

Figure 8-16. Data Integrity on Hit_Invalidate Operations

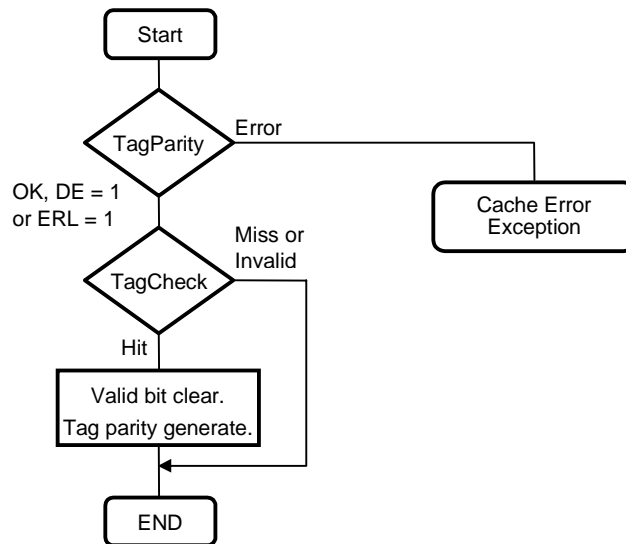

Figure 8-17. Data Integrity on Hit_Writeback_Invalidate Operations

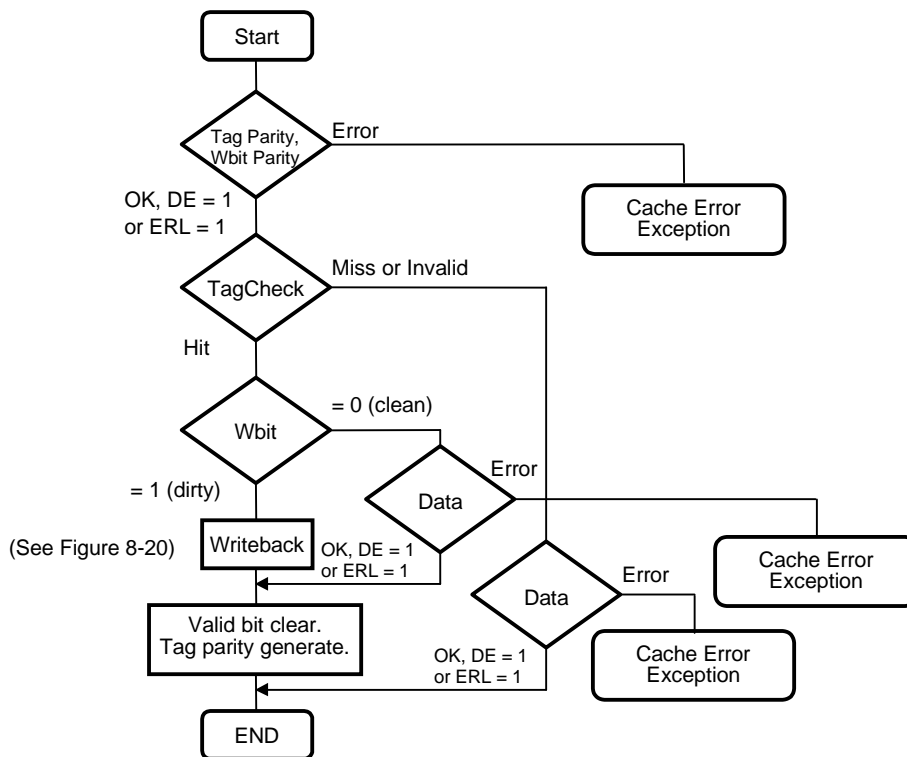

Figure 8-18. Data Integrity on Fill Operations

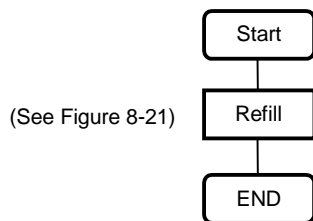
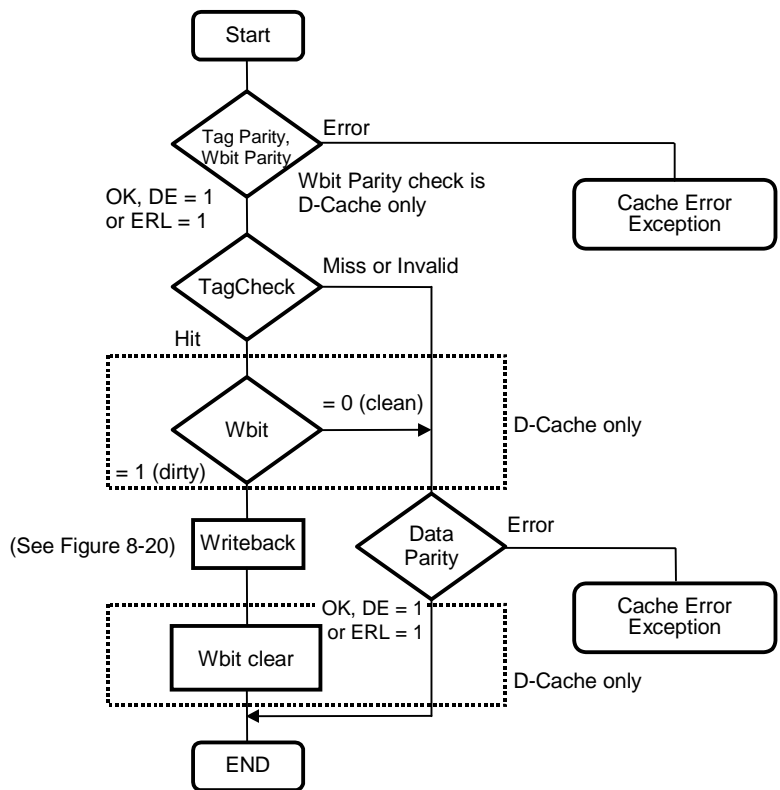

Figure 8-19. Data Integrity on Hit_Writeback Operations



www.DataSheet4U.com

Figure 8-20. Data Integrity on Writeback Flow

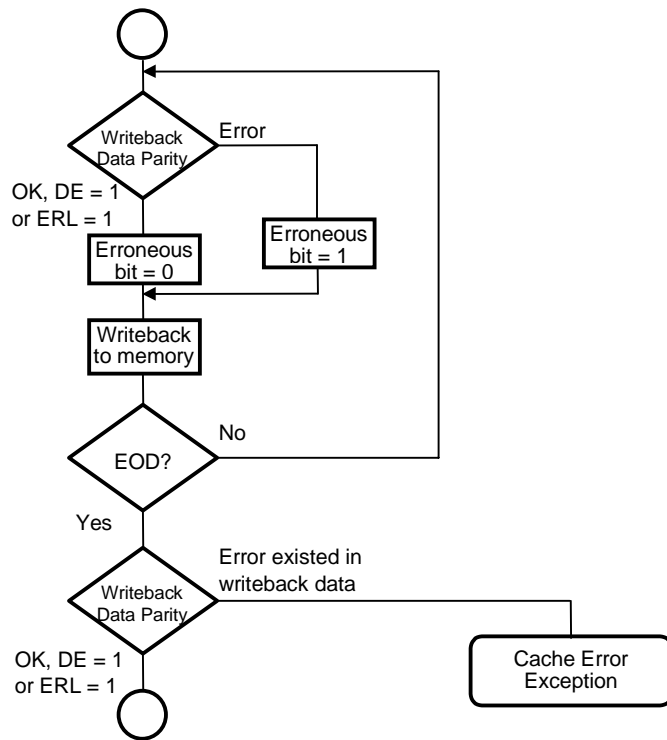

Figure 8-21. Data Integrity on Refill Flow

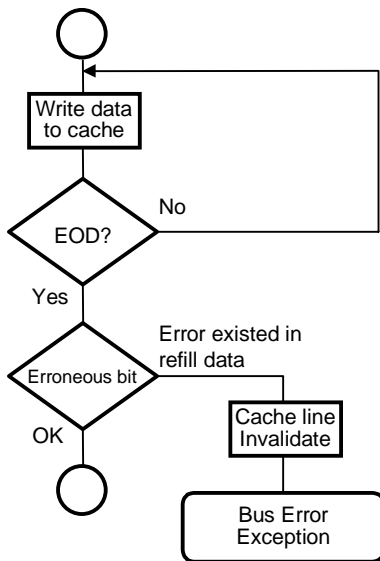
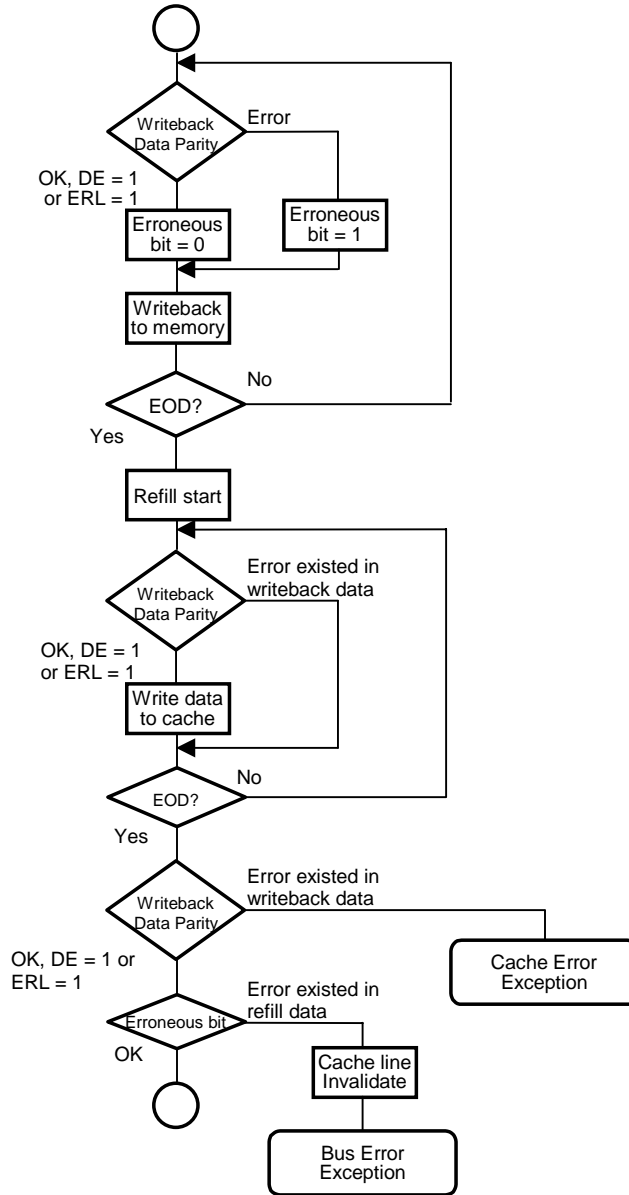

Figure 8-22. Data Integrity on Writeback & Refill Flow



Remark Write-back Procedure:

On a store miss write-back, data tag and tag parity are checked and data parity is transferred to the write buffer. Byte parity is generated for the physical address and transferred to write buffer. If an error is detected on the data field, the write back is not terminated; the erroneous data is still written out. If an error is detected in the tag field, the write-back bus cycle is not issued. In both cases a cache error exception is taken.

During a Cache operation, cache data may not be checked in some cases, but tag parity is always checked. At that time, if a tag parity error occurs, the Cache Error exception is taken and the operation is not permitted to complete.

8.7 MANIPULATION OF THE CACHES BY AN EXTERNAL AGENT

The VR4102 does not provide any mechanisms for an external agent to examine and manipulate the state and contents of the caches.

CHAPTER 9 CPU CORE INTERRUPTS

Four types of interrupt are available on the CPU core. These are:

- ✧ one non-maskable interrupt, NMI
- ✧ five ordinary interrupts
- ✧ two software interrupts
- ✧ one timer interrupt

These are described in this chapter.

www.DataSheet4U.com

9.1 NON-MASKABLE INTERRUPT (NMI)

The non-maskable interrupt request signal is acknowledged by asserting the NMI signal (internal), forcing the processor to branch to the Reset Exception vector. This NMI signal is latched into an internal register at the rising edge of MasterOut, as shown in Figure 9-1.

NMI only takes effect when the processor pipeline is running.

This interrupt cannot be masked.

Figure 9-1 shows the internal derivation of the NMI signal. The NMI signal is latched into an internal register at the rising edge of MasterOut. The latched NMI signal is inverted and then transmitted as an NMI request.

Figure 9-1. Non-maskable Interrupt Signal

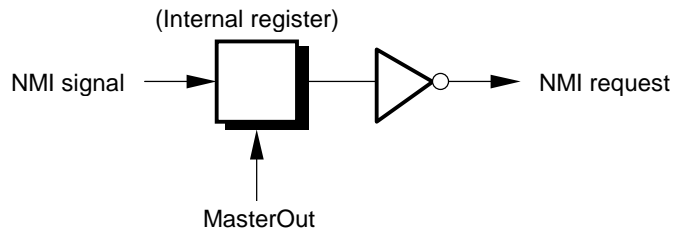

9.2 ORDINARY INTERRUPTS

Ordinary interrupts are set by asserting the Int(4:0) signals (internal). **However, Int4 never occur on the VR4102.**

These interrupts can be masked with the IM(6..2), IE, and EXL fields of the Status register.

9.3 SOFTWARE INTERRUPTS GENERATED IN CPU CORE

Software interrupts generated in the CPU core are acknowledged by setting bits 1 and 0 of the IP (interrupt pending) field in the Cause register. These may be written by software, but there is no hardware mechanism to set or clear these bits.

After the processing of a software interrupt exception, corresponding bit of the IP field in the Cause register must be cleared before returning to ordinary routine or enabling multiple interrupts.

These interrupts are maskable through the IM(1:0), IE, and EXL fields of the Status register.

9.4 TIMER INTERRUPT

The timer interrupt uses bit 15 of the Cause register, which is bit 7 of the IP (interrupt pending) field. This bit is automatically set whenever the value of the Count register equals the value of the Compare register, to acknowledge an interrupt request. This interrupt is maskable by setting IM7 of the Status register.

9.5 ASSERTING INTERRUPTS

9.5.1 Detecting Hardware Interrupts

Figure 9-2 shows how the hardware interrupt request is detected through the Cause register.

- ✧ The timer interrupt signal, IP7, is directly readable as bit 15 of the Cause register.
- ✧ Bits 4:0 of the Interrupt register are bit-wise ORed with the current value of the Int(4:0) signals and the result is directly readable as bits 14:10 of the Cause register.

IP(1:0) of the Cause register, which are described in Chapter 6, are software interrupts. There is no hardware mechanism for setting or clearing the software interrupts.

Figure 9-2. Hardware Interrupt Signals

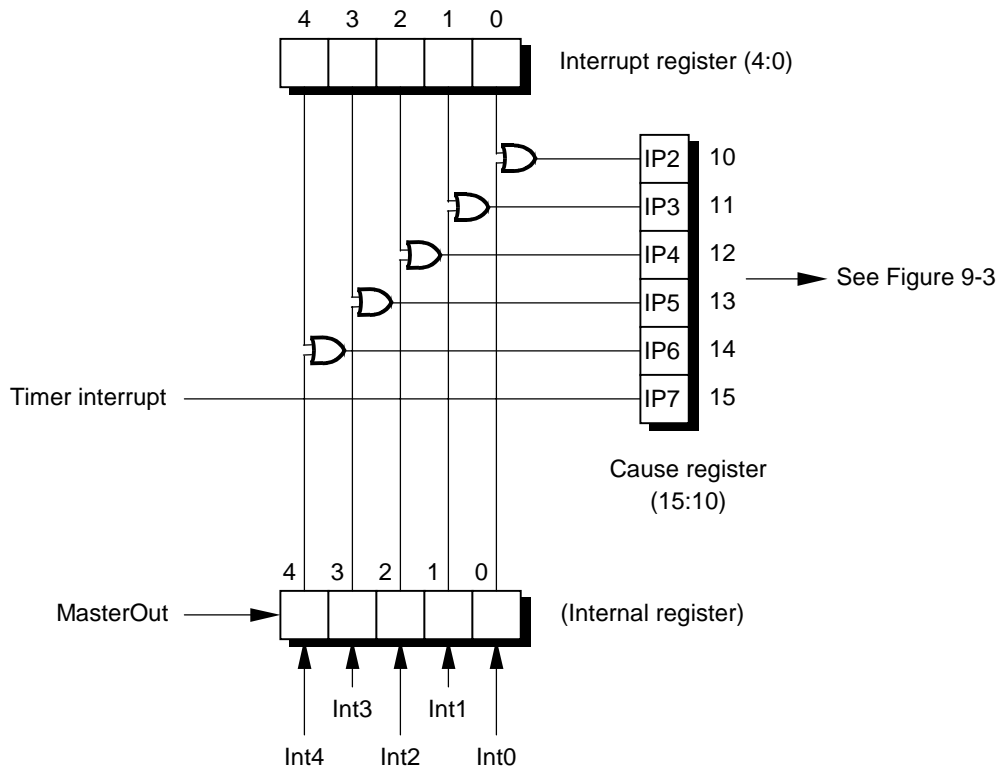

www.DataSheet4U.com

Remark Int4 never occurs in the VR4102.

9.5.2 Masking Interrupt Signals

Figure 9-3 shows the masking of the CPU core interrupt signals.

- ✧ Cause register bits 15 to 8 (IP7 to IP0) are AND-ORed with Status register interrupt mask bits 15 to 8 (IM7 to IM0) to mask individual interrupts.
- ✧ Status register bit 0 is a global Interrupt Enable bit (IE). It is ANDed with the output of the AND-OR logic to produce the CPU core interrupt signal. The EXL bit in the Status register also enables these interrupts.

Figure 9-3. Masking of the CPU Core Interrupts

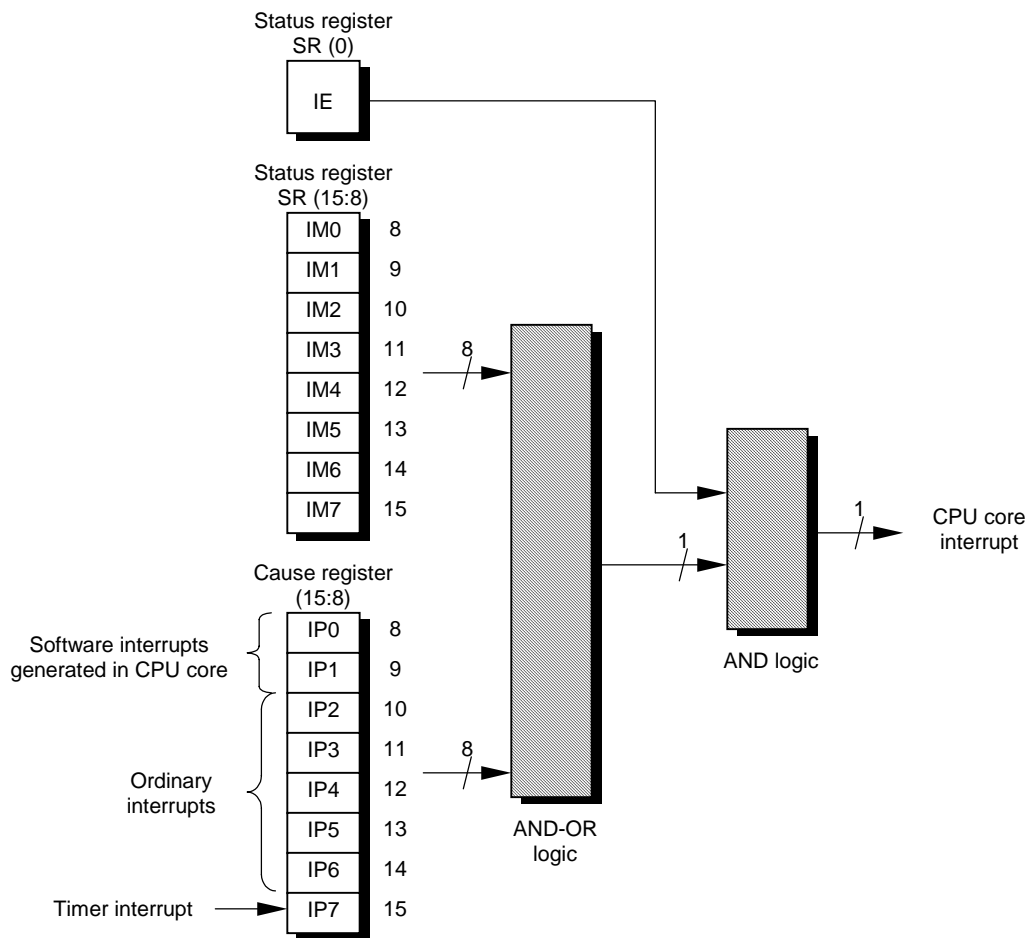

Bit	Function	Setting
IE	Interrupt enable for all interrupts	1: Enable 0: Disable
IM (7:0)	Interrupt mask	1: Enable for individual bits 0: Disable for individual bits
IP (7:0)	Interrupt request	1: Pending request for individual bits 0: No pending for individual bits

CHAPTER 10 BCU (BUS CONTROL UNIT)

This chapter describes the BCU's operations and register settings.

10.1 GENERAL

In the VR4102, the BCU receives data that has passed via the VR4100 CPU core and the SysAD bus. The BCU also controls external agents via the system bus, such as an LCD controller, DRAM, ROM (Flash memory or masked ROM), or PCMCIA controller, and it transmits and receives data with these external agents via the ADD bus and DATA bus.

www.DataSheet4U.com

10.2 REGISTER SET

The BCU registers are listed below.

Table 10-1. BCU Registers

Address	R/W	Register symbols	Function
0x0B00 0000	R/W	BCUCNTREG 1	BCU Control Register 1
0x0B00 0002	R/W	BCUCNTREG 2	BCU Control Register 2
0x0B00 000A	R/W	BCUSPEEDREG	BCU Access Cycle Change Register
0x0B00 000C	R/W	BCUERRSTREG	BCU BUS ERROR Status Register
0x0B00 000E	R/W	BCURFCNTREG	BCU Refresh Control Register
0x0B00 0010	R	REVIDREG	Revision ID Register
0x0B00 0012	R/W	BCURFCOUNTREG	BCU Refresh Count Register
0x0B00 0014	R/W	CLKSPEEDREG	Clock Speed Register

Each register is described in detail as follows.

10.2.1 BCUCNTREG 1 (0x0B00 0000)

(1/2)

Bit	D15	D14	D13	D12	D11	D10	D9	D8
Name	ROM64	DRAM64	ISAM/LCD	PAGE128	Reserved	PAGEROM2	Reserved	PAGEROM0
R/W	R/W	R/W	R/W	R/W	R	R/W	R	R/W
RTCST	0	0	0	0	0	0	0	0
Other resets	0	0	0	0	0	0	0	0

Bit	D7	D6	D5	D4	D3	D2	D1	D0
Name	Reserved	ROMWEN2	Reserved	ROMWEN0	Reserved	Reserved	BUSHERREN	RSTOUT
R/W	R	R/W	R	R/W	R	R	R/W	R/W
RTCST	0	0	0	0	0	0	0	0
Other resets	0	0	0	0	0	0	0	0

Bit	Name	Function
D[15]	ROM64	Sets the capacity of the ROM to be used 1: 64M-bit ROM 0: 32M-bit ROM
D[14]	DRAM64	Sets the capacity of the DRAM to be used 1 : 64M-bit DRAM 0 : 16M-bit DRAM
D[13]	ISAM/LCD	Assigns space from 0x0A00 0000 to 0x0AFF FFFF as the physical address space. 1 : As ISA high-speed memory space 0 : As LCD space
D[12]	PAGE128	Sets the maximum burst acceleration size for Page ROM. 1 : 128-bit (16 byte) 0 : 64-bit (8 byte)
D[11]	Reserved	Write 0 when writing. 0 is returned after a read.
D[10]	PAGEROM2	This is the page ROM access enable bit for the ROM space in banks 3 and 2 (16-bit mode) or in bank 1 (32-bit mode). 1 : Page ROM 0 : Ordinary ROM
D[9]	Reserved	Write 0 when writing. 0 is returned after a read.
D[8]	PAGEROM0	This is the page ROM access enable bit for the ROM space in banks 1 and 0 (16-bit mode) or in bank 0 (32-bit mode). 1 : Page ROM 0 : Ordinary ROM

Bit	Name	Function
D[7]	Reserved	Write 0 when writing. 0 is returned after a read.
D[6]	ROMWEN2	This enables flash memory write and issues a flash memory register read-only bus cycle for the ROM space in banks 3 and 2 (16-bit mode) or in bank 1 (32-bit mode). 1 : Enable (Not affected by PAGEROM2) 0 : Prohibit
D[5]	Reserved	Write 0 when writing. 0 is returned after a read.
D[4]	ROMWEN0	This enables flash memory write and issues a flash memory register read-only bus cycle for the ROM space in banks 1 and 0 (16-bit mode) or in bank 0 (32-bit mode). 1 : Enable (Not affected by PAGEROM0) 0 : Prohibit
D[3..2]	Reserved	Write 0 when writing. 0 is returned after a read.
D[1]	BUSHERREN	This is the bus timeout detection enable bit, which is used when a bus hold has been received. 1 : Performs timeout detection when a bus hold has been received. 0 : Does not perform timeout detection when a bus hold has been received.
D[0]	RSTOUT	RSTOUT control bit 1 : High level 0 : Low level

This register is used to set parameters such as the bus interface's bus cycle.

For the setting of the PAGEROM2 and ROMWEN2 bits, the target ROM area differs depending on a data bus mode. The access target ROM area is banks 3 and 2 in 16-bit data bus mode, and bank 1 in 32-bit data bus mode.

For the setting of the PAGEROM0 and ROMWEN0 bits, the target ROM area differs depending on the data bus mode. The access target ROM area is banks 1 and 0 in 16-bit data bus mode, and bank 0 in 32-bit data bus mode.

When a timeout is detected while the BUSHERREN bit is set to 1, the BERRST bit of the BCUERRSTREG register is set to 1 and an interrupt request is sent to the CPU. The RSTOUT pin is set to high to request bus release from the external bus master.

10.2.2 BCUCNTREG 2 (0x0B00 0002)

Bit	D15	D14	D13	D12	D11	D10	D9	D8
Name	Reserved	Reserved	Reserved	Reserved	Reserved	Reserved	Reserved	Reserved
R/W	R	R	R	R	R	R	R	R
RTCRST	0	0	0	0	0	0	0	0
Other resets	0	0	0	0	0	0	0	0

Bit	D7	D6	D5	D4	D3	D2	D1	D0
Name	Reserved	Reserved	Reserved	Reserved	Reserved	Reserved	Reserved	GMODE
R/W	R	R	R	R	R	R	R	R/W
RTCRST	0	0	0	0	0	0	0	0
Other resets	0	0	0	0	0	0	0	0

Bit	Name	Function
D[15..1]	Reserved	Write 0 when writing. 0 is returned after a read.
D[0]	GMODE	This is the access data control bit for LCD space. 1 : Do not invert the access data for LCD space 0 : Invert the access data for LCD space

This register is used to specify whether data is inverted (translated to 2's complement) or not when accessing the LCD space.

The LCD space is accessed when the ISAM/LCD bit of BCUCNTREG1 is 0. When it is 1, this address space is used as the ISA high-speed memory space. In this case, the contents of the BCUCNTREG2 register are invalid, and inversion of access data is not performed.

10.2.3 BCUSPEEDREG (0x0B00 000A)

(1/2)

Bit	D15	D14	D13	D12	D11	D10	D9	D8
Name	Reserved	Reserved	WPROM[1]	WPROM[0]	Reserved	WLCD/M[2]	WLCD/M[1]	WLCD/M[0]
R/W	R	R	R/W	R/W	R	R/W	R/W	R/W
RTCST	0	0	0	0	0	0	0	0
Other resets	0	0	0	0	0	0	0	0

Bit	D7	D6	D5	D4	D3	D2	D1	D0
Name	Reserved	WISAA [2]	WISAA [1]	WISAA [0]	Reserved	WROMA[2]	WROMA[1]	WROMA[0]
R/W	R	R/W	R/W	R/W	R	R/W	R/W	R/W
RTCST	0	0	0	0	0	0	0	0
Other resets	0	0	0	0	0	0	0	0

Bit	Name	Function
D[15..14]	Reserved	Write 0 when writing. 0 is returned after a read.
D[13..12]	WPROM[1..0]	Page ROM access speed 11 : RFU 10 : 1TClock 01 : 2TClock 00 : 3TClock
D[11]	Reserved	Write 0 when writing. 0 is returned after a read.
D[10..8]	WLCD/M[2..0]	Access speed to physical address space from 0x0A00 0000 to 0x0AFF FFFF LCD(ISAM/LCD=0) ISA-MEM(ISAM/LCD=1) 111 : RFU 1TClock 110 : RFU 2TClock 101 : RFU 3TClock 100 : RFU 4TClock 011 : 2TClock 5TClock 010 : 4TClock 6TClock 001 : 6TClock 7TClock 000 : 8TClock 8TClock
D[7]	Reserved	Write 0 when writing. 0 is returned after a read.

Bit	Name	Function
D[6..4]	WISAA[2..0]	System bus access speed 111 : RFU. Operation is not guaranteed when this value has been set. 110 : RFU. Operation is not guaranteed when this value has been set. 101 : 3TClock ^{Note} 100 : 4TClock ^{Note} 011 : 5TClock 010 : 6TClock 001 : 7TClock 000 : 8TClock
D[3]	Reserved	Write 0 when writing. 0 is returned after a read.
D[2..0]	WROMA[2..0]	ROM access speed 111 : 2TClock 110 : 3TClock 101 : 4TClock 100 : 5TClock 011 : 6TClock 010 : 7TClock 001 : 8TClock 000 : 9TClock

Note When the WISAA [2:0] bits are set to 101 or 100, the AC characteristics between BUSCLK and the system bus interface signals (ADD [25:0], SHB#, MEMR#, MEMW#, IOR#, and IOW#) are not guaranteed.

This register is used to set the access speed for the LCD, system bus, page ROM, and ROM.

The lowest speed is set when "0" is set to all of the following bits: WLCD/M[2..0], WPROM[1..0], WISAA[2..0], and WROMA[2..0]. Setting "1" to all of these bits sets the highest speed.

The value set to WPROM[1..0] is valid only when "1" has been set to the PAGEROM bit in BCUCNTREG.

10.2.4 BCUERRSTREG (0x0B00 000C)

Bit	D15	D14	D13	D12	D11	D10	D9	D8
Name	Reserved	Reserved	Reserved	Reserved	Reserved	Reserved	Reserved	Reserved
R/W	R	R	R	R	R	R	R	R
RTCRST	0	0	0	0	0	0	0	0
Other resets	0	0	0	0	0	0	0	0

Bit	D7	D6	D5	D4	D3	D2	D1	D0
Name	Reserved	Reserved	Reserved	Reserved	Reserved	Reserved	Reserved	BERRST
R/W	R	R	R	R	R	R	R	R/W1C
RTCRST	0	0	0	0	0	0	0	0
Other resets	0	0	0	0	0	0	0	0

Bit	Name	Function
D[15..1]	Reserved	Write 0 when writing. 0 is returned after a read.
D[0]	BERRST	Bus error status. Clear to 0 when 1 is written. 1 : Bus error 0 : Normal

This register is used to indicate when a bus error interrupt request has occurred.

10.2.5 BCURFCNTREG (0x0B00 000E)

Bit	D15	D14	D13	D12	D11	D10	D9	D8
Name	Reserved	Reserved	BRF[13]	BRF[12]	BRF[11]	BRF[10]	BRF[9]	BRF[8]
R/W	R	R	R/W	R/W	R/W	R/W	R/W	R/W
RTCRST	0	0	0	0	0	0	1	0
Other resets	0	0	Undefined	Undefined	Undefined	Undefined	Undefined	Undefined

Bit	D7	D6	D5	D4	D3	D2	D1	D0
Name	BRF[7]	BRF[6]	BRF[5]	BRF[4]	BRF[3]	BRF[2]	BRF[1]	BRF[0]
R/W	R/W	R/W	R/W	R/W	R/W	R/W	R/W	R/W
RTCRST	0	0	0	0	0	0	0	0
Other resets	Undefined	Undefined	Undefined	Undefined	Undefined	Undefined	Undefined	Undefined

Bit	Name	Function
D[15..14]	Reserved	Write 0 when writing. 0 is returned after a read.
D[13..0]	BRF[13..0]	Use this bit to set the number of refresh cycles (with Tclock cycle).

This register is used to specify the number of refresh cycles (with Tclock cycle).

10.2.6 REVIDREG (0x0B00 0010)

Bit	D15	D14	D13	D12	D11	D10	D9	D8
Name	RID[3]	RID[2]	RID[1]	RID[0]	MJREV[3]	MJREV[2]	MJREV[1]	MJREV[0]
R/W	R	R	R	R	R	R	R	R
RTCRST	0	0	0	1	Undefined	Undefined	Undefined	Undefined
Other resets	0	0	0	1	Undefined	Undefined	Undefined	Undefined

Bit	D7	D6	D5	D4	D3	D2	D1	D0
Name	Reserved	Reserved	Reserved	Reserved	MNREV[3]	MNREV[2]	MNREV[1]	MNREV[0]
R/W	R	R	R	R	R	R	R	R
RTCRST	0	0	0	0	Undefined	Undefined	Undefined	Undefined
Other resets	0	0	0	0	Undefined	Undefined	Undefined	Undefined

Bit	Name	Function
D[15..12]	RID[3:0]	This is the processor revision ID. 0x01 indicates the Vr4102.
D[11..8]	MJREV[3..0]	Major revision number
D[7..4]	Reserved	Write 0 when writing. 0 is returned after a read.
D[3..0]	MNREV[3..0]	Minor revision number

This register is used to indicate revisions of the Vr4102's peripheral units.

The revision number is stored as a value in the form $y.x$, where y is a major revision number and x is a minor revision number.

Major revision number and minor revision number can distinguish the revision of the CPU and the peripheral units, however there is no guarantee that changes to the CPU and the peripheral units will necessarily be reflected in this register, or that changes to the revision number necessarily reflect real CPU's and units' changes. For this reason, these values are not listed and software should not rely on the revision number in PREVIDREG to characterize the units.

10.2.7 BCURFCOUNTREG (0x0B00 0012)

Bit	D15	D14	D13	D12	D11	D10	D9	D8
Name	Reserved	Reserved	BRFC[13]	BRFC[12]	BRFC[11]	BRFC[10]	BRFC[9]	BRFC[8]
R/W	R	R	R/W	R/W	R/W	R/W	R/W	R/W
RTCRST	0	0	0	0	0	0	0	0
Other resets	0	0	0	0	0	0	0	0

Bit	D7	D6	D5	D4	D3	D2	D1	D0
Name	BRFC[7]	BRFC[6]	BRFC[5]	BRFC[4]	BRFC[3]	BRFC[2]	BRFC[1]	BRFC[0]
R/W	R/W	R/W	R/W	R/W	R/W	R/W	R/W	R/W
RTCRST	0	0	0	0	0	0	0	0
Other resets	0	0	0	0	0	0	0	0

Bit	Name	Function
D[15..14]	Reserved	Write 0 when writing. 0 is returned after a read.
D[13..0]	BRFC[13..0]	This is the down counter that counts the number of refresh cycles (with TClock cycle).

This register is used to indicate the current refresh cycle count value.

10.2.8 CLKSPEEDREG (0x0B00 0014)

Bit	D15	D14	D13	D12	D11	D10	D9	D8
Name	DIV2B	Reserved	Reserved	Reserved	Reserved	Reserved	Reserved	Reserved
R/W	R	R	R	R	R	R	R	R
RTCRST	0	0	0	0	0	0	0	0
Other resets	0	0	0	0	0	0	0	0

Bit	D7	D6	D5	D4	D3	D2	D1	D0
Name	Reserved	Reserved	Reserved	CLKSP[4]	CLKSP[3]	CLKSP[2]	CLKSP[1]	CLKSP[0]
R/W	R	R	R	R	R	R	R	R
RTCRST	0	0	0	Undefined	Undefined	Undefined	Undefined	Undefined
Other resets	0	0	0	Undefined	Undefined	Undefined	Undefined	Undefined

Bit	Name	Function
D[15]	DIV2B	The multiplier of TClock frequency. This bit always indicates 0 in the current VR4102. 1: Reserved 0: Multiplied by 16
D[14..5]	Reserved	Write 0 when writing. 0 is returned after a read.
D[4..0]	CLKSP[4..0]	These bits indicate the value used to calculate the frequency of PClock and TClock.

This register is used to indicate the value to calculate the frequencies of the peripheral unit's operating clock (TClock) and CPU core's operating clock (PClock). The PClock frequency obtained from this register's setting is the same as the frequency selected by setting CLKSEL[2:0] pins.

The following method is used to calculate TClock frequency.

$$TClock = (18.432 \text{ MHz}/CLKSP[4..0]) * 16$$

The following method is used to calculate PClock frequency.

$$PClock = (18.432 \text{ MHz}/CLKSP[4..0]) * 32$$

10.3 CONNECTION OF ADDRESS PINS

Physical address output from the CPU core is provided to external devices through ADD bus. The correspondence between the address output to ADD bus and the address bits of external devices differs depending on the external devices as shown in Table 10-2. Therefore, connect ADD bus and address pin of the external device as shown in Table 10-3.

Table 10-2. Address Bit Correspondence between ADD Bus and External Devices

Devices connected	ADD bus																									
	0	1	2	3	4	5	6	7	8	9	10	11	12	13	14	15	16	17	18	19	20	21	22	23	24	25
ROM, LCD, ISA, DRAM (ROW)	0	1	2	3	4	5	6	7	8	9	10	11	12	13	14	15	16	17	18	19	20	21	22	23	24	25
DRAM (COLUMN), DATA [15:0]	0	1	2	3	4	5	6	7	8	1	2	3	4	5	6	7	8	19	20	19	20	21	22	23	24	25
DRAM (COLUMN), DATA [31:0]	0	1	2	3	4	5	6	7	8	21	2	3	4	5	6	7	8	19	20	19	20	21	22	23	24	25

Table 10-3. Address Connection Table with External Devices

V _R 4102 pin	Address bits of external devices		
	16M-bit DRAM	64M-bit DRAM, DATA[15..0]	64M-bit DRAM, DATA[31..0]
ADD[9]	A0	A0	A0
ADD[10]	A1	A1	A1
ADD[11]	A2	A2	A2
ADD[12]	A3	A3	A3
ADD[13]	A4	A4	A4
ADD[14]	A5	A5	A5
ADD[15]	A6	A6	A6
ADD[16]	A7	A7	A7
ADD[17]	A8	A8	A8
ADD[18]	A9	A9	A9
ADD[19]	A10/NC ^{Note 1}	-	-
ADD[20]	A11/NC ^{Note 1}	A12/NC ^{Note 2}	A12/NC ^{Note 3}
ADD[21]	-	A10	-
ADD[22]	-	A11	A10
ADD[23]	-	-	A11

- Notes 1.** A10, A11 : μ PD42S16165, NC : μ PD42S18165
2. A12 : μ PD42S64165, NC : μ PD42S65165
3. A12 : μ PD42S64165, NC : μ PD42S65165

10.4 NOTES ON USING BCU

10.4.1 CPU Core Bus Modes

The VR4102 is designed on the assumption that the CPU core is set to the following mode.

- Writeback data rate : D
- Accelerate data ratio : VR4x00 compatible mode

Therefore, set the Config Register as below:

- EP : 0000
- AD : 0

www.DataSheet4U.com

10.4.2 Access Data Size

In the VR4102, access size is restricted for each address space. Access sizes for the following address spaces are listed below.

Table 10-4. Access Size Restrictions for Address Spaces

Address space	R/W	Access size (bytes)						Remark
		16	8	4	3	2	1	
ROM/PageROM	R	○	○	○	○	○	○	
Flash memory	W	×	×	△	×	△	×	Note 1
System bus I/O space	R/W	○	○	○	×	○	○	
System bus memory space	R/W	○	○	○	×	○	○	
On-chip I/O space 1	R/W	○	○	○	×	○	○	
On-chip I/O space 2	R/W	×	○	○	×	○	×	
LCD space	R/W	×	○	○	×	○	○	Notes 2, 3
High-speed system bus memory space	R/W	×	○	○	×	○	○	Note 3
DRAM	R/W	○	○	○	○	○	○	

- Notes 1.** The access size when writing to flash memory must be the same as the data bus width such as below;
 In 32-bit mode: 4 bytes
 In 16-bit mode: 2 bytes
- 2.** Use as uncached.
- 3.** The LCD space and high-speed system bus memory space are mapped to the same physical address.
 Use BCUCNTREG1's ISAM/LCD bit to switch between the two.

Remark ○, △ : accessible, × : not accessible

10.4.3 ROM Interface

(1) Switching among ROM, PageROM, and Flash Memory Modes

The VR4102 supports three modes (ROM, PageROM and Flash Memory). The mode setting in ROM bank 3/2 is set via BCUCNTREG1's ROMWEN2 and PAGEROM2 bits, and the mode setting in ROM bank 1/0 is set via the ROMWEN0 and PAGEROM0 bits. In Ordinary ROM mode or Flash Memory mode, the VR4102 can access to memories regardless of its mode name. Table 10-5 shows accessible memory types and methods of access in each mode.

Table 10-5. Summary of ROM Modes

Mode	Setting		Access-enabled devices		
	ROMWEN2/0	PAGEROM2/0	Memory read	Flash Memory register read	Flash Memory write
Ordinary ROM	0	0	Ordinary ROM PageROM Flash Memory	N/A	N/A
PageROM	0	1	PageROM	N/A	N/A
Flash Memory	1	don't care	Ordinary ROM PageROM Flash Memory	Flash Memory	Flash Memory

Remark The initial setting is Ordinary ROM mode.

(2) Access Speed Setting

The VR4102 enables the access speed to be changed when operating in Ordinary ROM mode or PageROM mode.

For details, see 10.5.1.

10.4.4 Flash Memory Interface

(1) Notes for Specific Modes

The following two modes are available for flash memory.

- Ordinary ROM mode (memory read only)
- Flash Memory mode (supports memory write and register read)

The following notes apply to these modes.

(a) Notes for Ordinary ROM mode

- Write is prohibited
The WR# pin is not asserted even when a write operation is attempted.
- Flash memory register read is prohibited
The Ordinary ROM mode is the mode in which bus cycles suite for memory read operations are issued. Since the AC characteristics of flash memory are different for register read and memory read operations, accurate data cannot be obtained by reading the flash memory register while in this mode.

(b) Notes for Flash Memory mode

- Be sure to access in double-byte units when writing to flash memory.

(2) Example of write sequence for flash memory

An example of a write sequence for flash memory is shown below.

Caution This example's operations have not been confirmed using an actual system.

- 1 Using GPIO as an output port, apply the flash memory write voltage (V_{PP}).
If the VR4102's on-chip GPIOs cannot be used, set up an external output port and then control the write voltage.
- 2 Set the VR4102 to flash memory mode (Set "1" to the BCUCNTREG's ROMWEN bit).
- 3 Wait until the flash memory write voltage become stable.
- 4 Issue the flash memory write command from the VR4102.
- 5 Write data from the VR4102 to flash memory.
- 6 Wait until the flash memory write completion signal (ry/by) becomes stable.
- 7 Wait until the flash memory write completion signal gives notification of write completion.
After write to flash memory is completed, notification can be obtained by receiving an interrupt from the flash memory write completion signal (ry/by) or by polling the flash memory register.
- 8 Read the flash memory register.
 - If write succeeded, start processing from "9".
 - If write failed, start processing from "12".
- 9 If writing new data to flash memory, start processing from "4".
If write to flash memory is completed, start processing from "10".

- 10 Compare the data written to flash memory with the original data.
 - If the data matches, perform processing at “11”.
 - If the data does not match
 - Start processing from “1” when rewriting.
 - If processing is interrupted, start processing from “11”.
- 11 Reduce the flash memory write voltage (V_{PP}) and end processing after flash memory mode has been canceled.
- 12 Clear any error data in the flash memory register.
 - If writing again
 - If the write voltage is too low, start processing from “1”.
 - In all other cases, start processing from “4”.
 - If processing is completed, perform processing at “11”.

10.4.5 LCD Control Interface

(1) Access Size

Available access sizes for accessing the LCD controller interface are 1 byte, 2 bytes, 4 bytes, and 8 bytes.

(2) Data Inversion

When “0” has been set to the BCUCNTREG1’s ISAM/LCD bit and to BCUCNTREG2’s GMODE bit, the VR4102 inverts the bits in the data being read or written via the LCD controller interface.

Table 10-6. Example of Bit Inversion in Data in VR4102 and at DATA [15:0] Pins

Data in VR4102	Data at DATA [15:0] Pins
0x0000	0xFFFF
0xA5A5	0x5A5A
0x1234	0xEDCB

10.4.6 Illegal Access Notification

(1) Types of Illegal Access

Under the following circumstances, the VR4102 provides notification concerning illegal access of the CPU core.

- **Bus deadlock**

If CBR refresh does not occur at least twice, a deadlock is judged as having occurred due to the non-return of a ready signal via the system bus or LCD controller interface, in which case notification of illegal access is given.

- **Address space reserved for future use**

Notification of illegal access is given when the processor has accessed any of the following addresses.

0x0FFF FFFF to 0x0C00 0000

0x09FF FFFF to 0x0400 0000

(2) Notification Method for Illegal Access

The methods used to notify the CPU core are listed below.

Table 10-7. Illegal Access Notification Methods

Access type	Illegal access notification method
Processor read request	Notification by bus error caused by SysCmd
Processor write request	Notification by interrupt exception (Int0)

Remark To clear the interrupt source caused by a processor write request, write “1” to BCUERRSTREG's bit1.

10.5 BUS OPERATIONS

The bus operations of buses controlled by the BCU are described below.
The BCU's operating clock (TClock) appears in the timing chart for each bus operation.

Remark # that follows signal names indicates active low.

10.5.1 ROM Access

The VR4102 supports the following three modes for ROM access.
Use BCUCNTREG1's PAGEROM2/0 bits and ROMWEN2/0 bits to set the mode.

- Ordinary ROM read mode (ROMWEN, PAGEROM = 00)
- PageROM read mode (ROMWEN, PAGEROM = 01)
- Flash Memory mode (ROMWEN = 1)

(1) Ordinary ROM Read Mode

Set ROMWEN = 0 and PAGEROM = 0.

WROMA[2:0] (BCUSPEEDREG [2:0]) can be used to set the access time.

Figures 10-1 and 10-2 show 4-byte read timing chart data for when WROMA [2:0] is set to "110". If access uses a data size larger than 4 bytes, the T_{rom} cycle is continued until the required access size is reached.

Table 10-8. Access Times during Ordinary ROM Read Mode

WROMA [2:0]	T _{rom} (TClock)
000	9
001	8
010	7
011	6
100	5
101	4
110	3
111	2

Figure 10-1. ROM 4-byte Read, 16-bit Mode (WROMA[2:0] = 110)

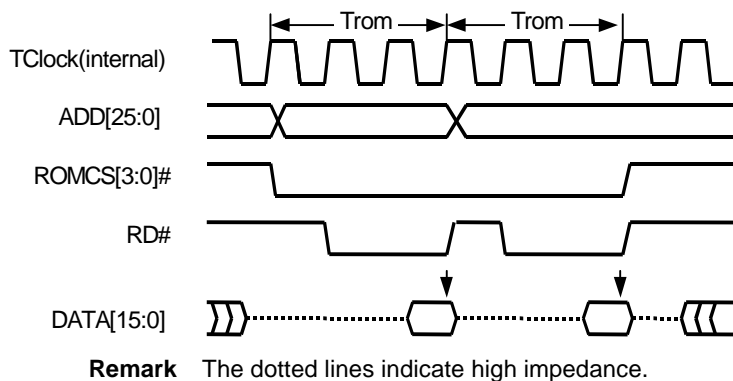
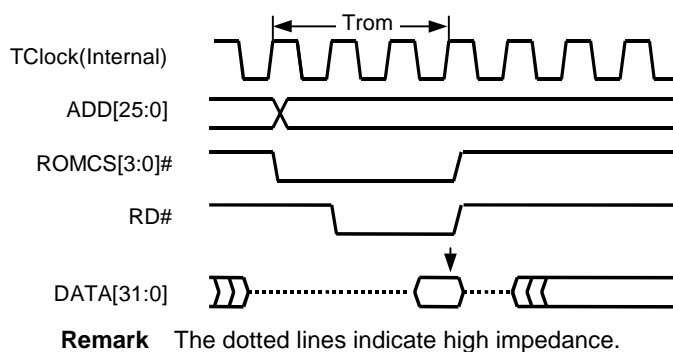

Figure 10-2. ROM 4-byte Read, 32-bit Mode (WROMA[2:0] = 110)



Data is sampled at the rising edge of the TClock following the last Trom-state TClock.
The bus operation types for ordinary ROM are as follows.

1-byte read, 2-byte read, 3-byte read, 1-word read, 2-word read, and 4-word read (1 word = 4 bytes)

(2) PageROM Read Mode

Set ROMWEN = 0 and PAGEROM = 1.

WROMA[2:0] (BCUSPEEDREG [2:0]) and WPROM[1:0] (BCUSPEEDREG [13:12]) can be used to set the access time.

Figures 10-3 and 10-4 show 16-byte read timing charts for when WROMA [2:0] is set to “111” and WPROM [1:0] is set to “10”. The ROMCS[3:0]# and RD# pins are held at low level during Trom cycles.

Table 10-9. PageROM Read Mode Access Time

WROMA [2:0]	Trom (TClock)	WPROM [1:0]	Tprom (TClock)
000	9	00	3
001	8	01	2
010	7	10	1
011	6	11	RFU
100	5		
101	4		
110	3		
111	2		

www.DataSheet4U.com

Figure 10-3. PageROM 4-word Read, 16-bit Mode (WROMA[2:0] = 111, WPROM[1:0] = 10)

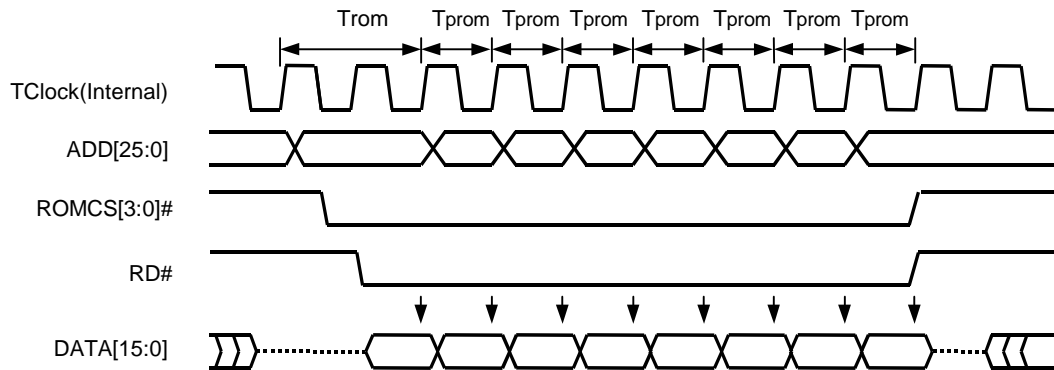

Remark The dotted lines indicate high impedance.

Figure 10-4. PageROM 4-word Read, 32-bit Mode (WROMA[2:0] = 111, WPROM[1:0] = 10)

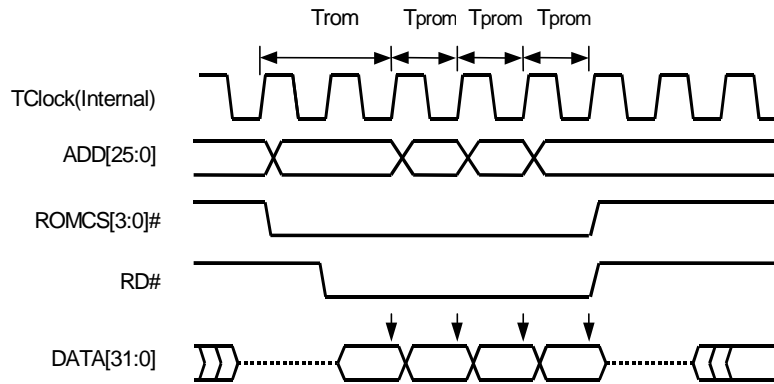

Remark The dotted lines indicate high impedance.

(3) Flash Memory Mode

Set ROMWEN = 1.

This mode is used to meet the electrical characteristics required for writing to flash memory and for accessing the flash register. This mode can also be used to read to flash memory.

Note that the access time is constant when in this mode.

Figure 10-5. Flash Memory Mode, 2-byte Access

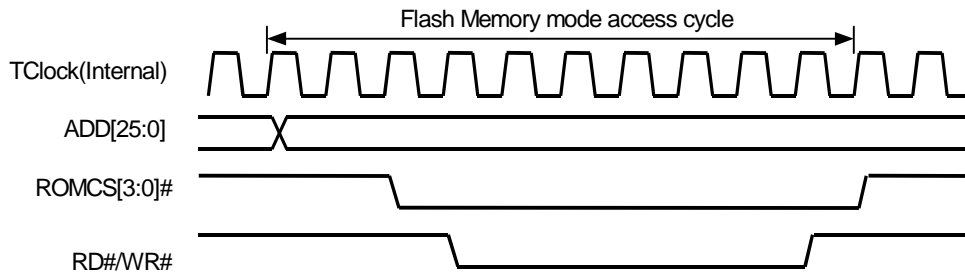

10.5.2 System Bus Access

(1) Bus Operations in System Bus

WISAA[2:0] (BCUSPEEDREG [6:4]) can be used to set the access time.

Table 10-10. System Bus Access Times

WISAA [2:0]	Tisa (TClock)
000	8
001	7
010	6
011	5
100	4
101	3
110	RFU
111	RFU

www.DataSheet4U.com

Figure 10-6. 1-byte Access to Even Address Using 16-bit Bus (WISAA[2:0] = 101)

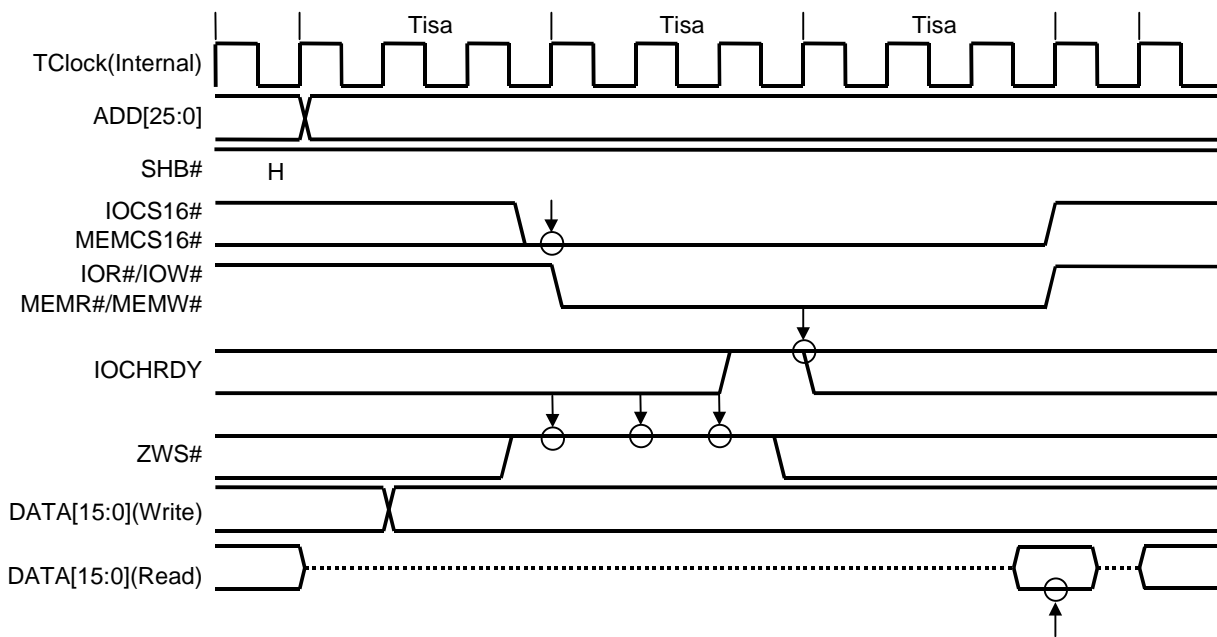

Remark The dotted lines indicate high impedance.

Figure 10-7 illustrates 2-byte access when sampling IOCHRDY at high level. If the system bus access time has been set as three TClocks (WISAA[2:0] = 101), the bus cycle will end after waiting for at least 3 TClocks (Tisa periods) after the ready signal is sampled using IOCHRDY.

Sampling of the IOCHRDY signal occurs at the rising edge of the TClock that follows the second or subsequent Tisa period.

Figure 10-7. 2-byte Access when Sampling IOCHRDY at High Level Using 16-bit Bus (WISAA[2:0] = 101)

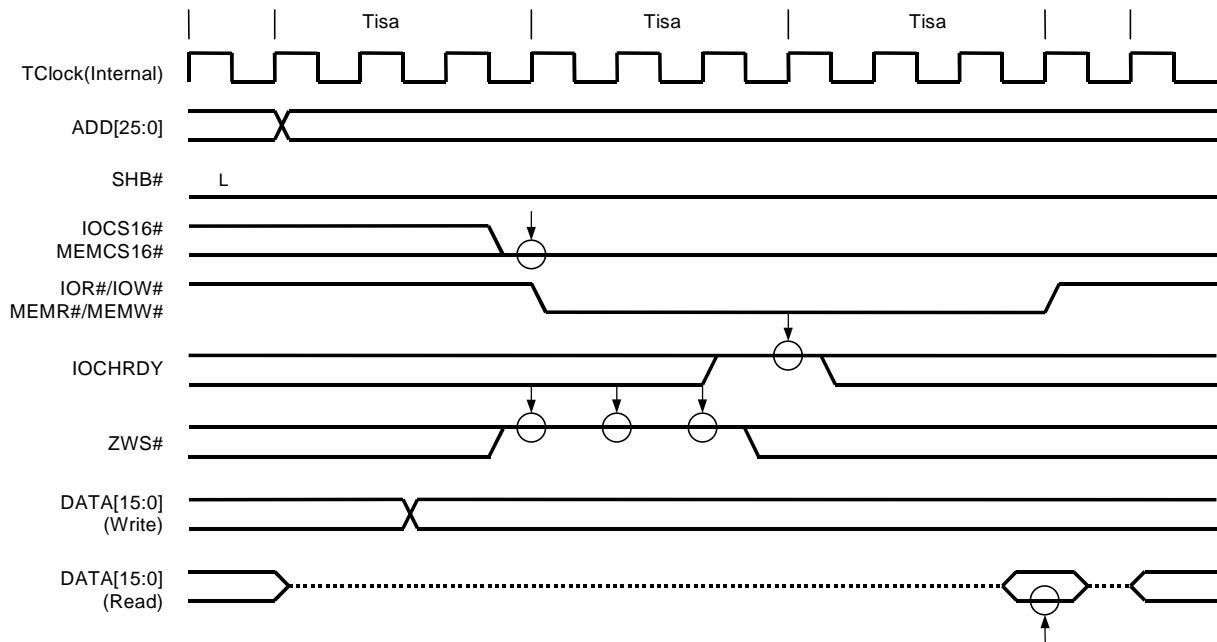

Remark The dotted lines indicate high impedance.

Figures 10-8 and 10-9 show timing charts for 1-byte access.

Figure 10-8. 1-byte Access to Odd Address Using 16-bit Bus (WISAA[2:0] = 101)

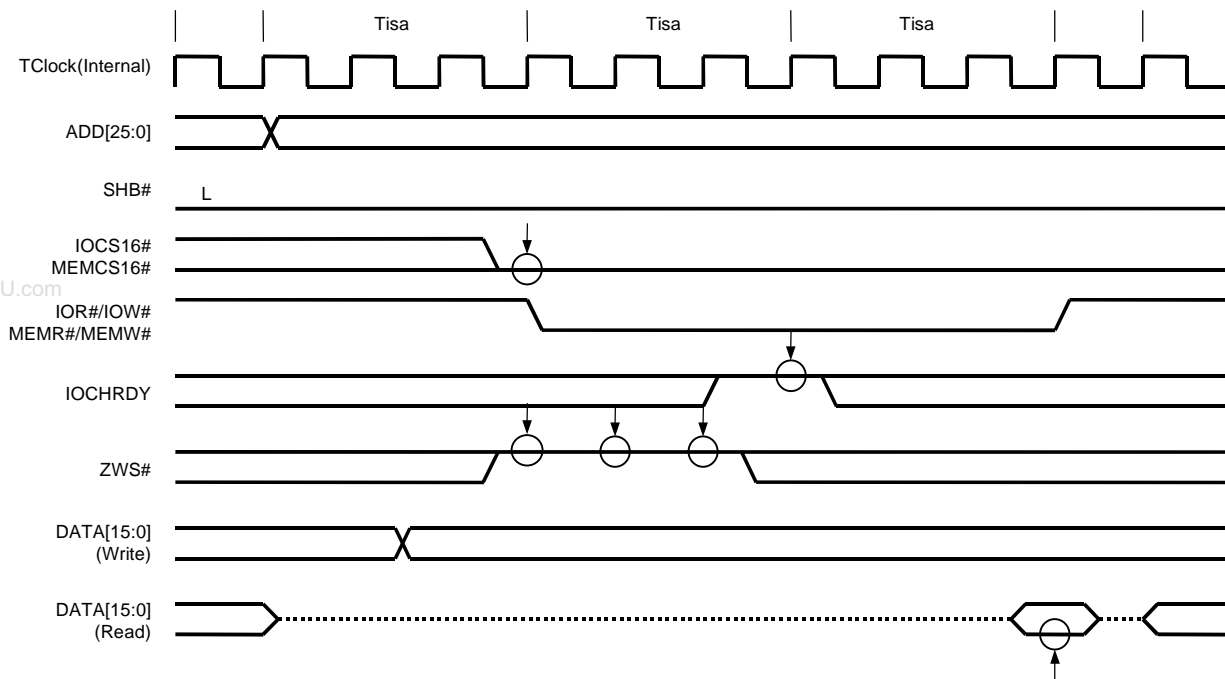

Remark The dotted lines indicate high impedance.

Figure 10-9. 1-byte Access to Odd Address Using 8-bit Bus (WISAA[2:0] = 101)

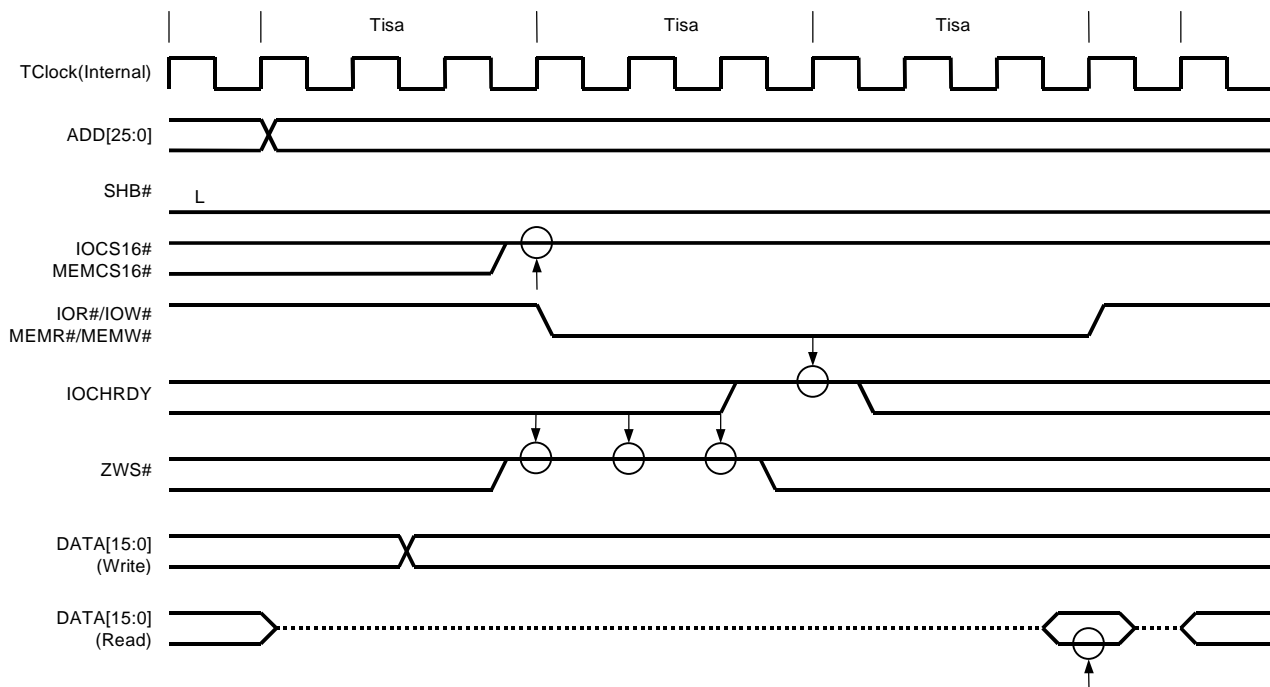

Remark The dotted lines indicate high impedance.

Figures 10-10 and 10-11 illustrate 2-byte access when sampling ZWS# at low level. The bus cycle will end after waiting for at least 1 TClock (Tisa period) after the ready signal is sampled using ZWS#.

Sampling of the ZWS# signal occurs at the rising edge of the TClock that follows the second or subsequent Tisa period.

Figure 10-10. 2-byte Access when Sampling ZWS# at Low Level on 16-bit Bus (WISAA[2:0] = 101)

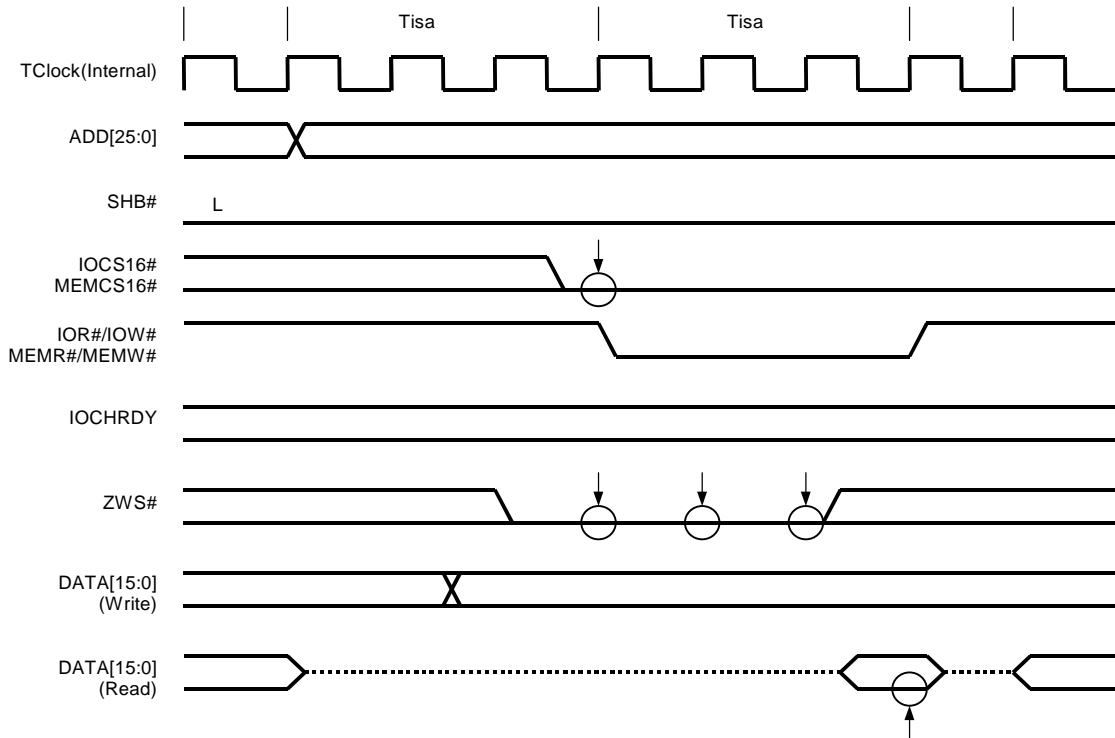

Remark The dotted lines indicate high impedance.

Figure 10-11. 2-byte Access when Sampling ZWS# at Low Level on 8-bit Bus (WISAA[2:0] = 101)

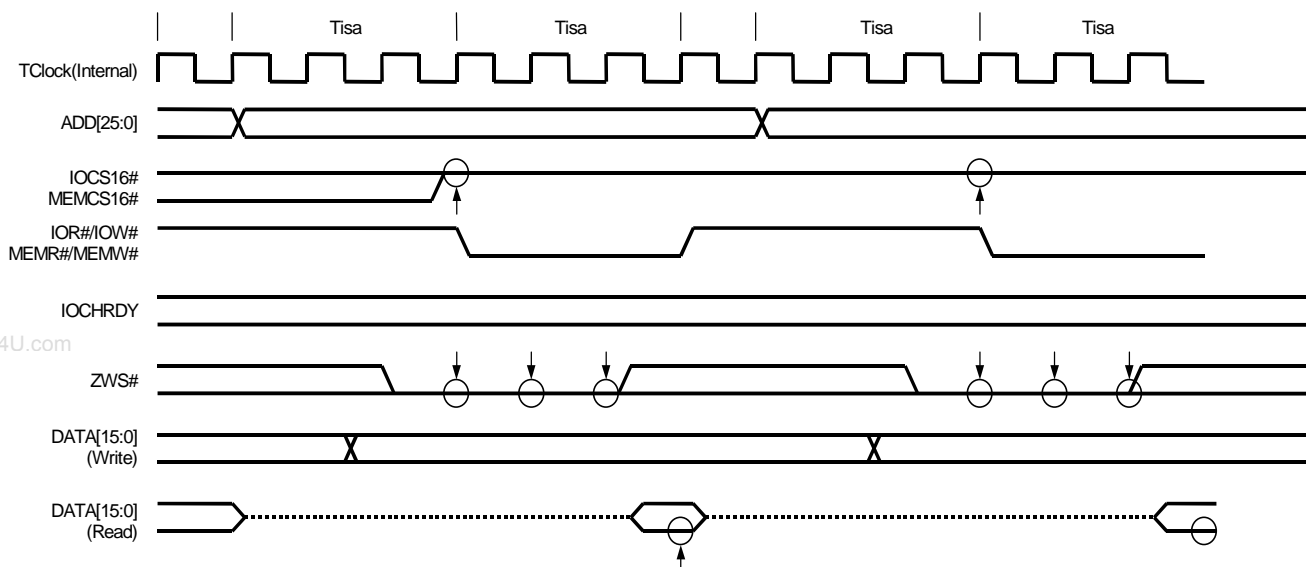

Remark The dotted lines indicate high impedance.

(2) Bus Operations in High-Speed System Bus

The space of physical address from 0x0A00 0000 to 0x0AFF FFFF can be used as the high-speed system bus memory space by setting the ISAM/LCD bit of BCUCNTREG1. WLCD/M [2:0] (BCUSPEEDREG [10:8]) can be used to set the access time for access to this space, as shown in the table below.

Table 10-11. High-Speed System Bus Access Times

WLCD/W [2:0]	Tisa (TClock)
000	8
001	7
010	6
011	5
100	4
101	3
110	2
111	1

Figure 10-12. 2-byte Access on 16-bit Bus (WLCD/M[2:0] = 101)

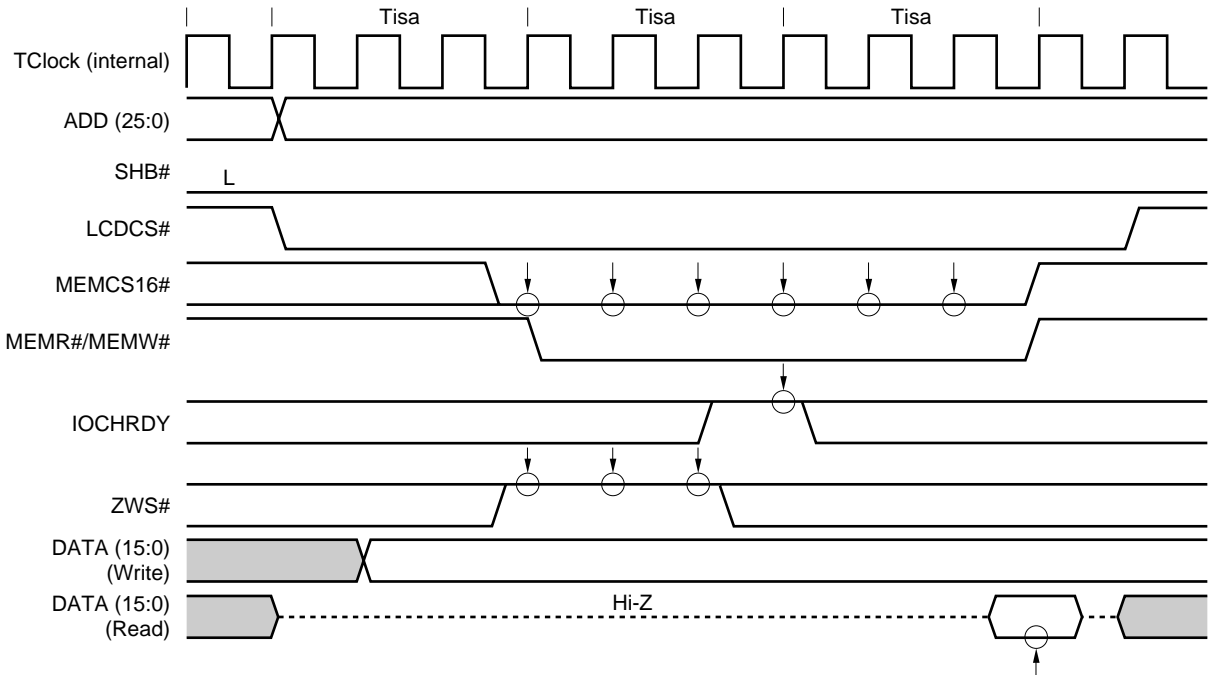

Figure 10-13. 1-byte Access on 8-bit Bus (WLCD/M[2:0] = 101)

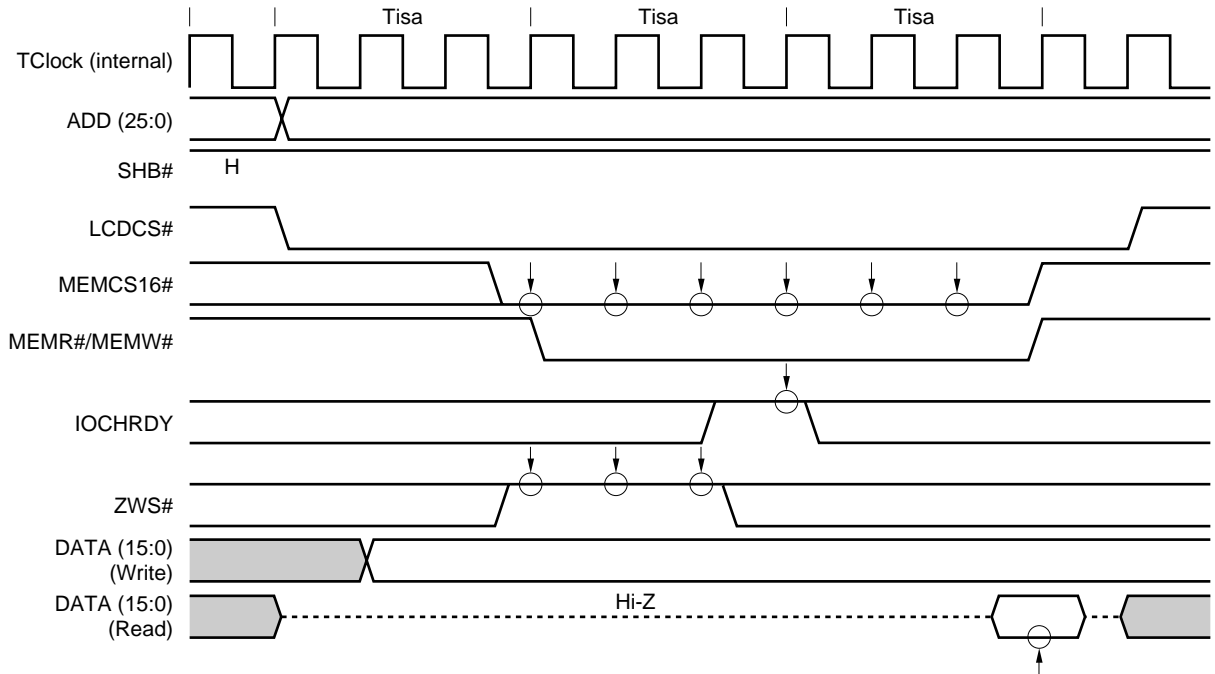

Figure 10-14. 2-byte Access when Sampling ZWS# at Low Level on 16-bit Bus (WLCD/M[2:0] = 101)

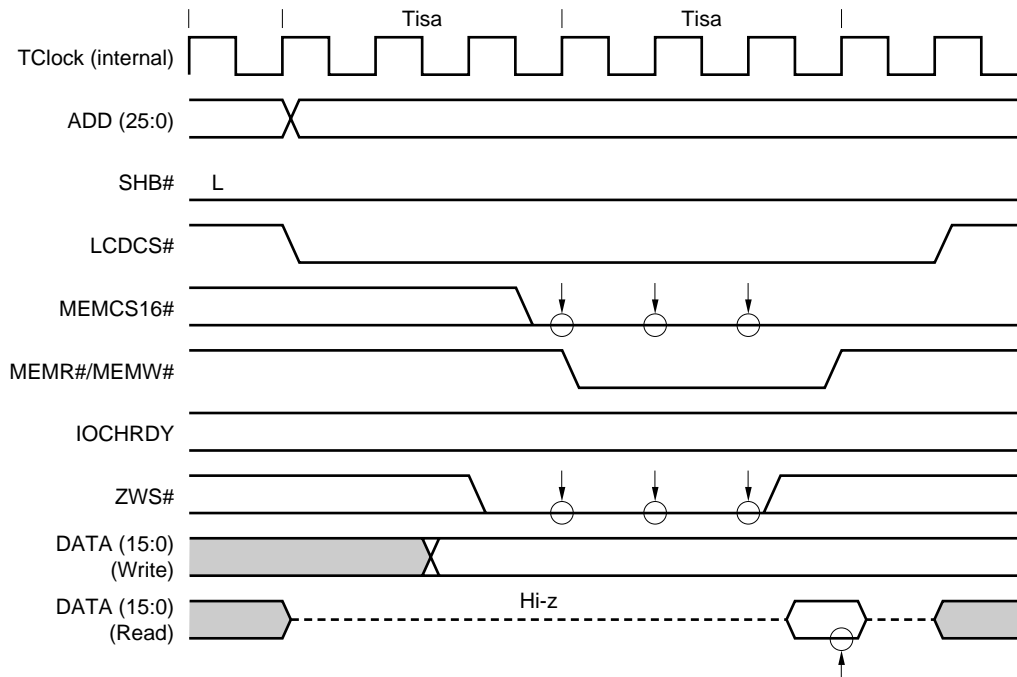
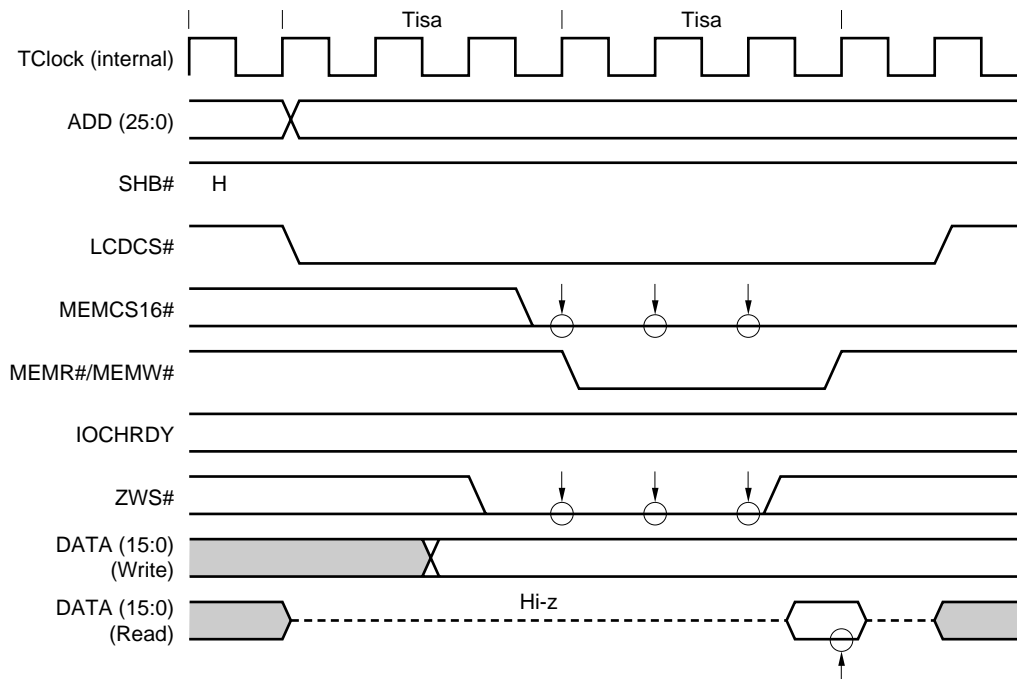

Figure 10-15. 1-byte Access when Sampling ZWS# at Low Level on 8-bit Bus (WLCD/M[2:0] = 101)



10.5.3 LCD Interface

The space of the physical address, from 0x0A00 0000 to 0x0AFF FFFF can be used as the LCD space by setting the ISM/LCD bit of the BCUCNTREG1. WLCD/M[2:0] (BCUSPEEDREG [10:8]) can be used to set the access time.

Table 10-12. Access Times for LCD Interface

WLCD/M [2:0]	Tlcd (TClock)
000	8
001	6
010	4
011	2
100 - 111	RFU

www.DataSheet4U.com

Figure 10-16. 2-byte Access to LCD Controller (WLCD/M[2:0] = 010)

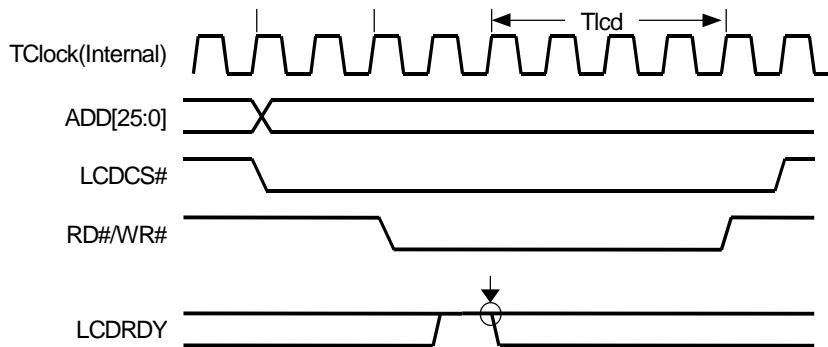
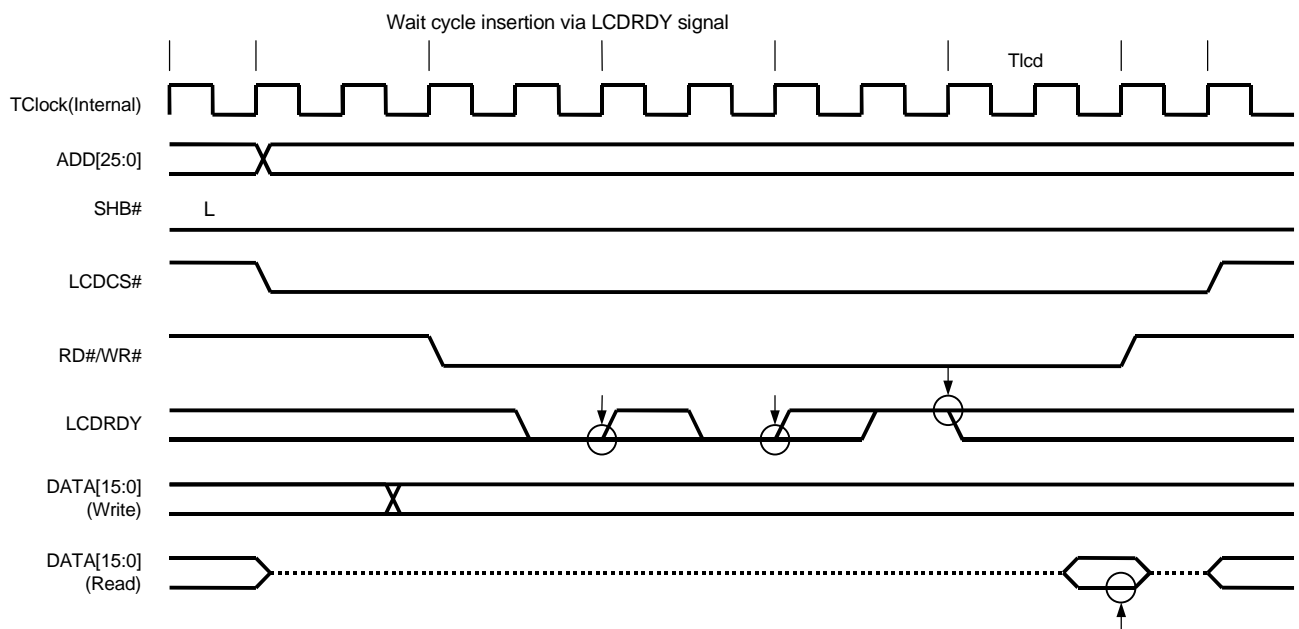

Figure 10-17. 2-byte Access to LCD Controller (WLCD/M[2:0] = 011)



Remark The dotted lines indicate high impedance.

10.5.4 DRAM Access (EDO Type)

The access time is constant for DRAM.

Figure 10-18. 4-byte Access to DRAM (16-bit Mode)

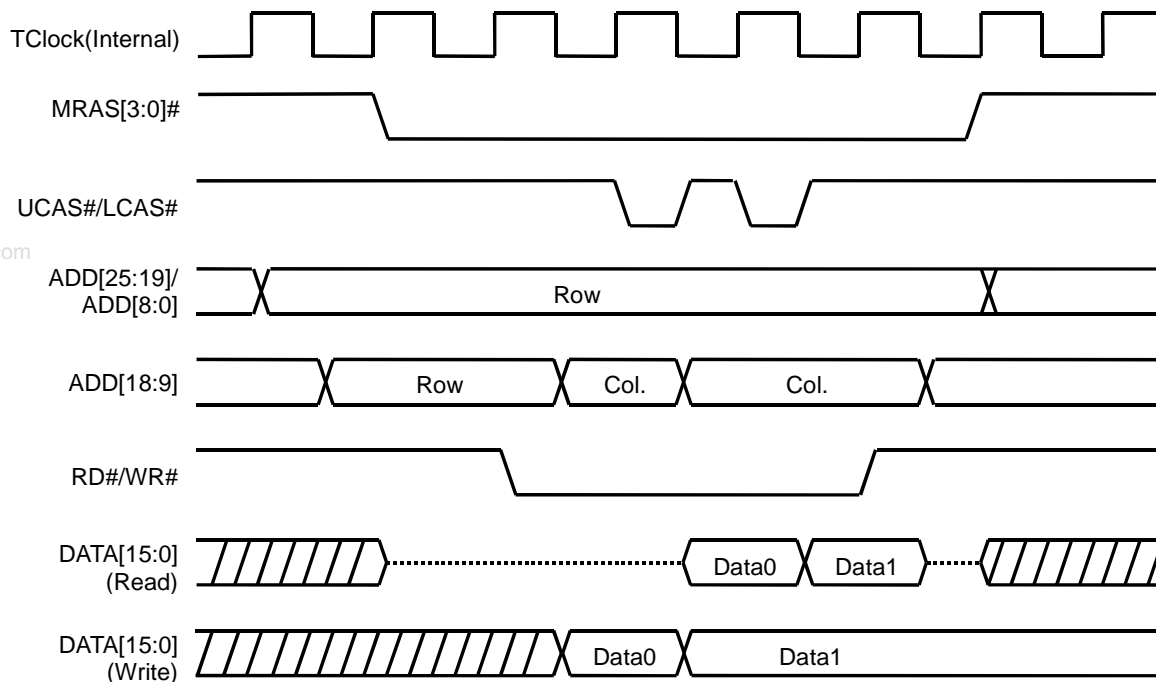

Remark The dotted lines indicate high impedance.

Figure 10-19. 8-byte Access to DRAM (32-bit Mode)

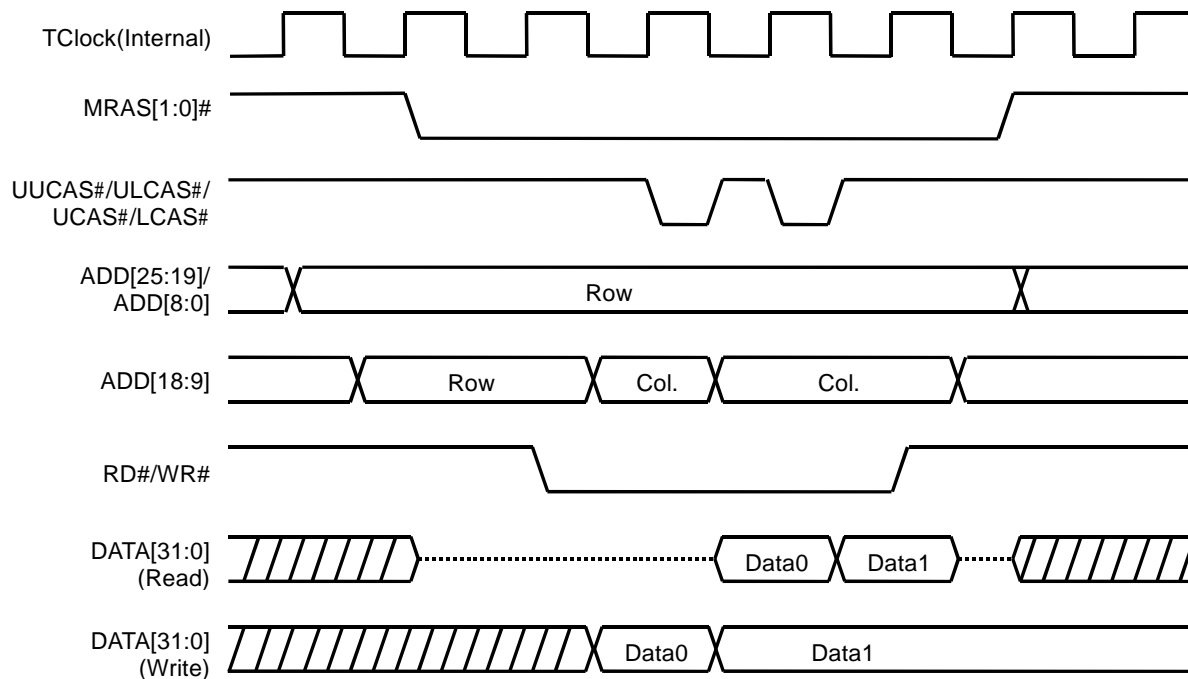

Remark The dotted lines indicate high impedance.

Figure 10-20. Byte Read of Odd Address in DRAM (16-bit Mode)

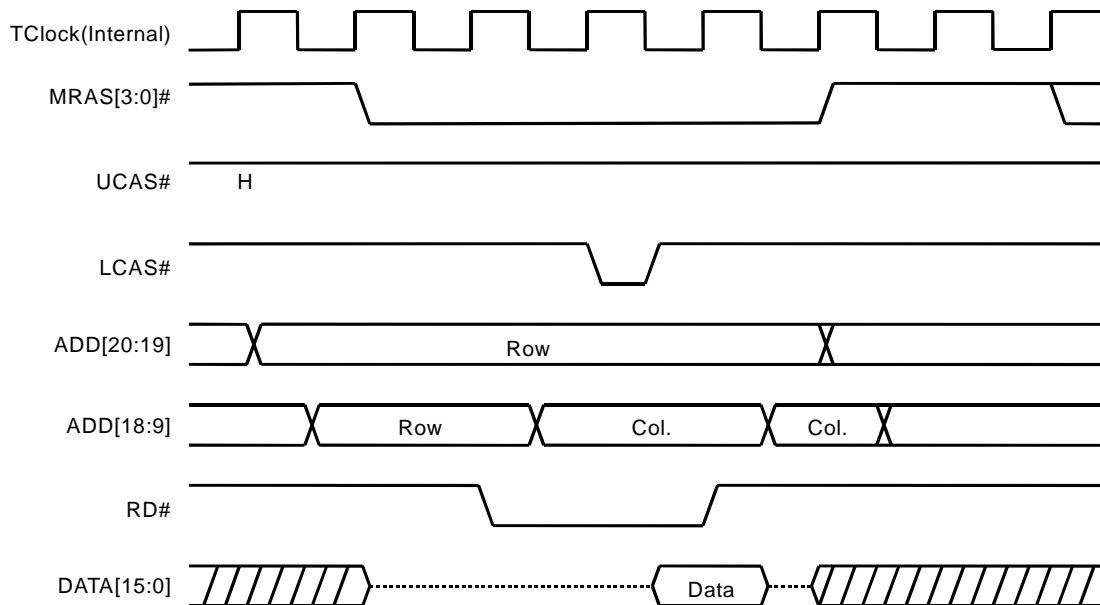

Remark The dotted lines indicate high impedance.

Figure 10-21. Byte Read of Even Address in DRAM (16-bit Mode)

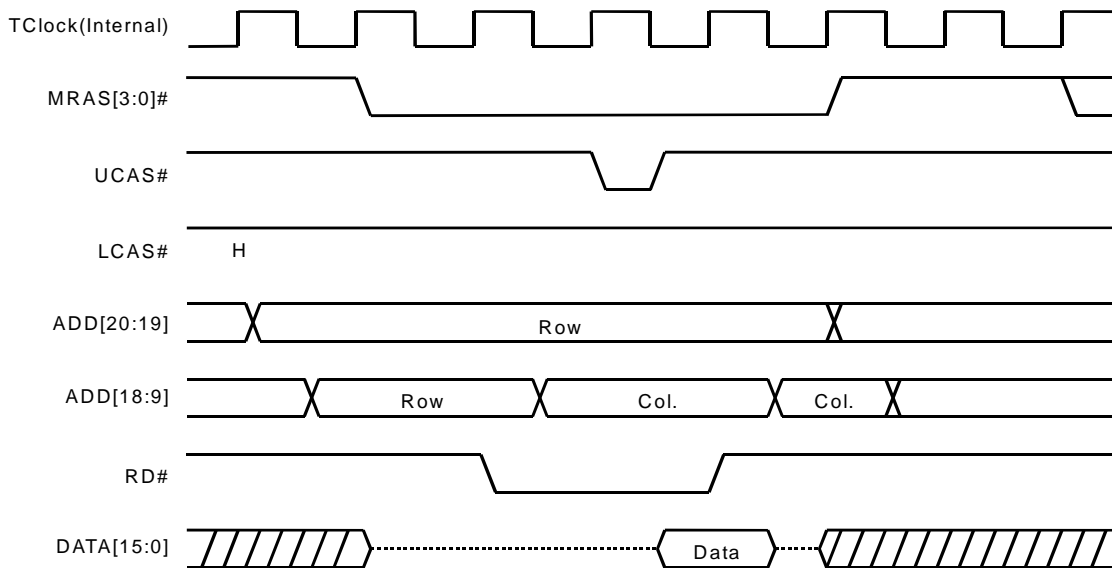

Remark The dotted lines indicate high impedance.

Figure 10-22. Byte Write to Odd Address in DRAM (16-bit Mode)

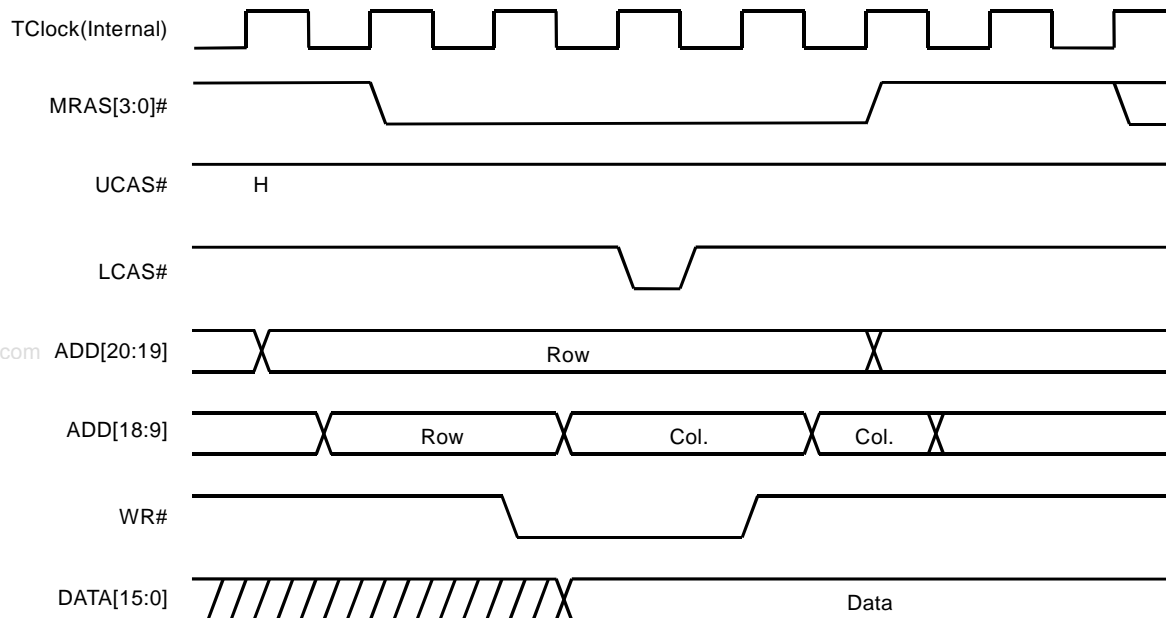
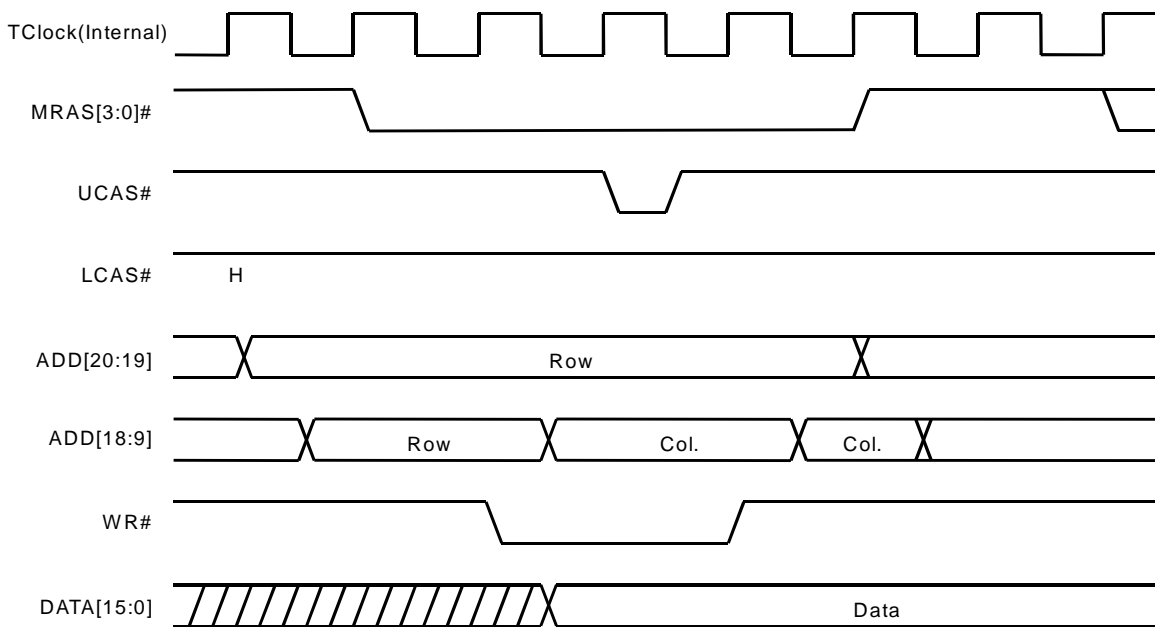

Figure 10-23. Byte Write to Even Address in DRAM (16-bit Mode)



10.5.5 Refresh

The VR4102 supports CBR refresh and self refresh.

(1) CBR Refresh

Figure 10-24. CBR Refresh (16-bit Mode)

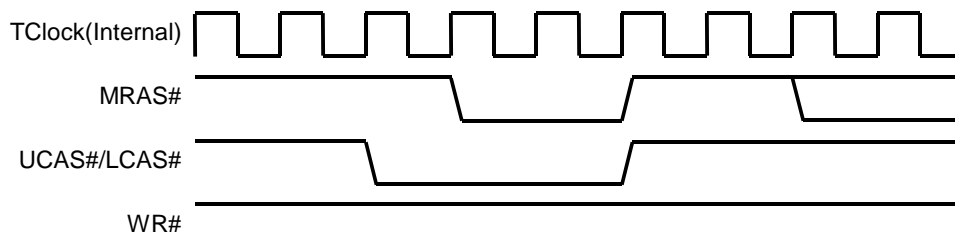

www.DataSheet4U.com

(2) Self Refresh

Figure 10-25. Self Refresh (16-bit Mode)

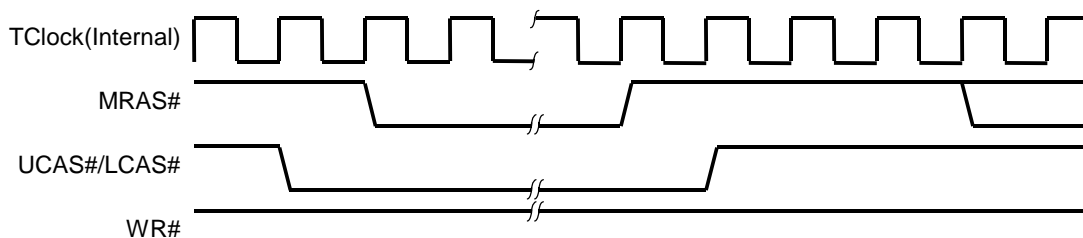

10.5.6 Bus Hold

Caution The BUSCLK signal is fixed at low level during execution of the SUSPEND instruction. Consequently, while the SUSPEND instruction is being executed, the bus is being used by an external master device and cannot be used for BUSCLK.

Figure 10-26. Bus Hold in Fullspeed Mode

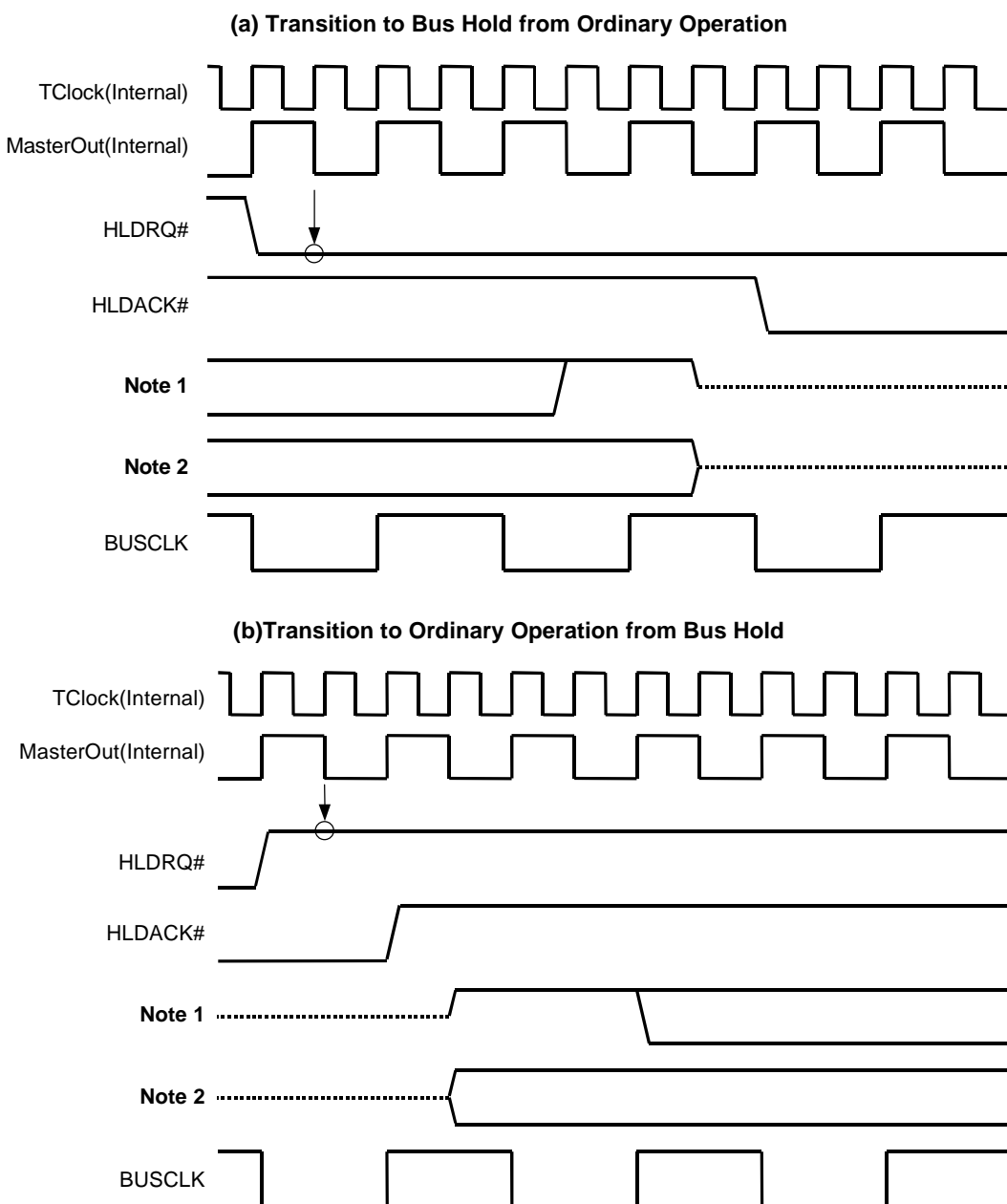

- Notes**
1. UUCAS#/MRAS[3]#, ULCAS#/MRAS[2]#, MRAS[1..0]#, UCAS#, LCAS#
 2. SHB#, IOR#, IOW#, MEMR#, MEMW#, RD#, WR#, ADD[25..0], DATA[15..0], DATA[31..16]/GPIO[31..16] (in 32-bit data bus mode)

Remark The dotted lines indicate high impedance.

Figure 10-27. Bus Hold in Suspend Mode

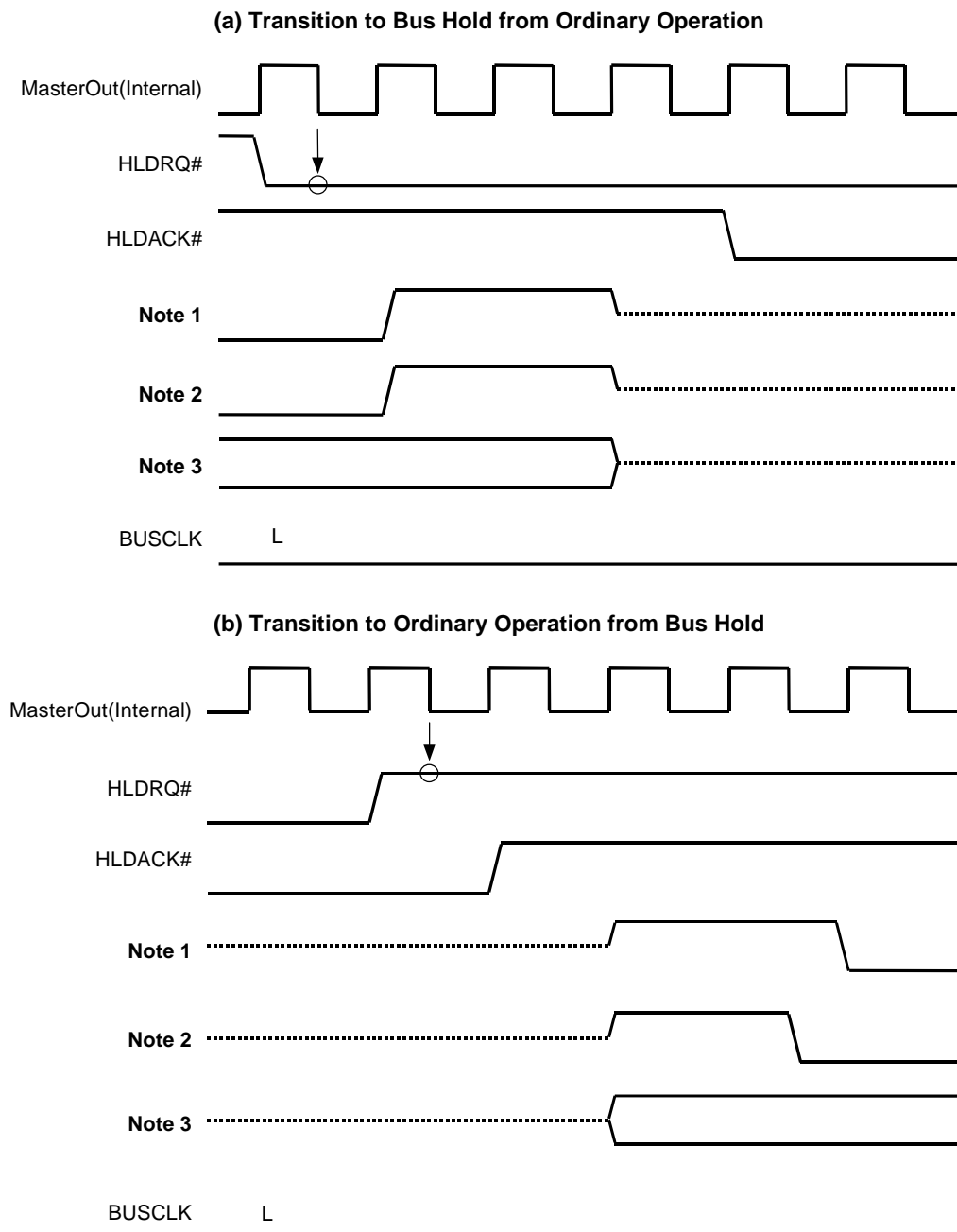

- Notes**
1. UUCAS#/MRAS[3]#, ULCAS#/MRAS[2]#, MRAS[1..0]# (in 16-bit data bus mode)
MRAS[1..0]# (in 32-bit data bus mode)
 2. UCAS#, LCAS# (in 16-bit data bus mode)
UUCAS#/MRAS#[3], ULCAS#/MRAS[2]#, UCAS#, LCAS# (in 32-bit data bus mode)
 3. SHB#, IOR#, IOW#, MEMR#, MEMW#, RD#, WR#, ADD[25..0], DATA[15..0],
DATA[31..16]/GPIO[31..16] (in 32-bit data bus mode)

Remark The dotted lines indicate high impedance.

[MEMO]

CHAPTER 11 DMAAU (DMA ADDRESS UNIT)

This chapter describes the DMAAU register's operations and settings.

11.1 GENERAL

The DMAAU register controls the DMA addresses for the AIU and IrDA 4-Mbps communication module (FIR).

The DMA channel used for each unit can set a DMA start address as any half-word address in the space from 0x0000 0000 to 0x01FF FFFE, and is retained in DRAM as a 2-Kbyte block that starts at the address which is generated by masking the low-order 10 bits of the DMA start address.

After a DMA start address is set to the DMA base address register, the VR4102 performs DMA transfer using the registers of DMAAU as below.

(1) When the DMA start address is included in the first page of the DMA space

1. The VR4102 starts a DMA transfer after writing the start address to the DMA address register.
2. When the DMA transfer reaches the first page boundary, the VR4102 adds 1 Kbyte to the contents of the DMA base address register, writes the value to the DMA address register, and continues the DMA transfer.
3. When the DMA transfer reaches the second page boundary, the VR4102 writes the contents of the DMA base address register to the DMA address register and continues the DMA transfer.
4. The VR4102 repeats 2. and 3. until all the data is transferred.

(2) When the DMA start address is included in the second page of the DMA space

1. The VR4102 starts a DMA transfer after writing the start address to the DMA address register.
2. When the DMA transfer reaches the second page boundary, the VR4102 subtracts 1 Kbyte from the contents of the DMA base address register, writes the value to the DMA address register, and continues the DMA transfer.
3. When the DMA transfer reaches the first page boundary, the VR4102 writes the contents of the DMA base address register to the DMA address register and continues the DMA transfer.
4. The VR4102 repeats 2. and 3. until all the data is transferred.

Figure 11-1. DMA Space Used in DMA Transfers

(a) When the DMA start address is included in the first page of the DMA space

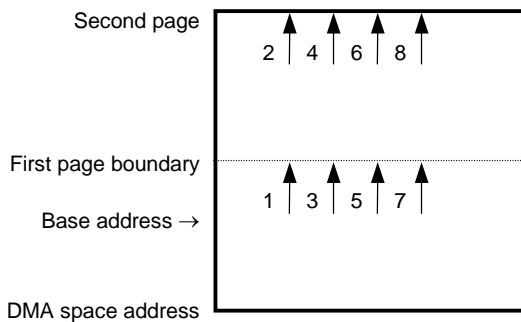

(b) When the DMA start address is included in the second page of the DMA space

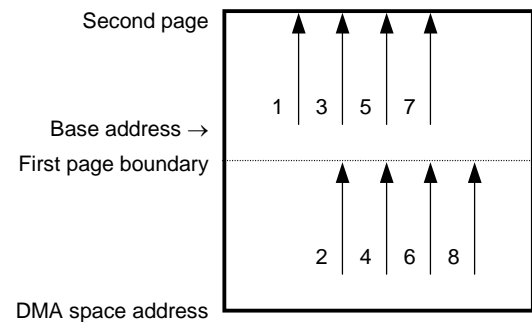

Caution DMA operations are not guaranteed if an address overlaps with another DMA buffer.

11.2 REGISTER SET

The DMAAU registers are listed below.

Table 11-1. DMAAU Registers

Address	R/W	Register Symbols	Function
0x0B00 0020	R/W	AIUIBALREG	AIU IN DMA Base Address Register Low
0x0B00 0022	R/W	AIUIBAHREG	AIU IN DMA Base Address Register High
0x0B00 0024	R/W	AIUIALREG	AIU IN DMA Address Register Low
0x0B00 0026	R/W	AIUIAHREG	AIU IN DMA Address Register High
0x0B00 0028	R/W	AIUOBALREG	AIU OUT DMA Base Address Register Low
0x0B00 002A	R/W	AIUOBHREG	AIU OUT DMA Base Address Register High
0x0B00 002C	R/W	AIUOALREG	AIU OUT DMA Address Register Low
0x0B00 002E	R/W	AIUOAHREG	AIU OUT DMA Address Register High
0x0B00 0030	R/W	FIRBALREG	FIR DMA Base Address Register Low
0x0B00 0032	R/W	FIRBAHREG	FIR DMA Base Address Register High
0x0B00 0034	R/W	FIRALREG	FIR DMA Address Register Low
0x0B00 0036	R/W	FIRAHREG	FIR DMA Address Register High

These registers are described in detail below.

11.2.1 AIU IN DMA Base Address Registers

(1) AIUIBALREG (0x0B00 0020)

Bit	D15	D14	D13	D12	D11	D10	D9	D8
Name	AIUIBA[15]	AIUIBA[14]	AIUIBA[13]	AIUIBA[12]	AIUIBA[11]	AIUIBA[10]	AIUIBA[9]	AIUIBA[8]
R/W	R/W	R/W	R/W	R/W	R/W	R/W	R/W	R/W
RTCRST	1	1	1	1	1	0	0	0
Other resets	1	1	1	1	1	0	0	0

Bit	D7	D6	D5	D4	D3	D2	D1	D0
Name	AIUIBA[7]	AIUIBA[6]	AIUIBA[5]	AIUIBA[4]	AIUIBA[3]	AIUIBA[2]	AIUIBA[1]	AIUIBA[0]
R/W	R/W	R/W	R/W	R/W	R/W	R/W	R/W	R
RTCRST	0	0	0	0	0	0	0	0
Other resets	0	0	0	0	0	0	0	0

Bit	Name	Function
D[15:1]	AIUIBA[15:1]	DMA base address [15:1] for AIU input
D[0]	AIUIBA[0]	DMA base address [0] for AIU input Write 0 when writing. 0 is returned after a read.

(2) AIUIBAHREG (0x0B00 0022)

Bit	D15	D14	D13	D12	D11	D10	D9	D8
Name	AIUIBA[31]	AIUIBA[30]	AIUIBA[29]	AIUIBA[28]	AIUIBA[27]	AIUIBA[26]	AIUIBA[25]	AIUIBA[24]
R/W	R	R	R	R	R	R	R	R/W
RTCRST	0	0	0	0	0	0	0	1
Other resets	0	0	0	0	0	0	0	1

Bit	D7	D6	D5	D4	D3	D2	D1	D0
Name	AIUIBA[23]	AIUIBA[22]	AIUIBA[21]	AIUIBA[20]	AIUIBA[19]	AIUIBA[18]	AIUIBA[17]	AIUIBA[16]
R/W	R/W	R/W	R/W	R/W	R/W	R/W	R/W	R/W
RTCRST	1	1	1	1	1	1	1	1
Other resets	1	1	1	1	1	1	1	1

Bit	Name	Function
D[15:9]	AIUIBA[31:25]	DMA base address [31:25] for AIU input Write 0 when writing. 0 is returned after a read.
D[8:0]	AIUIBA[24:16]	DMA base address [24:16] for AIU input

AIUIBALREG and AIUIBAHREG are used to set the base addresses for the DMA channel used for audio input (recording).

The addresses set to this register become DMA start addresses.

The DMA channel used for audio input is retained in DRAM as a 2-Kbyte buffer that starts at the address which is generated by masking the low-order 10 bits of the DMA start address.

11.2.2 AIU IN DMA Address Registers

(1) AIUIALREG (0x0B00 0024)

Bit	D15	D14	D13	D12	D11	D10	D9	D8
Name	AIUIA[15]	AIUIA[14]	AIUIA[13]	AIUIA[12]	AIUIA[11]	AIUIA[10]	AIUIA[9]	AIUIA[8]
R/W	R/W	R/W	R/W	R/W	R/W	R/W	R/W	R/W
RTCRST	1	1	1	1	1	0	0	0
Other resets	1	1	1	1	1	0	0	0

Bit	D7	D6	D5	D4	D3	D2	D1	D0
Name	AIUIA[7]	AIUIA[6]	AIUIA[5]	AIUIA[4]	AIUIA[3]	AIUIA[2]	AIUIA[1]	AIUIA[0]
R/W	R/W	R/W	R/W	R/W	R/W	R/W	R/W	R/W
RTCRST	0	0	0	0	0	0	0	0
Other resets	0	0	0	0	0	0	0	0

Bit	Name	Function
D[15:0]	AIUIA[15:0]	Next DMA address [15:0] to be accessed for AIU input channel

(2) AIUIAHREG (0x0B00 0026)

Bit	D15	D14	D13	D12	D11	D10	D9	D8
Name	AIUIA[31]	AIUIA[30]	AIUIA[29]	AIUIA[28]	AIUIA[27]	AIUIA[26]	AIUIA[25]	AIUIA[24]
R/W	R	R	R	R	R	R	R	R/W
RTCRST	0	0	0	0	0	0	0	1
Other resets	0	0	0	0	0	0	0	1

Bit	D7	D6	D5	D4	D3	D2	D1	D0
Name	AIUIA[23]	AIUIA[22]	AIUIA[21]	AIUIA[20]	AIUIA[19]	AIUIA[18]	AIUIA[17]	AIUIA[16]
R/W	R/W	R/W	R/W	R/W	R/W	R/W	R/W	R/W
RTCRST	1	1	1	1	1	1	1	1
Other resets	1	1	1	1	1	1	1	1

Bit	Name	Function
D[15:0]	AIUIA[31:16]	Next DMA address [31:16] to be accessed for AIU input channel

11.2.3 AIU OUT DMA Base Address Registers

(1) AIUOBALREG (0x0B00 0028)

Bit	D15	D14	D13	D12	D11	D10	D9	D8
Name	AIUOBA[15]	AIUOBA[14]	AIUOBA[13]	AIUOBA[12]	AIUOBA[11]	AIUOBA[10]	AIUOBA[9]	AIUOBA[8]
R/W	R/W	R/W	R/W	R/W	R/W	R/W	R/W	R/W
RTCRST	1	1	1	1	1	0	0	0
Other resets	1	1	1	1	1	0	0	0

Bit	D7	D6	D5	D4	D3	D2	D1	D0
Name	AIUOBA[7]	AIUOBA[6]	AIUOBA[5]	AIUOBA[4]	AIUOBA[3]	AIUOBA[2]	AIUOBA[1]	AIUOBA[0]
R/W	R/W	R/W	R/W	R/W	R/W	R/W	R/W	R
RTCRST	0	0	0	0	0	0	0	0
Other resets	0	0	0	0	0	0	0	0

Bit	Name	Function
D[15:1]	AIUOBA[15:1]	DMA base address [15:1] for AIU output
D[0]	AIUOBA[0]	DMA base address [0] for AIU output Write 0 when writing. 0 is returned after a read.

(2) AIUOBAREG (0x0B00 002A)

Bit	D15	D14	D13	D12	D11	D10	D9	D8
Name	AIUOBA[31]	AIUOBA[30]	AIUOBA[29]	AIUOBA[28]	AIUOBA[27]	AIUOBA[26]	AIUOBA[25]	AIUOBA[24]
R/W	R	R	R	R	R	R	R	R/W
RTCRST	0	0	0	0	0	0	0	1
Other resets	0	0	0	0	0	0	0	1

Bit	D7	D6	D5	D4	D3	D2	D1	D0
Name	AIUOBA[23]	AIUOBA[22]	AIUOBA[21]	AIUOBA[20]	AIUOBA[19]	AIUOBA[18]	AIUOBA[17]	AIUOBA[16]
R/W	R/W	R/W	R/W	R/W	R/W	R/W	R/W	R/W
RTCRST	1	1	1	1	1	1	1	1
Other resets	1	1	1	1	1	1	1	1

Bit	Name	Function
D[15:9]	AIUOBA[31:25]	DMA base address [31:25] for AIU output Write 0 when writing. 0 is returned after a read.
D[8:0]	AIUOBA[24:16]	DMA base address [24:16] for AIU output

AIUOBALREG and AIUOBAREG are used to set the base addresses for the DMA channel used for audio output (playback).

The addresses set to this register become DMA start addresses.

The DMA channel used for audio output is retained in DRAM as a 2-Kbyte buffer that starts at the address which is generated by masking the low-order 10 bits of the DMA start address.

11.2.4 AIU OUT DMA Address Registers

(1) AIUOALREG (0x0B00 002C)

Bit	D15	D14	D13	D12	D11	D10	D9	D8
Name	AIUOA[15]	AIUOA[14]	AIUOA[13]	AIUOA[12]	AIUOA[11]	AIUOA[10]	AIUOA[9]	AIUOA[8]
R/W	R/W	R/W	R/W	R/W	R/W	R/W	R/W	R/W
RTCRST	1	1	1	1	1	0	0	0
Other resets	1	1	1	1	1	0	0	0

Bit	D7	D6	D5	D4	D3	D2	D1	D0
Name	AIUOA[7]	AIUOA[6]	AIUOA[5]	AIUOA[4]	AIUOA[3]	AIUOA[2]	AIUOA[1]	AIUOA[0]
R/W	R/W	R/W	R/W	R/W	R/W	R/W	R/W	R/W
RTCRST	0	0	0	0	0	0	0	0
Other resets	0	0	0	0	0	0	0	0

Bit	Name	Function
D[15:0]	AIUOA[15:0]	Next DMA address [15:0] to be accessed for AIU output channel

(2) AIUOAHREG (0x0B00 002E)

Bit	D15	D14	D13	D12	D11	D10	D9	D8
Name	AIUOA[31]	AIUOA[30]	AIUOA[29]	AIUOA[28]	AIUOA[27]	AIUOA[26]	AIUOA[25]	AIUOA[24]
R/W	R	R	R	R	R	R	R	R/W
RTCRST	0	0	0	0	0	0	0	1
Other resets	0	0	0	0	0	0	0	1

Bit	D7	D6	D5	D4	D3	D2	D1	D0
Name	AIUOA[23]	AIUOA[22]	AIUOA[21]	AIUOA[20]	AIUOA[19]	AIUOA[18]	AIUOA[17]	AIUOA[16]
R/W	R/W	R/W	R/W	R/W	R/W	R/W	R/W	R/W
RTCRST	1	1	1	1	1	1	1	1
Other resets	1	1	1	1	1	1	1	1

Bit	Name	Function
D[15:0]	AIUOA[31:16]	Next DMA address [31:16] to be accessed for AIU output channel

11.2.5 FIR DMA Base Address Registers

(1) FIRBALREG (0x0B00 0030)

Bit	D15	D14	D13	D12	D11	D10	D9	D8
Name	FIRBA[15]	FIRBA[14]	FIRBA[13]	FIRBA[12]	FIRBA[11]	FIRBA[10]	FIRBA[9]	FIRBA[8]
R/W	R/W	R/W	R/W	R/W	R/W	R/W	R/W	R/W
RTCRST	1	1	1	1	1	0	0	0
Other resets	1	1	1	1	1	0	0	0

Bit	D7	D6	D5	D4	D3	D2	D1	D0
Name	FIRBA[7]	FIRBA[6]	FIRBA[5]	FIRBA[4]	FIRBA[3]	FIRBA[2]	FIRBA[1]	FIRBA[0]
R/W	R/W	R/W	R/W	R/W	R/W	R/W	R/W	R/W
RTCRST	0	0	0	0	0	0	0	0
Other resets	0	0	0	0	0	0	0	0

Bit	Name	Function
D[15:0]	FIRBA[15:0]	FIR DMA base address [15:0]

(2) FIRBAHREG (0x0B00 0032)

Bit	D15	D14	D13	D12	D11	D10	D9	D8
Name	FIRBA[31]	FIRBA[30]	FIRBA[29]	FIRBA[28]	FIRBA[27]	FIRBA[26]	FIRBA[25]	FIRBA[24]
R/W	R	R	R	R	R	R	R	R/W
RTCRST	0	0	0	0	0	0	0	1
Other resets	0	0	0	0	0	0	0	1

Bit	D7	D6	D5	D4	D3	D2	D1	D0
Name	FIRBA[23]	FIRBA[22]	FIRBA[21]	FIRBA[20]	FIRBA[19]	FIRBA[18]	FIRBA[17]	FIRBA[16]
R/W	R/W	R/W	R/W	R/W	R/W	R/W	R/W	R/W
RTCRST	1	1	1	1	1	1	1	1
Other resets	1	1	1	1	1	1	1	1

Bit	Name	Function
D[15:9]	FIRBA[31:25]	FIR DMA base address [31:25] Write 0 when writing. 0 is returned after a read.
D[8:0]	FIRBA[24:16]	FIR DMA base address [24:16]

FIRBALREG and FIRBAHREG are used to set the base addresses for the FIR DMA channel.

The addresses set to this register become DMA start addresses.

The FIR DMA channel is retained in DRAM as a 2-Kbyte buffer that starts at the address that is generated by masking the low-order 10 bits of the DMA start address.

11.2.6 FIR DMA Address Registers

(1) FIRALREG (0x0B00 0034)

Bit	D15	D14	D13	D12	D11	D10	D9	D8
Name	FIRA[15]	FIRA[14]	FIRA[13]	FIRA[12]	FIRA[11]	FIRA[10]	FIRA[9]	FIRA[8]
R/W	R/W	R/W	R/W	R/W	R/W	R/W	R/W	R/W
RTCRST	1	1	1	1	1	0	0	0
Other resets	1	1	1	1	1	0	0	0

Bit	D7	D6	D5	D4	D3	D2	D1	D0
Name	FIRA[7]	FIRA[6]	FIRA[5]	FIRA[4]	FIRA[3]	FIRA[2]	FIRA[1]	FIRA[0]
R/W	R/W	R/W	R/W	R/W	R/W	R/W	R/W	R/W
RTCRST	0	0	0	0	0	0	0	0
Other resets	0	0	0	0	0	0	0	0

Bit	Name	Function
D[15:0]	FIRA[15:0]	Next DMA address [15:0] to be accessed by FIR channel

(2) FIRAHREG (0x0B00 0036)

Bit	D15	D14	D13	D12	D11	D10	D9	D8
Name	FIRA[31]	FIRA[30]	FIRA[29]	FIRA[28]	FIRA[27]	FIRA[26]	FIRA[25]	FIRA[24]
R/W	R	R	R	R	R	R	R	R/W
RTCRST	0	0	0	0	0	0	0	1
Other resets	0	0	0	0	0	0	0	1

Bit	D7	D6	D5	D4	D3	D2	D1	D0
Name	FIRA[23]	FIRA[22]	FIRA[21]	FIRA[20]	FIRA[19]	FIRA[18]	FIRA[17]	FIRA[16]
R/W	R/W	R/W	R/W	R/W	R/W	R/W	R/W	R/W
RTCRST	1	1	1	1	1	1	1	1
Other resets	1	1	1	1	1	1	1	1

Bit	Name	Function
D[15:0]	FIRA[31:16]	Next DMA address [31:16] to be accessed by FIR channel

CHAPTER 12 DCU (DMA CONTROL UNIT)

This chapter describes the DCU register's operations and settings.

12.1 GENERAL

The DCU register is used for DMA control. Specifically, it controls acknowledgment from the BCU that handles bus arbitration and DMA requests from the on-chip peripheral I/O units (AIU and FIR). It also controls DMA enable/prohibit settings.

12.2 DMA PRIORITY CONTROL

When a conflict occurs between DMA requests sent from on-chip peripheral I/O units, the following priority levels are used to resolve the conflict. These priority levels cannot be changed.

Table 12-1. DMA Priority Levels

Priority level	Type of DMA operation
High	Audio input (recording)
↑	Audio output (playback)
Low	FIR transmission/reception

12.3 REGISTER SET

The DCU register set is described below.

Table 12-2. DCU Registers

Address	R/W	Register symbols	Function
0x0B00 0040	R/W	DMARSTREG	DMA Reset Register
0x0B00 0042	R	DMAIDLEREG	DMA Idle Register
0x0B00 0044	R/W	DMASENREG	DMA Sequencer Enable Register
0x0B00 0046	R/W	DMAMSKREG	DMA Mask Register
0x0B00 0048	R/W	DMAREQREG	DMA Request Register
0x0B00 004A	R/W	TDREG	Transfer Direction Register

These registers are described in detail below.

12.3.1 DMARSTREG (0x0B00 0040)

Bit	D15	D14	D13	D12	D11	D10	D9	D8
Name	Reserved	Reserved	Reserved	Reserved	Reserved	Reserved	Reserved	Reserved
R/W	R	R	R	R	R	R	R	R
RTCRST	0	0	0	0	0	0	0	0
Other resets	0	0	0	0	0	0	0	0

Bit	D7	D6	D5	D4	D3	D2	D1	D0
Name	Reserved	Reserved	Reserved	Reserved	Reserved	Reserved	Reserved	DMARST
R/W	R	R	R	R	R	R	R	R/W
RTCRST	0	0	0	0	0	0	0	0
Other resets	0	0	0	0	0	0	0	0

Bit	Name	Function
D[15..1]	Reserved	Write 0 when writing. 0 is returned after a read.
D[0]	DMARST	Reset DMA controller 0 : Reset 1 : Normal

This register is used to reset the DMA controller.

12.3.2 DMAIDLEREG (0x0B00 0042)

Bit	D15	D14	D13	D12	D11	D10	D9	D8
Name	Reserved	Reserved	Reserved	Reserved	Reserved	Reserved	Reserved	Reserved
R/W	R	R	R	R	R	R	R	R
RTCRST	0	0	0	0	0	0	0	0
Other resets	0	0	0	0	0	0	0	0

Bit	D7	D6	D5	D4	D3	D2	D1	D0
Name	Reserved	Reserved	Reserved	Reserved	Reserved	Reserved	Reserved	DMAISTAT
R/W	R	R	R	R	R	R	R	R
RTCRST	0	0	0	0	0	0	0	0
Other resets	0	0	0	0	0	0	0	0

Bit	Name	Function
D[15..1]	Reserved	Write 0 when writing. 0 is returned after a read.
D[0]	DMAISTAT	Display DMA sequencer status 1 : D_IDLE status 0 : DMA busy

This register is used to display the DMA sequencer status.

12.3.3 DMASENREG (0x0B00 0044)

Bit	D15	D14	D13	D12	D11	D10	D9	D8
Name	Reserved	Reserved	Reserved	Reserved	Reserved	Reserved	Reserved	Reserved
R/W	R	R	R	R	R	R	R	R
RTCST	0	0	0	0	0	0	0	0
Other resets	0	0	0	0	0	0	0	0

Bit	D7	D6	D5	D4	D3	D2	D1	D0
Name	Reserved	Reserved	Reserved	Reserved	Reserved	Reserved	Reserved	DMASEN
R/W	R	R	R	R	R	R	R	R/W
RTCST	0	0	0	0	0	0	0	0
Other resets	0	0	0	0	0	0	0	0

Bit	Name	Function
D[15..1]	Reserved	Write 0 when writing. 0 is returned after a read.
D[0]	DMASEN	Enable DMA sequencer 1 : Enable 0 : Prohibit

This register is used to enable/prohibit the DMA sequencer.

12.3.4 DMAMSKREG (0x0B00 0046)

Bit	D15	D14	D13	D12	D11	D10	D9	D8
Name	Reserved	Reserved	Reserved	Reserved	Reserved	Reserved	Reserved	Reserved
R/W	R	R	R	R	R	R	R	R
RTCRST	0	0	0	0	0	0	0	0
Other resets	0	0	0	0	0	0	0	0

Bit	D7	D6	D5	D4	D3	D2	D1	D0
Name	Reserved	Reserved	Reserved	Reserved	DMAMSKAIN	DMAMSKAOUT	Reserved	DMAMSKFOUT
R/W	R	R	R	R	R/W	R/W	R	R/W
RTCRST	0	0	0	0	0	0	0	0
Other resets	0	0	0	0	0	0	0	0

Bit	Name	Function
D[15..4]	Reserved	Write 0 when writing. 0 is returned after a read.
D[3]	DMAMSKAIN	Audio input DMA transfer enable/prohibit 1 : Enable 0 : Prohibit
D[2]	DMAMSKAOUT	Audio output DMA transfer enable/prohibit 1 : Enable 0 : Prohibit
D[1]	Reserved	Write 0 when writing. 0 is returned after a read.
D[0]	DMAMSKFOUT	FIR transmission DMA transfer enable/prohibit 1 : Enable 0 : Prohibit

This register is used to enable/prohibit various types of DMA transfers.

The DMA transfer enable bits should be set when the units that receive DMA service have been stopped or when there are no pending DMA requests. If any of the above bits are set to a unit while a DMA request is pending for that unit, the CPU's operation will be undefined.

12.3.5 DMAREQREG (0x0B00 0048)

Bit	D15	D14	D13	D12	D11	D10	D9	D8
Name	Reserved	Reserved	Reserved	Reserved	Reserved	Reserved	Reserved	Reserved
R/W	R	R	R	R	R	R	R	R
RTCRST	0	0	0	0	0	0	0	0
Other resets	0	0	0	0	0	0	0	0

Bit	D7	D6	D5	D4	D3	D2	D1	D0
Name	Reserved	Reserved	Reserved	Reserved	DRQAIN	DRQAOUT	Reserved	DRQFOUT
R/W	R	R	R	R	R	R	R	R
RTCRST	0	0	0	0	0	0	0	0
Other resets	0	0	0	0	0	0	0	0

Bit	Name	Function
D[15..4]	Reserved	Write 0 when writing. 0 is returned after a read.
D[3]	DRQAIN	Audio input DMA transfer request 1 : Request pending 0 : No request
D[2]	DRQAOUT	Audio output DMA transfer request 1 : Request pending 0 : No request
D[1]	Reserved	Write 0 when writing. 0 is returned after a read.
D[0]	DRQFOUT	FIR transmission DMA transfer request 1 : Request pending 0 : No request

This register is used to indicate whether or not there are any DMA transfer requests.

12.3.6 TDREG (0x0B00 004A)

Bit	D15	D14	D13	D12	D11	D10	D9	D8
Name	Reserved	Reserved	Reserved	Reserved	Reserved	Reserved	Reserved	Reserved
R/W	R	R	R	R	R	R	R	R
RTCST	0	0	0	0	0	0	0	0
Other resets	0	0	0	0	0	0	0	0

Bit	D7	D6	D5	D4	D3	D2	D1	D0
Name	Reserved	Reserved	Reserved	Reserved	Reserved	Reserved	Reserved	FIR
R/W	R	R	R	R	R	R	R	R/W
RTCST	0	0	0	0	0	0	0	0
Other resets	0	0	0	0	0	0	0	0

Bit	Name	Function
D[15..1]	Reserved	Write 0 when writing. 0 is returned after a read.
D[0]	FIR	Transfer direction of DMA channel for FIR transmission 1 : I/O → MEM 0 : MEM → I/O

This register is used to set the transfer direction of DMA channel for FIR transmission.

[MEMO]

CHAPTER 13 CMU (CLOCK MASK UNIT)

This chapter describes the CMU register's operations and settings.

13.1 GENERAL

As various input clocks (ctclock, i_seclk, firclock) are supplied from the CPU to each unit, a masking method enables power consumption to be curtailed in units that are not used.

The units for which this masking method are used are the KIU, PIU, AIU, SIU, DSIU, FIR, and HSP (software modem interface) units.

The basic functions are described below.

1. Control of TClock supplied to PIU, AIU, SIU, KIU, DSIU, and FIR
2. Control of internal clock (18.432 MHz) supplied to SIU and HSP
3. Control of internal clock (48 MHz) supplied to FIR

The initial value is "0", which specifies masking. No clock is supplied unless the CPU writes "1" to CMUCLKMSK register.

Figure 13-1. Block Diagram of CMU and Peripheral Blocks

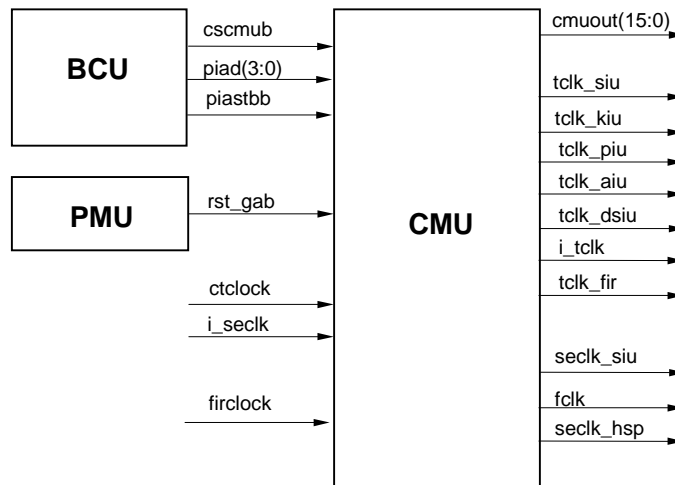

13.2 REGISTER SET

The CMU register is listed below.

Table 13-1. CMU Register

Address	R/W	Register symbol	Function
0x0B00 0060	R/W	CMUCLKMSK	CMU Clock Mask Register

This register is described in detail below.

13.2.1 CMUCLKMSK (0x0B00 0060)

Bit	D15	D14	D13	D12	D11	D10	D9	D8
Name	Reserved	Reserved	Reserved	Reserved	Reserved	MSKFFIR	MSKSHSP	MSKSSIU
R/W	R	R	R	R	R	R/W	R/W	R/W
RTCRST	0	0	0	0	0	0	0	0
Other resets	0	0	0	0	0	0	0	0

Bit	D7	D6	D5	D4	D3	D2	D1	D0
Name	Reserved	Reserved	MSKDSIU	MSKFIR	MSKKIU	MSKAIU	MSKSIU	MSKPIU
R/W	R	R	R/W	R/W	R/W	R/W	R/W	R/W
RTCRST	0	0	0	0	0	0	0	0
Other resets	0	0	0	0	0	0	0	0

Bit	Name	Function
D[15:11]	Reserved	Write 0 when writing. 0 is returned after a read.
D[10]	MSKFFIR	Supply/mask 48-MHz clock to FIR unit 1 : Supply 0 : Mask
D[9]	MSKSHSP	Supply/mask 18.432-MHz clock to HSP unit 1 : Supply 0 : Mask
D[8]	MSKSSIU	Supply/mask 18.432-MHz clock to SIU unit 1 : Supply 0 : Mask
D[7:6]	Reserved	Write 0 when writing. 0 is returned after a read.
D[5]	MSKDSIU	Supply/mask TClock to DSU unit 1 : Supply 0 : Mask
D[4]	MSKFIR	Supply/mask TClock to FIR unit 1 : Supply 0 : Mask
D[3]	MSKKIU	Supply/mask TClock to KIU unit 1 : Supply 0 : Mask
D[2]	MSKAIU	Supply/mask TClock to AIU unit 1 : Supply 0 : Mask
D[1]	MSKSIU	Supply/mask TClock to SIU unit 1 : Supply 0 : Mask
D[0]	MSKPIU	Supply/mask TClock to PIU unit 1 : Supply 0 : Mask

This register is used to mask the clocks that are supplied to the KIU, PIU, AIU, SIU, DSU, FIR, and HSP units.

CHAPTER 14 ICU (INTERRUPT CONTROL UNIT)

This chapter describes the ICU register's operations and settings.

14.1 GENERAL

The ICU collects interrupt signals from the various on-chip peripheral units and transfers these interrupt signals (Int0, Int1, Int2, Int3, and NMI) to the CPU core.

The functions of the ICU's internal blocks are briefly described below.

- ADDECICU ... Decodes read/write addresses from the CPU that are used for ICU registers.
- REGICU ... This includes a register for interrupt masking. The initial value is "0", which specifies masking. No interrupt signal is supplied to CPU core unless the CPU writes "1" to this register.
- OUTICU ... This is the general ICU output that follows masking of interrupts (all output is at the rising edge of I_mclkin). It also controls the interrupt masking signal (doze_mskint) used for settings during Suspend mode, assertion of the general interrupt source signal (int_all), and the memdrv assertion timing signal (doze_memdrv) that is used when resetting from Suspend mode.

The signals used to notice interrupt request to the CPU are as below.

NMI : battint_intr only

Switching between NMI and Int0 is enabled according to this register's settings.

Because NMI's interrupt masking cannot be controlled by means of software, switch to Int0 to mask battint_Intr.

Int3 : hsp_intr only

Int2 : rtc_long2_intr only

Int1 : rtc_long1_intr only

The IT (interval timer) and HSP interrupts require more responsiveness than do other interrupt sources.

Int0 : All other interrupts

For details of the interrupt sources, see the register set.

How an interrupt request is notified to the CPU core is shown below.

If an interrupt request occurs in the peripheral units, the corresponding bit in the interrupt indication register of Level 2 (xxxINTREG) is set to 1. The interrupt indication register is ANDed bit-wise with the corresponding interrupt mask register of Level 2 (MxxxINTREG). If the occurred interrupt request is enabled (set to 1) in the mask register, the interrupt request is notified to the interrupt indication register of Level 1 (SYSINTREG) and the corresponding bit is set to 1. At this time, the interrupt requests from the same register of Level 2 are notified to the SYSINTREG as a single interrupt request.

Interrupt requests from some units directly set their corresponding bits in the SYSINTREG.

The SYSINTREG is ANDed bit-wise with the interrupt mask register of Level 1 (MSYSINTREG). If the interrupt request is enabled by MSYSINTREG (set to 1), a corresponding interrupt request signal is output from the ICU to the CPU core. battint is connected to the NMI or Int0 signal of the CPU core (selected by setting of NMIREG). rtc_long signals are connected to the Int3 signal of the CPU core. The other interrupt requests are connected to the Int0 signal of the CPU core as a one interrupt request.

The following figure shows an outline of interrupt control in the ICU.

Figure 14-1. Interrupt Control Outline

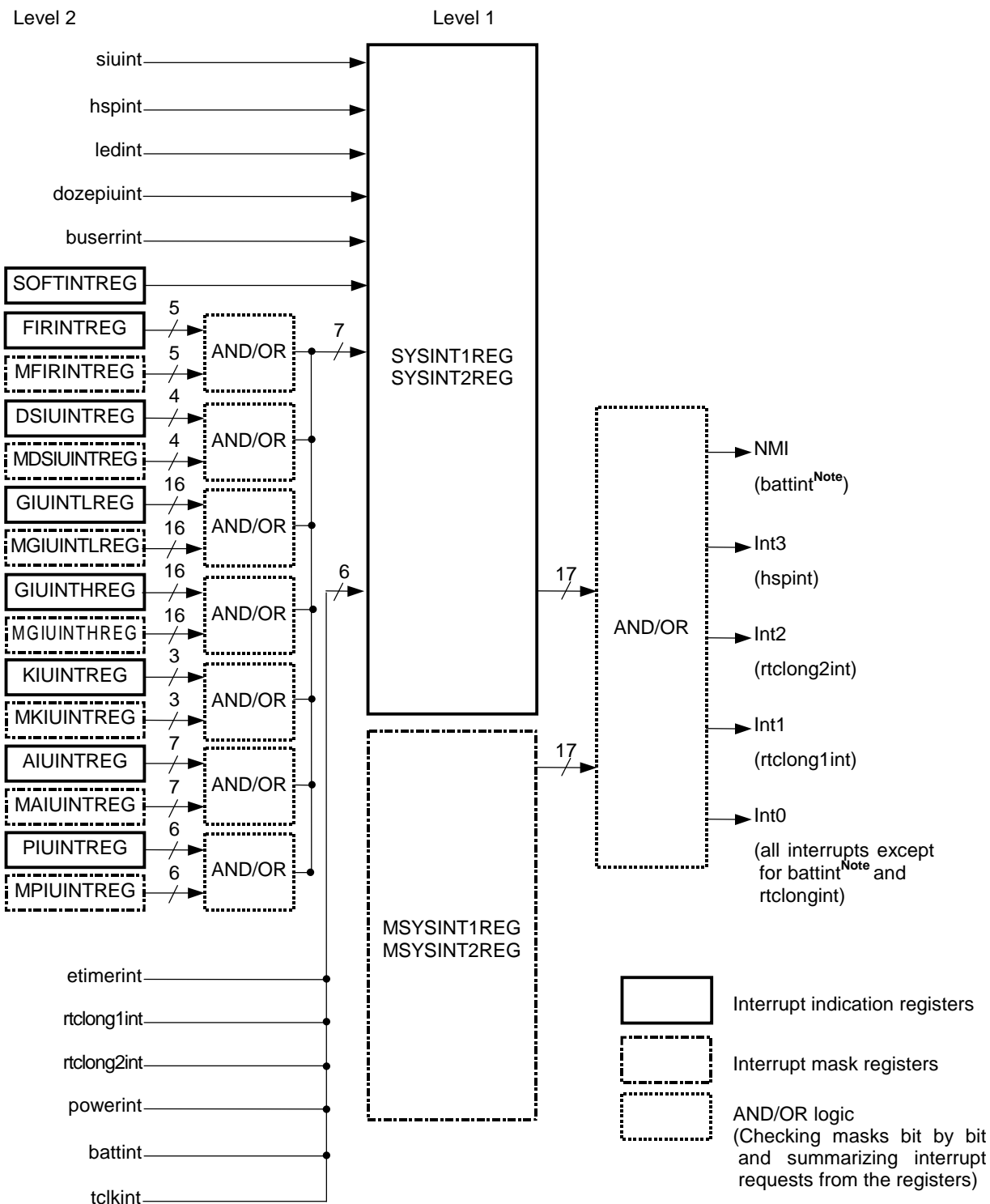

14.2 REGISTER SET

The ICU registers are listed below.

Table 14-1. ICU Registers

Address	R/W	Register symbols	Function
0x0B00 0080	R	SYSINT1REG	Level 1 System interrupt register 1
0x0B00 0082	R	PIUINTREG	Level 2 PIU interrupt register
0x0B00 0084	R	AIUINTREG	Level 2 AIU interrupt register
0x0B00 0086	R	KIUINTREG	Level 2 KIU interrupt register
0x0B00 0088	R	GIUINTLREG	Level 2 GIU interrupt register Low
0x0B00 008A	R	DSIUINTREG	Level 2 DSIU interrupt register
0x0B00 008C	R/W	MSYSINT1REG	Level 1 mask system interrupt register 1
0x0B00 008E	R/W	MPIUINTREG	Level 2 mask PIU interrupt register
0x0B00 0090	R/W	MAIUINTREG	Level 2 mask AIU interrupt register
0x0B00 0092	R/W	MKIUINTREG	Level 2 mask KIU interrupt register
0x0B00 0094	R/W	MGIUINTLREG	Level 2 mask GIU interrupt register Low
0x0B00 0096	R/W	MDSIUINTREG	Level 2 mask DSIU interrupt register
0x0B00 0098	R/W	NMIREG	NMI register
0x0B00 009A	R/W	SOFTINTREG	Software interrupt register
0x0B00 0200	R	SYSINT2REG	Level 1 System interrupt register 2
0x0B00 0202	R	GIUINTHREG	Level 2 GIU interrupt register High
0x0B00 0204	R	FIRINTREG	Level 2 FIR interrupt register
0x0B00 0206	R/W	MSYSINT2REG	Level 1 mask system interrupt register 2
0x0B00 0208	R/W	MGIUINTHREG	Level 2 mask GIU interrupt register High
0x0B00 020A	R/W	MFIRINTREG	Level 2 mask FIR interrupt register

These registers are described in detail below.

14.2.1 SYSINT1REG (0x0B00 0080)

(1/2)

Bit	D15	D14	D13	D12	D11	D10	D9	D8
Name	Reserved	Reserved	DOZE PIUINTR	Reserved	SOFTINTR	WRBER RINTR	SIUINTR	GIUINTR
R/W	R	R	R	R	R	R	R	R
RTCRST	0	0	0	0	0	0	0	0
Other resets	0	0	0	0	0	0	0	0

Bit	D7	D6	D5	D4	D3	D2	D1	D0
Name	KIUINTR	AIUINTR	PIUINTR	Reserved	ETIMER INTR	RTCL1INTR	POWER INTR	BATINTR
R/W	R	R	R	R	R	R	R	R
RTCRST	0	0	0	0	0	0	0	0
Other resets	0	0	0	0	0	0	0	0

Bit	Name	Function
D[15..14]	Reserved	Write 0 when writing. 0 is returned after a read.
D[13]	DOZEPIUINTR	PIU interrupt during Suspend mode 1 : Occurred 0 : Normal
D[12]	Reserved	Write 0 when writing. 0 is returned after a read.
D[11]	SOFTINTR	Software interrupt (occurs by setting the SOFTINTREG) 1 : Occurred 0 : Normal
D[10]	WRBERRINTR	Bus error interrupt 1 : Occurred 0 : Normal
D[9]	SIUINTR	SIU interrupt 1 : Occurred 0 : Normal
D[8]	GIUINTR	GIU interrupt 1 : Occurred 0 : Normal
D[7]	KIUINTR	KIU interrupt 1 : Occurred 0 : Normal
D[6]	AIUINTR	AIU interrupt 1 : Occurred 0 : Normal

Bit	Name	Function
D[5]	PIUINTR	PIU interrupt 1 : Occurred 0 : Normal
D[4]	Reserved	Write 0 when writing. 0 is returned after a read.
D[3]	ETIMERINTR	ETIMER interrupt 1 : Occurred 0 : Normal
D[2]	RTCL1INTR	RTCLong1 interrupt 1 : Occurred 0 : Normal
D[1]	POWERINTR	PowerSW interrupt 1 : Occurred 0 : Normal
D[0]	BATINTR	Battery interrupt 1 : Occurred 0 : Normal

This register indicates when various interrupts occur in the VR4102 system.

14.2.2 PIUINTREG (0x0B00 0082)

Bit	D15	D14	D13	D12	D11	D10	D9	D8
Name	Reserved	Reserved	Reserved	Reserved	Reserved	Reserved	Reserved	Reserved
R/W	R	R	R	R	R	R	R	R
RTCRST	0	0	0	0	0	0	0	0
Other resets	0	0	0	0	0	0	0	0

Bit	D7	D6	D5	D4	D3	D2	D1	D0
Name	Reserved	PADCMD INTR	PADADP INTR	PADPAGE1 INTR	PADPAGE0 INTR	PADDLOST INTR	Reserved	PENCHG INTR
R/W	R	R	R	R	R	R	R	R
RTCRST	0	0	0	0	0	0	0	0
Other resets	0	0	0	0	0	0	0	0

Bit	Name	Function
D[15..7]	Reserved	Write 0 when writing. 0 is returned after a read.
D[6]	PADCMDINTR	PIU command scan interrupt. This interrupt occurs when command scan found valid data. 1 : Occurred 0 : Normal
D[5]	PADADPINTR	PIU AD port scan interrupt. This interrupt occurs when AD port scan found a set of valid data. 1 : Occurred 0 : Normal
D[4]	PADPAGE1INTR	PIU data buffer page 1 interrupt. This interrupt occurs when a set of valid data is stored in page 1 of data buffer. 1 : Occurred 0 : Normal
D[3]	PADPAGE0INTR	PIU data buffer page 0 interrupt. This interrupt occurs when a set of valid data is stored in page 0 of data buffer. 1 : Occurred 0 : Normal
D[2]	PADDLOSTINTR	A/D data timeout interrupt. This interrupt occurs when a set of data did not found within specified time. 1 : Occurred 0 : Normal
D[1]	Reserved	Write 0 when writing. 0 is returned after a read.
D[0]	PENCHGINTR	Touch panel contact status change interrupt 1: Change has occurred 0: No change

This register indicates when various PIU-related interrupts occur.

14.2.3 AIUINTREG (0x0B00 0084)

Bit	D15	D14	D13	D12	D11	D10	D9	D8
Name	Reserved	Reserved	Reserved	Reserved	INTMEND	INTM	INTMIDDLE	INTMST
R/W	R	R	R	R	R	R	R	R
RTCRST	0	0	0	0	0	0	0	0
Other resets	0	0	0	0	0	0	0	0

Bit	D7	D6	D5	D4	D3	D2	D1	D0
Name	Reserved	Reserved	Reserved	Reserved	INTSEND	INTS	INTSIDLE	Reserved
R/W	R	R	R	R	R	R	R	R
RTCRST	0	0	0	0	0	0	0	0
Other resets	0	0	0	0	0	0	0	0

Bit	Name	Function
D[15:12]	Reserved	Write 0 when writing. 0 is returned after a read.
D[11]	INTMEND	Audio input (MIC) DMA buffer 2 page interrupt 1: Occurred 0: Normal
D[10]	INTM	Audio input (MIC) DMA buffer 1 page interrupt 1: Occurred 0: Normal
D[9]	INTMIDDLE	Audio input (MIC) idle interrupt (received data is lost). This interrupt occurs if valid data exists in MIDATREG when data was received from A/D converter. 1: Occurred 0: Normal
D[8]	INTMST	Audio input (MIC) receive completion interrupt. This interrupt occurs when 10-bit converted data was received from the A/D converter. 1: Occurred 0: Normal
D[7:4]	Reserved	Write 0 when writing. 0 is returned after a read
D[3]	INTSEND	Audio output (speaker) DMA buffer 2 page interrupt 1: Occurred 0: Normal
D[2]	INTS	Audio output (speaker) DMA buffer 1 page interrupt 1: Occurred 0: Normal
D[1]	INTSIDLE	Audio output (speaker) idle interrupt (mute). This interrupt occurs if there is no valid data in SODATREG when data was transferred to D/A. 1: Occurred 0: Normal
D[0]	Reserved	Write 0 when writing. 0 is returned after a read

This register indicates when various AIU-related interrupts occur.

14.2.4 KIUINTREG (0x0B00 0086)

Bit	D15	D14	D13	D12	D11	D10	D9	D8
Name	Reserved	Reserved	Reserved	Reserved	Reserved	Reserved	Reserved	Reserved
R/W	R	R	R	R	R	R	R	R
RTCRST	0	0	0	0	0	0	0	0
Other resets	0	0	0	0	0	0	0	0

Bit	D7	D6	D5	D4	D3	D2	D1	D0
Name	Reserved	Reserved	Reserved	Reserved	Reserved	KDATLOST	KDATRDY	SCANINT
R/W	R	R	R	R	R	R	R	R
RTCRST	0	0	0	0	0	0	0	0
Other resets	0	0	0	0	0	0	0	0

Bit	Name	Function
D[15..3]	Reserved	Write 0 when writing. 0 is returned after a read.
D[2]	KDATLOST	Key scan data lost interrupt 1 : Occurred 0 : Normal
D[1]	KDATRDY	Key scan data complete interrupt 1 : Occurred 0 : Normal
D[0]	SCANINT	Key input detect interrupt 1 : Occurred 0 : Normal

This register indicates when various KIU-related interrupts occur.

14.2.5 GIUINTLREG (0x0B00 0088)

Bit	D15	D14	D13	D12	D11	D10	D9	D8
Name	INTS[15]	INTS[14]	INTS[13]	INTS[12]	INTS[11]	INTS[10]	INTS[9]	INTS[8]
R/W	R	R	R	R	R	R	R	R
RTCST	0	0	0	0	0	0	0	0
Other resets	0	0	0	0	0	0	0	0

Bit	D7	D6	D5	D4	D3	D2	D1	D0
Name	INTS[7]	INTS[6]	INTS[5]	INTS[4]	INTS[3]	INTS[2]	INTS[1]	INTS[0]
R/W	R	R	R	R	R	R	R	R
RTCST	0	0	0	0	0	0	0	0
Other resets	0	0	0	0	0	0	0	0

Bit	Name	Function
D[15..0]	INTS[15..0]	Interrupt to GPIO[15..0] pin 1 : Occurred 0 : Normal

This register indicates when various GIU-related interrupts occur.

14.2.6 DSIUINTREG (0x0B00 008A)

Bit	D15	D14	D13	D12	D11	D10	D9	D8
Name	Reserved	Reserved	Reserved	Reserved	INTDCTS	INTSER0	INTSR0	INTST0
R/W	R	R	R	R	R	R	R	R
RTCRST	0	0	0	0	0	0	0	0
Other resets	0	0	0	0	0	0	0	0

Bit	D7	D6	D5	D4	D3	D2	D1	D0
Name	Reserved	Reserved	Reserved	Reserved	Reserved	Reserved	Reserved	Reserved
R/W	R	R	R	R	R	R	R	R
RTCRST	0	0	0	0	0	0	0	1
Other resets	0	0	0	0	0	0	0	1

Bit	Name	Function
D[15..12]	Reserved	Write 0 when writing. 0 is returned after a read.
D[11]	INTDCTS	DCTS# change interrupt 1 : Occurred 0 : Normal
D[10]	INTSER0	Debug serial receive error interrupt 1 : Occurred 0 : Normal
D[9]	INTSR0	Debug serial receive complete interrupt 1 : Occurred 0 : Normal
D[8]	INTST0	Debug serial transmit complete interrupt 1 : Occurred 0 : Normal
D[7..1]	Reserved	Write 0 when writing. 0 is returned after a read.
D[0]	Reserved	Write 1 when writing. 1 is returned after a read.

This register indicates when various DSIU-related interrupts occur.

14.2.7 MSYSINT1REG (0x0B00 008C)

(1/2)

Bit	D15	D14	D13	D12	D11	D10	D9	D8
Name	Reserved	Reserved	DOZE PIUINTR	Reserved	SOFTINTR	WRBERR INTR	SIUINTR	GIUINTR
R/W	R	R	R/W	R	R/W	R/W	R/W	R/W
RTCRST	0	0	0	0	0	0	0	0
Other resets	0	0	0	0	0	0	0	0

Bit	D7	D6	D5	D4	D3	D2	D1	D0
Name	KIUINTR	AIUINTR	PIUINTR	Reserved	ETIMER INTR	RTCL1INTR	POWER INTR	BATINTR
R/W	R/W	R/W	R/W	R	R/W	R/W	R/W	R/W
RTCRST	0	0	0	0	0	0	0	0
Other resets	0	0	0	0	0	0	0	0

Bit	Name	Function
D[15..14]	Reserved	Write 0 when writing. 0 is returned after a read.
D[13]	DOZEPIUINTR	PIU interrupt enable during suspend mode 1: Enable 0: Prohibit
D[12]	Reserved	Write 0 when writing. 0 is returned after a read.
D[11]	SOFTINTR	Software interrupt (occurs by setting the SOFTINTREG) enable 1: Enable 0: Prohibit
D[10]	WRBERRINTR	Bus error interrupt enable 1: Enable 0: Prohibit
D[9]	SIUINTR	SIU interrupt enable 1: Enable 0: Prohibit
D[8]	GIUINTR	GIU interrupt enable 1: Enable 0: Prohibit
D[7]	KIUINTR	KIU interrupt enable 1: Enable 0: Prohibit
D[6]	AIUINTR	AIU interrupt enable 1: Enable 0: Prohibit

Bit	Name	Function
D[5]	PIUINTR	PIU interrupt enable 1 : Enable 0 : Prohibit
D[4]	Reserved	Write 0 when writing. 0 is returned after a read.
D[3]	ETIMERINTR	ETIMER interrupt enable 1 : Enable 0 : Prohibit
D[2]	RTCL1INTR	RTCLong1 timer interrupt enable 1 : Enable 0 : Prohibit
D[1]	POWERINTR	PowerSW interrupt enable 1 : Enable 0 : Prohibit
D[0]	BATINTR	Battery interrupt enable 1 : Enable 0 : Prohibit

This register is used to mask various interrupts that occur in the VR4102 system.

14.2.8 MPIUINTREG (0x0B00 008E)

Bit	D15	D14	D13	D12	D11	D10	D9	D8
Name	Reserved	Reserved	Reserved	Reserved	Reserved	Reserved	Reserved	Reserved
R/W	R	R	R	R	R	R	R	R
RTCRST	0	0	0	0	0	0	0	0
Other resets	0	0	0	0	0	0	0	0

Bit	D7	D6	D5	D4	D3	D2	D1	D0
Name	Reserved	PADCMD INTR	PADADP INTR	PADPAGE1 INTR	PADPAGE0 INTR	PADDLOST INTR	Reserved	PENCHG INTR
R/W	R	R/W	R/W	R/W	R/W	R/W	R	R/W
RTCRST	0	0	0	0	0	0	0	0
Other resets	0	0	0	0	0	0	0	0

Bit	Name	Function
D[15..7]	Reserved	Write 0 when writing. 0 is returned after a read.
D[6]	PADCMDINTR	PIU command scan interrupt enable 1 : Enable 0 : Prohibit
D[5]	PADADPINTR	PIU A/D port scan interrupt enable 1 : Enable 0 : Prohibit
D[4]	PADPAGE1INTR	PIU data buffer page 1 interrupt enable 1 : Enable 0 : Prohibit
D[3]	PADPAGE0INTR	PIU data buffer page 0 interrupt enable 1 : Enable 0 : Prohibit
D[2]	PADDLOSTINTR	A/D data timeout interrupt enable 1 : Enable 0 : Prohibit
D[1]	Reserved	Write 0 when writing. 0 is returned after a read.
D[0]	PENCHGINTR	Touch panel contact status change interrupt enable 1 : Enable 0 : Prohibit

This register is used to mask various PIU-related interrupts.

14.2.9 MAUIINTREG (0x0B00 0090)

Bit	D15	D14	D13	D12	D11	D10	D9	D8
Name	Reserved	Reserved	Reserved	Reserved	INTMEND	INTM	INTMIDDLE	INTMST
R/W	R	R	R	R	R/W	R/W	R/W	R/W
RTCRST	0	0	0	0	0	0	0	0
Other resets	0	0	0	0	0	0	0	0

Bit	D7	D6	D5	D4	D3	D2	D1	D0
Name	Reserved	Reserved	Reserved	Reserved	INTSEND	INTS	INTSIDLE	Reserved
R/W	R	R	R	R	R/W	R/W	R/W	R
RTCRST	0	0	0	0	0	0	0	0
Other resets	0	0	0	0	0	0	0	0

Bit	Name	Function
D[15:12]	Reserved	Write 0 when writing. 0 is returned after a read.
D[11]	INTMEND	Audio input (MIC) DMA buffer 2 page interrupt enable 1 : Enable 0 : Prohibit
D[10]	INTM	Audio input (MIC) DMA buffer 1 page interrupt enable 1 : Enable 0 : Prohibit
D[9]	INTMIDDLE	Audio input (MIC) idle interrupt (received data is lost) enable 1 : Enable 0 : Prohibit
D[8]	INTMST	Audio input (MIC) receive complete interrupt 1 : Enable 0 : Prohibit
D[7:4]	Reserved	Write 0 when writing. 0 is returned after a read.
D[3]	INTSEND	Audio output (speaker) DMA buffer 2 page interrupt enable 1 : Enable 0 : Prohibit
D[2]	INTS	Audio output (speaker) DMA buffer 1 page interrupt enable 1 : Enable 0 : Prohibit
D[1]	INTSIDLE	Audio output (speaker) idle interrupt (mute) enable 1 : Enable 0 : Prohibit
D[0]	Reserved	Write 0 when writing. 0 is returned after a read.

This register is used to mask various AIU-related interrupts.

14.2.10 MKIUINTREG (0x0B00 0092)

Bit	D15	D14	D13	D12	D11	D10	D9	D8
Name	Reserved	Reserved	Reserved	Reserved	Reserved	Reserved	Reserved	Reserved
R/W	R	R	R	R	R	R	R	R
RTCRST	0	0	0	0	0	0	0	0
Other resets	0	0	0	0	0	0	0	0

Bit	D7	D6	D5	D4	D3	D2	D1	D0
Name	Reserved	Reserved	Reserved	Reserved	Reserved	KDATLOST	KDATRDY	SCANINT
R/W	R	R	R	R	R	R/W	R/W	R/W
RTCRST	0	0	0	0	0	0	0	0
Other resets	0	0	0	0	0	0	0	0

Bit	Name	Function
D[15..3]	Reserved	Write 0 when writing. 0 is returned after a read.
D[2]	KDATLOST	Key data scan lost interrupt enable 1 : Enable 0 : Prohibit
D[1]	KDATRDY	Key scan data complete interrupt enable 1 : Enable 0 : Prohibit
D[0]	SCANINT	Key input detect interrupt enable 1 : Enable 0 : Prohibit

This register is used to mask various KIU-related interrupts.

14.2.11 MGIUINTLREG (0x0B00 0094)

Bit	D15	D14	D13	D12	D11	D10	D9	D8
Name	INTS[15]	INTS[14]	INTS[13]	INTS[12]	INTS[11]	INTS[10]	INTS[9]	INTS[8]
R/W	R/W	R/W	R/W	R/W	R/W	R/W	R/W	R/W
RTCRST	0	0	0	0	0	0	0	0
Other resets	0	0	0	0	0	0	0	0

Bit	D7	D6	D5	D4	D3	D2	D1	D0
Name	INTS[7]	INTS[6]	INTS[5]	INTS[4]	INTS[3]	INTS[2]	INTS[1]	INTS[0]
R/W	R/W	R/W	R/W	R/W	R/W	R/W	R/W	R/W
RTCRST	0	0	0	0	0	0	0	0
Other resets	0	0	0	0	0	0	0	0

Bit	Name	Function
D[15..0]	INTS[15..0]	GPIO[15..0] pin interrupt enable 1 : Enable 0 : Prohibit

This register is used to mask various GIU-related interrupts.

14.2.12 MDSIUINTREG (0x0B00 0096)

Bit	D15	D14	D13	D12	D11	D10	D9	D8
Name	Reserved	Reserved	Reserved	Reserved	INTDCTS	INTSER0	INTSR0	INTST0
R/W	R	R	R	R	R/W	R/W	R/W	R/W
RTCRST	0	0	0	0	0	0	0	0
Other resets	0	0	0	0	0	0	0	0

Bit	D7	D6	D5	D4	D3	D2	D1	D0
Name	Reserved	Reserved	Reserved	Reserved	Reserved	Reserved	Reserved	Reserved
R/W	R	R	R	R	R	R	R	R
RTCRST	0	0	0	0	0	0	0	0
Other resets	0	0	0	0	0	0	0	0

Bit	Name	Function
D[15..12]	Reserved	Write 0 when writing. 0 is returned after a read.
D[11]	INTDCTS	DCTS# change interrupt enable 1 : Enable 0 : Prohibit
D[10]	INTSER0	Debug serial data receive error interrupt enable 1 : Enable 0 : Prohibit
D[9]	INTSR0	Debug serial data receive complete interrupt enable 1 : Enable 0 : Prohibit
D[8]	INTST0	Debug serial data transmit complete interrupt enable 1 : Enable 0 : Prohibit
D[7..0]	Reserved	Write 0 when writing. 0 is returned after a read.

This register is used to mask various DSIU-related interrupts.

14.2.13 NMIREG (0x0B00 0098)

Bit	D15	D14	D13	D12	D11	D10	D9	D8
Name	Reserved	Reserved	Reserved	Reserved	Reserved	Reserved	Reserved	Reserved
R/W	R	R	R	R	R	R	R	R
RTCRST	0	0	0	0	0	0	0	0
Other resets	0	0	0	0	0	0	0	0

Bit	D7	D6	D5	D4	D3	D2	D1	D0
Name	Reserved	Reserved	Reserved	Reserved	Reserved	Reserved	Reserved	NMIORINT
R/W	R	R	R	R	R	R	R	R/W
RTCRST	0	0	0	0	0	0	0	0
Other resets	0	0	0	0	0	0	0	0

Bit	Name	Function
D[15..1]	Reserved	Write 0 when writing. 0 is returned after a read.
D[0]	NMIORINT	Low battery detect interrupt type setting 1 : Int0 0 : NMI

This register is used to set the type of interrupt used to notify the Vr4100 CPU core when a low battery detect interrupt has occurred.

14.2.14 SOFTINTREG (0x0B00 009A)

Bit	D15	D14	D13	D12	D11	D10	D9	D8
Name	Reserved	Reserved	Reserved	Reserved	Reserved	Reserved	Reserved	Reserved
R/W	R	R	R	R	R	R	R	R
RTCRST	0	0	0	0	0	0	0	0
Other resets	0	0	0	0	0	0	0	0

Bit	D7	D6	D5	D4	D3	D2	D1	D0
Name	Reserved	Reserved	Reserved	Reserved	SOFTINTR[3]	SOFTINTR[2]	SOFTINTR[1]	SOFTINTR[0]
R/W	R	R	R	R	R/W	R/W	R/W	R/W
RTCRST	0	0	0	0	0	0	0	0
Other resets	0	0	0	0	0	0	0	0

Bit	Name	Function
D[15..4]	Reserved	Write 0 when writing. 0 is returned after a read.
D[3..0]	SOFTINTR[3..0]	Set/clear software interrupt 1 : Set 0 : Clear

This register is used to set software interrupts. Each bit can be set separately, and can cause four types of interrupts.

14.2.15 SYSINT2REG (0x0B00 0200)

Bit	D15	D14	D13	D12	D11	D10	D9	D8
Name	Reserved	Reserved	Reserved	Reserved	Reserved	Reserved	Reserved	Reserved
R/W	R	R	R	R	R	R	R	R
RTCRST	0	0	0	0	0	0	0	0
Other resets	0	0	0	0	0	0	0	0

Bit	D7	D6	D5	D4	D3	D2	D1	D0
Name	Reserved	Reserved	DSIUINTR	FIRINTR	TCLKINTR	HSPINTR	LEDINTR	RTCL2INTR
R/W	R	R	R	R	R	R	R	R
RTCRST	0	0	0	0	0	0	0	0
Other resets	0	0	0	0	0	0	0	0

Bit	Name	Function
D[15..6]	Reserved	Write 0 when writing. 0 is returned after a read.
D[5]	DSIUINTR	DSIU interrupt 1 : Occurred 0 : Normal
D[4]	FIRINTR	FIR interrupt 1 : Occurred 0 : Normal
D[3]	TCLKINTR	TClock counter interrupt 1 : Occurred 0 : Normal
D[2]	HSPINTR	HSP interrupt 1 : Occurred 0 : Normal
D[1]	LEDINTR	LED interrupt 1 : Occurred 0 : Normal
D[0]	RTCL2INTR	RTCLong2 timer interrupt 1 : Occurred 0 : Normal

This register indicates when various interrupts occur in the VR4102 system.

14.2.16 GIUINTHREG (0x0B00 0202)

Bit	D15	D14	D13	D12	D11	D10	D9	D8
Name	INTS[31]	INTS[30]	INTS[29]	INTS[28]	INTS[27]	INTS[26]	INTS[25]	INTS[24]
R/W	R	R	R	R	R	R	R	R
RTCST	0	0	0	0	0	0	0	0
Other resets	0	0	0	0	0	0	0	0

Bit	D7	D6	D5	D4	D3	D2	D1	D0
Name	INTS[23]	INTS[22]	INTS[21]	INTS[20]	INTS[19]	INTS[18]	INTS[17]	INTS[16]
R/W	R	R	R	R	R	R	R	R
RTCST	0	0	0	0	0	0	0	0
Other resets	0	0	0	0	0	0	0	0

Bit	Name	Function
D[15..0]	INTS[31..16]	GPIO[31..16] pin interrupt 1 : Occurred 0 : Normal

This register indicates when various GIU-related interrupts occur.

14.2.17 FIRINTREG (0x0B00 0204)

Bit	D15	D14	D13	D12	D11	D10	D9	D8
Name	Reserved	Reserved	Reserved	Reserved	Reserved	Reserved	Reserved	Reserved
R/W	R	R	R	R	R	R	R	R
RTCRST	0	0	0	0	0	0	0	0
Other resets	0	0	0	0	0	0	0	0

Bit	D7	D6	D5	D4	D3	D2	D1	D0
Name	Reserved	Reserved	Reserved	FIRINT	FDPINT[4]	FDPINT[3]	FDPINT[2]	FDPINT[1]
R/W	R	R	R	R	R	R	R	R
RTCRST	0	0	0	0	0	0	0	0
Other resets	0	0	0	0	0	0	0	0

Bit	Name	Function
D[15..5]	Reserved	Write 0 when writing. 0 is returned after a read.
D[4]	FIRINT	Interrupt from FIR unit 1 : Occurred 0 : Normal
D[3]	FDPINT[4]	FIR DMA buffer (receive side) 2 page interrupt 1 : Occurred 0 : Normal
D[2]	FDPINT[3]	FIR DMA buffer (transmit side) 2 page interrupt 1 : Occurred 0 : Normal
D[1]	FDPINT[2]	FIR DMA buffer (receive side) 1 page interrupt 1 : Occurred 0 : Normal
D[0]	FDPINT[1]	FIR DMA buffer (transmit side) 1 page interrupt 1 : Occurred 0 : Normal

This register indicates when various FIR-related interrupts occur.

When FDPINT[4] or FDPINT[3] is set to 1, the VR4102 stops the DMA requests. When FDPINT[2] or FDPINT[1] is set to 1 during the FDPCNT bit of the DPCNTR register (0x0C00 004C) is set to 1 (DMA buffer 1 page interrupt is enabled), the VR4102 stops the DMA requests.

14.2.18 MSYSINT2REG (0x0B00 0206)

Bit	D15	D14	D13	D12	D11	D10	D9	D8
Name	Reserved	Reserved	Reserved	Reserved	Reserved	Reserved	Reserved	Reserved
R/W	R	R	R	R	R	R	R	R
RTCRST	0	0	0	0	0	0	0	0
Other resets	0	0	0	0	0	0	0	0

Bit	D7	D6	D5	D4	D3	D2	D1	D0
Name	Reserved	Reserved	DSIUINTR	FIRINTR	TCLKINTR	HSPINTR	LEDINTR	RTCL2INTR
R/W	R	R	R/W	R/W	R/W	R/W	R/W	R/W
RTCRST	0	0	0	0	0	0	0	0
Other resets	0	0	0	0	0	0	0	0

Bit	Name	Function
D[15..6]	Reserved	Write 0 when writing. 0 is returned after a read.
D[5]	DSIUINTR	DSIU interrupt enable 1 : Enable 0 : Prohibit
D[4]	FIRINTR	FIR interrupt enable 1 : Enable 0 : Prohibit
D[3]	TCLKINTR	TClock counter interrupt enable 1 : Enable 0 : Prohibit
D[2]	HSPINTR	HSP interrupt enable 1 : Enable 0 : Prohibit
D[1]	LEDINTR	LED interrupt enable 1 : Enable 0 : Prohibit
D[0]	RTCL2INTR	RTCLong2 timer interrupt enable 1 : Enable 0 : Prohibit

This register is used to mask various interrupts in the VR4102 system.

14.2.19 MGIUINTHREG (0x0B00 0208)

Bit	D15	D14	D13	D12	D11	D10	D9	D8
Name	INTS[31]	INTS[30]	INTS[29]	INTS[28]	INTS[27]	INTS[26]	INTS[25]	INTS[24]
R/W	R/W	R/W	R/W	R/W	R/W	R/W	R/W	R/W
RTCRST	0	0	0	0	0	0	0	0
Other resets	0	0	0	0	0	0	0	0

Bit	D7	D6	D5	D4	D3	D2	D1	D0
Name	INTS[23]	INTS[22]	INTS[21]	INTS[20]	INTS[19]	INTS[18]	INTS[17]	INTS[16]
R/W	R/W	R/W	R/W	R/W	R/W	R/W	R/W	R/W
RTCRST	0	0	0	0	0	0	0	0
Other resets	0	0	0	0	0	0	0	0

Bit	Name	Function
D[15..0]	INTS[31..16]	Enable GPIO[31..16] pin interrupt 1 : Enable 0 : Prohibit

This register is used to mask various GIU-related interrupts.

14.2.20 MFIRINTREG (0x0B00 020A)

Bit	D15	D14	D13	D12	D11	D10	D9	D8
Name	Reserved	Reserved	Reserved	Reserved	Reserved	Reserved	Reserved	Reserved
R/W	R	R	R	R	R	R	R	R
RTCRST	0	0	0	0	0	0	0	0
Other resets	0	0	0	0	0	0	0	0

Bit	D7	D6	D5	D4	D3	D2	D1	D0
Name	Reserved	Reserved	Reserved	FIRINT	FDPINT[4]	FDPINT[3]	FDPINT[2]	FDPINT[1]
R/W	R	R	R	R/W	R/W	R/W	R/W	R/W
RTCRST	0	0	0	0	0	0	0	0
Other resets	0	0	0	0	0	0	0	0

Bit	Name	Function
D[15..5]	Reserved	Write 0 when writing. 0 is returned after a read.
D4	FIRINT	FIR unit interrupt enable 1 : Enable 0 : Prohibit
D[3]	FDPINT[4]	FIR DMA buffer 2 page interrupt (receive side) enable 1 : Enable 0 : Prohibit
D[2]	FDPINT[3]	FIR DMA buffer 2 page interrupt (transmit side) enable 1 : Enable 0 : Prohibit
D[1]	FDPINT[2]	FIR DMA buffer 1 page interrupt (receive side) enable 1 : Enable 0 : Prohibit
D[0]	FDPINT[1]	FIR DMA buffer 1 page interrupt (transmit side) enable 1 : Enable 0 : Prohibit

This register is used to mask various FIR-related interrupts.

14.3 NOTES FOR REGISTER SETTING

There is no register setting flow in relation to the ICU.

With regard to the interrupt mask registers, the initial setting is “initial = 0= mask” after start up. Therefore, enough masks must be cleared to provide sufficient interrupts for the CPU’s start-up processing. This is always necessary when battint_intr = NMI.

The initial setting for battint_intr is “initial = 0 = NMI”. A “1” must be written to the register to switch this setting to Int0.

soft_intr is a software interrupt that is output to Int0 by setting 1 to the SOFTINTREG register. Writing a “0” clears the interrupt.

[MEMO]

CHAPTER 15 PMU (POWER MANAGEMENT UNIT)

This chapter describes the PMU's operation and register settings.

15.1 GENERAL

The PMU performs power management within the VR4102 and controls the power supply throughout the system which includes the VR4102.

- Reset control
- Shutdown control
- Power-on control
- Low-power mode control

The PMU also performs settings to use the GPIO[12:9], GPIO[3:0] signals as a start-up factor.

15.1.1 Reset Control

The operations of the RTC, peripheral units, CPU core, and PMUINTREG bit settings during a reset are listed below.

Table 15-1. Bit Operations during Reset

Reset type	RTC	Peripheral units	CPU core	PMUINTREG
RTC reset	Reset	Reset	Cold reset	RTCST=1
RSTSW reset	Active	Reset	Cold reset	RSTSW=1

(1) RTC reset

When the RTCRST# signal is asserted, the PMU resets all peripheral units including the RTC unit. It also asserts the ccoldresetb and creset signals (internal) and resets the CPU core.

In addition, the RTCRST bit in PMUINTREG is set (to "1"). After the CPU is restarted, the RTCRST bit must be checked and cleared (to "0") by software.

(2) RSTSW reset

When the RSTSW# signal is asserted, the PMU resets all peripheral units except for RTC and PMU. Next, it asserts the ccoldresetb and creset signals (internal) and resets the CPU core.

In addition, the RSTSW bit in PMUINTREG is set (to "1"). After the CPU is restarted, the RSTSW bit must be checked and cleared (to "0") by software.

15.1.2 Shutdown Control

The operations of the RTC, peripheral units, CPU core, and PMUINTREG bit settings during a reset are listed below.

Table 15-2. Bit Operations during Shutdown

Shutdown type	RTC	Peripheral units	CPU core	PMUINTREG
HAL timer shutdown	Active	Reset	Cold reset	HALTIMERRST=1
Deadman's SW shutdown	Active	Reset	Cold reset	TIMOUTRST=1
Software shutdown	Active	Reset	Cold reset	-
Battery low shutdown	Active	Reset	Cold reset	BATTINH=1
Battery lock cancel shutdown	Active	Reset	Cold reset	-

(1) HAL Timer Shutdown

After the CPU is activated (following the mode change from Shutdown or Hibernate mode to Fullspeed mode), the software must write "1" to PMUCNTREG's HALTIMERRST bit within about four seconds to clear the HAL timer.

If the HAL timer is not reset within about four seconds after the CPU is activated, the PMU resets all peripheral units except for RTC and PMU. Next, it asserts the ccoldresetb and creset signals (internal) and resets the CPU core.

In addition, the TIMOUTRST bit in PMUINTREG is set (to "1"). After the CPU is restarted, the TIMOUTRST bit must be checked and cleared (to "0") by software.

(2) Deadman's SW Shutdown

When the Deadman's SW function is enabled, the software must write "1" to DSUCLRREG's DSWCLR bit each time a Deadman's SW setting is made, to clear the Deadman's SW counter (for details, see Chapter 17).

If the Deadman's SW counter is not cleared during a Deadman's SW setting, the PMU resets all peripheral units except for RTC and PMU. Next, it asserts the ccoldresetb and creset signals (internal) and resets the CPU core.

In addition, the DMSRST bit in PMUINTREG is set (to "1"). After the CPU is restarted, the DMSRST bit must be checked and cleared (to "0") by software.

(3) Software Shutdown

When the HIBERNATE instruction is executed, the PMU checks for currently pending interrupts. If there are no pending interrupts, it stops the CPU clock. It then resets all peripheral units except for RTC and PMU.

The PMU register contents do not change.

15.1.3 Power-on Control

The causes of CPU activation (mode change from shutdown mode or Hibernate mode to Fullspeed mode) are called power-on factors. There are twelve power-on factors: a power switch interrupt (POWER), eight types of GPIO activation interrupts (GPIO[12:9], GPIO[3..0]), a DCD interrupt (DCD#), a touch panel interrupt, and an alarm interrupt.

Battery low detection is a factor that prevents CPU activation.

(1) Activation via Power Switch Interrupt

When the POWER signal is asserted, the PMU asserts the POWERON signal and provides external notification that the CPU is being activated. After asserting the POWERON signal, the PMU checks the BATTINH signal and then de-asserts the POWERON signal.

If the BATTINH/BATTINT# signal is high ("1"), the PMU cancels peripheral unit reset, then starts the Cold Reset sequence to activate the CPU core.

If the BATTINH/BATTINT# signal is low ("0"), the PMU sets "1" to PMUINTREG's BATTINH bit and then performs another shutdown. After the CPU is restarted, the BATTINH bit must be checked and cleared (to "0") by software.

Figure 15-1. Activation via Power Switch Interrupt (BATTINH/BATTINT# = 1)

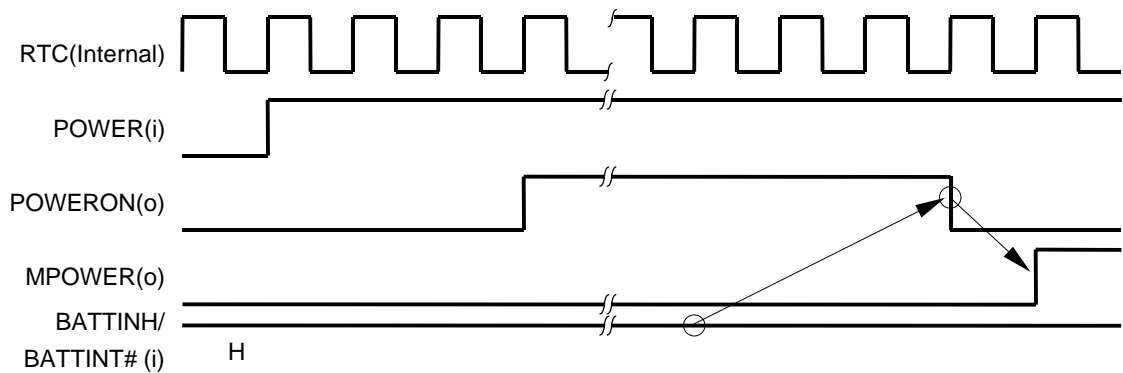
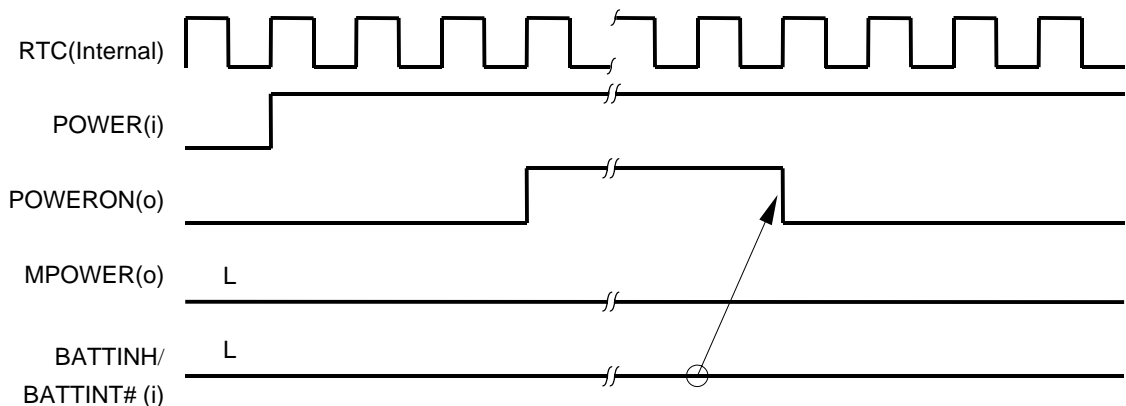

Figure 15-2. Activation via Power Switch Interrupt (BATTINH/BATTINT# = 0)



(2) Activation via GPIO Activation Interrupt

When the GPIO[12:9], GPIO[3..0] signal is asserted, the PMU checks the GPIO[12:9], GPIO[3..0]'s activation interrupt enable bit. If GPIO[12:9], GPIO[3..0] activation interrupts are enabled, the PMU asserts the POWERON signal and provides external notification that the CPU is being activated (since the GPIO[12:9], GPIO[2..0] activation enable interrupt bit is cleared after an RTC is reset, the GPIO[12:9], GPIO[2..0] signal cannot be used for activation immediately after an RTC reset. However, activation can occur at the falling edge of the GPIO[3] signal immediately after an RTC reset for GPIO[3] only). The PMU asserts the POWERON signal, then checks the BATTINH/BATTINT# signal and de-asserts the POWERON signal.

When the BATTINH/BATTINT# signal is high ("1"), the PMU cancels peripheral unit reset, then starts the Cold Reset sequence to activate the CPU core.

When the BATTINH/BATTINT# signal is low ("0"), the PMU sets "1" to PMUINTREG's BATTINH bit and then performs another shutdown. After the CPU is restarted, the BATTINH bit must be checked and cleared (to "0") by software.

The CPU sets "1" to the corresponding GPIOINTR bit in the PMUINTREG regardless of whether activation succeeds or fails.

Figure 15-3. Activation via GPIO Activation Interrupt (BATTINH/BATTINT# = 1)

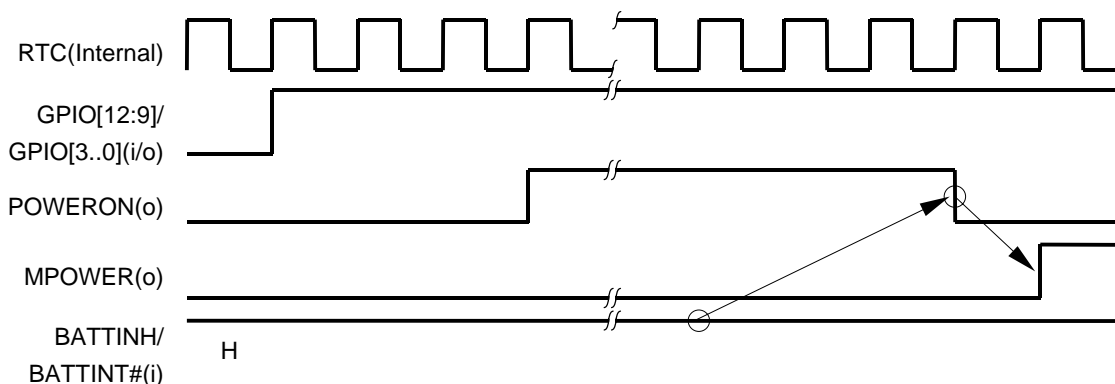
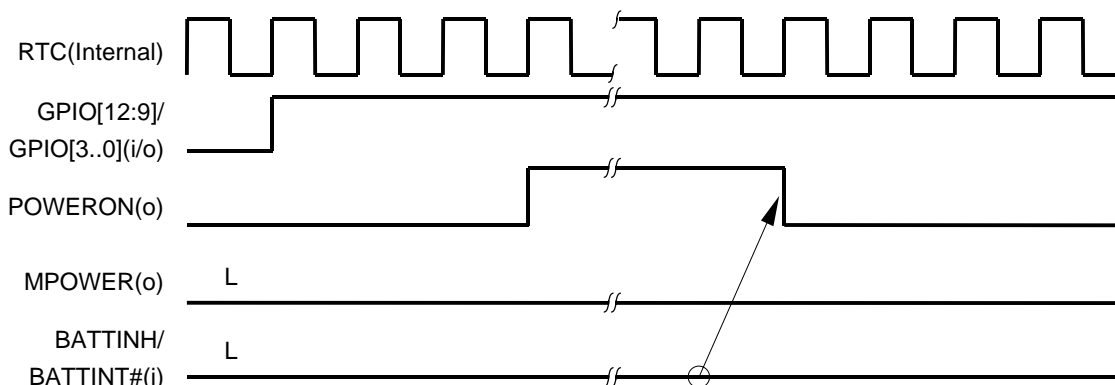

Figure 15-4. Activation via GPIO Activation Interrupt (BATTINH/BATTINT# = 0)



(3) Activation via DCD Interrupt

When the DCD# signal is asserted, the PMU asserts the POWERON signal and provides external notification that the CPU is being activated. After asserting the POWERON signal, the PMU checks the BATTINH/BATTINT# signal and then de-asserts the POWERON signal.

If the BATTINH/BATTINT# signal is high (“1”), the PMU cancels peripheral unit reset, then starts the Cold Reset sequence to activate the CPU core.

If the BATTINH/BATTINT# signal is low (“0”), the PMU sets “1” to PMUINTREG’s BATTINH bit and then performs another shutdown. After the CPU is restarted, the BATTINH bit must be checked and cleared (to “0”) by software.

The PMUINTREG’s DCDST bit does not indicate whether a DCD interrupt has occurred but instead reflects the current status of the DCD# pin.

www.DataSheet4U.com

Caution While POWERON is active, the PMU cannot recognize changes in the DCD# signal. If the DCD# state when POWERON is active is different from the DCD# state when POWERON is inactive, the change in the DCD# signal is detected only after POWERON is inactive. However, if the DCD# state when POWERON is active is the same as the DCD# state when POWERON is inactive, any changes in the DCD# signal that occur while POWERON is active are not detected.

Figure 15-5. Activation via DCD Interrupt (BATTINH/BATTINT# = 1)

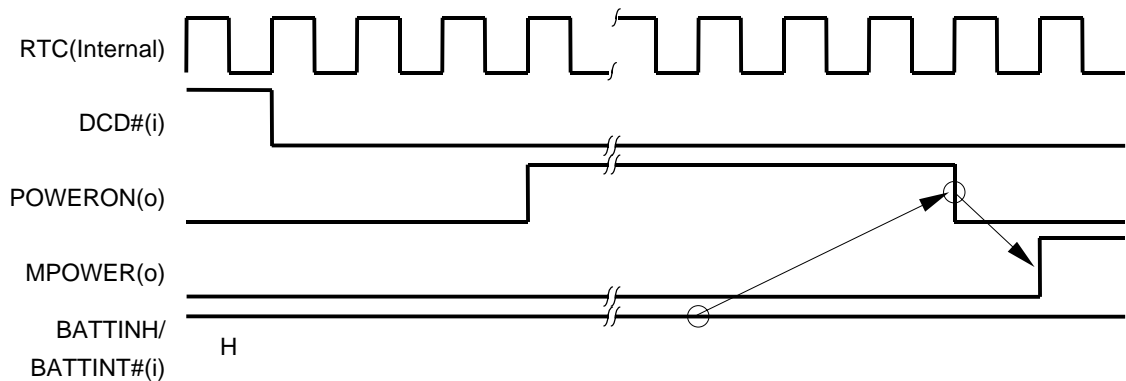
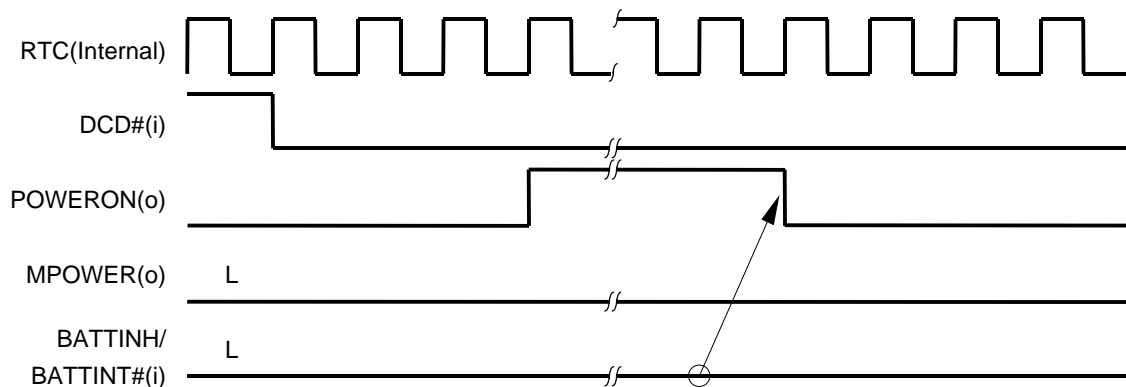

Figure 15-6. Activation via DCD Interrupt (BATTINH/BATTINT# = 0)



(4) Activation via Alarm Interrupt

When the alarm interrupt (alarm_intr) signal is asserted, the PMU asserts the POWERON signal and provides external notification that the CPU is being activated. After asserting the POWERON signal, the PMU checks the BATTINH/BATTINT# signal and then de-asserts the POWERON signal.

If the BATTINH/BATTINT# signal is high ("1"), the PMU cancels peripheral unit reset, then starts the Cold Reset sequence to activate the CPU core.

If the BATTINH/BATTINT# signal is low ("0"), the PMU sets "1" to PMUINTREG's BATTINH bit and then performs another shutdown. After the CPU is restarted, the BATTINH bit must be checked and cleared (to "0") by software.

Figure 15-7. Activation via Alarm Interrupt (BATTINH/BATTINT# = 1)

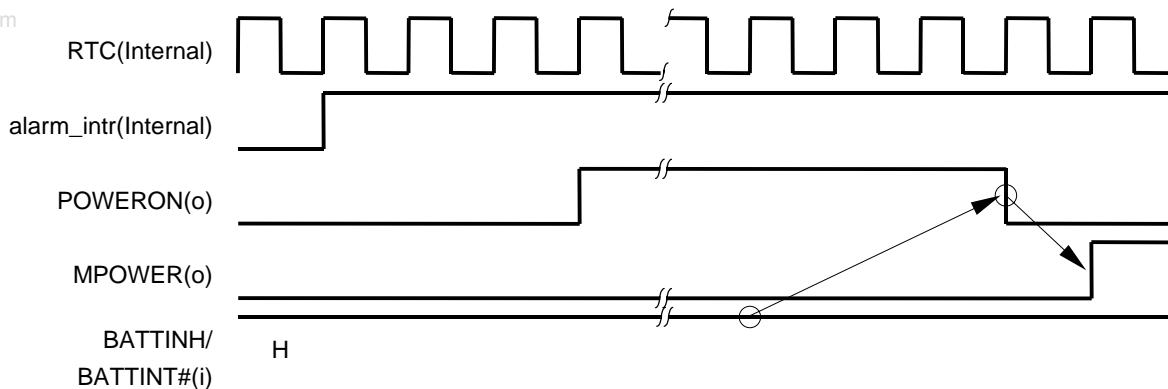
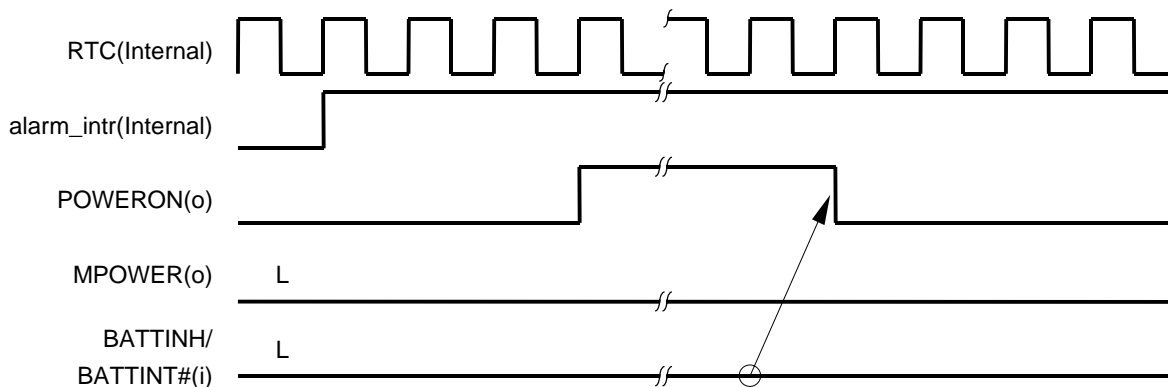

Figure 15-8. Activation via Alarm Interrupt (BATTINH/BATTINT# = 0)



15.1.4 Power Mode

The VR4102 supports the following four power modes.

- ✧ Fullspeed mode
- ✧ Standby mode
- ✧ Suspend mode
- ✧ Hibernate mode

Figure 15-9 illustrates the transition between the different power modes.

To set Standby, Suspend, or Hibernate mode from Fullspeed mode, execute a STANDBY, SUSPEND, or HIBERNATE instruction respectively. To set Fullspeed mode from Standby, Suspend, or Hibernate mode, generate an interrupt or perform any reset.

Table 15-3 outlines the power modes.

Figure 15-9. Power Mode State Transition

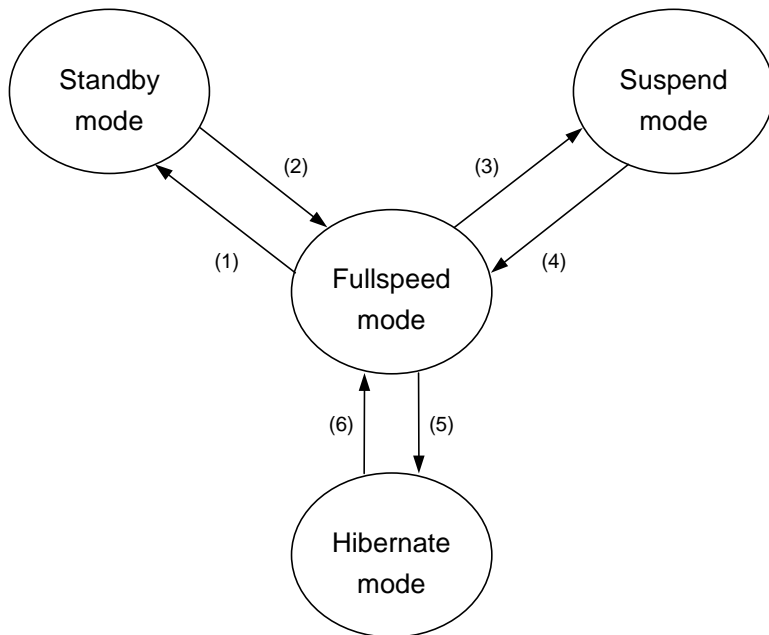

www.DataSheet4U.com

(1)	(2)	(3)	(4)	(5)	(6)
STANDBY instruction & pipeline flash & SysAD idle & PClock high	All interrupts	SUSPEND instruction & pipeline flash & SysAD idle & PClock high & TClock high & DRAM self refresh	BatteryInt POWERON RTCRST Alarm KeyTouch PenTouch GPIO[3..0] GPIO[14..9] DCD# RTCLong	HIBERNATE instruction & pipeline flash & SysAD idle & PClock high & TClock high & MasterOut high & DRAM self refresh	POWERON Alarm DCD# GPIO[3..0] GPIO[12:9]

Table 15-3. Power Mode

Mode	Internal peripheral unit				CPU core
	RTC	ICU	DCU	others	
Fullspeed	On	On	On	Selectable ^{Note}	On
Standby	On	On	On	Selectable ^{Note}	Off
Suspend	On	On	Off	Off	Off
Hibernate	On	Off	Off	Off	Off
Off	Off	Off	Off	Off	Off

Note See Chapter 13 for details.

(1) Fullspeed Mode

In Fullspeed mode, all internal clocks and the bus clock operate. In this mode, all the functions of the VR4102 can be executed.

(2) Standby Mode

In Standby mode, all internal clocks, other than those provided to the internal peripheral units and the internal timer/interrupt unit of the CPU core, are fixed to high level.

To switch to Standby mode from Fullspeed mode, first execute the STANDBY instruction. The VR4102 waits until the SysAD bus (internal) enters idle status after the completion of the WB stage of the STANDBY instruction. Then, the internal clock is shut down, and the pipeline stops. PLL, timer/interrupt clock, internal bus clocks (TClock, MasterOut), and RTC continue to operate.

In Standby mode, the processor returns to Fullspeed mode when an interrupt occurs. At this time, the contents of bits indicating the states of pins in the peripheral unit's registers are undefined. The contents of other fields are retained.

(3) Suspend Mode

In Suspend mode, all internal clocks (including TClock) other than those supplied to the RTC/ICU/PMU internal peripheral units and the internal timer/interrupt unit of the CPU core are fixed to high level.

To switch to Suspend mode from Fullspeed mode, first execute the SUSPEND instruction. The VR4102 waits until the SysAD bus (internal) enters idle status after the completion of the WB stage of the SUSPEND instruction, DRAM has entered self-refresh mode, and the MPOWER pin has been made inactive. Then, the internal clocks (including TClock) are shut down, and the pipeline stops. PLL, timer interrupt clock, MasterOut, and RTC continue to operate.

If the SUSPEND instruction is executed during DMA transfer, the DRAM transfer is suspended, and operation is undefined.

In Suspend mode, the processor returns to Fullspeed mode when an interrupt request from the peripheral units or any resets occur. At this time, the contents of bits indicating the states of pins in the peripheral unit's registers are undefined. The contents of other fields are retained.

(4) Hibernate Mode

In Hibernate mode, all the clocks supplied to internal peripheral units other than RTC/ICU/PMU and to the CPU core are fixed to high level.

To switch to Hibernate mode from Fullspeed mode, first execute the HIBERNATE instruction. The VR4102 waits until the SysAD bus (internal) enters idle status after the completion of the WB stage of the HIBERNATE instruction, DRAM has entered self-refresh mode, and the MPOWER pin has been made inactive. Then, the internal clocks (including TClock and MasterOut) are shut down, and the pipeline stops. PLL also stops, but RTC continue to operate.

In Hibernate mode, the processor returns to Fullspeed mode when it is alarmed from the RTC, the power-on switch is pressed, or DCD# pin is asserted. At this time, the contents of bits indicating the states of pins in the peripheral unit's registers and caches in the CPU core are undefined. The contents of other fields are retained.

www.DataSheet4U.com

15.2 REGISTER SET

The PMU registers are listed below.

Table 15-4. PMU Registers

Address	R/W	Register symbols	Function
0x0B00 00A0	R/W	PMUINTREG	PMU Interrupt/Status Register
0x0B00 00A2	R/W	PMUCNTREG	PMU Control Register
0x0B00 00A4	R/W	PMUINT2REG	PMU Interrupt Register 2
0x0B00 00A6	R/W	PMUCNT2REG	PMU Control Register 2

Each register is described in detail below.

15.2.1 PMUINTREG (0x0B00 00A0)

(1/2)

Bit	D15	D14	D13	D12	D11	D10	D9	D8
Name	GPIO3INTR	GPIO2INTR	GPIO1INTR	GPIO0INTR	Reserved	DCDST	RTCINTR	BATTINH
R/W	R/W	R/W	R/W	R/W	R	R	R/W	R/W
RTCRST	0	0	0	0	0	0	0	0
Other resets	0	0	0	0	0	0	0	0

Bit	D7	D6	D5	D4	D3	D2	D1	D0
Name	BATTLOCK	CARDLOCK	TIMOUTRST	RTCRST	RSTSW	DMSRST	BATTINTR	POWERSW INTR
R/W	R/W	R/W	R/W	R/W	R/W	R/W	R/W	R/W
RTCRST	0	0	0	1	0	0	0	0
Other resets	0	0	0	0	0	0	0	0

Bit	Name	Function
D[15]	GPIO3INTR	GPIO[3] activation interrupt detection. Cleared to 0 when 1 is written. 1 : Detected 0 : Not detected
D[14]	GPIO2INTR	GPIO[2] activation interrupt detection. Cleared to 0 when 1 is written. 1 : Detected 0 : Not detected
D[13]	GPIO1INTR	GPIO[1] activation interrupt detection. Cleared to 0 when 1 is written. 1 : Detected 0 : Not detected
D[12]	GPIO0INTR	GPIO[0] activation interrupt detection. Cleared to 0 when 1 is written. 1 : Detected 0 : Not detected
D[11]	Reserved	Write 0 when writing. 0 is returned after a read.
D[10]	DCDST	DCD# pin state. 1 : High 0 : Low
D[9]	RTCINTR	RTC alarm interrupt detection. Cleared to 0 when 1 is written. 1 : Detected 0 : Not detected
D[8]	BATTINH	Battery low detection during activation. Cleared to 0 when 1 is written. 1 : Detected 0 : Not detected

Bit	Name	Function
D[7]	BATTLOCK	Battery lock interrupt detection ^{Note} 1 : Detected 0 : Not detected
D[6]	CARDLOCK	PCMCIA card lock interrupt detection ^{Note} 1 : Detected 0 : Not detected
D[5]	TIMOUTRST	HAL timer reset detection. Cleared to 0 when 1 is written. 1 : Detected 0 : Not detected
D[4]	RTCST	RTC reset detection. Cleared to 0 when 1 is written. 1 : Detected 0 : Not detected
D[3]	RSTSW	RESET switch interrupt detection. Cleared to 0 when 1 is written. 1 : Detected 0 : Not detected
D[2]	DMSRST	Deadman's switch interrupt detection. Cleared to 0 when 1 is written. 1 : Detected 0 : Not detected
D[1]	BATTINTR	Battery low detection during normal operation. Cleared to 0 when 1 is written. 1 : Detected 0 : Not detected
D[0]	POWERSWINTR	POWER switch interrupt detection. Cleared to 0 when 1 is written. 1 : Detected 0 : Not detected

Note These bits are used by software. These are never set by hardware, and their settings never affect hardware.

This register is used to set whether the CPU detects a power-on factor and reset. It also indicates the status of the DCD# pin.

15.2.2 PMUCNTREG (0x0B00 00A2)

(1/2)

Bit	D15	D14	D13	D12	D11	D10	D9	D8
Name	GPIO3MSK	GPIO2MSK	GPIO1MSK	GPIO0MSK	GPIO3TRG	GPIO2TRG	GPIO1TRG	GPIO0TRG
R/W	R/W	R/W	R/W	R/W	R/W	R/W	R/W	R/W
RTCRST	1	0	0	0	1	0	0	0
Other resets	Note	Note	Note	Note	Note	Note	Note	Note

Bit	D7	D6	D5	D4	D3	D2	D1	D0
Name	STANDBY	Reserved	Reserved	Reserved	Reserved	HALTIMER RST	Reserved	Reserved
R/W	R/W	R	R	R	R	R/W	R	R
RTCRST	0	0	0	0	0	0	1	0
Other resets	0	0	0	0	0	0	1	0

Bit	Name	Function
D[15]	GPIO3MSK	GPIO[3] activation enable 1: Enable 0: Prohibit
D[14]	GPIO2MSK	GPIO[2] activation enable 1: Enable 0: Prohibit
D[13]	GPIO1MSK	GPIO[1] activation enable 1: Enable 0: Prohibit
D[12]	GPIO0MSK	GPIO[0] activation enable 1: Enable 0: Prohibit
D[11]	GPIO3TRG	GPIO[3] activation interrupt type 1: Falling edge detection 0: Rising edge detection
D[10]	GPIO2TRG	GPIO[2] activation interrupt type 1: Falling edge detection 0: Rising edge detection
D[9]	GPIO1TRG	GPIO[1] activation interrupt type 1: Falling edge detection 0: Rising edge detection
D[8]	GPIO0TRG	GPIO[0] activation interrupt type 1: Falling edge detection 0: Rising edge detection
D[7]	STANDBY	Standby mode setting. This setting is performed only for software, and does not affect hardware in any way. 1: Standby mode 0: Normal mode

Note Holds the value before reset

Bit	Name	Function
D[6..3]	Reserved	Write 0 when writing. 0 is returned after a read.
D[2]	HALTIMERRST	HAL timer reset 1 : Reset 0 : Set
D[1]	Reserved	Write 1 when writing. 1 is returned after a read.
D[0]	Reserved	Write 0 when writing. 0 is returned after a read.

This register is used to set CPU shutdown and overall system management operations.

The HALTIMERRST bit must be reset within about four seconds of activation. Resetting of the HALTIMERRST bit indicates that the VR4102 itself has been activated normally. If the HALTIMERRST bit is not reset within about four seconds of activation, program execution is regarded as abnormal (possibly due to a runaway) and an automatic shutdown is performed.

The GPIO[3..0]MSK bits are used to set enable/prohibit for activation from Hibernate mode when the corresponding interrupt (GPIO[3..0]) occurs. The GPIO3MSK bit is set to 1 by RTCRST, and the other bits are cleared to "0" (prohibit). Accordingly, the GPIO[2..0] cannot be used for activation immediately after an RTCRST reset. The GPIO activation interrupt is valid only when the CPU's operation mode is Hibernate mode.

15.2.3 PMUINT2REG (0x0B00 00A4)

Bit	D15	D14	D13	D12	D11	D10	D9	D8
Name	GPIO12INTR	GPIO11INTR	GPIO10INTR	GPIO9INTR	Reserved	Reserved	Reserved	Reserved
R/W	R/W	R/W	R/W	R/W	R	R	R	R
RTCRST	0	0	0	0	0	0	0	0
Other resets	0	0	0	0	0	0	0	0

Bit	D7	D6	D5	D4	D3	D2	D1	D0
Name	Reserved	Reserved	Reserved	Reserved	Reserved	Reserved	Reserved	Reserved
R/W	R	R	R	R	R	R	R	R
RTCRST	0	0	0	0	0	0	0	0
Other resets	0	0	0	0	0	0	0	0

Bit	Name	Function
D[15]	GPIO12INTR	GPIO[12] activation interrupt request detection. Cleared to 0 when 1 is written. 1 : Detected 0 : Not detected
D[14]	GPIO11INTR	GPIO[11] activation interrupt request detection. Cleared to 0 when 1 is written. 1 : Detected 0 : Not detected
D[13]	GPIO10INTR	GPIO[10] activation interrupt request detection. Cleared to 0 when 1 is written. 1 : Detected 0 : Not detected
D[12]	GPIO9INTR	GPIO[9] activation interrupt request detection. Cleared to 0 when 1 is written. 1 : Detected 0 : Not detected
D[11:0]	Reserved	Write 0 when writing. 0 is returned after a read.

This register is used to specify whether the GPIO[12:9] interrupt is detected as a power-on factor.

15.2.4 PMUCNT2REG (0x0B00 00A6)

Bit	D15	D14	D13	D12	D11	D10	D9	D8
Name	GPIO12MSK	GPIO11MSK	GPIO10MSK	GPIO9MSK	GPIO12TRG	GPIO11TRG	GPIO10TRG	GPIO9TRG
R/W	R/W	R/W	R/W	R/W	R/W	R/W	R/W	R/W
RTCRST	0	0	0	0	0	0	0	0
Other resets	0	0	0	0	0	0	0	0

Bit	D7	D6	D5	D4	D3	D2	D1	D0
Name	Reserved	Reserved	Reserved	Reserved	Reserved	Reserved	Reserved	Reserved
R/W	R	R	R	R	R	R	R	R
RTCRST	0	0	0	0	0	0	0	0
Other resets	0	0	0	0	0	0	0	0

Bit	Name	Function
D[15]	GPIO12MSK	GPIO[12] activation enable 1: Enable 0: Prohibit
D[14]	GPIO11MSK	GPIO[11] activation enable 1: Enable 0: Prohibit
D[13]	GPIO10MSK	GPIO[10] activation enable 1: Enable 0: Prohibit
D[12]	GPIO9MSK	GPIO[9] activation enable 1: Enable 0: Prohibit
D[11]	GPIO12TRG	GPIO[12] activation interrupt type 1: Falling edge detection 0: Rising edge detection
D[10]	GPIO11TRG	GPIO[11] activation interrupt type 1: Falling edge detection 0: Rising edge detection
D[9]	GPIO10TRG	GPIO[11] activation interrupt type 1: Falling edge detection 0: Rising edge detection
D[8]	GPIO9TRG	GPIO[9] activation interrupt type 1: Falling edge detection 0: Rising edge detection
D[7:0]	Reserved	Write 0 when writing. 0 is returned after a read.

This register is used to specify the settings for activation via GPIO [12:9] interrupts.

The GPIO activation interrupt is valid only when the CPU's operation mode is Hibernate mode.

[MEMO]

www.DataSheet4U.com

CHAPTER 16 RTC (REALTIME CLOCK UNIT)

This chapter describes the RTC unit's operations and register settings.

16.1 GENERAL

The RTC unit has a total of four timers, including the following three types.

- **RTCLong ...** This is a 24-bit programmable counter that counts down using 32.768-kHz cycles. Cycle interrupts occur for up to 512 seconds. The RTC unit includes two RTCLong timers.
- **TClockCount ...** This is a 25-bit programmable counter that counts down using TClock cycles. Cycle interrupts occur for up to 1 to 2 seconds. This counter is used for performance evaluation.
- **ElapsedTime ...** This is a 48-bit up counter that counts up using 32.768-kHz cycles. It counts up to 272 years before returning to zero. It includes 48-bit comparators (ECMPHREG, ECMPREG, and ECMPMREG) and 48-bit alarm time registers (ETIMELREG, ETIMEMREG, and ETIMEHREG) to enable interrupts to occur at specified times.

16.2 REGISTER SET

The RTC registers are listed below.

Table 16-1. RTC Registers

Address	R/W	Register Symbols	Function
0x0B00 00C0	R/W	ETIMELREG	Elapsed Time L Register
0x0B00 00C2	R/W	ETIMEMREG	Elapsed Time M Register
0x0B00 00C4	R/W	ETIMEHREG	Elapsed Time H Register
0x0B00 00C8	R/W	ECMPLREG	Elapsed Compare L Register
0x0B00 00CA	R/W	ECMPMREG	Elapsed Compare M Register
0x0B00 00CC	R/W	ECMPHREG	Elapsed Compare H Register
0x0B00 00D0	R/W	RTCL1LREG	RTC Long 1 L Register
0x0B00 00D2	R/W	RTCL1HREG	RTC Long 1 H Register
0x0B00 00D4	R	RTCL1CNTLREG	RTC Long 1 Count L Register
0x0B00 00D6	R	RTCL1CNTHREG	RTC Long 1 Count H Register
0x0B00 00D8	R/W	RTCL2LREG	RTC Long 2 L Register
0x0B00 00DA	R/W	RTCL2HREG	RTC Long 2 H Register
0x0B00 00DC	R	RTCL2CNTLREG	RTC Long 2 Count L Register
0x0B00 00DE	R	RTCL2CNTHREG	RTC Long 2 Count H Register
0x0B00 01C0	R/W	TCLKLREG	TCLK L Register
0x0B00 01C2	R/W	TCLKHREG	TCLK H Register
0x0B00 01C4	R	TCLKCNTLREG	TCLK Count L Register
0x0B00 01C6	R	TCLKCNTHREG	TCLK Count H Register
0x0B00 01DE	R/W	RTCINTREG	RTC Interrupt Register

Each register is described in detail below.

16.2.1 Elapsed Time Registers

(1) ETIMELREG (0x0B00 00C0)

Bit	D15	D14	D13	D12	D11	D10	D9	D8
Name	ETIME[15]	ETIME[14]	ETIME[13]	ETIME[12]	ETIME[11]	ETIME[10]	ETIME[9]	ETIME[8]
R/W	R/W	R/W	R/W	R/W	R/W	R/W	R/W	R/W
RTCRST	0	0	0	0	0	0	0	0
Other resets	Note	Note	Note	Note	Note	Note	Note	Note

Bit	D7	D6	D5	D4	D3	D2	D1	D0
Name	ETIME[7]	ETIME[6]	ETIME[5]	ETIME[4]	ETIME[3]	ETIME[2]	ETIME[1]	ETIME[0]
R/W	R/W	R/W	R/W	R/W	R/W	R/W	R/W	R/W
RTCRST	0	0	0	0	0	0	0	0
Other resets	Note	Note	Note	Note	Note	Note	Note	Note

Bit	Name	Function
D[15:0]	ETIME[15:0]	ElapsedTime bit [15:0]

Note Continues counting

(2) ETIMEMREG (0x0B00 00C2)

Bit	D15	D14	D13	D12	D11	D10	D9	D8
Name	ETIME[31]	ETIME[30]	ETIME[29]	ETIME[28]	ETIME[27]	ETIME[26]	ETIME[25]	ETIME[24]
R/W	R/W	R/W	R/W	R/W	R/W	R/W	R/W	R/W
RTCRST	0	0	0	0	0	0	0	0
Other resets	Note	Note	Note	Note	Note	Note	Note	Note

Bit	D7	D6	D5	D4	D3	D2	D1	D0
Name	ETIME[23]	ETIME[22]	ETIME[21]	ETIME[20]	ETIME[19]	ETIME[18]	ETIME[17]	ETIME[16]
R/W	R/W	R/W	R/W	R/W	R/W	R/W	R/W	R/W
RTCRST	0	0	0	0	0	0	0	0
Other resets	Note	Note	Note	Note	Note	Note	Note	Note

Bit	Name	Function
D[15:0]	ETIME[31:16]	ElapsedTime bit [31:16]

Note Continues counting

(3) ETIMEHREG (0x0B00 00C4)

Bit	D15	D14	D13	D12	D11	D10	D9	D8
Name	ETIME[47]	ETIME[46]	ETIME[45]	ETIME[44]	ETIME[43]	ETIME[42]	ETIME[41]	ETIME[40]
R/W	R/W	R/W	R/W	R/W	R/W	R/W	R/W	R/W
RTCRST	0	0	0	0	0	0	0	0
Other resets	Note	Note	Note	Note	Note	Note	Note	Note

Bit	D7	D6	D5	D4	D3	D2	D1	D0
Name	ETIME[39]	ETIME[38]	ETIME[37]	ETIME[36]	ETIME[35]	ETIME[34]	ETIME[33]	ETIME[32]
R/W	R/W	R/W	R/W	R/W	R/W	R/W	R/W	R/W
RTCRST	0	0	0	0	0	0	0	0
Other resets	Note	Note	Note	Note	Note	Note	Note	Note

Bit	Name	Function
D[15:0]	ETIME[47:32]	ElapsedTime bit [47:32]

Note Continues counting

These registers indicate the elapsed timer's value. They count up using a 32.768-kHz cycle and when a match occurs with the elapsed compare registers, an alarm (elapsed time interrupt) occurs (and the count-up continues). A write operation is valid once values have been written to all registers (ETIMELREG, ETIMEMREG, and ETIMEHREG).

16.2.2 Elapsed Time Compare Registers

(1) ECMPREG (0x0B00 00C8)

Bit	D15	D14	D13	D12	D11	D10	D9	D8
Name	ECMP[15]	ECMP[14]	ECMP[13]	ECMP[12]	ECMP[11]	ECMP[10]	ECMP[9]	ECMP[8]
R/W	R/W	R/W	R/W	R/W	R/W	R/W	R/W	R/W
RTCRST	0	0	0	0	0	0	0	0
Other resets	Note	Note	Note	Note	Note	Note	Note	Note

Bit	D7	D6	D5	D4	D3	D2	D1	D0
Name	ECMP[7]	ECMP[6]	ECMP[5]	ECMP[4]	ECMP[3]	ECMP[2]	ECMP[1]	ECMP[0]
R/W	R/W	R/W	R/W	R/W	R/W	R/W	R/W	R/W
RTCRST	0	0	0	0	0	0	0	0
Other resets	Note	Note	Note	Note	Note	Note	Note	Note

Bit	Name	Function
D[15:0]	ECMP[15:0]	Value to be compared with ElapsedTime bit [15:0]

Note Previous value is retained

(2) ECMPMREG (0x0B00 00CA)

Bit	D15	D14	D13	D12	D11	D10	D9	D8
Name	ECMP[31]	ECMP[30]	ECMP[29]	ECMP[28]	ECMP[27]	ECMP[26]	ECMP[25]	ECMP[24]
R/W	R/W	R/W	R/W	R/W	R/W	R/W	R/W	R/W
RTCRST	0	0	0	0	0	0	0	0
Other resets	Note	Note	Note	Note	Note	Note	Note	Note

Bit	D7	D6	D5	D4	D3	D2	D1	D0
Name	ECMP[23]	ECMP[22]	ECMP[21]	ECMP[20]	ECMP[19]	ECMP[18]	ECMP[17]	ECMP[16]
R/W	R/W	R/W	R/W	R/W	R/W	R/W	R/W	R/W
RTCRST	0	0	0	0	0	0	0	0
Other resets	Note	Note	Note	Note	Note	Note	Note	Note

Bit	Name	Function
D[15:0]	ECMP[31:16]	Value to be compared with ElapsedTime bit [31:16]

Note Previous value is retained

(3) ECMPHREG (0x0B00 00CC)

Bit	D15	D14	D13	D12	D11	D10	D9	D8
Name	ECMP[47]	ECMP[46]	ECMP[45]	ECMP[44]	ECMP[43]	ECMP[42]	ECMP[41]	ECMP[40]
R/W	R/W	R/W	R/W	R/W	R/W	R/W	R/W	R/W
RTCRST	0	0	0	0	0	0	0	0
Other resets	Note	Note	Note	Note	Note	Note	Note	Note

Bit	D7	D6	D5	D4	D3	D2	D1	D0
Name	ECMP[39]	ECMP[38]	ECMP[37]	ECMP[36]	ECMP[35]	ECMP[34]	ECMP[33]	ECMP[32]
R/W	R/W	R/W	R/W	R/W	R/W	R/W	R/W	R/W
RTCRST	0	0	0	0	0	0	0	0
Other resets	Note	Note	Note	Note	Note	Note	Note	Note

Bit	Name	Function
D[15:0]	ECMP[47:32]	Value to be compared with ElapsedTime bit [47:32]

Note Previous value is retained

Use these registers to set the values to be compared with values in the elapsed time registers.

16.2.3 RTC Long 1 Registers

(1) RTCL1LREG (0x0B00 00D0)

Bit	D15	D14	D13	D12	D11	D10	D9	D8
Name	RTCL1P[15]	RTCL1P[14]	RTCL1P[13]	RTCL1P[12]	RTCL1P[11]	RTCL1P[10]	RTCL1P[9]	RTCL1P[8]
R/W	R/W	R/W	R/W	R/W	R/W	R/W	R/W	R/W
RTCRST	0	0	0	0	0	0	0	0
Other resets	Note	Note	Note	Note	Note	Note	Note	Note

Bit	D7	D6	D5	D4	D3	D2	D1	D0
Name	RTCL1P[7]	RTCL1P[6]	RTCL1P[5]	RTCL1P[4]	RTCL1P[3]	RTCL1P[2]	RTCL1P[1]	RTCL1P[0]
R/W	R/W	R/W	R/W	R/W	R/W	R/W	R/W	R/W
RTCRST	0	0	0	0	0	0	0	0
Other resets	Note	Note	Note	Note	Note	Note	Note	Note

Bit	Name	Function
D[15:0]	RTCL1P[15:0]	[15:0] for RTCLong1 counter cycle

Note Previous value is retained

(2) RTCL1HREG (0x0B00 00D2)

Bit	D15	D14	D13	D12	D11	D10	D9	D8
Name	Reserved	Reserved	Reserved	Reserved	Reserved	Reserved	Reserved	Reserved
R/W	R	R	R	R	R	R	R	R
RTCRST	0	0	0	0	0	0	0	0
Other resets	Note	Note	Note	Note	Note	Note	Note	Note

Bit	D7	D6	D5	D4	D3	D2	D1	D0
Name	RTCL1P[23]	RTCL1P[22]	RTCL1P[21]	RTCL1P[20]	RTCL1P[19]	RTCL1P[18]	RTCL1P[17]	RTCL1P[16]
R/W	R/W	R/W	R/W	R/W	R/W	R/W	R/W	R/W
RTCRST	0	0	0	0	0	0	0	0
Other resets	Note	Note	Note	Note	Note	Note	Note	Note

Bit	Name	Function
D[15:8]	Reserved	Write 0 when writing. 0 is returned after a read.
D[7:0]	RTCL1P[23:16]	[23:16] for RTCLong1 counter cycle

Note Previous value is retained

Use these registers to set the RTCLong1 counter cycle. The RTCLong1 counter begins its countdown at the value written to these registers.

A write operation is valid once values have been written to both registers (RTCL1LREG and RTCL1HREG).

Cautions 1. The RTC unit is stopped when all zeros are written.

2. Any combined setting of “RTCL1HREG = 0x0000” and “RTCL1LREG = 0x0001, 0x0002, 0x0003, 0x0004” is prohibited.

16.2.4 RTC Long 1 Count Registers

(1) RTCL1CNTLREG (0x0B00 00D4)

Bit	D15	D14	D13	D12	D11	D10	D9	D8
Name	RTCL1C[15]	RTCL1C[14]	RTCL1C[13]	RTCL1C[12]	RTCL1C[11]	RTCL1C[10]	RTCL1C[9]	RTCL1C[8]
R/W	R	R	R	R	R	R	R	R
RTCRST	0	0	0	0	0	0	0	0
Other resets	Note	Note	Note	Note	Note	Note	Note	Note

Bit	D7	D6	D5	D4	D3	D2	D1	D0
Name	RTCL1C[7]	RTCL1C[6]	RTCL1C[5]	RTCL1C[4]	RTCL1C[3]	RTCL1C[2]	RTCL1C[1]	RTCL1C[0]
R/W	R	R	R	R	R	R	R	R
RTCRST	0	0	0	0	0	0	0	0
Other resets	Note	Note	Note	Note	Note	Note	Note	Note

Bit	Name	Function
D[15:0]	RTCL1C[15:0]	RTCLong1 counter bit [15:0]

Note Continues counting

(2) RTCL1CNTHREG (0x0B00 00D6)

Bit	D15	D14	D13	D12	D11	D10	D9	D8
Name	Reserved	Reserved	Reserved	Reserved	Reserved	Reserved	Reserved	Reserved
R/W	R	R	R	R	R	R	R	R
RTCRST	0	0	0	0	0	0	0	0
Other resets	Note	Note	Note	Note	Note	Note	Note	Note

Bit	D7	D6	D5	D4	D3	D2	D1	D0
Name	RTCL1C[23]	RTCL1C[22]	RTCL1C[21]	RTCL1C[20]	RTCL1C[19]	RTCL1C[18]	RTCL1C[17]	RTCL1C[16]
R/W	R	R	R	R	R	R	R	R
RTCRST	0	0	0	0	0	0	0	0
Other resets	Note	Note	Note	Note	Note	Note	Note	Note

Bit	Name	Function
D[15:8]	Reserved	Write 0 when writing. 0 is returned after a read.
D[7:0]	RTCL1C[23:16]	RTCLong1 counter bit [23:16]

Note Continues counting

These registers indicate the RTCLong1 counter's values. The countdown uses a 32.768-kHz cycle and begins at the value set to the RTCLong1 registers. An RTCLong1 interrupt occurs when the counter reaches 0x00 0001 (at which point the counter returns to the start value and continues counting).

16.2.5 RTC Long 2 Registers

(1) RTCL2LREG (0x0B00 00D8)

Bit	D15	D14	D13	D12	D11	D10	D9	D8
Name	RTCL2P[15]	RTCL2P[14]	RTCL2P[13]	RTCL2P[12]	RTCL2P[11]	RTCL2P[10]	RTCL2P[9]	RTCL2P[8]
R/W	R/W	R/W	R/W	R/W	R/W	R/W	R/W	R/W
RTCRST	0	0	0	0	0	0	0	0
Other resets	Note	Note	Note	Note	Note	Note	Note	Note

Bit	D7	D6	D5	D4	D3	D2	D1	D0
Name	RTCL2P[7]	RTCL2P[6]	RTCL2P[5]	RTCL2P[4]	RTCL2P[3]	RTCL2P[2]	RTCL2P[1]	RTCL2P[0]
R/W	R/W	R/W	R/W	R/W	R/W	R/W	R/W	R/W
RTCRST	0	0	0	0	0	0	0	0
Other resets	Note	Note	Note	Note	Note	Note	Note	Note

Bit	Name	Function
D[15:0]	RTCL2P[15:0]	[15:0] for RTCLong2 counter cycle

Note Previous value is retained

(2) RTCL2HREG (0x0B00 00DA)

Bit	D15	D14	D13	D12	D11	D10	D9	D8
Name	Reserved	Reserved	Reserved	Reserved	Reserved	Reserved	Reserved	Reserved
R/W	R	R	R	R	R	R	R	R
RTCRST	0	0	0	0	0	0	0	0
Other resets	Note	Note	Note	Note	Note	Note	Note	Note

Bit	D7	D6	D5	D4	D3	D2	D1	D0
Name	RTCL2P[23]	RTCL2P[22]	RTCL2P[21]	RTCL2P[20]	RTCL2P[19]	RTCL2P[18]	RTCL2P[17]	RTCL2P[16]
R/W	R/W	R/W	R/W	R/W	R/W	R/W	R/W	R/W
RTCRST	0	0	0	0	0	0	0	0
Other resets	Note	Note	Note	Note	Note	Note	Note	Note

Bit	Name	Function
D[15:8]	Reserved	Write 0 when writing. 0 is returned after a read.
D[7:0]	RTCL2P[23:16]	[23:16] for RTCLong2 counter cycle

Note Previous value is retained

Use these registers to set the RTCLong2 counter cycle. The RTCLong2 counter begins its countdown at the value written to these registers.

A write operation is valid once values have been written to both registers (RTCL2LREG and RTCL2HREG).

Cautions 1. The RTC unit is stopped when all zeros are written.

2. Any combined setting of “RTCL2HREG = 0x0000” and “RTCL2LREG = 0x0001, 0x0002, 0x0003, 0x0004” is prohibited.

16.2.6 RTC Long 2 Count Registers

(1) RTCL2CNTLREG (0x0B00 00DC)

Bit	D15	D14	D13	D12	D11	D10	D9	D8
Name	RTCL2C[15]	RTCL2C[14]	RTCL2C[13]	RTCL2C[12]	RTCL2C[11]	RTCL2C[10]	RTCL2C[9]	RTCL2C[8]
R/W	R	R	R	R	R	R	R	R
RTCRST	0	0	0	0	0	0	0	0
Other resets	Note	Note	Note	Note	Note	Note	Note	Note

Bit	D7	D6	D5	D4	D3	D2	D1	D0
Name	RTCL2C[7]	RTCL2C[6]	RTCL2C[5]	RTCL2C[4]	RTCL2C[3]	RTCL2C[2]	RTCL2C[1]	RTCL2C[0]
R/W	R	R	R	R	R	R	R	R
RTCRST	0	0	0	0	0	0	0	0
Other resets	Note	Note	Note	Note	Note	Note	Note	Note

Bit	Name	Function
D[15:0]	RTCL2C[15:0]	RTCLong2 counter bit [15:0]

Note Continues counting

(2) RTCL2CNTHREG (0x0B00 00DE)

Bit	D15	D14	D13	D12	D11	D10	D9	D8
Name	Reserved	Reserved	Reserved	Reserved	Reserved	Reserved	Reserved	Reserved
R/W	R	R	R	R	R	R	R	R
RTCRST	0	0	0	0	0	0	0	0
Other resets	Note	Note	Note	Note	Note	Note	Note	Note

Bit	D7	D6	D5	D4	D3	D2	D1	D0
Name	RTCL2C[23]	RTCL2C[22]	RTCL2C[21]	RTCL2C[20]	RTCL2C[19]	RTCL2C[18]	RTCL2C[17]	RTCL2C[16]
R/W	R	R	R	R	R	R	R	R
RTCRST	0	0	0	0	0	0	0	0
Other resets	Note	Note	Note	Note	Note	Note	Note	Note

Bit	Name	Function
D[15:8]	Reserved	Write 0 when writing. 0 is returned after a read.
D[7:0]	RTCL2C[23:16]	RTCLong2 counter bit [23:16]

Note Continues counting

These registers indicate the RTCLong2 counter's values. The countdown uses a 32.768-kHz cycle and begins at the value set to the RTCLong2 registers. An RTCLong2 interrupt occurs when the counter reaches 0x00 0001 (at which point the counter returns to the start value and continues counting).

16.2.7 TClock Counter Registers

(1) TCLKREG (0x0B00 01C0)

Bit	D15	D14	D13	D12	D11	D10	D9	D8
Name	TCLKP[15]	TCLKP[14]	TCLKP[13]	TCLKP[12]	TCLKP[11]	TCLKP[10]	TCLKP[9]	TCLKP[8]
R/W	R/W	R/W	R/W	R/W	R/W	R/W	R/W	R/W
RTCST	0	0	0	0	0	0	0	0
Other resets	0	0	0	0	0	0	0	0

Bit	D7	D6	D5	D4	D3	D2	D1	D0
Name	TCLKP[7]	TCLKP[6]	TCLKP[5]	TCLKP[4]	TCLKP[3]	TCLKP[2]	TCLKP[1]	TCLKP[0]
R/W	R/W	R/W	R/W	R/W	R/W	R/W	R/W	R/W
RTCST	0	0	0	0	0	0	0	0
Other resets	0	0	0	0	0	0	0	0

Bit	Name	Function
D[15:0]	TCLKP[15:0]	[15:0] for TClock counter cycle

(2) TCLKHREG (0x0B00 01C2)

Bit	D15	D14	D13	D12	D11	D10	D9	D8
Name	Reserved	Reserved	Reserved	Reserved	Reserved	Reserved	Reserved	TCLKP[24]
R/W	R	R	R	R	R	R	R	R/W
RTCRST	0	0	0	0	0	0	0	0
Other resets	0	0	0	0	0	0	0	0

Bit	D7	D6	D5	D4	D3	D2	D1	D0
Name	TCLKP[23]	TCLKP[22]	TCLKP[21]	TCLKP[20]	TCLKP[19]	TCLKP[18]	TCLKP[17]	TCLKP[16]
R/W	R/W	R/W	R/W	R/W	R/W	R/W	R/W	R/W
RTCRST	0	0	0	0	0	0	0	0
Other resets	0	0	0	0	0	0	0	0

Bit	Name	Function
D[15:9]	Reserved	Write 0 when writing. 0 is returned after a read.
D[8:0]	TCLKP[24:16]	[24:16] for TClock counter cycle

Use these registers to set the TCLK counter cycle. The TCLK counter begins its countdown at the value written to these registers.

A write operation is valid once values have been written to both registers (TCLKLREG and TCLKHREG).

Caution The TCLK unit is stopped when all zeros are written.

16.2.8 TClock Counter Count Registers

(1) TCLKCNTLREG (0x0B00 01C4)

Bit	D15	D14	D13	D12	D11	D10	D9	D8
Name	TCLKC[15]	TCLKC[14]	TCLKC[13]	TCLKC[12]	TCLKC[11]	TCLKC[10]	TCLKC[9]	TCLKC[8]
R/W	R	R	R	R	R	R	R	R
RTCRST	0	0	0	0	0	0	0	0
Other resets	0	0	0	0	0	0	0	0

Bit	D7	D6	D5	D4	D3	D2	D1	D0
Name	TCLKC[7]	TCLKC[6]	TCLKC[5]	TCLKC[4]	TCLKC[3]	TCLKC[2]	TCLKC[1]	TCLKC[0]
R/W	R	R	R	R	R	R	R	R
RTCRST	0	0	0	0	0	0	0	0
Other resets	0	0	0	0	0	0	0	0

Bit	Name	Function
D[15:0]	TCLKC[15:0]	TClock counter [15:0]

(2) TCLKCNTHREG (0x0B00 01C6)

Bit	D15	D14	D13	D12	D11	D10	D9	D8
Name	Reserved	Reserved	Reserved	Reserved	Reserved	Reserved	Reserved	TCLKC[24]
R/W	R	R	R	R	R	R	R	R
RTCST	0	0	0	0	0	0	0	0
Other resets	0	0	0	0	0	0	0	0

Bit	D7	D6	D5	D4	D3	D2	D1	D0
Name	TCLKC[23]	TCLKC[22]	TCLKC[21]	TCLKC[20]	TCLKC[19]	TCLKC[18]	TCLKC[17]	TCLKC[16]
R/W	R	R	R	R	R	R	R	R
RTCST	0	0	0	0	0	0	0	0
Other resets	0	0	0	0	0	0	0	0

Bit	Name	Function
D[15:9]	Reserved	Write 0 when writing. 0 is returned after a read.
D[8:0]	TCLKC[24:16]	TClock counter [24:16]

Use these registers to set the TCLK counter value. The TCLKCNT counter begins its countdown at the value written to the TCLK counter registers. A TCLK counter interrupt occurs when the counter reaches 0x000 0001 (at which point the counter returns to the start value and continues counting).

16.2.9 RTC Interrupt Register

(1) RTCINTREG (0x0B00 01DE)

Bit	D15	D14	D13	D12	D11	D10	D9	D8
Name	Reserved	Reserved	Reserved	Reserved	Reserved	Reserved	Reserved	Reserved
R/W	R	R	R	R	R	R	R	R
RTCRST	0	0	0	0	0	0	0	0
Other resets	0	0	0	0	0	0	0	0

Bit	D7	D6	D5	D4	D3	D2	D1	D0
Name	Reserved	Reserved	Reserved	Reserved	RTCINTR3	RTCINTR2	RTCINTR1	RTCINTR0
R/W	R	R	R	R	R/W	R/W	R/W	R/W
RTCRST	0	0	0	0	0	0	0	0
Other resets	0	0	0	0	0	Note	Note	Note

Bit	Name	Function
D[15:4]	Reserved	Write 0 when writing. 0 is returned after a read.
D[3]	RTCINTR3	TClock counter interrupt. Cleared to 0 when 1 is written. 1 : Occurred 0 : Normal
D[2]	RTCINTR2	RTCLong2 interrupt. Cleared to 0 when 1 is written. 1 : Occurred 0 : Normal
D[1]	RTCINTR1	RTCLong1 interrupt. Cleared to 0 when 1 is written. 1 : Occurred 0 : Normal
D[0]	RTCINTR0	Status bit for elapsed time interrupt. Cleared to 0 when 1 is written. 1 : Occurred 0 : Normal

Note Previous value is retained

This register is used to monitor interrupts.

[MEMO]

CHAPTER 17 DSU (DEADMAN'S SWITCH UNIT)

This chapter describes the DSU (Deadman's Switch Unit)'s operations and register settings.

17.1 GENERAL

The DSU detects when the VR4102 is in runaway (endless loop) state and resets the VR4102 to minimize runaway time. The use of the DSU to minimize runaway time effectively minimizes data loss that can occur due to software-related runaway states.

17.2 REGISTER SET

The DSU registers are listed below.

Table 17-1. DSU Registers

Address	R/W	Symbol	Function
0x0B00 00E0	R/W	DSUCNTREG	DSU Control Register
0x0B00 00E2	R/W	DSUSETREG	DSU Dead Time Set Register
0x0B00 00E4	W	DSUCLRREG	DSU Clear Register
0x0B00 00E6	R/W	DSUTIMREG	DSU Elapsed Time Register

Each register is described in detail below.

17.2.1 DSUCNTREG (0x0B00 00E0)

Bit	D15	D14	D13	D12	D11	D10	D9	D8
Name	Reserved	Reserved	Reserved	Reserved	Reserved	Reserved	Reserved	Reserved
R/W	R	R	R	R	R	R	R	R
RTCRST	0	0	0	0	0	0	0	0
Other resets	0	0	0	0	0	0	0	0

Bit	D7	D6	D5	D4	D3	D2	D1	D0
Name	Reserved	Reserved	Reserved	Reserved	Reserved	Reserved	Reserved	DSWEN
R/W	R	R	R	R	R	R	R	R/W
RTCRST	0	0	0	0	0	0	0	0
Other resets	0	0	0	0	0	0	0	0

Bit	Name	Function
D[15..1]	Reserved	Write 0 when writing. 0 is returned after a read.
D[0]	DSWEN	Deadman's Switch function enable 1 : Enable 0 : Prohibit

This register is used to enable use of the Deadman's Switch functions.

17.2.2 DSUSETREG (0x0B00 00E2)

Bit	D15	D14	D13	D12	D11	D10	D9	D8
Name	Reserved	Reserved	Reserved	Reserved	Reserved	Reserved	Reserved	Reserved
R/W	R	R	R	R	R	R	R	R
RTCRST	0	0	0	0	0	0	0	0
Other resets	0	0	0	0	0	0	0	0

Bit	D7	D6	D5	D4	D3	D2	D1	D0
Name	Reserved	Reserved	Reserved	Reserved	DEDTIME[3]	DEDTIME[2]	DEDTIME[1]	DEDTIME[0]
R/W	R	R	R	R	R/W	R/W	R/W	R/W
RTCRST	0	0	0	0	0	0	0	0
Other resets	0	0	0	0	0	0	0	0

Bit	Name	Function
D[15..4]	Reserved	Write 0 when writing. 0 is returned after a read.
D[3..0]	DEDTIME[3..0]	Deadman's Switch cycle setting 1111 15 sec 1110 14 sec : 0010 2 sec 0001 1 sec 0000 RFU

This register sets the cycle for Deadman's Switch functions.

The Deadman's Switch cycle can be set in 1-second increments in a range from 1 to 15 seconds. However, the VR4102's operation is undefined when 0x0 has been set to DEDTIME[3..0]. The DSUCLRREG's DSWCLR bit must be set by software within the specified cycle time.

17.2.3 DSUCLRREG (0x0B00 00E4)

Bit	D15	D14	D13	D12	D11	D10	D9	D8
Name	Reserved	Reserved	Reserved	Reserved	Reserved	Reserved	Reserved	Reserved
R/W	R	R	R	R	R	R	R	R
RTCRST	0	0	0	0	0	0	0	0
Other resets	0	0	0	0	0	0	0	0

Bit	D7	D6	D5	D4	D3	D2	D1	D0
Name	Reserved	Reserved	Reserved	Reserved	Reserved	Reserved	Reserved	DSWCLR
R/W	R	R	R	R	R	R	R	W
RTCRST	0	0	0	0	0	0	0	0
Other resets	0	0	0	0	0	0	0	0

Bit	Name	Function
D[15..1]	Reserved	Write 0 when writing. 0 is returned after a read.
D[0]	DSWCLR	Deadman's Switch counter clear. Cleared to 0 when 1 is written. 1 : Clear 0 : Don't clear

This register clears the Deadman's Switch counter.

The VR4102 automatically shuts down if 1 is not written to this register within the period set in DSUSETREG.

17.2.4 DSUTIMREG (0x0B00 00E6)

Bit	D15	D14	D13	D12	D11	D10	D9	D8
Name	Reserved	Reserved	Reserved	Reserved	Reserved	Reserved	Reserved	Reserved
R/W	R	R	R	R	R	R	R	R
RTCRST	0	0	0	0	0	0	0	0
Other resets	0	0	0	0	0	0	0	0

Bit	D7	D6	D5	D4	D3	D2	D1	D0
Name	Reserved	Reserved	Reserved	Reserved	CRTTIME[3]	CRTTIME[2]	CRTTIME[1]	CRTTIME[0]
R/W	R	R	R	R	R/W	R/W	R/W	R/W
RTCRST	0	0	0	0	0	0	0	0
Other resets	0	0	0	0	0	0	0	0

Bit	Name	Function
D[15..4]	Reserved	Write 0 when writing. 0 is returned after a read.
D[3..0]	CRTTIME[3..0]	Current Deadman's Switch timer value (elapsed time) 1111 15 sec 1110 14 sec : 0010 2 sec 0001 1 sec 0000 RFU

This register indicates the elapsed time for the current Deadman's Switch timer.

17.3 REGISTER SETTING FLOW

The DSU register setting flow is described below.

1. Set the DSU's count-up value (From 1 to 15 seconds).

The CPU will be reset if it does not clear (1 is not written to DSUCLRREG) the timer within this time period.

DSUDTMREG address : 0x0B00 00E2 data : 0x000x

2. Enable the DSU.

DSUCNTREG address : 0x0B00 00E0 data : 0x0001

3. Clear the timer within the time period mentioned in step 1 above.

DSUCLRREG address : 0x0B00 00E4 data : 0x0001

For normal use, repeat step 3. To obtain the current elapsed time:

DSITIMREG address : 0x0B00 00E6 read (4 bits)

4. Disable the DSU for Suspend mode or a shutdown.

DSUCNTREG address : 0x0B00 00E0 data : 0x0000

CHAPTER 18 GIU (GENERAL PURPOSE I/O UNIT)

This chapter describes the GIU's operations and register settings.

18.1 GENERAL

The GIU controls GPIO and DCD# pins. GPIO pins are ports that support output functions and input functions (including three types of interrupt trigger detection functions). The interrupts occur in response to an input signal change (rising edge or falling edge of signal), low level, or high level.

The clocks and input buffer types used for interrupt detection at a GPIO pin are listed below.

When not used for an interrupt, the registers corresponding to these pins can be written to output a low-level or high-level signal.

Each register can be read to check the state of the signal currently being input to the corresponding pin.

Table 18-1. GPIO Pin Functions

Pin	Interrupt detection clock (internal)	Input buffer type	Output clock (internal)
GPIO[49..32]	–	–	TClock
GPIO[31..16]	TClock	Normal	TClock
GPIO[15](DCD#)	MasterOut	Normal	–
GPIO[14..9]	MasterOut	Normal	MasterOut
GPIO[8..5]	TClock	Normal	MasterOut
GPIO[4]	TClock	Schmitt	TClock
GPIO[3..0]	RTC	Schmitt	RTC

Cautions The function of GPIO[15] is fixed as DCD# input signal. This pin cannot be used as a general-purpose input/output pin.

18.2 REGISTER SET

The GIU registers are listed below.

Table 18-2. GIU Registers

Address	R/W	Register Symbols	Function
0x0B00 0100	R/W	GIUIOSELL	GPIO Input/Output Select Register L
0x0B00 0102	R/W	GIUIOSELH	GPIO Input/Output Select Register H
0x0B00 0104	R/W	GIUIODL	GPIO Port Input/Output Data Register L
0x0B00 0106	R/W	GIUIODH	GPIO Port Input/Output Data Register H
0x0B00 0108	R/W	GIUINTSTATL	GPIO Interrupt Status Register L
0x0B00 010A	R/W	GIUINTSTATH	GPIO Interrupt Status Register H
0x0B00 010C	R/W	GIUINTENL	GPIO Interrupt Enable Register L
0x0B00 010E	R/W	GIUINTENH	GPIO Interrupt Enable Register H
0x0B00 0110	R/W	GIUINTTYPL	GPIO Interrupt Type (Edge or Level) Select Register L
0x0B00 0112	R/W	GIUINTTYPH	GPIO Interrupt Type (Edge or Level) Select Register H
0x0B00 0114	R/W	GIUINTALSELL	GPIO Interrupt Active Level Select Register L
0x0B00 0116	R/W	GIUINTALSELH	GPIO Interrupt Active Level Select Register H
0x0B00 0118	R/W	GIUINTHTSELL	GPIO Interrupt Hold/Through Select Register L
0x0B00 011A	R/W	GIUINTHTSELH	GPIO Interrupt Hold/Through Select Register H
0x0B00 011C	R/W	GIUPODATL	GPIO Port Output Data Register L
0x0B00 011E	R/W	GIUPODATH	GPIO Port Output Data Register H

18.2.1 GIUIOSELL (0x0B00 0100)

Bit	D15	D14	D13	D12	D11	D10	D9	D8
Name	IOS[15]	IOS[14]	IOS[13]	IOS[12]	IOS[11]	IOS[10]	IOS[9]	IOS[8]
R/W	R	R/W	R/W	R/W	R/W	R/W	R/W	R/W
RTCRST	0	0	0	0	0	0	0	0
Other resets	0	0	0	0	0	0	0	0

Bit	D7	D6	D5	D4	D3	D2	D1	D0
Name	IOS[7]	IOS[6]	IOS[5]	IOS[4]	IOS[3]	IOS[2]	IOS[1]	IOS[0]
R/W	R/W	R/W	R/W	R/W	R/W	R/W	R/W	R/W
RTCRST	0	0	0	0	0	0	0	0
Other resets	0	0	0	0	0	0	0	0

Bit	Name	Function
D[15..0]	IOS[15..0]	GPIO pin input/output select 1 : Output 0 : Input

This register is used to set input/output values for GPIO[15..0] pins.

When the IOS bit is set to “1”, the corresponding GPIO pin is set for output and the value that has been written to the corresponding PIOD bit in the GIUPIODL (GPIO Port Input/Output Data Register) is output.

When this bit is set to “0”, the corresponding GPIO pin is set for input.

Caution Since IOS[15] (GPIO[15] (DCD#)) is fixed as input, it cannot be set for output.

18.2.2 GIUIOSELH (0x0B00 0102)

Bit	D15	D14	D13	D12	D11	D10	D9	D8
Name	IOS[31]	IOS[30]	IOS[29]	IOS[28]	IOS[27]	IOS[26]	IOS[25]	IOS[24]
R/W	R/W	R/W	R/W	R/W	R/W	R/W	R/W	R/W
RTCRST	0	0	0	0	0	0	0	0
Other resets	0	0	0	0	0	0	0	0

Bit	D7	D6	D5	D4	D3	D2	D1	D0
Name	IOS[23]	IOS[22]	IOS[21]	IOS[20]	IOS[19]	IOS[18]	IOS[17]	IOS[16]
R/W	R/W	R/W	R/W	R/W	R/W	R/W	R/W	R/W
RTCRST	0	0	0	0	0	0	0	0
Other resets	0	0	0	0	0	0	0	0

Bit	Name	Function
D[15..0]	IOS[31..16]	GPIO pin input/output select 1 : Output 0 : Input

This register is used to set input/output settings for GPIO[31..16] pins.

When the IOS bit is set to “1”, the corresponding GPIO pin is set for output and the value that has been written to the corresponding PIOD bit in the GIUPIODH (GPIO Port Input/Output Data Register) is output.

When this bit is set to “0”, the corresponding GPIO pin is set for input.

18.2.3 GIUPIODL (0x0B00 0104)

Bit	D15	D14	D13	D12	D11	D10	D9	D8
Name	PIOD[15]	PIOD[14]	PIOD[13]	PIOD[12]	PIOD[11]	PIOD[10]	PIOD[9]	PIOD[8]
R/W	R	R/W	R/W	R/W	R/W	R/W	R/W	R/W
RTCRST	0	0	0	0	0	0	0	0
Other resets	0	0	0	0	0	0	0	0

Bit	D7	D6	D5	D4	D3	D2	D1	D0
Name	PIOD[7]	PIOD[6]	PIOD[5]	PIOD[4]	PIOD[3]	PIOD[2]	PIOD[1]	PIOD[0]
R/W	R/W	R/W	R/W	R/W	R/W	R/W	R/W	R/W
RTCRST	0	0	0	0	0	0	0	0
Other resets	0	0	0	0	0	0	0	0

Bit	Name	Function
D[15..0]	PIOD[15..0]	GPIO pin output data specification 1 : High 0 : Low

This register is used to read GPIO pins and write data. The PIOD[15..0] bits correspond to the GPIO[15..0] pins.

When “1” is set to the corresponding IOS bit in the GIUIOSELL register (GPIO Input/Output Select Register), the data written to the PIOD bit is output via the corresponding GPIO pin.

When the value of the corresponding IOS bit in the GIUIOSELL register (GPIO Input/Output Select Register) is “0”, writing a value to the PIOD bit does not affect the GPIO pin (the write data is ignored).

When the value of the IOS bit in the GIUIOSELL register (GPIO Input/Output Select Register) is “0”, reading the PIOD bit enables the corresponding GPIO pin’s state to be read.

Caution Since PIOD[15] (GPIO[15] (DCD#)) is fixed as input, write data cannot be output via this pin.

18.2.4 GIUPIODH (0x0B00 0106)

Bit	D15	D14	D13	D12	D11	D10	D9	D8
Name	PIOD[31]	PIOD[30]	PIOD[29]	PIOD[28]	PIOD[27]	PIOD[26]	PIOD[25]	PIOD[24]
R/W	R/W	R/W	R/W	R/W	R/W	R/W	R/W	R/W
RTCRST	0	0	0	0	0	0	0	0
Other resets	0	0	0	0	0	0	0	0

Bit	D7	D6	D5	D4	D3	D2	D1	D0
Name	PIOD[23]	PIOD[22]	PIOD[21]	PIOD[20]	PIOD[19]	PIOD[18]	PIOD[17]	PIOD[16]
R/W	R/W	R/W	R/W	R/W	R/W	R/W	R/W	R/W
RTCRST	0	0	0	0	0	0	0	0
Other resets	0	0	0	0	0	0	0	0

Bit	Name	Function
D[15..0]	PIOD[31..16]	GPIO pin output data specification 1 : High 0 : Low

This register is used to read GPIO pins and write data. The PIOD[31..16] bits correspond to the GPIO[31..16] pins.

When “1” is set to the corresponding IOS bit in the GIUIOSELH register (GPIO Input/Output Select Register), the data written to the PIOD bit is output via the corresponding GPIO pin.

When the value of the corresponding IOS bit in the GIUIOSELH register (GPIO Input/Output Select Register) is “0”, writing a value to the PIOD bit does not affect the GPIO pin (the write data is ignored).

When the value of the IOS bit in the GIUIOSELH register (GPIO Input/Output Select Register) is “0”, reading the PIOD bit enables the corresponding GPIO pin’s state to be read.

18.2.5 GIUINTSTATL (0x0B00 0108)

Bit	D15	D14	D13	D12	D11	D10	D9	D8
Name	INTS[15]	INTS[14]	INTS[13]	INTS[12]	INTS[11]	INTS[10]	INTS[9]	INTS[8]
R/W	R/W	R/W	R/W	R/W	R/W	R/W	R/W	R/W
RTCRST	0	0	0	0	0	0	0	0
Other resets	0	0	0	0	0	0	0	0

Bit	D7	D6	D5	D4	D3	D2	D1	D0
Name	INTS[7]	INTS[6]	INTS[5]	INTS[4]	INTS[3]	INTS[2]	INTS[1]	INTS[0]
R/W	R/W	R/W	R/W	R/W	R/W	R/W	R/W	R/W
RTCRST	0	0	0	0	0	0	0	0
Other resets	0	0	0	0	0	0	0	0

Bit	Name	Function
D[15..0]	INTS[15..0]	Interrupt to GPIO pin. Cleared to 0 when 1 is written. 1 : Interrupt occurred 0 : No interrupt

This register indicates the interrupt status of GPIO pins. The INTS[15..0] bits correspond to the GPIO[15..0] pins.

“1” is set to the corresponding INTS bit when “1” is set to the corresponding INTE bit in the GIUINTENL register (GPIO Interrupt Enable Register) and when the signal input to an interrupt-enabled GPIO pin meets the conditions set via the GIUNTTYPL register (GPIO Interrupt Type (Edge or Level) Select Register) and the GIUINTALSELL register (GPIO Interrupt Active Level Select Register).

Caution The function of GPIO[15] is fixed as DCD# signal input.

18.2.6 GIUINTSTATH (0x0B00 010A)

Bit	D15	D14	D13	D12	D11	D10	D9	D8
Name	INTS[31]	INTS[30]	INTS[29]	INTS[28]	INTS[27]	INTS[26]	INTS[25]	INTS[24]
R/W	R/W	R/W	R/W	R/W	R/W	R/W	R/W	R/W
RTCRST	0	0	0	0	0	0	0	0
Other resets	0	0	0	0	0	0	0	0

Bit	D7	D6	D5	D4	D3	D2	D1	D0
Name	INTS[23]	INTS[22]	INTS[21]	INTS[20]	INTS[19]	INTS[18]	INTS[17]	INTS[16]
R/W	R/W	R/W	R/W	R/W	R/W	R/W	R/W	R/W
RTCRST	0	0	0	0	0	0	0	0
Other resets	0	0	0	0	0	0	0	0

Bit	Name	Function
D[15..0]	INTS[31..16]	Interrupt to GPIO pin. Cleared to 0 when 1 is written. 1 : Interrupt occurred 0 : No interrupt

This register indicates the interrupt status of GPIO pins. The INTS[31..16] bits correspond to the GPIO[31..16] pins.

“1” is set to the corresponding INTS bit when “1” is set to the corresponding INTE bit in the GIUINTENH register (GPIO Interrupt Enable Register) and when the signal input to an interrupt-enabled GPIO pin meets the conditions set via the GIUINTTYPH register (GPIO Interrupt Type (Edge or Level) Select Register) and the GIUINTALSELH register (GPIO Interrupt Active Level Select Register).

18.2.7 GIUINTENL (0x0B00 010C)

Bit	D15	D14	D13	D12	D11	D10	D9	D8
Name	INTE[15]	INTE[14]	INTE[13]	INTE[12]	INTE[11]	INTE[10]	INTE[9]	INTE[8]
R/W	R/W	R/W	R/W	R/W	R/W	R/W	R/W	R/W
RTCRST	0	0	0	0	0	0	0	0
Other resets	0	0	0	0	0	0	0	0

Bit	D7	D6	D5	D4	D3	D2	D1	D0
Name	INTE[7]	INTE[6]	INTE[5]	INTE[4]	INTE[3]	INTE[2]	INTE[1]	INTE[0]
R/W	R/W	R/W	R/W	R/W	R/W	R/W	R/W	R/W
RTCRST	0	0	0	0	0	0	0	0
Other resets	0	0	0	0	0	0	0	0

Bit	Name	Function
D[15..0]	INTE[15..0]	Interrupt enable to GPIO pin 1 : Interrupt enable 0 : Interrupt prohibit

This register is used to set interrupt enable status for GPIO pins. The INTE[15..0] bits correspond to the GPIO[15..0] pins.

When “1” is set to the corresponding INTE bit, interrupts are enabled for the corresponding GPIO pins.

Caution The function of GPIO[15] is fixed as DCD# signal input.

18.2.8 GIUINTENH (0x0B00 010E)

Bit	D15	D14	D13	D12	D11	D10	D9	D8
Name	INTE[31]	INTE[30]	INTE[29]	INTE[28]	INTE[27]	INTE[26]	INTE[25]	INTE[24]
R/W	R/W	R/W	R/W	R/W	R/W	R/W	R/W	R/W
RTCRST	0	0	0	0	0	0	0	0
Other resets	0	0	0	0	0	0	0	0

Bit	D7	D6	D5	D4	D3	D2	D1	D0
Name	INTE[23]	INTE[22]	INTE[21]	INTE[20]	INTE[19]	INTE[18]	INTE[17]	INTE[16]
R/W	R/W	R/W	R/W	R/W	R/W	R/W	R/W	R/W
RTCRST	0	0	0	0	0	0	0	0
Other resets	0	0	0	0	0	0	0	0

Bit	Name	Function
D[15..0]	INTE[31..16]	Interrupt enable to GPIO pin 1 : Interrupt enable 0 : Interrupt prohibit

This register is used to set interrupt enable status for GPIO pins. The INTE[31..16] bits correspond to the GPIO[31..16] pins.

When “1” is set to the corresponding INTE bit, interrupts are enabled for the corresponding GPIO pins.

18.2.9 GIUINTTYPL (0x0B00 0110)

Bit	D15	D14	D13	D12	D11	D10	D9	D8
Name	INTT[15]	INTT[14]	INTT[13]	INTT[12]	INTT[11]	INTT[10]	INTT[9]	INTT[8]
R/W	R/W	R/W	R/W	R/W	R/W	R/W	R/W	R/W
RTCRST	0	0	0	0	0	0	0	0
Other resets	0	0	0	0	0	0	0	0

Bit	D7	D6	D5	D4	D3	D2	D1	D0
Name	INTT[7]	INTT[6]	INTT[5]	INTT[4]	INTT[3]	INTT[2]	INTT[1]	INTT[0]
R/W	R/W	R/W	R/W	R/W	R/W	R/W	R/W	R/W
RTCRST	0	0	0	0	0	0	0	0
Other resets	0	0	0	0	0	0	0	0

Bit	Name	Function
D[15..0]	INTT[15..0]	Interrupt detection method 1 : Edge 0 : Level

This register is used to set the detection method (trigger) for interrupts to GPIO pins. The INTT[15..0] bits correspond to the GPIO[15..0] pins.

When “1” is set to the corresponding INTT bit, the edge detection method is used for the interrupt signal at the corresponding GPIO pin (an interrupt is triggered when the signal state changes from low to high or from high to low).

The level detection method is used when “0” is set, in which case the level set to corresponding bit in the GIUINTALSELL register (GPIO Interrupt Active Level Select Register) is detected.

Caution The function of GPIO[15] is fixed as DCD# signal input.

18.2.10 GIUINTTYPH (0x0B00 0112)

Bit	D15	D14	D13	D12	D11	D10	D9	D8
Name	INTT[31]	INTT[30]	INTT[29]	INTT[28]	INTT[27]	INTT[26]	INTT[25]	INTT[24]
R/W	R/W	R/W	R/W	R/W	R/W	R/W	R/W	R/W
RTCRST	0	0	0	0	0	0	0	0
Other resets	0	0	0	0	0	0	0	0

Bit	D7	D6	D5	D4	D3	D2	D1	D0
Name	INTT[23]	INTT[22]	INTT[21]	INTT[20]	INTT[19]	INTT[18]	INTT[17]	INTT[16]
R/W	R/W	R/W	R/W	R/W	R/W	R/W	R/W	R/W
RTCRST	0	0	0	0	0	0	0	0
Other resets	0	0	0	0	0	0	0	0

Bit	Name	Function
D[15..0]	INTT[31..16]	Interrupt detection method 1 : Edge 0 : Level

This register is used to set the detection method for interrupts to GPIO pins. The INTT[31..16] bits correspond to the GPIO[31..16] pins.

When “1” is set to the corresponding INTT bit, the edge detection method is used for the interrupt signal at the corresponding GPIO pin (an interrupt is triggered when the signal state changes from low to high or from high to low).

The level detection method is used when “0” is set, in which case the level set to corresponding bit in the GIUINTALSELH register (GPIO Interrupt Active Level Select Register) is detected.

18.2.11 GIUINTALSELL (0x0B00 0114)

Bit	D15	D14	D13	D12	D11	D10	D9	D8
Name	INTL[15]	INTL[14]	INTL[13]	INTL[12]	INTL[11]	INTL[10]	INTL[9]	INTL[8]
R/W	R/W	R/W	R/W	R/W	R/W	R/W	R/W	R/W
RTCRST	0	0	0	0	0	0	0	0
Other resets	0	0	0	0	0	0	0	0

Bit	D7	D6	D5	D4	D3	D2	D1	D0
Name	INTL[7]	INTL[6]	INTL[5]	INTL[4]	INTL[3]	INTL[2]	INTL[1]	INTL[0]
R/W	R/W	R/W	R/W	R/W	R/W	R/W	R/W	R/W
RTCRST	0	0	0	0	0	0	0	0
Other resets	0	0	0	0	0	0	0	0

Bit	Name	Function
D[15..0]	INTL[15..0]	Interrupt setting during level detection method 1 : High active 0 : Low active

This register is used to set the active level when using the level detection method for interrupts to GPIO pins. The INTL[15..0] bits correspond to the GPIO[15..0] pins.

When “1” is set to the corresponding INTL bit, the high-active level detection method is used for interrupts at the corresponding GPIO pin. The low-active level detection method is used when “0” is set to this bit.

The contents of this register are not reflected when the edge detection method is selected via the GIUINTTYPL register (GPIO Interrupt Type (Edge or Level) Select Register). When using this register, be sure to set the level detection method via the GIUINTTYPL register (GPIO Interrupt Type (Edge or Level) Select Register).

Caution The function of GPIO[15] is fixed as DCD# signal input.

18.2.12 GIUINTALSELH (0x0B00 0116)

Bit	D15	D14	D13	D12	D11	D10	D9	D8
Name	INTL[31]	INTL[30]	INTL[29]	INTL[28]	INTL[27]	INTL[26]	INTL[25]	INTL[24]
R/W	R/W	R/W	R/W	R/W	R/W	R/W	R/W	R/W
RTCRST	0	0	0	0	0	0	0	0
Other resets	0	0	0	0	0	0	0	0

Bit	D7	D6	D5	D4	D3	D2	D1	D0
Name	INTL[23]	INTL[22]	INTL[21]	INTL[20]	INTL[19]	INTL[18]	INTL[17]	INTL[16]
R/W	R/W	R/W	R/W	R/W	R/W	R/W	R/W	R/W
RTCRST	0	0	0	0	0	0	0	0
Other resets	0	0	0	0	0	0	0	0

Bit	Name	Function
D[15..0]	INTL[31..16]	Interrupt setting during level detection method 1 : High active 0 : Low active

This register is used to set the active level when using the level detection method for interrupts to GPIO pins. The INTL[31..16] bits correspond to the GPIO[31..16] pins.

When “1” is set to the corresponding INTL bit, the high-active level detection method is used for interrupts at the corresponding GPIO pin. The low-active level detection method is used when “0” is set to this bit.

The contents of this register are not reflected when the edge detection method is selected via the GIUINTTYPH register (GPIO Interrupt Type (Edge or Level) Select Register). When using this register, be sure to set the level detection method via the GIUINTTYPH register (GPIO Interrupt Type (Edge or Level) Select Register).

18.2.13 GIUINTHTSELL (0x0B00 0118)

Bit	D15	D14	D13	D12	D11	D10	D9	D8
Name	INTH[15]	INTH[14]	INTH[13]	INTH[12]	INTH[11]	INTH[10]	INTH[9]	INTH[8]
R/W	R/W	R/W	R/W	R/W	R/W	R/W	R/W	R/W
RTCRST	0	0	0	0	0	0	0	0
Other resets	0	0	0	0	0	0	0	0

Bit	D7	D6	D5	D4	D3	D2	D1	D0
Name	INTH[7]	INTH[6]	INTH[5]	INTH[4]	INTH[3]	INTH[2]	INTH[1]	INTH[0]
R/W	R/W	R/W	R/W	R/W	R/W	R/W	R/W	R/W
RTCRST	0	0	0	0	0	0	0	0
Other resets	0	0	0	0	0	0	0	0

Bit	Name	Function
D[15..0]	INTH[15..0]	GPIO pin interrupt signal hold/through 1 : Hold 0 : Through

This register is used to set whether or not interrupt signals to the GPIO pins should be held. The INTH[15..0] bits correspond to the GPIO[15..0] pins.

When “1” is set to the corresponding INTH bit, any interrupt signal input to the corresponding GPIO pin is held.

When “0” is set to this bit, any interrupt signal input to the corresponding GPIO pin is not held and is instead allowed to pass through.

Any held interrupt signal is cleared when “1” is set to the corresponding bit in the GIUINTSTATL register (GPIO Interrupt Status Register).

INTH[15..0] are not affected by GIUINTENL (interrupt enable register).

If “1” (hold) is set to the INTH bit while the interrupt enable bit is set to prohibit interrupts, any change in the pin state is retained as change data. Therefore, an interrupt still occurs when the interrupt enable bit is again set to enable interrupts.

Caution The function of GPIO[15] is fixed as DCD# signal input.

18.2.14 GIUINTHTSELH (0x0B00 011A)

Bit	D15	D14	D13	D12	D11	D10	D9	D8
Name	INTH[31]	INTH[30]	INTH[29]	INTH[28]	INTH[27]	INTH[26]	INTH[25]	INTH[24]
R/W	R/W	R/W	R/W	R/W	R/W	R/W	R/W	R/W
RTCRST	0	0	0	0	0	0	0	0
Other resets	0	0	0	0	0	0	0	0

Bit	D7	D6	D5	D4	D3	D2	D1	D0
Name	INTH[23]	INTH[22]	INTH[21]	INTH[20]	INTH[19]	INTH[18]	INTH[17]	INTH[16]
R/W	R/W	R/W	R/W	R/W	R/W	R/W	R/W	R/W
RTCRST	0	0	0	0	0	0	0	0
Other resets	0	0	0	0	0	0	0	0

Bit	Name	Function
D[15..0]	INTH[31..16]	GPIO pin interrupt signal hold/through 1 : Hold 0 : Through

This register is used to set whether or not interrupt signals to the GPIO pins should be held. The INTH[31..16] bits correspond to the GPIO[31..16] pins.

When “1” is set to the corresponding INTH bit, any interrupt signal input to the corresponding GPIO pin is held.

When “0” is set to this bit, any interrupt signal input to the corresponding GPIO pin is not held and is instead allowed to pass through.

Any held interrupt signal is cleared when “1” is set to the corresponding bit in the GIUINTSTATH register (GPIO Interrupt Status Register).

INTH[31..16] are not affected by GIUINTENH (interrupt enable register).

If “1” (hold) is set to the INTH bit while the interrupt enable bit is set to prohibit interrupts, any change in the pin state is retained as change data. Therefore, an interrupt still occurs when the interrupt enable bit is again set to enable interrupts.

The relationship between settings of GPIO interrupts enable/prohibit and hold/through is as below.

Interrupt trigger	Setting of GIUINTHSEL	Setting of GIUINTEN	Hold in GIU	Notation to ICU
Level	Hold	Masked	Held	Not noticed
		Not masked	Held	Noticed
		Masked → canceled	Held	Noticed
	Through	Masked	Through	Not noticed
		Not masked	Through	Noticed
		Masked → canceled	Through	Not noticed
Edge	Hold	Masked	Held	Not noticed
		Not masked	Held	Noticed
		Masked → canceled	Held	Noticed
	Through	Masked	Through	Not noticed
		Not masked	Prohibited	Prohibited
		Masked → canceled	Through	Not noticed

18.2.15 GIUPODATL (0x0B00 011C)

Bit	D15	D14	D13	D12	D11	D10	D9	D8
Name	PIOD[47]	PIOD[46]	PIOD[45]	PIOD[44]	PIOD[43]	PIOD[42]	PIOD[41]	PIOD[40]
R/W	R/W	R/W	R/W	R/W	R/W	R/W	R/W	R/W
RTCRST	1	1	1	1	1	1	1	1
Other resets	1	1	1	1	1	1	1	1

Bit	D7	D6	D5	D4	D3	D2	D1	D0
Name	PIOD[39]	PIOD[38]	PIOD[37]	PIOD[36]	PIOD[35]	PIOD[34]	PIOD[33]	PIOD[32]
R/W	R/W	R/W	R/W	R/W	R/W	R/W	R/W	R/W
RTCRST	1	1	1	1	1	1	1	1
Other resets	1	1	1	1	1	1	1	1

Bit	Name	Function
D[15..0]	PIOD[47..32]	GPIO pin output data specification 1 : High 0 : Low

This register is used to set the output level for GPIO pins. The PIOD[47..32] bits correspond to the GPIO[47..32] pins.

The data written to the PIOD bit is output via the corresponding GPIO pin. The set value can be read by reading the PIOD bit.

Pins set by this register are output-only. Pins set by this register are used exclusively from other function pins. Therefore, when using this register, set the enable bit to prohibit in the corresponding unit.

The correspondences between PIOD bits and function pins are listed in the table on the next page.

Table 18-3. Table of Correspondences between GPIO[47..32] and Function Pins

PIOD Bit	GPIO pin	Function pin
PIOD[47]	GPIO[47]	DCTS#
PIOD[46]	GPIO[46]	DRTS#
PIOD[45]	GPIO[45]	DDIN
PIOD[44]	GPIO[44]	DDOUT
PIOD[43]	GPIO[43]	KSCAN[11]
PIOD[42]	GPIO[42]	KSCAN[10]
PIOD[41]	GPIO[41]	KSCAN[9]
PIOD[40]	GPIO[40]	KSCAN[8]
PIOD[39]	GPIO[39]	KSCAN[7]
PIOD[38]	GPIO[38]	KSCAN[6]
PIOD[37]	GPIO[37]	KSCAN[5]
PIOD[36]	GPIO[36]	KSCAN[4]
PIOD[35]	GPIO[35]	KSCAN[3]
PIOD[34]	GPIO[34]	KSCAN[2]
PIOD[33]	GPIO[33]	KSCAN[1]
PIOD[32]	GPIO[32]	KSCAN[0]

18.2.16 GIUPODATH (0x0B00 011E)

Bit	D15	D14	D13	D12	D11	D10	D9	D8
Name	Reserved	Reserved	Reserved	Reserved	Reserved	Reserved	PIOEN[1]	PIOEN[0]
R/W	R	R	R	R	R	R	R/W	R/W
RTCRST	0	0	0	0	0	0	0	0
Other resets	0	0	0	0	0	0	0	0

Bit	D7	D6	D5	D4	D3	D2	D1	D0
Name	Reserved	Reserved	Reserved	Reserved	Reserved	Reserved	PIOD[49]	PIOD[48]
R/W	R	R	R	R	R	R	R/W	R/W
RTCRST	0	0	0	0	0	0	0	0
Other resets	0	0	0	0	0	0	0	0

Bit	Name	Function
D[15..0]	Reserved	Reserved
D[9]	PIOEN[1]	GPIO[49] pin output control 1 : Enable 0 : Disable
D[8]	PIOEN[0]	GPIO[48]/DBUS32 pin output control 1 : Enable 0 : Disable
D[7..2]	Reserved	Reserved
D[1..0]	PIOD[49..48]	GPIO pin output data specification 1 : High 0 : Low

This register is used to set the output level for GPIO pins. The PIOEN[1..0] bits or the PIOD[49..48] bits correspond to the GPIO[49..48].

The data written to the PIOD bit is output via the corresponding GPIO pin. The set value can be read by reading the PIOD bit.

Pins set by this register are output-only. Pins set by this register are used exclusively from other function pins. Therefore, when using this register, set the enable bit to prohibit in the corresponding unit.

The correspondence between PIOD bit and function pin is listed below.

Table 18-4. Table of Correspondence between GPIO[48] and Function Pin

PIOD Bit	GPIO pin	Function pin
PIOD[48]	GPIO[48]	DBUS32

CHAPTER 19 PIU (TOUCH PANEL INTERFACE UNIT)

This chapter describes the PIU's operations and register settings.

19.1 GENERAL

The PIU uses an on-chip A/D converter and detects the X and Y coordinates of pen contact locations on the touch panel and scans the general-purpose A/D input port. Since the touch panel control circuit and the A/D converter (conversion precision: 10 bits) are both on-chip, the touch panel is connected directly to the VR4102.

The PIU's function, namely the detection of X and Y coordinates, is performed partly by hardware and partly by software.

Hardware tasks :

- Touch panel applied voltage control
- Reception of coordinate data

Software task : • Processing of coordinate data based on data sampled by hardware

Features of the PIU's hardware tasks are described below.

- Can be directly connected to touch panel with four-pin resistance layers (on-chip touch panel driver)
- Interface for on-chip A/D converter
- Voltage detection at three general-purpose AD ports and one audio input port
- Operation of A/D converter based on various settings and control of voltage applied to touch panel
- Sampling of X-coordinate and Y-coordinate data
- Variable coordinate data sampling interval
- Interrupt is triggered if pen touch occurs regardless of CPU operation mode (interrupts do not occur when in CPU hibernate mode)
- Four dedicated buffers for up to two pages each of coordinate data
- Four buffers for A/D port scan
- Auto/manual options for coordinate data sampling start/stop control

19.1.1 Block Diagrams

Figure 19-1. PIU Peripheral Block Diagram

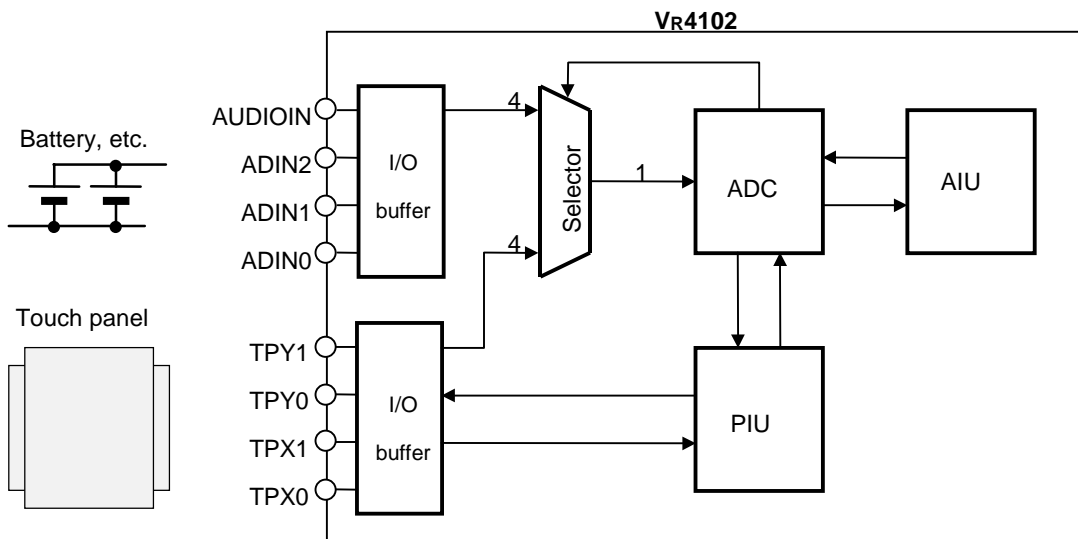

• Touch panel

A set of four pins are located at the edges of the X-axis and Y-axis resistance layers, and the two layers have high resistance when there is no pen contact and low resistance when there is pen contact. The resistance between the two edges of the resistance layers is about 1 kΩ. When a voltage is applied to both edges of the Y-axis resistance layer, the voltage (V_{Y1} and V_{Y2} in the figure below) is measured at the X-axis resistance layer's pins to determine the Y coordinate. Similarly, when a voltage is applied to both edges of the X-axis resistance layer, the voltage (V_{X1} and V_{X2} in the figure below) is measured at the Y-axis resistance layer's pins to determine the X coordinate. For greater precision, voltage applied to individual resistance-layer pins can be measured to obtain X and Y coordinate data based on four voltage measurements. The obtained coordinate data are stored to PIUPBnmREG register ($n = 0, 1, m = 0$ to 3).

Figure 19-2. Equivalent Circuit of Coordinate Detection

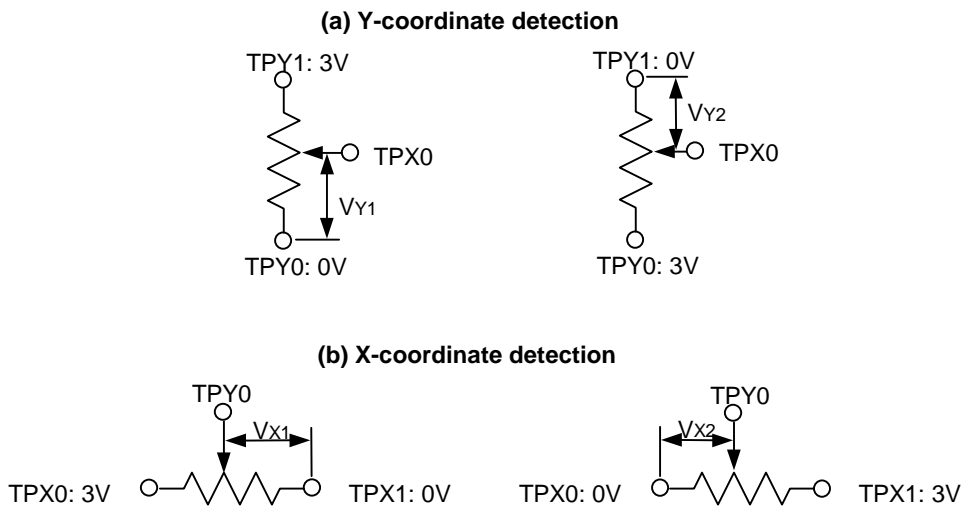
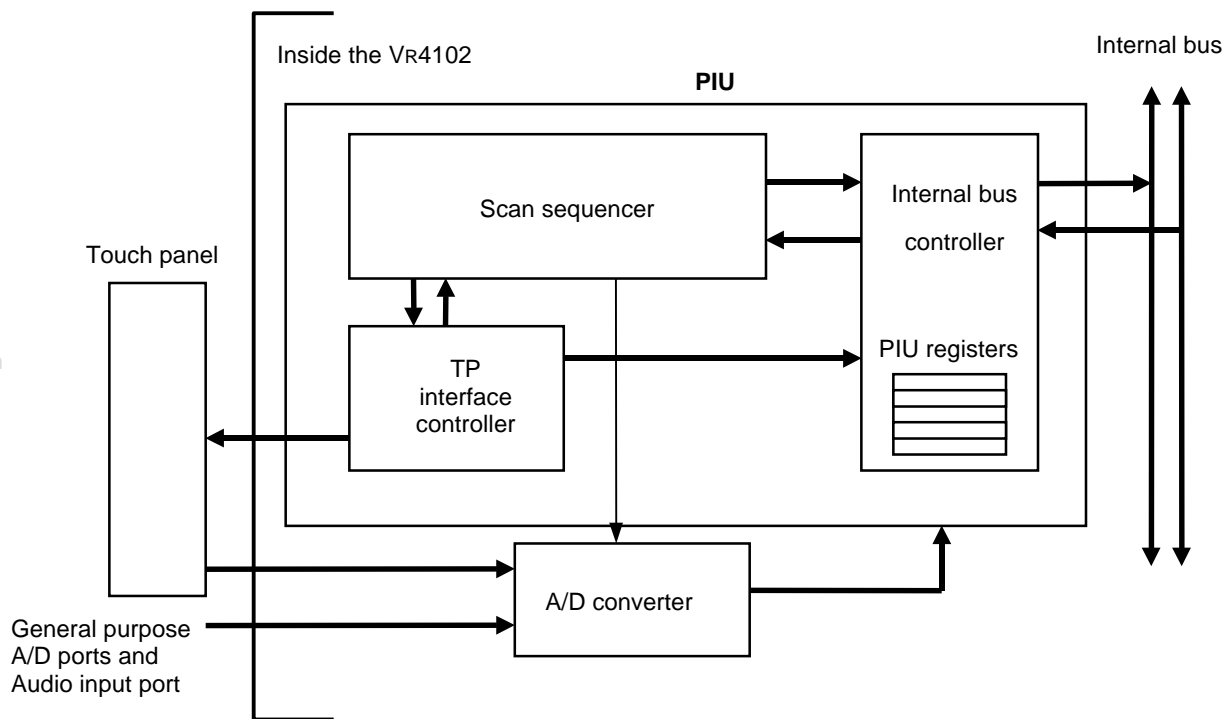

Figure 19-3. Internal Block Diagram of PIU



The PIU includes three blocks: an internal bus controller, a scan sequencer, and a TP interface controller.

- **Internal bus controller**
The internal bus controller controls the internal bus, DMA, the PIU registers, and interrupts and performs serial/parallel conversion of data from the A/D converter.
- **Scan sequencer**
The scan sequencer is used for PIU state management.
- **TP interface controller**
The TP interface controller is used to control the touch panel.

19.2 SCAN SEQUENCER STATE TRANSITION

Figure 19-4. Scan Sequencer State Transition Diagram

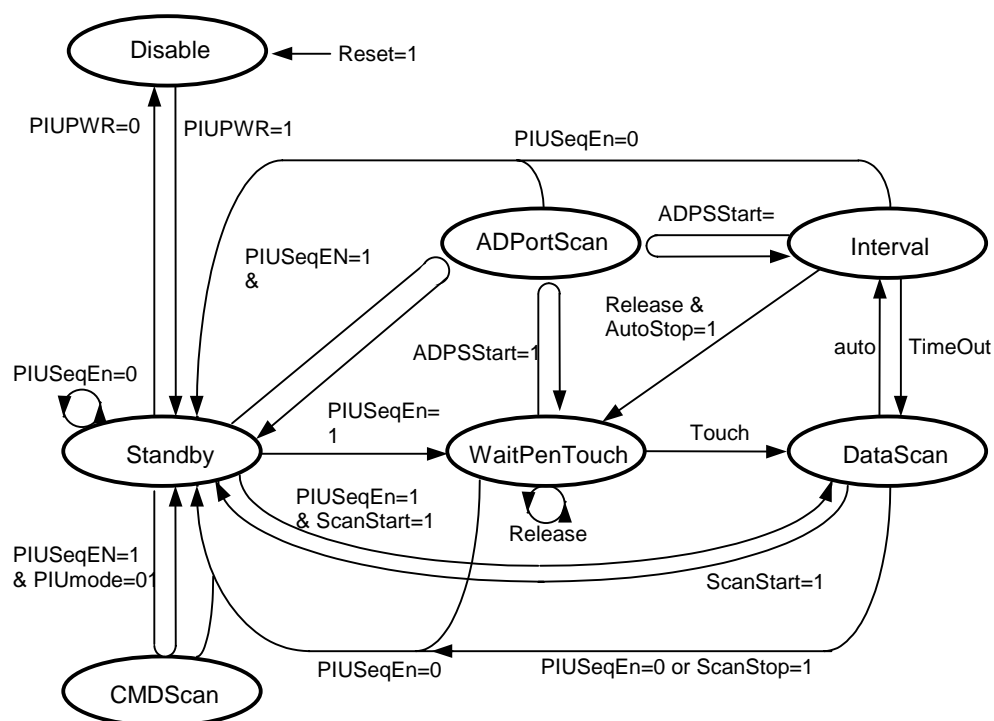

- **Disable state**
In this state, the A/D converter is in standby mode, the output pins are in touch detection mode (no PIU interrupt), and the input pins are in mask mode (to prevent misoperation when an undefined input is applied).
- **Standby state**
In this state, the unit is in scan idle mode. The touch panel is in low-power mode (0-V voltage is applied to the touch panel and the A/D converter is in disable mode). Normally, this is the state from which various mode settings are made.

Caution State transitions occur when the PIUSEQEN bit is active, so the PIUSEQEN bit must be set as active after each mode setting has been completed.

- **ADPortScan state**
This is the state in which voltage is measured at the three A/D converter's general-purpose ports and one audio input port. After the A/D converter is activated and voltage data is obtained, the data is stored in the PIU's internal data buffer (PIUABxREG). After the four ports are scanned, a PadCMDIntr interrupt occurs. After this interrupt occurs, the ADPSSTART bit is automatically set as inactive and the state changes to the state in which the ADPSSTART bit was active.

- CMDScan state

When in this state, the A/D converter operates using various settings. Voltage data from one port only is fetched based on a combination of the touch panel pin setting (TPX[1:0], TPY[1:0]) and the selection of an input port (TPX[1:0], TPY[1:0], AUDIOIN, ADIN[2:0]) to the A/D converter. Use PIUCMDREG to make the touch panel pin setting and to select the input port.

- WaitPenTouch state

This is the standby state that waits for a touch panel “touch” state. When the PIU detects a touch panel “touch” state, PenChgIntr (an internal interrupt in the PIU) occurs. At this point, if the PADAUTOSCAN bit is active, the state changes to the PenDataScan state. During the WaitPenTouch state, it is possible to change to Suspend mode because the panel state can be detected even when TClock has been stopped.

- PenDataScan state

This is the state in which touch panel coordinates are detected. The A/D converter is activated and the four sets of data for each coordinate are sampled.

Caution If one complete pair of coordinates is not obtained during the interval between one pair of coordinates and the next coordinate data, a PadDataLostIntr interrupt occurs.

- IntervalNextScan state

This is the standby state that waits for the next coordinate sampling period or a touch panel “release” state. After the touch panel state is detected, the time period specified via PIUSIVLREG elapses before the transition to the PenDataScan state. If the PIU detects a “release” state within the specified time period, PenChgIntr (an internal interrupt in the PIU) occurs. At this point, the state changes to the WaitPenTouch state if the PADATSTOP bit is active. If the PADATSTOP bit is inactive, it changes to the PenDataScan state after the specified time period has elapsed.

19.3 REGISTER SET

The PIU registers are listed below.

Table 19-1. PIU Registers

Address	R/W	Register symbols	Function
0x0B00 0122	R/W	PIUCNTREG	PIU Control register
0x0B00 0124	R/W	PIUINTREG	PIU Interrupt cause register
0x0B00 0126	R/W	PIUSIVLREG	PIU Data sampling interval register
0x0B00 0128	R/W	PIUSTBLREG	PIU A/D converter start delay register
0x0B00 012A	R/W	PIUCMDREG	PIU A/D command register
0x0B00 0130	R/W	PIUASCNREG	PIU A/D port scan register
0x0B00 0132	R/W	PIUAMSKREG	PIU A/D scan mask register
0x0B00 013E	R	PIUCIVLREG	PIU Check interval register
0x0B00 02A0	R/W	PIUPB00REG	PIU Page 0 Buffer 0 register
0x0B00 02A2	R/W	PIUPB01REG	PIU Page 0 Buffer 1 register
0x0B00 02A4	R/W	PIUPB02REG	PIU Page 0 Buffer 2 register
0x0B00 02A6	R/W	PIUPB03REG	PIU Page 0 Buffer 3 register
0x0B00 02A8	R/W	PIUPB10REG	PIU Page 1 Buffer 0 register
0x0B00 02AA	R/W	PIUPB11REG	PIU Page 1 Buffer 1 register
0x0B00 02AC	R/W	PIUPB12REG	PIU Page 1 Buffer 2 register
0x0B00 02AE	R/W	PIUPB13REG	PIU Page 1 Buffer 3 register
0x0B00 02B0	R/W	PIUAB0REG	PIU A/D scan Buffer 0 register
0x0B00 02B2	R/W	PIUAB1REG	PIU A/D scan Buffer 1 register
0x0B00 02B4	R/W	PIUAB2REG	PIU A/D scan Buffer 2 register
0x0B00 02B6	R/W	PIUAB3REG	PIU A/D scan Buffer 3 register
0x0B00 02BC	R/W	PIUPB04REG	PIU Page 0 Buffer 4 register
0x0B00 02BE	R/W	PIUPB14REG	PIU Page 1 Buffer 4 register

These registers are described in detail below.

19.3.1 PIUCNTREG (0x0B00 0122)

(1/2)

Bit	D15	D14	D13	D12	D11	D10	D9	D8
Name	Reserved	PENSTP	PENSTC	PADSTATE[2]	PADSTATE[1]	PADSTATE[0]	PADATSTOP	PADATSTART
R/W	R	R/W	R	R	R	R	R/W	R/W
RTCRST	0	0	0	0	0	0	0	0
Other resets	0	0	0	0	0	0	0	0

Bit	D7	D6	D5	D4	D3	D2	D1	D0
Name	PADSCAN STOP	PADSCAN START	PADSCAN TYPE	PIUMODE[1]	PIUMODE[0]	PIUSEQEN	PIUPWR	PADRST
R/W	R/W	R/W	R/W	R/W	R/W	R/W	R/W	W
RTCRST	0	0	0	0	0	0	0	0
Other resets	0	0	0	0	0	0	0	0

Bit	Name	Function
D[15]	Reserved	Write 0 when writing. 0 is returned after a read.
D[14]	PENSTP	Previous touch panel contact state 1 : Touch 0 : Release
D[13]	PENSTC	Current touch panel contact state 1 : Touch 0 : Release
D[12..10]	PADSTATE[2:0]	Scan sequencer status 111 : CmdScan 110 : IntervalNextScan 101 : PenDataScan 100 : WaitPenTouch 011 : RFU 010 : ADPortScan 001 : Standby 000 : Disable
D[9]	PADATSTOP	Sequencer auto stop setting during touch panel release state 1 : Auto stop after sampling data for one set of coordinates during release state 0 : No auto stop (even during release state)
D[8]	PADATSTART	Sequencer auto start setting during touch panel touch state 1 : Auto start during touch state 0 : No auto start during touch state
D[7]	PADSCANSTOP	Forced stop setting for touch panel sequencer 1 : Forced stop after sampling data for one set of coordinates 0 : Do not stop

Bit	Name	Function
D[6]	PADSCANSTART	Start setting for touch panel sequencer 1 : Forced start 0 : Do not start
D[5]	PADSCANTYPE	Touch pressure sampling enable 1: Enable 0: Prohibit
D[4..3]	PIUMODE[1..0]	PIU mode setting 11 : RFU 10 : RFU 01 : Operate A/D converter using any command 00 : Sample coordinate data
D[2]	PIUSEQEN	Scan sequencer operation enable 1 : Enable 0 : Prohibit
D[1]	PIUPWR	PIU power mode setting 1 : Set PIU output as active and change to standby mode 0 : Set panel to touch detection state and set PIU operation stop enabled mode
D[0]	PADRST	PIU reset. Once the PADRST bit is set to "1", it is automatically cleared to 0 after four TClock cycles. 1 : Reset 0 : Normal

This register is used to make various settings for the PIU.

Some bits in this register cannot be set in a specific state of scan sequencer. The combination of the setting of this register and the sequencer state is as follows.

Table 19-2. PIUCNTREG Bit Manipulation and States

PIUCNTREG bit manipulation		Scan sequencer's state			
		Disable	Standby	WaitPenTouch	PenData Scan
PADRST ^{Note 1}	0 → 1	–	Disable	Disable	Disable
PIUPWR	0 → 1	Standby	?	×	×
	1 → 0	?	Disable	×	×
PIUSEQEN	0 → 1	×	WaitPenTouch	?	?
	1 → 0	?	?	Standby	Standby
PADATSTART	0 → 1	×	–	PenDataScan ^{Note 2}	×
	1 → 0	×	–	–	×
PADATSTOP	0 → 1	×	–	×	×
	1 → 0	×	–	×	×
PADSCANSTART	0 → 1	×	PenDataScan ^{Note 3}	×	×
	1 → 0	×	–	×	×
PADSCANSTOP	0 → 1	×	–	×	Standby ^{Note 4}
	1 → 0	×	–	×	–

PIUCNTREG bit manipulation		Scan sequencer's state		
		IntervalNextScan	ADPortScan	CmdScan
PADRST ^{Note 1}	0 → 1	Disable	Disable	Disable
PIUPWR	0 → 1	?	?	?
	1 → 0	×	×	×
PIUSEQEN	0 → 1	?	?	?
	1 → 0	Standby	Standby	Standby
PADATSTART	0 → 1	×	×	×
	1 → 0	×	×	×
PADATSTOP	0 → 1	×	×	×
	1 → 0	×	×	×
PADSCANSTART	0 → 1	×	×	×
	1 → 0	×	×	×
PADSCANSTOP	0 → 1	Standby	Standby ^{Note 4}	Standby ^{Note 4}
	1 → 0	?	–	–

- Notes 1.** After “1” is written, the bit is automatically cleared to 0 after four TClock cycles.
- 2.** State transition occurs during touch state
- 3.** State transition occurs when PIUSEQEN = 1
- 4.** State transition occurs after one set of data is sampled. This bit is cleared to 0 after the state transition occurs.

Remarks – : The bit change is retained but there is no state transition.
 × : Setting prohibited (operation not guaranteed)
 ? : Combination of state and bit status before setting does not exist

19.3.2 PIUINTREG (0x0B00 0124)

Bit	D15	D14	D13	D12	D11	D10	D9	D8
Name	OVP	Reserved	Reserved	Reserved	Reserved	Reserved	Reserved	Reserved
R/W	R/W	R	R	R	R	R	R	R
RTCRST	0	0	0	0	0	0	0	0
Other resets	0	0	0	0	0	0	0	0

Bit	D7	D6	D5	D4	D3	D2	D1	D0
Name	Reserved	PADCMD INTR	PADADP INTR	PADPAGE1 INTR	PADPAGE0 INTR	PADDLOST INTR	Reserved	PENCHG INTR
R/W	R	R/W	R/W	R/W	R/W	R/W	R	R/W
RTCRST	0	0	0	0	0	0	0	0
Other resets	0	0	0	0	0	0	0	0

Bit	Name	Function
D[15]	OVP	Valid page ID bit (older valid page) 1 : Valid data older than page 1 buffer data is retained 0 : Valid data older than page 0 buffer data is retained
D[14..7]	Reserved	Write 0 when writing. 0 is returned after a read.
D[6]	PADCMDINTR	PIU command scan interrupt. Cleared to 0 when 1 is written. 1 : Indicates that command scan found valid data 0 : Indicates that command scan did not find valid data in buffer
D[5]	PADADPINTR	PIU A/D port scan interrupt . Cleared to 0 when 1 is written. 1 : Indicates that A/D port scan found valid data with "1" value in buffer 0 : Indicates that A/D port scan did not find valid data with "1" value in buffer
D[4]	PADPAGE1INTR	PIU data buffer page 1 interrupt. Cleared to 0 when 1 is written. 1 : Valid data with "1" value is stored in page 1 of data buffer 0 : No valid data with "1" value in page 1 of data buffer
D[3]	PADPAGE0INTR	PIU data buffer page 0 interrupt. Cleared to 0 when 1 is written. 1 : Valid data with "1" value is stored in page 0 of data buffer 0 : No valid data with "1" value in page 0 of data buffer
D[2]	PADDLOSTINTR	A/D data timeout. Cleared to 0 when 1 is written. 1 : Not data with "1" value found within specified time 0 : No timeout
D[1]	Reserved	Write 0 when writing. 0 is returned after a read.
D[0]	PENCHGINTR	Change in touch panel contact state. Cleared to 0 when 1 is written. 1 : Change has occurred 0 : No change

This register is used to set or indicate an occurrence of PIU's various interrupt requests.

19.3.3 PIUSIVLREG (0x0B00 0126)

Bit	D15	D14	D13	D12	D11	D10	D9	D8
Name	Reserved	Reserved	Reserved	Reserved	Reserved	SCANINT VAL[10]	SCANINT VAL[9]	SCANINT VAL[8]
R/W	R	R	R	R	R	R/W	R/W	R/W
RTCRST	0	0	0	0	0	0	0	0
Other resets	0	0	0	0	0	0	0	0

Bit	D7	D6	D5	D4	D3	D2	D1	D0
Name	SCANINT VAL[7]	SCANINT VAL[6]	SCANINT VAL[5]	SCANINT VAL[4]	SCANINT VAL[3]	SCANINT VAL[2]	SCANINT VAL[1]	SCANINT VAL[0]
R/W	R/W	R/W	R/W	R/W	R/W	R/W	R/W	R/W
RTCRST	0	0	0	0	0	1	1	1
Other resets	0	0	0	0	0	1	1	1

Bit	Name	Function
D[15..11]	Reserved	Write 0 when writing. 0 is returned after a read.
D[10..0]	SCANINTVAL[10..0]	Coordinate data scan sampling interval setting Interval = SCANINTVAL[10..0] x 30 μ s

This register sets the sampling interval for coordinate data sampling.

The sampling interval for one pair of coordinate data is the value set via SCANINTVAL[10..0] multiplied by 30 μ s. Accordingly, the logical range of sampling intervals that can be set in 30- μ s units is from 0 μ s to 60,810 μ s (about 60 ms). Actually, if the sampling interval setting is shorter than the time required for obtaining a pair of coordinate data or ADPortScan data, a PIULostIntr interrupt will occur. If PIULostIntr interrupts occur frequently, set a longer interval time.

Figure 19-5. Interval Times and States

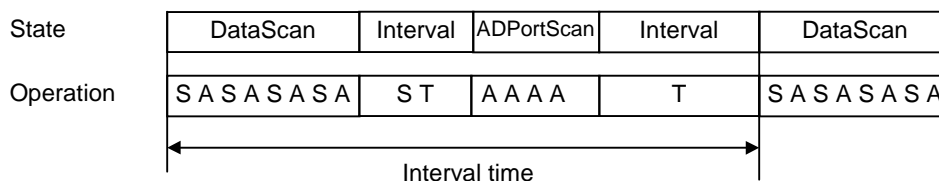

Remarks S : Voltage stabilization standby time (STABLE(5:0) in PIUSTBLREG)
 A : A/D converter's conversion time (about 10 μ s)
 T : Touch/release detection

19.3.4 PIUSTBLREG (0x0B00 0128)

Bit	D15	D14	D13	D12	D11	D10	D9	D8
Name	Reserved	Reserved	Reserved	Reserved	Reserved	Reserved	Reserved	Reserved
R/W	R	R	R	R	R	R	R	R
RTCRST	0	0	0	0	0	0	0	0
Other resets	0	0	0	0	0	0	0	0

Bit	D7	D6	D5	D4	D3	D2	D1	D0
Name	Reserved	Reserved	STABLE[5]	STABLE[4]	STABLE[3]	STABLE[2]	STABLE[1]	STABLE[0]
R/W	R	R	R/W	R/W	R/W	R/W	R/W	R/W
RTCRST	0	0	0	0	0	1	1	1
Other resets	0	0	0	0	0	1	1	1

Bit	Name	Function
D[15..6]	Reserved	Write 0 when writing. 0 is returned after a read.
D[5..0]	STABLE[5..0]	Panel applied voltage stabilization standby time Standby time = STABLE[5..0] × 30 μs During A/D scan, this can be used as a timeout counter.

The voltage stabilization standby time for the voltage applied to the touch panel can be set via STABLE[5..0] in 30-μs units between 0 μs and 1,890 μs.

The setting of this register is also used as a timeout period during A/D scan.

19.3.5 PIUCMDREG (0x0B00 012A)

(1/2)

Bit	D15	D14	D13	D12	D11	D10	D9	D8
Name	Reserved	Reserved	Reserved	STABLEON	TPYEN1	TPYEN0	TPXEN1	TPXEN0
R/W	R	R	R	R/W	R/W	R/W	R/W	R/W
RTCRST	0	0	0	0	0	0	0	0
Other resets	0	0	0	0	0	0	0	0

Bit	D7	D6	D5	D4	D3	D2	D1	D0
Name	TPYD1	TPYD0	TPXD1	TPXD0	ADCMD[3]	ADCMD[2]	ADCMD[1]	ADCMD[0]
R/W	R/W	R/W	R/W	R/W	R/W	R/W	R/W	R/W
RTCRST	0	0	0	0	1	1	1	1
Other resets	0	0	0	0	1	1	1	1

Bit	Name	Function
D[15..13]	Reserved	Write 0 when writing. 0 is returned after a read.
D[12]	STABLEON	Touch panel applied voltage stabilization time set (STABLE[5..0] of PIUSTBLREG) enable 1 : Retain panel voltage stabilization time 0 : Ignore panel voltage stabilization time (voltage stabilization standby time = 0)
D[11..10]	TPYEN[1..0]	TPY port input/output switching during command scan 00 : TPY1 input, TPY0 input 01 : TPY1 input, TPY0 output 10 : TPY1 output, TPY0 input 11 : TPY1 output, TPY0 output
D[9..8]	TPXEN[1..0]	TPX port input/output switching during command scan 00 : TPX1 input, TPX0 input 01 : TPX1 input, TPX0 output 10 : TPX1 output, TPX0 input 11 : TPX1 output, TPX0 output
D[7..6]	TPYD[1..0]	TPY output level during command scan 00 : TPY1 = "L", TPY0 = "L" 01 : TPY1 = "L", TPY0 = "H" 10 : TPY1 = "H", TPY0 = "L" 11 : TPY1 = "H", TPY0 = "H" TPYD value is ignored when TPYEN is set for input.
D[5..4]	TPXD[1..0]	TPX output level during command scan 00 : TPX1 = "L", TPX0 = "L" 01 : TPX1 = "L", TPX0 = "H" 10 : TPX1 = "H", TPX0 = "L" 11 : TPX1 = "H", TPX0 = "H" TPXD value is ignored when TPXEN is set for input.

Bit	Name	Function
D[3..0]	ADCMD[3..0]	A/D converter input port selection for command scan 1111 : A/D converter standby mode request 1110 : RFU : 1000 : RFU 0111 : AUDIOIN port 0110 : ADIN2 port 0101 : ADIN1 port 0100 : ADIN0 port 0011 : TPY1 port 0010 : TPY0 port 0001 : TPX1 port 0000 : TPX0 port

This register sets the switching or output level of ports during command scan operation.

19.3.6 PIUASCNREG (0x0B00 0130)

Bit	D15	D14	D13	D12	D11	D10	D9	D8
Name	Reserved	Reserved	Reserved	Reserved	Reserved	Reserved	Reserved	Reserved
R/W	R	R	R	R	R	R	R	R
RTCRST	0	0	0	0	0	0	0	0
Other resets	0	0	0	0	0	0	0	0

Bit	D7	D6	D5	D4	D3	D2	D1	D0
Name	Reserved	Reserved	Reserved	Reserved	Reserved	Reserved	TPPSCAN	ADPS START
R/W	R	R	R	R	R	R	R/W	R/W
RTCRST	0	0	0	0	0	0	0	0
Other resets	0	0	0	0	0	0	0	0

Bit	Name	Function
D[15..2]	Reserved	Write 0 when writing. 0 is returned after a read.
D[1]	TPPSCAN	Port selection for ADPortScan 1 : Select TPX[1:0], TPY[1:0] (for touch panel) as A/D port 0 : Select ADIN[3:0] (general-purpose) as A/D port
D[0]	ADPSSTART	ADPorScan start 1 : Start ADPortScan 0 : Do not perform ADPortScan

The ADPortScan begins when the ADPSSTART bit is set. After the ADPortScan is completed, the state returns to the state when ADPortScan was started. Automatically ADPSSTART bit is reset (to "0") after ADPortScan is completed.

If the ADPortScan is not completed within the time period set via PIUSTBLREG's STABLE bits, a PIULostIntr interrupt occurs as a timeout interrupt.

Some bits in this register cannot be set in a specific state of scan sequencer. The combination of the setting of this register and the sequencer state is as follows.

Table 19-3. PIUASCNREG Bit Manipulation and States

PIUASCNREG bit manipulation		Scan sequencer's state			
		Disable	Standby	WaitPenTouch	PenData Scan
ADDSTART	0 → 1	×	ADPortScan ^{Note}	×	×
	1 → 0	×	Disable	×	×
TPPSCAN	0 → 1	–	–	–	–
	1 → 0	–	–	–	–

PIUCNTREG bit manipulation		Scan sequencer's state		
		IntervalNextScan	ADPortScan	CmdScan
ADDSTART	0 → 1	×	ADPortScan ^{Note}	×
	1 → 0	×	Disable	×
TPPSCAN	0 → 1	×	WaitPenTouch	?
	1 → 0	?	?	Standby

Note After ADPortScan is completed, the bit is automatically cleared to 0.

Remarks – : The bit change is retained but there is no state transition.

× : Setting prohibited (operation not guaranteed)

? : Combination of state and bit status before setting does not exist

19.3.7 PIUAMSKREG (0x0B00 0132)

Bit	D15	D14	D13	D12	D11	D10	D9	D8
Name	Reserved	Reserved	Reserved	Reserved	Reserved	Reserved	Reserved	Reserved
R/W	R	R	R	R	R	R	R	R
RTCRST	0	0	0	0	0	0	0	0
Other resets	0	0	0	0	0	0	0	0

Bit	D7	D6	D5	D4	D3	D2	D1	D0
Name	ADINM3	ADINM2	ADINM1	ADINM0	TPYM1	TPYM0	TPXM1	TPXM0
R/W	R/W	R/W	R/W	R/W	R/W	R/W	R/W	R/W
RTCRST	0	0	0	0	0	0	0	0
Other resets	0	0	0	0	0	0	0	0

Bit	Name	Function
D[15..8]	Reserved	Write 0 when writing. 0 is returned after a read.
D[7]	ADINM[3]	Audio input port mask Valid only during A/D scan. If masked, A/D conversions are not performed for the corresponding port.
D[6..4]	ADINM[2..0]	General-purpose A/D port mask Valid only during A/D scan. If masked, A/D conversions are not performed for the corresponding port. 1 : Mask 0 : Normal
D[3..2]	TPYM[1..0]	Touch panel A/D port TPY mask Valid only during A/D scan. If masked, A/D conversions are not performed for the corresponding port. 1 : Mask 0 : Normal
D[1..0]	TPXM[1..0]	Touch panel A/D port TPX mask Valid only during A/D scan. If masked, A/D conversions are not performed for the corresponding port. 1 : Mask 0 : Normal

This register is used to set masking of each A/D port. Its setting is valid only during A/D Port scanning operation.

19.3.8 PIUCIVLREG (0x0B00 013E)

Bit	D15	D14	D13	D12	D11	D10	D9	D8
Name	Reserved	Reserved	Reserved	Reserved	Reserved	CHECKIN TVAL[10]	CHECKIN TVAL[9]	CHECKIN TVAL[8]
R/W	R	R	R	R	R	R	R	R
RTCRST	0	0	0	0	0	0	0	0
Other resets	0	0	0	0	0	0	0	0

Bit	D7	D6	D5	D4	D3	D2	D1	D0
Name	CHECKIN TVAL[7]	CHECKIN TVAL[6]	CHECKIN TVAL[5]	CHECKIN TVAL[4]	CHECKIN TVAL[3]	CHECKIN TVAL[2]	CHECKIN TVAL[1]	CHECKIN TVAL[0]
R/W	R	R	R	R	R	R	R	R
RTCRST	0	0	0	0	0	0	0	0
Other resets	0	0	0	0	0	0	0	0

Bit	Name	Function
D[15..11]	Reserved	Write 0 when writing. 0 is returned after a read.
D[10..0]	CHKINTVAL[10..0]	Interval count value

This register is used for real-time reading of internal register values being counted down based on the PIUSIVLREG setting.

19.3.9 PIUPBnmREG (0x0B00 02A0 to 0x0B00 02AE, 0x0B00 02BC to 0x0B00 02BE)

Remark n = 0, 1, m = 0 to 4

PIUPB00REG (0x0B00 02A0)	PIUPB04REG (0x0B00 02BC)	PIUPB13REG (0x0B00 02AE)
PIUPB01REG (0x0B00 02A2)	PIUPB10REG (0x0B00 02A8)	PIUPB14REG (0x0B00 02BE)
PIUPB02REG (0x0B00 02A4)	PIUPB11REG (0x0B00 02AA)	
PIUPB03REG (0x0B00 02A6)	PIUPB12REG (0x0B00 02AC)	

Bit	D15	D14	D13	D12	D11	D10	D9	D8
Name	VALID	Reserved	Reserved	Reserved	Reserved	Reserved	PADDDATA[9]	PADDDATA[8]
R/W	R/W	R	R	R	R	R	R/W	R/W
RTCRST	0	0	0	0	0	0	0	0
Other resets	0	0	0	0	0	0	0	0

Bit	D7	D6	D5	D4	D3	D2	D1	D0
Name	PADDDATA[7]	PADDDATA[6]	PADDDATA[5]	PADDDATA[4]	PADDDATA[3]	PADDDATA[2]	PADDDATA[1]	PADDDATA[0]
R/W	R/W	R/W	R/W	R/W	R/W	R/W	R/W	R/W
RTCRST	0	0	0	0	0	0	0	0
Other resets	0	0	0	0	0	0	0	0

Bit	Name	Function
D[15]	VALID	Indicates validity of data in PADDDATA 1 : Valid 0 : Invalid
D[14..10]	Reserved	Write 0 when writing. 0 is returned after a read.
D[9..0]	PADDDATA[9..0]	A/D converter's sampling data

This register is used to store coordinate data and touch pressure data. There are four coordinate data buffers and one pair of touch pressure data buffer, each of which holds two pages of coordinate data or pressure data, and the addresses (register addresses) where the coordinate data or the pressure data is stored are fixed. Read coordinate data from the corresponding register in a valid page.

The VALID bit, which indicates when the data is valid, is automatically rendered invalid when the page buffer interrupt cause (PIUPAGE0INTR or PIUPAGE1INTR in PIUINTREG) is cleared.

Table 19-4. Detected Coordinates and Page Buffers

Detected data	Page0 Buffer	Page1 Buffer
X+	PIUPB00REG	PIUPB10REG
X-	PIUPB01REG	PIUPB11REG
Y+	PIUPB02REG	PIUPB12REG
Y-	PIUPB03REG	PIUPB13REG
Z (Touch pressure)	PIUPB04REG	PIUPB14REG

19.3.10 PIUABnREG (0x0B00 02B0 to 0x0B00 02B6)

Remark n = 0 to 3
 PIUAB0REG (0x0B00 02B0)
 PIUAB1REG (0x0B00 02B2)
 PIUAB2REG (0x0B00 02B4)
 PIUAB3REG (0x0B00 02B6)

Bit	D15	D14	D13	D12	D11	D10	D9	D8
Name	VALID	Reserved	Reserved	Reserved	Reserved	Reserved	PADDATA[9]	PADDATA[8]
R/W	R/W	R	R	R	R	R	R/W	R/W
RTCRST	0	0	0	0	0	0	0	0
Other resets	0	0	0	0	0	0	0	0

Bit	D7	D6	D5	D4	D3	D2	D1	D0
Name	PADDATA[7]	PADDATA[6]	PADDATA[5]	PADDATA[4]	PADDATA[3]	PADDATA[2]	PADDATA[1]	PADDATA[0]
R/W	R/W	R/W	R/W	R/W	R/W	R/W	R/W	R/W
RTCRST	0	0	0	0	0	0	0	0
Other resets	0	0	0	0	0	0	0	0

Bit	Name	Function
D[15]	VALID	Indicates validity of data in PADDATA 1 : Valid 0 : Invalid
D[14..10]	Reserved	Write 0 when writing. 0 is returned after a read.
D[9..0]	PADDATA[9..0]	A/D converter's sampling data

This register is used to store general-purpose A/D port sampling data, audio input port sampling data, and command scan data. There are four data buffers and the addresses (register address) where the data is stored are fixed.

The VALID bit, which indicates when the data is valid, is automatically rendered invalid when the page buffer interrupt cause (PIUADPINTR in PIUINTREG) is cleared.

Table 19-5. A/D Ports and Data Buffers

Register	During ADPortScan		During CMDScan
	TPPScan = 0	TPPScan = 1	
PIUAB0REG	ADIN0	TPX0	CMDScanDATA
PIUAB1REG	ADIN1	TPX1	–
PIUAB2REG	ADIN2	TPY0	–
PIUAB3REG	AUDIOIN	TPY1	–

19.4 REGISTER SETTING FLOW

Be sure to reset the PIU before operating the scan sequencer. Setting initial values via a reset sets particular values for the sequence interval, etc., that are required.

The registers for which these initial settings are necessary are listed below.

PIUSITVLREG ScanIntval [10:0]
 PIUSTBLREG Stable [3:0]

Interrupt mask cancellation settings are required for registers other than the PIU registers.

Setting	Unit	Register	Bit	Value
Interrupt mask clear	ICU	MSYSINTREG	PIUINTR	1
	ICU	MPIUINTREG	bit 6:0	0x7F
Clock mask clear	CMU	CMUCLKMSK	MSKPIU	1

(1) Register setting flow for voltage detection at A/D general-purpose ports and audio input port

Standby, WaitPenTouch, or Interval state

<1> PIUAMSKREG AD port and audio input port mask setting

<2> PIUASCNREG ADPSSTART = 1

↓

ADPortScan state

<3> PIUASCNREG ADPSSTART = 0

↓

Standby, WaitPenTouch, or Interval state

(2) Register setting flow for auto scan coordinate detection

Standby state

<1> PIUCNTREG PIUMode [1:0] = 00

PADATSCAN = 1

PADATSTOP = 1

<2> PIUCNTREG PIUSEQEN = 1

↓

WaitPenTouch state

(3) Register setting flow for manual scan coordinate detection

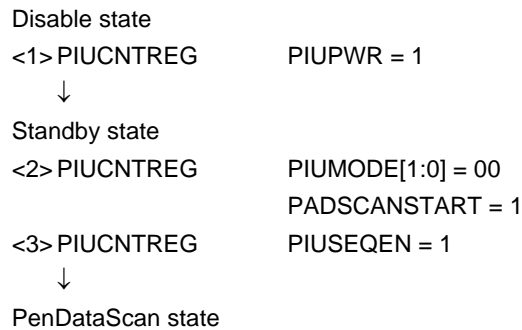

(4) Register setting flow during Suspend mode transition

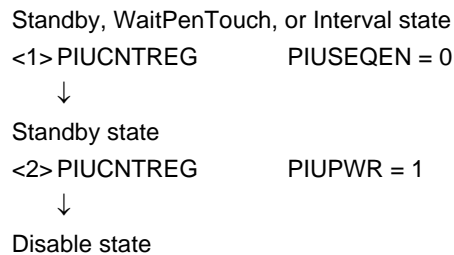

(5) Register setting flow when returning from Suspend mode transition

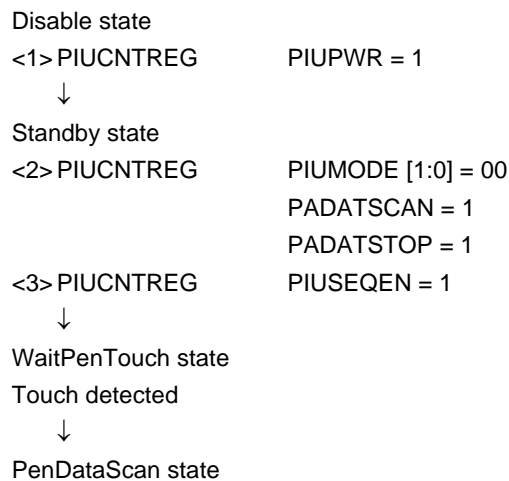

(6) Register setting flow for command scan

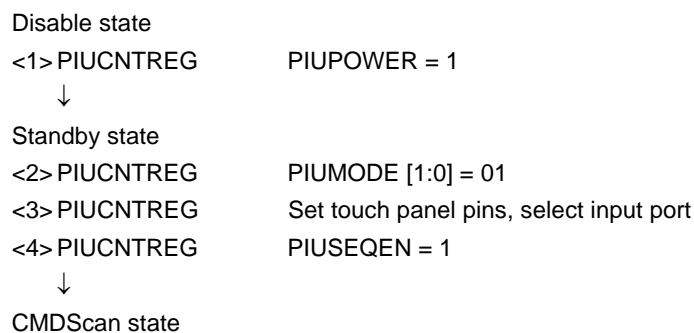

19.5 RELATIONSHIPS AMONG TPX, TPY, AND ADIN PINS AND STATES

State	PadState[2:0]	TPX[1:0]	TPY[1:0]	ADIN[2:0] AUDIOIN
Power off (pen status detection)	Disable	HH	D-	----
Low-power standby	Standby	00	00	----
Pen status detection	WaitPenTouch/Interval	HH	D-	----
Voltage detection at general-purpose AD0 port	ADPortScan	00	00	---I
Voltage detection at general-purpose AD1 port	ADPortScan	00	00	--I-
Voltage detection at general-purpose AD2 port	ADPortScan	00	00	-I--
Voltage detection at audio input port	ADPortScan	00	00	I---
TPY1 = H, TPY0 = L, TPX0 = samp (X+)	PadDataScan	-I	HL	----
TPY1 = L, TPY0 = H, TPX0 = samp (X-)	PadDataScan	-I	LH	----
TPX1 = H, TPX0 = L, TPY0 = samp (Y+)	PadDataScan	HL	-I	----
TPX1 = L, TPX0 = H, TPY0 = samp (Y-)	PadDataScan	LH	-I	----
Touch pressure detection (Z)	PadDataScan	HH	d-	----

Remarks

- 0 : Low level input
- 1 : High level input
- L : Low level output
- H : High level output
- I : A/D converter input
- D : Touch interrupt input (via pull-down resistor)
- d : No touch interrupt input (via pull-down resistor)
- : Don't care

19.6 TIMING

19.6.1 Touch/Release Detection Timing

Touch/release detection does not use the A/D converter but instead uses the voltage level of the TPY1 pin to determine the panel's touch/release state. The following figure shows a touch/release detection timing diagram.

Figure 19-6. Touch/Release Detection Timing

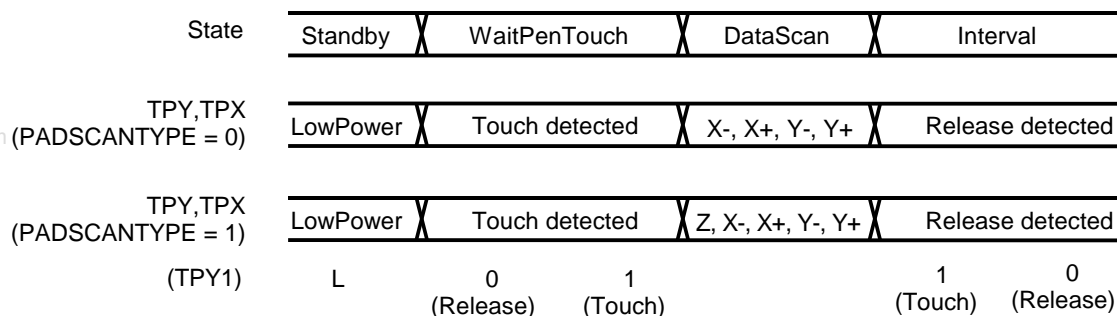

19.6.2 A/D Port Scan Timing

The A/D port scan function sequentially scans the A/D converter's four input channel port pins and stores the data in the data buffer used for A/D port scanning.

The following figure shows an A/D port scan timing diagram.

Figure 19-7. A/D Port Scan Timing

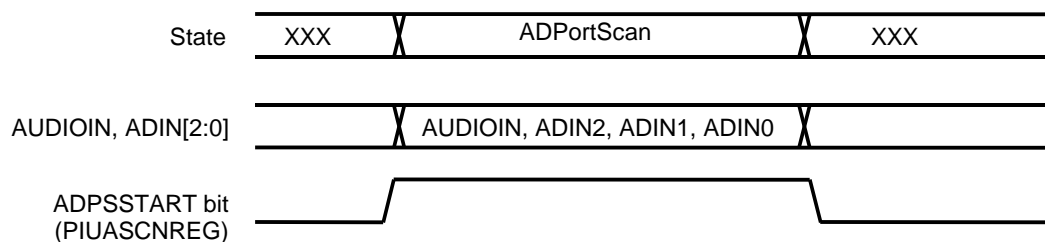

XXX state: Standby, WaitPenTouch, or Interval

19.7 DATA LOSS INTERRUPT CONDITIONS

The PIU issues a PIUDataLostIntr interrupt when any of the following four conditions exist.

Once a PIUDataLostIntr interrupt occurs, the sequencer is forcibly changed to the Standby state.

1. Data for one coordinate has not been obtained within the interval period
2. The A/D port scan has not been completed within the time set via PIUSTBLREG
3. Transfer of the next coordinate data has begun while valid data for both pages remains in the buffer
4. The next data transfer starts while there is valid data in the ADPortScan buffer

(1) When data for one coordinate has not been obtained within the interval period

Cause

This condition occurs when the AIU has exclusive use of the A/D converter and the PIU is therefore unable to use the A/D converter.

If this data loss condition occurs frequently, implement a countermeasure that temporarily prohibits the AIU's use of the A/D converter.

Response

After clearing the cause of the PIUDataLostIntr interrupt, set PIUCIUCNTREG's PADATSTART bit or PADSCANSTART bit to restart the coordinate detection operation. Once the PIUDataLostIntr interrupt is cleared, the page in which the loss occurred becomes invalid. If the valid data prior to the data loss is needed, be sure to save the data that is being stored in the page buffer before clearing the PIUDataLostIntr interrupt.

(2) When the A/D port scan has not been completed within the time set via PIUSTBLREG

Cause

Same as cause of condition 1

Response

After clearing the cause of the PIUDataLostIntr interrupt, set PIUASCNREG's ADPSSTART bit to restart the A/D port scan operation. Once the PIUDataLostIntr interrupt is cleared, the page in which the loss occurred becomes invalid. If the valid data prior to the data loss is needed, be sure to save the data that is being stored in the page buffer before clearing the PIUDataLostIntr interrupt.

(3) When transfer of the next coordinate data has begun while valid data for both pages remains in the buffer

Cause

This condition is caused when the data buffer contains two pages of valid data (both the PIUPAGE1INTR and PIUPAGE0INTR interrupts have occurred) but the valid data has not been processed. If the A/D converter is used frequently, this may shorten the time that would normally be required from when both pages become full until when the data loss occurs.

Response

In condition 3, valid data contained in the pages when the PIUDataLostIntr interrupt occurs is never overwritten.

After two pages of valid data are processed, clear the causes of the three interrupts (PIUDataLostIntr, PIUPAGE1INTR, and PIUPAGE0INTR).

After clearing these interrupt causes, set the PADATSTART bit or PADSCANSTART bit of PIUCNTREG to restart the coordinate detection operation.

(4) When the next data transfer starts while there is valid data in the ADPortScan buffer**Cause**

This condition is caused when valid data is not processed even while the ADPortScan buffer holds valid data (PADADPINTR interrupt occurrence).

Response

In condition 4, valid data contained in the buffer when the PIUDataLostIntr interrupt occurs is never overwritten.

After valid data in the buffer is processed, clear the causes of the two interrupts (PIUDataLostIntr, PADADPINTR).

After clearing these interrupt causes, set the ADPSSTART bit of PIUASCNREG to restart the general-purpose A/D port scan.

19.8 COMPARISON OF VR4102 AND VR4101™

Table 19-6. Comparison of PIUs of VR4102 and VR4101

Item	VR4102	VR4101
A/D converter	On-chip (10 bits)	External (10/12 bits)
Data transfer	Transfer to buffer in PIU	DMA transfer
Data buffers	Four buffers (two pages each) for coordinate data only Four buffers for A/D scan	One buffer
Scan types	Coordinate data scan Command scan A/D scan	Coordinate data scan Command scan Main battery scan Sub battery scan
A/D port scan activation states	Standby, WaitPen Touch, Interval	Standby
Panel applied voltage stabilization standby time counter	6 bits	4 bits
Panel applied voltage during low-voltage mode	All four touch panel pins are at low level	All four touch panel pins are at Hi-Z
Panel state during disable state	Touch detection state (Interrupts do not occur when CPU is in Hibernate mode.)	All four touch panel pins are at Hi-Z
Handling of valid data when data loss occurs	Valid data is always retained	Valid data is overwritten
Data interrupt	Three types of special-purpose interrupts (two coordinate data interrupts, A/D scan interrupt, and command scan interrupt)	Two types of page boundary interrupts
PIUDataRdyIntr	No	Yes

[MEMO]

CHAPTER 20 AIU (AUDIO INTERFACE UNIT)

This chapter describes the AIU's operations and register settings.

20.1 GENERAL

The AIU supports speaker output and MIC input operations. It is also used to set the A/D and D/A converter operations.

20.2 REGISTER SET

The AIU registers are listed below.

Table 20-1. AIU Registers

Address	R/W	Register Symbols	Function
0x0B00 0160	R/W	MDMADATREG	Mike DMA Data Register
0x0B00 0162	R/W	SDMADATREG	Speaker DMA Data Register
0x0B00 0166	R/W	SODATREG	Speaker Output Data Register
0x0B00 0168	R/W	SCNTREG	Speaker Output Control Register
0x0B00 016A	R/W	SCNVRREG	Speaker Conversion Rate Register
0x0B00 0170	R/W	MIDATREG	Mike Input Data Register
0x0B00 0172	R/W	MCNTREG	Mike Input Control Register
0x0B00 0174	R/W	MCNVRREG	Mike Conversion Rate Register
0x0B00 0178	R/W	DVALIDREG	Data Valid Register
0x0B00 017A	R/W	SEQREG	Sequential Register
0x0B00 017C	R/W	INTREG	Interrupt Register

These registers are described in detail below.

20.2.1 MDMADATREG (0x0B00 0160)

Bit	D15	D14	D13	D12	D11	D10	D9	D8
Name	Reserved	Reserved	Reserved	Reserved	Reserved	Reserved	MDMA[9]	MDMA[8]
R/W	R	R	R	R	R	R	R/W	R/W
RTCRST	0	0	0	0	0	0	1	0
Other resets	0	0	0	0	0	0	1	0

Bit	D7	D6	D5	D4	D3	D2	D1	D0
Name	MDMA[7]	MDMA[6]	MDMA[5]	MDMA[4]	MDMA[3]	MDMA[2]	MDMA[1]	MDMA[0]
R/W	R/W	R/W	R/W	R/W	R/W	R/W	R/W	R/W
RTCRST	0	0	0	0	0	0	0	0
Other resets	0	0	0	0	0	0	0	0

Bit	Name	Function
D[15:10]	Reserved	Write 0 when writing. 0 is returned after a read.
D[9:0]	MDMA[9:0]	MIC input DMA data (from MIDATREG to buffer)

This register is used prior to DMA transfer to store 10-bit data that has been converted by the A/D converter and stored in MIDATREG. Write is used for debugging and is enabled when AIUMEN bit of SEQREG is set to 1. This register is cleared (0x0200) by resetting AIUMEN bit of SEQREG to 0.

20.2.2 SDMATREG (0x0B00 0162)

Bit	D15	D14	D13	D12	D11	D10	D9	D8
Name	Reserved	Reserved	Reserved	Reserved	Reserved	Reserved	SDMA[9]	SDMA[8]
R/W	R	R	R	R	R	R	R/W	R/W
RTCRST	0	0	0	0	0	0	1	0
Other resets	0	0	0	0	0	0	1	0

Bit	D7	D6	D5	D4	D3	D2	D1	D0
Name	SDMA[7]	SDMA[6]	SDMA[5]	SDMA[4]	SDMA[3]	SDMA[2]	SDMA[1]	SDMA[0]
R/W	R/W	R/W	R/W	R/W	R/W	R/W	R/W	R/W
RTCRST	0	0	0	0	0	0	0	0
Other resets	0	0	0	0	0	0	0	0

Bit	Name	Function
D[15:10]	Reserved	Write 0 when writing. 0 is returned after a read.
D[9:0]	SDMA[9:0]	Speaker output DMA data (from buffer to SODATREG)

This register is used to store 10-bit DMA data for speaker output. When SODATREG is empty, the data is transferred to SODATREG. Write is used for debugging and is enabled when AIUSEN bit of SEQREG is set to 1. This register is cleared (0x0200) by resetting AIUSEN bit of SEQREG to 0.

20.2.3 SODATREG (0x0B00 0166)

Bit	D15	D14	D13	D12	D11	D10	D9	D8
Name	Reserved	Reserved	Reserved	Reserved	Reserved	Reserved	SODAT[9]	SODAT[8]
R/W	R	R	R	R	R	R	R/W	R/W
RTCRST	0	0	0	0	0	0	1	0
Other resets	0	0	0	0	0	0	1	0

Bit	D7	D6	D5	D4	D3	D2	D1	D0
Name	SODAT[7]	SODAT[6]	SODAT[5]	SODAT[4]	SODAT[3]	SODAT[2]	SODAT[1]	SODAT[0]
R/W	R/W	R/W	R/W	R/W	R/W	R/W	R/W	R/W
RTCRST	0	0	0	0	0	0	0	0
Other resets	0	0	0	0	0	0	0	0

Bit	Name	Function
D[15:10]	Reserved	Write 0 when writing. 0 is returned after a read.
D[9:0]	SODAT[9:0]	Speaker output data (from SDMADATREG to D/A converter)

This register is used to store 10-bit DMA data for speaker output. Data is sent from the D/A converter to SDMADATREG. Write is used for debugging and is enabled when AIUSEN bit of SEQREG is set to 1. This register is cleared (0x0200) by resetting AIUSEN bit of SEQREG to 0.

20.2.4 SCNTREG (0x0B00 0168)

Bit	D15	D14	D13	D12	D11	D10	D9	D8
Name	DAENAIU	Reserved	Reserved	Reserved	Reserved	Reserved	Reserved	Reserved
R/W	R/W	R	R	R	R	R	R	R
RTCRST	0	0	0	0	0	0	0	0
Other resets	0	0	0	0	0	0	0	0

Bit	D7	D6	D5	D4	D3	D2	D1	D0
Name	Reserved	Reserved	Reserved	Reserved	SSTATE	Reserved	SSTOPEN	Reserved
R/W	R	R	R	R	R	R	R/W	R
RTCRST	0	0	0	0	0	0	0	0
Other resets	0	0	0	0	0	0	0	0

Bit	Name	Function
D[15]	DAENAIU	This is the speaker D/A enable bit. It controls the ON/OFF status of the Vref input to the D/A converter's ladder resistors. 1 : Vref ON 0 : Vref OFF
D[14:4]	Reserved	Write 0 when writing. 0 is returned after a read.
D[3]	SSTATE	Indicates speaker operation state 1 : In operation 0 : Stopped
D[2]	Reserved	Write 0 when writing. 0 is returned after a read.
D[1]	SSTOPEN	Speaker output DMA transfer 1-page boundary interrupt stop 1 : Stop DMA request at 1-page boundary 0 : Stop DMA request at 2-page boundary
D[0]	Reserved	Write 0 when writing. 0 is returned after a read.

This register is used to control the AIU's speaker block.

DAENAIU bit controls the connection of DVDD and Vref input to ladder type resistors in the D/A converter. Setting this bit to 0 (OFF) allows low power consumption when not using the D/A converter. When using D/A converter, this bit must be set following the sequence described in 20.3.

The contents of SSTATE bit is valid only when AIUSEN bit of SEQREG is set to 1.

20.2.5 SCNVRREG (0x0B00 016A)

Bit	D15	D14	D13	D12	D11	D10	D9	D8
Name	Reserved	Reserved	Reserved	Reserved	Reserved	Reserved	Reserved	Reserved
R/W	R	R	R	R	R	R	R	R
RTCRST	0	0	0	0	0	0	0	0
Other resets	0	0	0	0	0	0	0	0

Bit	D7	D6	D5	D4	D3	D2	D1	D0
Name	Reserved	Reserved	Reserved	Reserved	Reserved	SCNVR[2]	SCNVR[1]	SCNVR[0]
R/W	R	R	R	R	R	R/W	R/W	R/W
RTCRST	0	0	0	0	0	0	0	0
Other resets	0	0	0	0	0	0	0	0

Bit	Name	Function
D[15:3]	Reserved	Write 0 when writing. 0 is returned after a read.
D[2:0]	SCNVR[2:0]	D/A Conversion Rate 111 : RFU : 101 : RFU 100 : 8 ksps 011 : RFU 010 : 44.1 ksps 001 : 22.05 ksps 000 : 11.025 ksps

This register is used to select a conversion rate for the D/A converter.

20.2.6 MIDATREG (0x0B00 0170)

Bit	D15	D14	D13	D12	D11	D10	D9	D8
Name	Reserved	Reserved	Reserved	Reserved	Reserved	Reserved	MIDAT[9]	MIDAT[8]
R/W	R	R	R	R	R	R	R/W	R/W
RTCRST	0	0	0	0	0	0	1	0
Other resets	0	0	0	0	0	0	1	0

Bit	D7	D6	D5	D4	D3	D2	D1	D0
Name	MIDAT[7]	MIDAT[6]	MIDAT[5]	MIDAT[4]	MIDAT[3]	MIDAT[2]	MIDAT[1]	MIDAT[0]
R/W	R/W	R/W	R/W	R/W	R/W	R/W	R/W	R/W
RTCRST	0	0	0	0	0	0	0	0
Other resets	0	0	0	0	0	0	0	0

Bit	Name	Function
D[15:10]	Reserved	Write 0 when writing. 0 is returned after a read.
D[9:0]	MIDAT[9:0]	MIC input data (from A/D to MDADATREG)

This register is used to store 10-bit speaker input data that has been converted by the A/D converter. Data is sent to MDADATREG and is received from the A/D converter. Write is used for debugging and is enabled when AIUMEN bit of SEQREG is set to 1. This register is cleared (0x0200) by resetting AIUMEN bit of SEQREG to 0.

20.2.7 MCNTREG (0x0B00 0172)

Bit	D15	D14	D13	D12	D11	D10	D9	D8
Name	ADENAIU	Reserved	Reserved	Reserved	Reserved	Reserved	Reserved	Reserved
R/W	R/W	R	R	R	R	R	R	R
RTCRST	0	0	0	0	0	0	0	0
Other resets	0	0	0	0	0	0	0	0

Bit	D7	D6	D5	D4	D3	D2	D1	D0
Name	Reserved	Reserved	Reserved	Reserved	MSTATE	Reserved	MSTOPEN	ADREQAIU
R/W	R	R	R	R	R	R	R/W	R
RTCRST	0	0	0	0	0	0	0	0
Other resets	0	0	0	0	0	0	0	0

Bit	Name	Function
D[15]	ADENAIU	This is the MIC A/D enable bit. It controls the ON/OFF status of the Vref input to the D/A converter's ladder resistors in the A/D converter. 1 : Vref ON 0 : Vref OFF
D[14:4]	Reserved	Write 0 when writing. 0 is returned after a read.
D[3]	MSTATE	Indicates MIC operation state (= AIUMEN) 1 : In operation 0 : Stopped
D[2]	Reserved	Write 0 when writing. 0 is returned after a read.
D[1]	MSTOPEN	MIC input DMA transfer 1-page boundary interrupt stop 1 : Stop DMA request at 1-page boundary 0 : Stop DMA request at 2-page boundary
D[0]	ADREQAIU	A/D use request bit 1 : Request 0 : Normal

This register is used to control the AIU's MIC block.

ADENAIU bit controls the connection of AVDD and Vref input to ladder type resistors in the A/D converter. Setting this bit to 0 (OFF) allows low power consumption when not using the A/D converter. When using A/D converter, this bit must be set following the sequence described in 20.3.

The contents of MSTATE bit is valid only when AIUMEN bit of SEQREG is set to 1.

This unit has priority when a conflict occurs with the PIU in relation to A/D requests.

20.2.8 MCNVRREG (0x0B00 0174)

Bit	D15	D14	D13	D12	D11	D10	D9	D8
Name	Reserved	Reserved	Reserved	Reserved	Reserved	Reserved	Reserved	Reserved
R/W	R	R	R	R	R	R	R	R
RTCRST	0	0	0	0	0	0	0	0
Other resets	0	0	0	0	0	0	0	0

Bit	D7	D6	D5	D4	D3	D2	D1	D0
Name	Reserved	Reserved	Reserved	Reserved	Reserved	MCNVR[2]	MCNVR[1]	MCNVR[0]
R/W	R	R	R	R	R	R/W	R/W	R/W
RTCRST	0	0	0	0	0	0	0	0
Other resets	0	0	0	0	0	0	0	0

Bit	Name	Function
D[15:3]	Reserved	Write 0 when writing. 0 is returned after a read.
D[2:0]	MCNVR[2:0]	A/D Conversion Rate 111 : RFU : 101 : RFU 100 : 8 ksps 011 : RFU 010 : 44.1 ksps 001 : 22.05 ksps 000 : 11.025 ksps

This register is used to select a conversion rate for the A/D converter.

20.2.9 DVALIDREG (0x0B00 0178)

Bit	D15	D14	D13	D12	D11	D10	D9	D8
Name	Reserved	Reserved	Reserved	Reserved	Reserved	Reserved	Reserved	Reserved
R/W	R	R	R	R	R	R	R	R
RTCRST	0	0	0	0	0	0	0	0
Other resets	0	0	0	0	0	0	0	0

Bit	D7	D6	D5	D4	D3	D2	D1	D0
Name	Reserved	Reserved	Reserved	Reserved	SODATV	SDMAV	MIDATV	MDMAV
R/W	R	R	R	R	R/W	R/W	R/W	R/W
RTCRST	0	0	0	0	0	0	0	0
Other resets	0	0	0	0	0	0	0	0

Bit	Name	Function
D[15:4]	Reserved	Write 0 when writing. 0 is returned after a read
D[3]	SODATV	This indicates when valid data has been stored in SODATREG. 1 : Valid data exists 0 : No valid data
D[2]	SDMAV	This indicates when valid data has been stored in SDMATATREG. 1 : Valid data exists 0 : No valid data
D[1]	MIDATV	This indicates when valid data has been stored in MIDATREG. 1 : Valid data exists 0 : No valid data
D[0]	MDMAV	This indicates when valid data has been stored in MDMAREG. 1 : Valid data exists 0 : No valid data

This register indicates when valid data has been stored in SODATREG, SDMATATREG, MIDATREG, or MDMAREG.

If data has been written directly to SODATREG, SDMATATREG, MIDATREG, or MDMAREG via software, the bits in this register are not active, so write “1” via software.

Write is used for debugging and is enabled when AIUSEN or AIUMEN bit of SEQREG is set to 1.

If AIUSEN = 0 or AIUMEN = 0 in SEQREG, then SODATV = SDMAV = 0 or MIDATV = MDMAV = 0.

20.2.10 SEQREG (0x0B00 017A)

Bit	D15	D14	D13	D12	D11	D10	D9	D8
Name	AIURST	Reserved	Reserved	Reserved	Reserved	Reserved	Reserved	Reserved
R/W	R/W	R	R	R	R	R	R	R
RTCRST	0	0	0	0	0	0	0	0
Other resets	0	0	0	0	0	0	0	0

Bit	D7	D6	D5	D4	D3	D2	D1	D0
Name	Reserved	Reserved	Reserved	AIUMEN	Reserved	Reserved	Reserved	AIUSEN
R/W	R	R	R	R/W	R	R	R	R/W
RTCRST	0	0	0	0	0	0	0	0
Other resets	0	0	0	0	0	0	0	0

Bit	Name	Function
D[15]	AIURST	AIU reset via software 1 : Reset 0 : Normal
D[14:5]	Reserved	Write 0 when writing. 0 is returned after a read.
D[4]	AIUMEN	MIC block operation enable, DMA enable 1 : Enable operation 0 : Disable operation
D[3:1]	Reserved	Write 0 when writing. 0 is returned after a read.
D[0]	AIUSEN	Speaker block operation enable, DMA enable 1 : Enable operation 0 : Disable operation

This register is used to enable/disable the AIU's operation.

20.2.11 INTREG (0x0B00 017C)

Bit	D15	D14	D13	D12	D11	D10	D9	D8
Name	Reserved	Reserved	Reserved	Reserved	MENDINTR	MINTR	MIDLEINTR	MSTINTR
R/W	R	R	R	R	R/W	R/W	R/W	R/W
RTCRST	0	0	0	0	0	0	0	0
Other resets	0	0	0	0	0	0	0	0

Bit	D7	D6	D5	D4	D3	D2	D1	D0
Name	Reserved	Reserved	Reserved	Reserved	SENDINTR	SINTR	SIDLEINTR	Reserved
R/W	R	R	R	R	R/W	R/W	R/W	R
RTCRST	0	0	0	0	0	0	0	0
Other resets	0	0	0	0	0	0	0	0

Bit	Name	Function
D[15:12]	Reserved	Write 0 when writing. 0 is returned after a read.
D[11]	MENDINTR	MIC DMA 2 page interrupt. Cleared to 0 when 1 is written. 1 : Occurred 0 : Normal
D[10]	MINTR	MIC DMA 1 page interrupt. Cleared to 0 when 1 is written. 1 : Occurred 0 : Normal
D[9]	MIDLEINTR	MIC idle interrupt (receive data loss). Cleared to 0 when 1 is written. 1 : Occurred 0 : Normal
D[8]	MSTINTR	MIC receive complete interrupt. Cleared to 0 when 1 is written. 1 : Occurred 0 : Normal
D[7:4]	Reserved	Write 0 when writing. 0 is returned after a read.
D[3]	SENDINTR	SPEAKER DMA 2 page interrupt. Cleared to 0 when 1 is written. 1 : Occurred 0 : Normal
D[2]	SINTR	SPEAKER DMA 1 page interrupt. Cleared to 0 when 1 is written. 1 : Occurred 0 : Normal
D[1]	SIDLEINTR	SPEAKER idle interrupt (mute). Cleared to 0 when 1 is written. 1 : Occurred 0 : Normal
D[0]	Reserved	Write 0 when writing. 0 is returned after a read.

This register indicates the AIU's interrupt status.

When data is received from the A/D converter, MIDLEINTR is set if valid data still exists in MIDATREG (MIDATV = 1). In this case, MIDATREG is overwritten. MSTINTR is set when data is received in MDMADATREG.

When data is passed to the D/A converter, SIDLEINTR is set if there is no valid data in SODATREG (SODATV = 0). However, this interrupt is valid only after AIUSEN = 1, after which SODATV = 1.

20.3 OPERATION SEQUENCE

20.3.1 Output (Speaker)

1. Set conversion rate (0x0B00 016A: SCNVR = arbitrary)
2. Set output data area to DMAAU
3. DMA enable in DCU
4. Set D/A converter's Vref to ON (0x0B00 0168: DAENAIU = 1)
5. Wait for Vref resistor stabilization time (about 5 μ s) (use the RTC counter)

Even if speaker power is set to ON without waiting for Vref resistor stabilization time and speaker operation is enabled, speaker output starts after the period calculated with the formula below.

$$5 + 1/\text{conversion rate (44.1, 22.05, 11.025, or 8) } (\mu\text{s})$$
6. Set speaker power ON via GPIO.
7. Speaker operation enable (0x0B00 017A: AIUSEN = 1)

DMA request

Receive acknowledge and DMA data from DMA

$$0x0B00\ 0178: \text{SDMAV} = \text{SODATV} = 1$$

Output 10-bit data (0x0B00 0166: SODAT) to D/A converter

$$\text{SODATV} = 0, \text{SDMAV} = 1$$

Send SDMADATREG data to SODATREG

$$\text{SODATV} = 1, \text{SDMAV} = 0$$

Output DMA request and store the second data to SDMADATREG

$$\text{SODATV} = 1, \text{SDMAV} = 1$$

Refresh data at each conversion timing interval (becomes SIDLEINTR = 1 when DMA is slow and SODATV = 0 during conversion timing interval, and (mute) interrupt occurs)

DMA page boundary interrupt occurs at page boundary

Page interrupt is cleared when output continues
8. Speaker operation to disable (0x0B00 017A: AIUSEN = 0)
9. Set speaker power OFF via GPIO.
10. Set D/A converter's Vref to OFF (0x0B00 0168: DAENAIU = 0)
11. DMA disable in DCU

20.3.2 Input (MIC)

1. Set conversion rate (0x0B00 0174: MCNVR = arbitrary)
2. Set input data area in DMAAU
3. DMA enable in DCU
4. Set A/D converter's Vref to ON (0x0B00 0172: ADENAIU = 1)

MIC power can be set ON and MIC operation can be enabled without waiting for Vref resistor stabilization time (about 5 μ s). However, in such a case, sampling starts after the period calculated with the formula below.

$$5 + 1/\text{conversion rate (44.1, 22.05, 11.025, or 8)} (\mu\text{s})$$
5. Set MIC power ON via GPIO.
6. MIC operation enable (0x0B00 017A: AIUMEN = 1)

Output A/D request (ADREQAIU) to A/D converter
Return acknowledge (aiuadack) and 10-bit conversion data from A/D converter
Store data in MIDATREG
0x0B00 0178: MDMAV = 0, MIDATV = 1
Transfer data from MIDATREG to MDMADATREG
MDMAV = 1, MIDATV = 0

The INTMST value becomes "1" and an interrupt (receive complete) occurs
Issue DMA request and store MIDMADATREG data to memory.
MDMAV = 0, MIDATV = 0

An A/D request is issued once per conversion timing interval and 10-bit data is received (becomes MIDDLEINTR = 1 when DMA is slow and MIDATV = 1 during conversion timing interval, and (data loss) interrupt occurs)
DMA page boundary interrupt occurs at page boundary
(Page interrupt is cleared when output continues)
7. MIC operation to disable (0x0B00 017A: AIUMEN = 0)
8. Set MIC power OFF via GPIO
9. Set A/D converter's Vref to OFF (0x0B00 0172: AIUADEN = 0)
10. DMA disable in DCU

CHAPTER 21 KIU (KEYBOARD INTERFACE UNIT)

This chapter describes the KIU's operations and register settings.

21.1 GENERAL

The KIU includes 12 scan lines and 8 detection lines. The number of key inputs to be detected can be selected from 96/80/64, by switching the number of scan lines from 12/10/8.

The register can be set to enable the 12 scan lines to be used as a general-purpose output port.

21.2 REGISTER SET

The KIU registers are listed below.

Table 21-1. KIU Registers

Address	R/W	Register Symbols	Function
0x0B00 0180	R/W	KIUDAT0	KIU Data0 Register
0x0B00 0182	R/W	KIUDAT1	KIU Data1 Register
0x0B00 0184	R/W	KIUDAT2	KIU Data2 Register
0x0B00 0186	R/W	KIUDAT3	KIU Data3 Register
0x0B00 0188	R/W	KIUDAT4	KIU Data4 Register
0x0B00 018A	R/W	KIUDAT5	KIU Data5 Register
0x0B00 0190	R/W	KIUSCANREP	KIU Scan/Repeat Register
0x0B00 0192	R	KIUSCANS	KIU Scan Status Register
0x0B00 0194	R/W	KIUWKS	KIU Wait Keyscan Stable Register
0x0B00 0196	R/W	KIUWKI	KIU Wait Keyscan Interval Register
0x0B00 0198	R/W	KIUINT	KIU Interrupt Register
0x0B00 019A	W	KIURST	KIU Reset Register
0x0B00 019C	R/W	KIUGPEN	KIU General Purpose Output Enable
0x0B00 019E	R/W	SCANLINE	KIU Scan Line Register

21.2.1 KIUDATn (0x0B00 0180 to 0x0B00 018A)

Remark n = 0 to 5

KIUDAT0 (0x0B00 0180)

KIUDAT1 (0x0B00 0182)

KIUDAT2 (0x0B00 0184)

KIUDAT3 (0x0B00 0186)

KIUDAT4 (0x0B00 0188)

KIUDAT5 (0x0B00 018A)

Bit	D15	D14	D13	D12	D11	D10	D9	D8
Name	KEYDAT[15]	KEYDAT[14]	KEYDAT[13]	KEYDAT[12]	KEYDAT[11]	KEYDAT[10]	KEYDAT[9]	KEYDAT[8]
R/W	R/W	R/W	R/W	R/W	R/W	R/W	R/W	R/W
RTCRST	0	0	0	0	0	0	0	0
Other resets	0	0	0	0	0	0	0	0

Bit	D7	D6	D5	D4	D3	D2	D1	D0
Name	KEYDAT[7]	KEYDAT[6]	KEYDAT[5]	KEYDAT[4]	KEYDAT[3]	KEYDAT[2]	KEYDAT[1]	KEYDAT[0]
R/W	R/W	R/W	R/W	R/W	R/W	R/W	R/W	R/W
RTCRST	0	0	0	0	0	0	0	0
Other resets	0	0	0	0	0	0	0	0

Bit	Name	Function
D[15..8]	KEYDAT[15..8]	Scan data from odd-numbered scans
D[7..0]	KEYDAT[7..0]	Scan data from even-numbered scans

These registers are used to hold key scan data.

Each KIU data register is able to hold the data from one scan operation.

How scan data is input to the registers is as below.

Register \ Bit	KEYDAT[15..8]	KEYDAT[7..0]
KIUDAT0	Scan[1]	Scan[0]
KIUDAT1	Scan[3]	Scan[2]
KIUDAT2	Scan[5]	Scan[4]
KIUDAT3	Scan[7]	Scan[6]
KIUDAT4	Scan[9]	Scan[8]
KIUDAT5	Scan[11]	Scan[10]

21.2.2 KIUSCANREP (0x0B00 0190)

Bit	D15	D14	D13	D12	D11	D10	D9	D8
Name	KEYEN	Reserved	Reserved	Reserved	Reserved	Reserved	STPREP[5]	STPREP[4]
R/W	R/W	R	R	R	R	R	R/W	R/W
RTCRST	0	0	0	0	0	0	0	0
Other resets	0	0	0	0	0	0	0	0

Bit	D7	D6	D5	D4	D3	D2	D1	D0
Name	STPREP[3]	STPREP[2]	STPREP[1]	STPREP[0]	SCANSTP	SCANSTART	ATSTP	ATSCAN
R/W	R/W	R/W	R/W	R/W	R/W	R/W	R/W	R/W
RTCRST	0	0	0	0	0	0	0	1
Other resets	0	0	0	0	0	0	0	1

Bit	Name	Function
D[15]	KEYEN	Key scan 1: Enable 0: Prohibit
D[14..10]	Reserved	Write 0 when writing. 0 is returned after a read.
D[9..4]	STPREP[5..0]	Key scan sequencer stop count setting 111111 : 63 times : 000001 : 1 time 000000 : 64 times
D[3]	SCANSTP	Key scan stop 1: Stop 0: Operate
D[2]	SCANSTART	Key scan start 1: Start 0: Stop
D[1]	ATSTP	Key auto stop setting 1: Auto stop 0: Not auto stop
D[0]	ATSCAN	Key auto scan setting 1: Auto scan 0: Not auto scan

This register is used to enable operation of the key scan unit and to make settings for key scan and the key scan sequencer.

- Key scan sequencer stop count setting

This sets the number of key scan sequencer stops when no keys are being pressed.

- Key scan stop
When the SCANSTP bit is set to “1”, the key scan sequencer stops. However, if this bit is set to “1” during a key scan operation, the key scan sequencer stops after the current set of key data is received.
- Key scan start
When the SCANSTART bit is set to “1”, the key scan sequencer starts regardless of key contact detection.
- Key scan auto stop setting
When the ATSTOP bit is set to “1”, the key scan sequencer stops automatically when the data remains all zeros for the number of key scan times specified by STOPREP.
- Key auto scan setting
When the ATSCAN bit is set to “1”, the key scan operation automatically starts after key contact is detected.

21.2.3 KIUSCANS (0x0B00 0192)

Bit	D15	D14	D13	D12	D11	D10	D9	D8
Name	Reserved	Reserved	Reserved	Reserved	Reserved	Reserved	Reserved	Reserved
R/W	R	R	R	R	R	R	R	R
RTCRST	0	0	0	0	0	0	0	0
Other resets	0	0	0	0	0	0	0	0

Bit	D7	D6	D5	D4	D3	D2	D1	D0
Name	Reserved	Reserved	Reserved	Reserved	Reserved	Reserved	SSTAT[1]	SSTAT[0]
R/W	R	R	R	R	R	R	R	R
RTCRST	0	0	0	0	0	0	0	0
Other resets	0	0	0	0	0	0	0	0

Bit	Name	Function
D[15..2]	Reserved	Write 0 when writing. 0 is returned after a read.
D[1..0]	SSTAT[1..0]	KIU sequencer status 11 : Scanning 10 : Interval Next Scan 01 : WaitKeyIn 00 : Stopped

This register indicates the current KIU sequencer status.

Details of the status of the KIU sequencer are described below.

- Scanning: This is the state where the scan sequencer performs key scan to load key data.
- Interval next scan: This is the state where the scan of a set of key data^{Note} has completed and waiting for the start of the next key scan. The interval after the completion of the scan of a set of key data until the start of the next scan is set on the KIUWKIREG.

Note The number of data bits depends on the number of KSCAN pins used as below. The number of KSCAN pins is set in SCANLINE register.

www.DataSheet4U.com

KSCAN pins	Number of data bits
8	64 bits
10	80 bits
12	96 bits

- Wait Key in: This is the state of waiting for key input in the key auto scan mode. When the scan sequencer is enabled while ATSCAN bit of KIUSCANREP register is set to 1, the VR4102 waits for key input in this state. In this case, all outputs of the KSCAN pins^{Note} are in high level. When shifting the CPU to Suspend mode (or Standby mode with TClock masked), be sure to set the KIU to the auto scan mode before the shift and confirm that the sequencer in the Wait key in state.

Note The number of pins is set in LINE[1..0] bits of SCANLINE register as below.

LINE[1..0]	Number of KSCAN pins
10	8
01	10
00	12

- Stopped: This is the state where the sequencer is disabled.

21.2.4 KIUWKS (0x0B00 0194)

Bit	D15	D14	D13	D12	D11	D10	D9	D8
Name	Reserved	T3CNT[4]	T3CNT[3]	T3CNT[2]	T3CNT[1]	T3CNT[0]	T2CNT[4]	T2CNT[3]
R/W	R	R/W	R/W	R/W	R/W	R/W	R/W	R/W
RTCRST	0	1	1	1	1	1	1	1
Other resets	0	1	1	1	1	1	1	1

Bit	D7	D6	D5	D4	D3	D2	D1	D0
Name	T2CNT[2]	T2CNT[1]	T2CNT[0]	T1CNT[4]	T1CNT[3]	T1CNT[2]	T1CNT[1]	T1CNT[0]
R/W	R/W	R/W	R/W	R/W	R/W	R/W	R/W	R/W
RTCRST	1	1	1	1	1	1	1	1
Other resets	1	1	1	1	1	1	1	1

Bit	Name	Function
D[15]	Reserved	Write 0 when writing. 0 is returned after a read.
D[14..10]	T3CNT[4..0]	Wait time setting ((T3CNT[4..0] + 1) * 30 μ s) 11111 : 960 μ s : 00001 : 60 μ s 00000 : RFU
D[9..5]	T2CNT[4..0]	Off time setting ((T2CNT[4..0] + 1) * 30 μ s) 11111 : 960 μ s : 00001 : 60 μ s 00000 : RFU
D[4..0]	T1CNT[4..0]	Stabilization time setting ((T1CNT[4..0] + 1) * 30 μ s) 11111 : 960 μ s : 00001 : 60 μ s 00000 : RFU

This register is used to set the wait time between when the key scan sequencer sets the KSCAN pin “High” during a key matrix scan and when the status is read from the KPORT pin.

The T1CNT bit is used to set the stabilization time between when voltage is applied to the KSCAN pin and when the key scan data is read.

The T2CNT bit is used to set the time between when the key data is read and when voltage applied to the KSCAN pin is set to “OFF”.

The T3CNT bit is used to set the time between when voltage applied to the KSCAN pin is set to “OFF” and when voltage can be again applied to the KSCAN pin.

The status of output from the KSCAN pins and the timing of KPORT sampling are shown below.

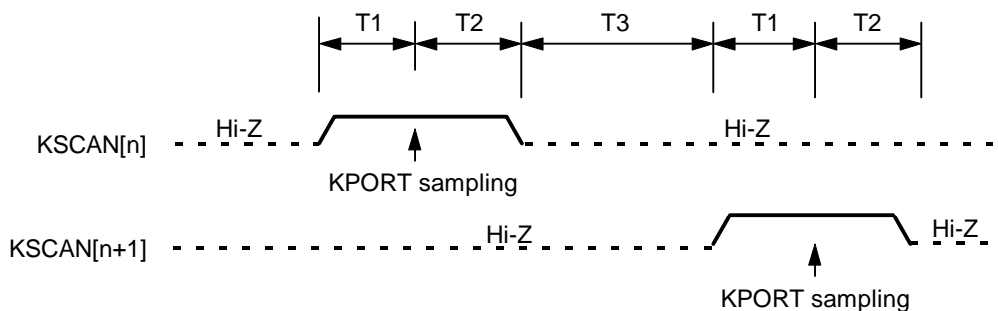

21.2.5 KIUWKI (0x0B00 0196)

Bit	D15	D14	D13	D12	D11	D10	D9	D8
Name	Reserved	Reserved	Reserved	Reserved	Reserved	Reserved	WINTVL[9]	WINTVL[8]
R/W	R	R	R	R	R	R	R/W	R/W
RTCRST	0	0	0	0	0	0	0	0
Other resets	0	0	0	0	0	0	0	0

Bit	D7	D6	D5	D4	D3	D2	D1	D0
Name	WINTVL[7]	WINTVL[6]	WINTVL[5]	WINTVL[4]	WINTVL[3]	WINTVL[2]	WINTVL[1]	WINTVL[0]
R/W	R/W	R/W	R/W	R/W	R/W	R/W	R/W	R/W
RTCRST	0	0	0	0	0	0	0	0
Other resets	0	0	0	0	0	0	0	0

Bit	Name	Function
D[15..10]	Reserved	Write 0 when writing. 0 is returned after a read.
D[9..0]	WINTVL[9..0]	Key scan interval time setting (WINTVL[9..0]*30 μ s) 1111111111 : 30690 μ s : 0000000001 : 30 μ s 0000000000 : No Wait

This register is used to set the interval time between when one set of key data is obtained by the key scan sequencer and when the next set of key data is obtained.

21.2.6 KIUINT (0x0B00 0198)

Bit	D15	D14	D13	D12	D11	D10	D9	D8
Name	Reserved	Reserved	Reserved	Reserved	Reserved	Reserved	Reserved	Reserved
R/W	R	R	R	R	R	R	R	R
RTCRST	0	0	0	0	0	0	0	0
Other resets	0	0	0	0	0	0	0	0

Bit	D7	D6	D5	D4	D3	D2	D1	D0
Name	Reserved	Reserved	Reserved	Reserved	Reserved	KDATLOST	KDATRDY	SCANINT
R/W	R	R	R	R	R	R/W	R/W	R/W
RTCRST	0	0	0	0	0	0	0	0
Other resets	0	0	0	0	0	0	0	0

Bit	Name	Function
D[15..3]	Reserved	Write 0 when writing. 0 is returned after a read.
D[2]	KDATLOST	Key scan data lost interrupt. Cleared to 0 when 1 is written. 1 : Yes 0 : No
D[1]	KDATRDY	Key data scan complete interrupt. Cleared to 0 when 1 is written. 1 : Yes 0 : No
D[0]	SCANINT	Key input detection interrupt. Cleared to 0 when 1 is written. 1 : Yes 0 : No

This register indicates the type of interrupt that has occurred in the KIU.

21.2.7 KIURST (0x0B00 019A)

Bit	D15	D14	D13	D12	D11	D10	D9	D8
Name	Reserved	Reserved	Reserved	Reserved	Reserved	Reserved	Reserved	Reserved
R/W	R	R	R	R	R	R	R	R
RTCRST	0	0	0	0	0	0	0	0
Other resets	0	0	0	0	0	0	0	0

Bit	D7	D6	D5	D4	D3	D2	D1	D0
Name	Reserved	Reserved	Reserved	Reserved	Reserved	Reserved	Reserved	KIURST
R/W	R	R	R	R	R	R	R	W
RTCRST	0	0	0	0	0	0	0	0
Other resets	0	0	0	0	0	0	0	0

Bit	Name	Function
D[15..1]	Reserved	Write 0 when writing. 0 is returned after a read.
D[0]	KIURST	KIU reset. Cleared to 0 when 1 is written. 1 : Reset 0 : Normal operation

This register is used to forcibly reset the KIU.

21.2.8 KIUGPEN (0x0B00 019C)

Bit	D15	D14	D13	D12	D11	D10	D9	D8
Name	Reserved	Reserved	Reserved	Reserved	KGPEN[11]	KGPEN[10]	KGPEN[9]	KGPEN[8]
R/W	R	R	R	R	R/W	R/W	R/W	R/W
RTCRST	0	0	0	0	0	0	0	0
Other resets	0	0	0	0	0	0	0	0

Bit	D7	D6	D5	D4	D3	D2	D1	D0
Name	KGPEN[7]	KGPEN[6]	KGPEN[5]	KGPEN[4]	KGPEN[3]	KGPEN[2]	KGPEN[1]	KGPEN[0]
R/W	R/W	R/W	R/W	R/W	R/W	R/W	R/W	R/W
RTCRST	0	0	0	0	0	0	0	0
Other resets	0	0	0	0	0	0	0	0

Bit	Name	Function
D[15..12]	Reserved	Write 0 when writing. 0 is returned after a read.
D[11..0]	KGPEN[11..0]	SCAN pin function 1 : Use as output port 0 : Use as SCAN pin

This register is used to set whether or not the KSCAN pins will function as a general-purpose output port. Setting a “1” to each bit in this register enables the KSCAN pin to function as a general-purpose output port. The output port setting are made via the GIU’s GIUPODATL register (0x0B00 011C).

21.2.9 SCANLINE (0x0B00 019E)

Bit	D15	D14	D13	D12	D11	D10	D9	D8
Name	Reserved	Reserved	Reserved	Reserved	Reserved	Reserved	Reserved	Reserved
R/W	R	R	R	R	R	R	R	R
RTCRST	0	0	0	0	0	0	0	0
Other resets	0	0	0	0	0	0	0	0

Bit	D7	D6	D5	D4	D3	D2	D1	D0
Name	Reserved	Reserved	Reserved	Reserved	Reserved	Reserved	LINE[1]	LINE[0]
R/W	R	R	R	R	R	R	R/W	R/W
RTCRST	0	0	0	0	0	0	0	0
Other resets	0	0	0	0	0	0	0	0

Bit	Name	Function
D[15..2]	Reserved	Write 0 when writing. 0 is returned after a read.
D[1..0]	LINE[1..0]	<p>SCAN pin use/do not use setting</p> <p>11 : Do not use SCAN pins for key scan The KIU's SCAN pins can be used as an output port.</p> <p>10 : Use eight key scan pins (KSCAN[7..0]) Key scan uses eight key scan pins (supports 64 keys) The remaining four pins can be used as an output port.</p> <p>01 : Use ten key scan pins (KSCAN[9..0]) Key scan uses ten key scan pins (supports 80 keys) The remaining two pins can be used as an output port.</p> <p>00 : Use twelve key scan pins (KSCAN[11..0]) Key scan uses twelve key scan pins (supports 96 keys) No pins can be used as an output port.</p>

This register is used to switch the number of scan lines.

CHAPTER 22 DSIU (DEBUG SERIAL INTERFACE UNIT)

This chapter describes the DSIU's operations and register settings.

22.1 GENERAL

The DSIU (debug serial interface unit) supports transfer rates up to 115.2 kbps. In addition to the DDIN and DDOUT input/output pins, the DSIU supports the DCTS# and DRTS# pins that are used for hardware flow control.

22.2 REGISTER SET

The DSIU registers are listed below.

Table 22-1. DSIU Registers

Address	R/W	Register Symbols	Function
0x0B00 01A0	R/W	PORTREG	Port Change Register
0x0B00 01A2	R	MODEMREG	Modem Control Register
0x0B00 01A4	R/W	ASIM00REG	Asynchronous Mode 0 Register
0x0B00 01A6	R/W	ASIM01REG	Asynchronous Mode 1 Register
0x0B00 01A8	R	RXB0RREG	Receive Buffer Register (Extended)
0x0B00 01AA	R	RXB0LREG	Receive Buffer Register
0x0B00 01AC	R/W	TXS0RREG	Transmit Data Register (Extended)
0x0B00 01AE	R/W	TXS0LREG	Transmit Data Register
0x0B00 01B0	R	ASIS0REG	Status Register
0x0B00 01B2	R/W	INTR0REG	Debug SIU Interrupt Register
0x0B00 01B6	R/W	BPRM0REG	Baud rate Generator Prescaler Mode Register
0x0B00 01B8	R/W	DSIURESETREG	Debug SIU Reset Register

These registers are described in detail below.

22.2.1 PORTREG (0x0B00 01A0)

Bit	D15	D14	D13	D12	D11	D10	D9	D8
Name	Reserved	Reserved	Reserved	Reserved	Reserved	Reserved	Reserved	Reserved
R/W	R	R	R	R	R	R	R	R
RTCRST	0	0	0	0	0	0	0	0
Other resets	0	0	0	0	0	0	0	0

Bit	D7	D6	D5	D4	D3	D2	D1	D0
Name	Reserved	Reserved	Reserved	Reserved	CDDIN	CDDOUT	CDRTS	CDCTS
R/W	R	R	R	R	R/W	R/W	R/W	R/W
RTCRST	0	0	0	0	0	0	0	0
Other resets	0	0	0	0	0	0	0	0

Bit	Name	Function
D[15:4]	Reserved	Write 0 when writing. 0 is returned after a read.
D[3]	CDDIN	This pin is used to switch the DDIN pin for use as a general-purpose output pin. 1 : General-purpose output 0 : DDIN
D[2]	CDDOUT	This pin is used to switch the DDOUT pin for use as a general-purpose output pin. 1 : General-purpose output 0 : DDOUT
D[1]	CDRTS	This pin is used to switch the DRTS# pin for use as a general-purpose output pin. 1 : General-purpose output 0 : DRTS#
D[0]	CDCTS	This pin is used to switch the DCTS# pin for use as a general-purpose output pin. 1 : General-purpose output 0 : DCTS#

This register is used to switch the DSU pin for use as a general-purpose output pin.

Note that the output value should be set in the GIU when the DSU pins are set to general-purpose outputs.

22.2.2 MODEMREG (0x0B00 01A2)

Bit	D15	D14	D13	D12	D11	D10	D9	D8
Name	Reserved	Reserved	Reserved	Reserved	Reserved	Reserved	Reserved	Reserved
R/W	R	R	R	R	R	R	R	R
RTCRST	0	0	0	0	0	0	0	0
Other resets	0	0	0	0	0	0	0	0

Bit	D7	D6	D5	D4	D3	D2	D1	D0
Name	Reserved	Reserved	Reserved	Reserved	Reserved	Reserved	DRTS	DCTS
R/W	R	R	R	R	R	R	R	R
RTCRST	0	0	0	0	0	0	1	1
Other resets	0	0	0	0	0	0	1	1

Bit	Name	Function
D[15:2]	Reserved	Write 0 when writing. 0 is returned after a read.
D[1]	DRTS	DRTS# pin output 1: High level 0: Low level
D[0]	DCTS	DCTS# pin input 1: High level 0: Low level

This register is used for flow control and can be used to pass signals between the Vr4102 and external agents. Note that the setting of RXE0 bit of ASIM00REG is reflected on the output from DRTS# pin.

22.2.3 ASIM00REG (0x0B00 01A4)

Bit	D15	D14	D13	D12	D11	D10	D9	D8
Name	Reserved	Reserved	Reserved	Reserved	Reserved	Reserved	Reserved	Reserved
R/W	R	R	R	R	R	R	R	R
RTCRST	0	0	0	0	0	0	0	0
Other resets	0	0	0	0	0	0	0	0

Bit	D7	D6	D5	D4	D3	D2	D1	D0
Name	Reserved	RXE0	PS0[1]	PS0[0]	CL0	SL0	Reserved	Reserved
R/W	R	R/W	R/W	R/W	R/W	R/W	R	R
RTCRST	1	0	0	0	0	0	0	0
Other resets	1	0	0	0	0	0	0	0

Bit	Name	Function
D[15:8]	Reserved	Write 0 when writing. 0 is returned after a read.
D[7]	Reserved	Write 1 when writing. 1 is returned after a read.
D[6]	RXE0	Debug serial reception enable 1 : Enable 0 : Prohibit
D[5:4]	PS0[1:0]	Debug serial parity select 11 : Even parity 10 : Odd parity 01 : Zero parity bits during transmit No parity during receive 00 : No parity. Set to 00 for extended-bit operations
D[3]	CL0	Debug serial character length setting 1 : 8 bits 0 : 7 bits
D[2]	SL0	Debug serial stop bit setting 1 : 2 bits 0 : 1 bit
D[1:0]	Reserved	Write 0 when writing. 0 is returned after a read.

This register is used to make various serial communication settings for debugging.

The setting of RXE0 bit is reflected on the output from DRTS# pin. 0 is output when this bit is set to 1 (reception enable), and 1 is output when this bit is set to 0 (reception prohibit).

If this register is changed during transmission or reception of serial data for debugging, the DSU's operations cannot be guaranteed.

22.2.4 ASIM01REG (0x0B00 01A6)

Bit	D15	D14	D13	D12	D11	D10	D9	D8
Name	Reserved	Reserved	Reserved	Reserved	Reserved	Reserved	Reserved	Reserved
R/W	R	R	R	R	R	R	R	R
RTCRST	0	0	0	0	0	0	0	0
Other resets	0	0	0	0	0	0	0	0

Bit	D7	D6	D5	D4	D3	D2	D1	D0
Name	Reserved	Reserved	Reserved	Reserved	Reserved	Reserved	Reserved	EBS0
R/W	R	R	R	R	R	R	R	R/W
RTCRST	0	0	0	0	0	0	0	0
Other resets	0	0	0	0	0	0	0	0

Bit	Name	Function
D[15:1]	Reserved	Write 0 when writing. 0 is returned after a read.
D[0]	EBS0	Extended bit operation enable 1 : Enable 0 : Prohibit

This register is used to set extended bit operations for the DSU.

When "1" is set to the EBS0 bit, one bit is added to the 8-bit data length for transmission and reception to enable operations using 9-bit data. Extended-bit operations are valid only when "00" has been set to ASIM00REG's PS0[1:0] bit. If a value other than "00" has been set to ASIM00REG's PS0[1:0] bit, the EBS0 bit specification is ignored and extended-bit operations cannot be performed.

22.2.5 RXB0RREG (0x0B00 01A8)

Bit	D15	D14	D13	D12	D11	D10	D9	D8
Name	Reserved	Reserved	Reserved	Reserved	Reserved	Reserved	Reserved	RXB0[8]
R/W	R	R	R	R	R	R	R	R
RTCRST	0	0	0	0	0	0	0	0
Other resets	0	0	0	0	0	0	0	0

Bit	D7	D6	D5	D4	D3	D2	D1	D0
Name	RXB0[7]	RXB0[6]	RXB0[5]	RXB0[4]	RXB0[3]	RXB0[2]	RXB0[1]	RXB0[0]
R/W	R	R	R	R	R	R	R	R
RTCRST	0	0	0	0	0	0	0	0
Other resets	0	0	0	0	0	0	0	0

Bit	Name	Function
D[15:9]	Reserved	Write 0 when writing. 0 is returned after a read.
D[8:0]	RXB0[8:0]	Receive data [8:0]

This register is used to store debug serial receive data.

The RXB0[8] bit stores the extended bit during extended-bit operations and stores a zero during 7- or 8-bit character reception. The RXB0[7] bit stores a zero during 7-bit character reception.

22.2.6 RXB0LREG (0x0B00 01AA)

Bit	D15	D14	D13	D12	D11	D10	D9	D8
Name	Reserved	Reserved	Reserved	Reserved	Reserved	Reserved	Reserved	Reserved
R/W	R	R	R	R	R	R	R	R
RTCRST	0	0	0	0	0	0	0	0
Other resets	0	0	0	0	0	0	0	0

Bit	D7	D6	D5	D4	D3	D2	D1	D0
Name	RXB0L[7]	RXB0L[6]	RXB0L[5]	RXB0L[4]	RXB0L[3]	RXB0L[2]	RXB0L[1]	RXB0L[0]
R/W	R	R	R	R	R	R	R	R
RTCRST	0	0	0	0	0	0	0	0
Other resets	0	0	0	0	0	0	0	0

Bit	Name	Function
D[15:8]	Reserved	Write 0 when writing. 0 is returned after a read.
D[7:0]	RXB0L[7:0]	Receive data [7:0]

This register is used to store debug serial receive data.

The RXB0L[7] bit stores a zero during 7-bit character reception.

The only difference between this register and RXBORREG is that this register does not support extended-bit operations.

22.2.7 TXS0RREG (0x0B00 01AC)

Bit	D15	D14	D13	D12	D11	D10	D9	D8
Name	Reserved	Reserved	Reserved	Reserved	Reserved	Reserved	Reserved	TXS0[8]
R/W	R	R	R	R	R	R	R	R/W
RTCRST	0	0	0	0	0	0	0	1
Other resets	0	0	0	0	0	0	0	1

Bit	D7	D6	D5	D4	D3	D2	D1	D0
Name	TXS0[7]	TXS0[6]	TXS0[5]	TXS0[4]	TXS0[3]	TXS0[2]	TXS0[1]	TXS0[0]
R/W	R/W	R/W	R/W	R/W	R/W	R/W	R/W	R/W
RTCRST	1	1	1	1	1	1	1	1
Other resets	1	1	1	1	1	1	1	1

Bit	Name	Function
D[15:9]	Reserved	Write 0 when writing. 0 is returned after a read.
D[8:0]	TXS0[8:0]	Transmit data [8:0]

This register is used to store debug serial transmit data.

The TXS0[8] bit is used to transmit the extended bit during extended-bit operations.

22.2.8 TXS0LREG (0x0B00 01AE)

Bit	D15	D14	D13	D12	D11	D10	D9	D8
Name	Reserved	Reserved	Reserved	Reserved	Reserved	Reserved	Reserved	Reserved
R/W	R	R	R	R	R	R	R	R
RTCRST	0	0	0	0	0	0	0	0
Other resets	0	0	0	0	0	0	0	0

Bit	D7	D6	D5	D4	D3	D2	D1	D0
Name	TXS0L[7]	TXS0L[6]	TXS0L[5]	TXS0L[4]	TXS0L[3]	TXS0L[2]	TXS0L[1]	TXS0L[0]
R/W	R/W	R/W	R/W	R/W	R/W	R/W	R/W	R/W
RTCRST	1	1	1	1	1	1	1	1
Other resets	1	1	1	1	1	1	1	1

Bit	Name	Function
D[15:8]	Reserved	Write 0 when writing. 0 is returned after a read.
D[7:0]	TXS0L[7:0]	Transmit data [7:0]

This register is used to store debug serial transmit data.

The only difference between this register and TXS0RREG is that this register does not support extended-bit operations.

22.2.9 ASIS0REG (0x0B00 01B0)

Bit	D15	D14	D13	D12	D11	D10	D9	D8
Name	Reserved	Reserved	Reserved	Reserved	Reserved	Reserved	Reserved	Reserved
R/W	R	R	R	R	R	R	R	R
RTCRST	0	0	0	0	0	0	0	0
Other resets	0	0	0	0	0	0	0	0

Bit	D7	D6	D5	D4	D3	D2	D1	D0
Name	SOT0	Reserved	Reserved	Reserved	Reserved	PE0	FE0	OVE0
R/W	R	R	R	R	R	R	R	R
RTCRST	0	0	0	0	0	0	0	0
Other resets	0	0	0	0	0	0	0	0

Bit	Name	Function
D[15:8]	Reserved	Write 0 when writing. 0 is returned after a read.
D[7]	SOT0	Transmit mode status 1 : Transmission start 0 : Transmission complete
D[6:3]	Reserved	Write 0 when writing. 0 is returned after a read.
D[2]	PE0	Parity error status 1 : Parity error 0 : Normal
D[1]	FE0	Framing error status 1 : Framing error 0 : Normal
D[0]	OVE0	Overrun error status 1 : Overrun error status 0 : Normal

This register indicates the debug serial transmit/receive status.

A write to the TXS0RREG or TXS0LREG register sets “1” to the SOT0 bit. When the transmission is completed, “1” is set to the INTR0REG register’s INTST0 bit and the SOT0 bit is cleared to zero. This bit can be used as a means of determining whether or not it is possible to write to the transmission shift register when transmitting data in debug serial mode.

If the received data contains a parity error, “1” is set to the PE0 bit. If the stop bit is not detected, “1” is set to the FE0 bit.

An overrun error occurs and “1” is set to the OVE0 bit if the sequencer completes the next receive processing before receive data is read from the receive buffer. When an overrun error occurs, the old data in the receive buffer is overwritten by the newly received data.

22.2.10 INTR0REG (0x0B00 01B2)

Bit	D15	D14	D13	D12	D11	D10	D9	D8
Name	Reserved	Reserved	Reserved	Reserved	Reserved	Reserved	Reserved	Reserved
R/W	R	R	R	R	R	R	R	R
RTCRST	0	0	0	0	0	0	0	0
Other resets	0	0	0	0	0	0	0	0

Bit	D7	D6	D5	D4	D3	D2	D1	D0
Name	Reserved	Reserved	Reserved	Reserved	INTDCD	INTSER0	INTSR0	INTST0
R/W	R	R	R	R	R/W	R/W	R/W	R/W
RTCRST	0	0	0	0	0	0	0	0
Other resets	0	0	0	0	0	0	0	0

Bit	Name	Function
D[15:4]	Reserved	Write 0 when writing. 0 is returned after a read.
D[3]	INTDCD	CTS# change interrupt. Cleared to 0 when 1 is written. 1 : CTS change interrupt 0 : Normal
D[2]	INTSER0	Debug serial receive error interrupt. Cleared to 0 when 1 is written. 1 : Error interrupt 0 : Normal
D[1]	INTSR0	Debug serial receive complete interrupt. Cleared to 0 when 1 is written. 1 : Receive complete 0 : Other
D[0]	INTST0	Debug serial transmit complete interrupt. Cleared to 0 when 1 is written. 1 : Transmit complete 0 : Other

This register indicates interrupt events that occur during debug serial transmission.

When debug serial operations are in the reception-enable mode, and either the PE0 bit, FE0 bit, or OVE0 bit in the ASIS0REG has been set, "1" is set to the INTSER0 bit.

When debug serial operations are in the reception-enable mode, and receive data is transferred to the receive buffer, "1" is set to the INTSR0 bit. When one frame of transmit data is sent from the transmit register, "1" is set to the INTST0 bit.

When the CTS# (flow control signal from an external agent) is changed, "1" is set to INTDCD bit.

22.2.11 BPRM0REG (0x0B00 01B6)

Bit	D15	D14	D13	D12	D11	D10	D9	D8
Name	Reserved	Reserved	Reserved	Reserved	Reserved	Reserved	Reserved	Reserved
R/W	R	R	R	R	R	R	R	R
RTCRST	0	0	0	0	0	0	0	0
Other resets	0	0	0	0	0	0	0	0

Bit	D7	D6	D5	D4	D3	D2	D1	D0
Name	BRCE0	Reserved	Reserved	Reserved	Reserved	BPR0[2]	BPR0[1]	BPR0[0]
R/W	R/W	R/W	R/W	R/W	R/W	R/W	R/W	R/W
RTCRST	0	0	0	0	0	0	0	0
Other resets	0	0	0	0	0	0	0	0

Bit	Name	Function
D[15:8]	Reserved	Write 0 when writing. 0 is returned after a read.
D[7]	BRCE0	Baud rate generator count enable 1 : Enable 0 : Prohibit
D[6:3]	Reserved	Write 0 when writing. 0 is returned after a read.
D[2:0]	BPR0[2:0]	Debug serial baud rate setting 111 : 115200 bps 110 : 57600 bps 101 : 38400 bps 100 : 19200 bps 011 : 9600 bps 010 : 4800 bps 001 : 2400 bps 000 : 1200 bps

This register is used to set the baud rate for debug serial communications.

Debug serial operations are not guaranteed if the baud rate is changed during transmission or reception.

22.2.12 DSURESETREG (0x0B00 01B8)

Bit	D15	D14	D13	D12	D11	D10	D9	D8
Name	Reserved	Reserved	Reserved	Reserved	Reserved	Reserved	Reserved	Reserved
R/W	R	R	R	R	R	R	R	R
RTCRST	0	0	0	0	0	0	0	0
Other resets	0	0	0	0	0	0	0	0

Bit	D7	D6	D5	D4	D3	D2	D1	D0
Name	Reserved	Reserved	Reserved	Reserved	Reserved	Reserved	Reserved	DSIURST
R/W	R	R	R	R	R	R	R	R/W
RTCRST	0	0	0	0	0	0	0	0
Other resets	0	0	0	0	0	0	0	0

Bit	Name	Function
D[15:1]	Reserved	Write 0 when writing. 0 is returned after a read
D[0]	DSIURST	Debug serial reset. Cleared to 0 when 1 is written. 1 : Reset 0 : Normal

This register is used to reset the debug serial mode.

22.3 DESCRIPTION OF OPERATIONS

22.3.1 Data Format

Serial data is transmitted and received in full-duplex mode.

The format of the transmit and receive data is shown in the following figure. Each frame includes a start bit, character bits, parity bit, and stop bit(s). Specification of the character bit length in one data frame, along with the parity setting, and stop bit length specification are all made via the mode registers (ASIM00REG and ASIM01REG).

Figure 22-1. Data Format for Transmission and Reception

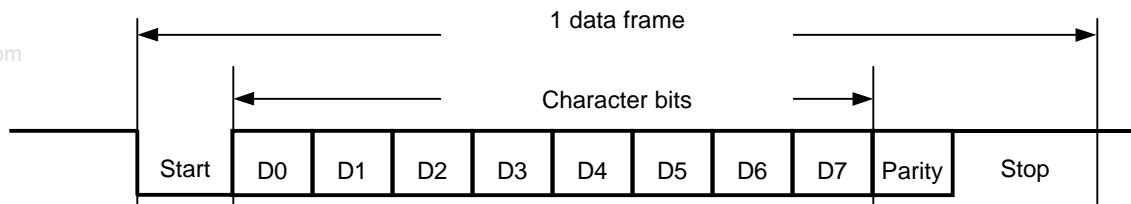

- Start bit : 1 bit
- Character bits (Dn) : 7, 8, or 9 bits (when using extended bit) (n = 0 to 8)
- Parity bit : Even parity, odd parity, zero parity, or no parity
- Stop bit(s) : 1 bit or 2 bits

22.3.2 Transmission

After the DCTS# pin value is confirmed as “1”, writing data to a transmission shift register (TXS0REG or TXS0LREG) activates transmission via the DDOUT pin. Use the transmit complete interrupt (Dsiu_Intst0) service routine to write the next data to TXS0REG or TXS0LREG.

Transmission enable status

The DSIU unit is always set to transmission enable status. The DCTS# pin is used when it is necessary to confirm that the remote side is ready to receive.

Activation of transmit operation

Writing data to a transmission shift register (TXS0REG or TXS0LREG) activates the transmit operation. The transmit data is sent in LSB-first order, beginning with the start bit. The start bit, parity bit, and stop bit(s) are added automatically.

Transmit complete interrupt request

Once one frame of data has been sent, a transmit complete interrupt request (Dsiu_Intst0) occurs. If the next data to be transmitted is then not written to TXS0REG or TXS0LREG, the transmit operation is halted and the transmission rate is lowered.

- Cautions**
1. Normally, the transmit complete interrupt request (Dsiu_Intst0) occurs when the TXS0REG or TXS0LREG register is empty. However, if a reset is input, the transmit complete interrupt request (Dsiu_Intst0) will not occur even when the transmission shift register (TXS0REG or TXS0LREG) is empty.
 2. Writing to either TXS0REG or TXS0LREG is prohibited during a transmit operation until Dsiu_Intst0 occurs.

Figure 22-2. Transmit Complete Interrupt Timing



22.3.3 Reception

Once reception enable has been set, sampling of the DDIN pin begins and, when a start bit is detected, data reception begins. A receive complete interrupt (Dsiu_Intst0) occurs each time reception of one frame of data is completed. Normally, this interrupt service is used to transfer receive data from a receive buffer (RXB0REG or RXB0LREG) to memory.

Reception enable status

Setting the ASIM00REG's bit[6] sets enable status for the receive operation, and a zero is output to DRTS#.

RXE0 = 1: Reception enable status	DRTS# = 0
RXE0 = 0: Reception prohibit status	DRTS# = 1

www.DataSheet4U.com

The reception hardware is initialized and enters idle mode when reception prohibit status has been set. Once that happens, receive complete interrupts and receive error interrupts are not issued and the contents of the receive buffer are retained.

Activation of receive operation

The receive operation is activated when a start bit is detected.

The DDIN pin is sampled at the interval set by the serial clock specified via the ASIM00REG. Once a signal's falling edge is detected at the DDIN pin, the DDIN pin is again sampled after an interval of eight serial clocks. This time, when a low-level state is detected it is recognized as a start bit and control is passed to the receive operation, after which the DDIN pin continues to be sampled using an interval of 16 serial clocks.

After eight serial clocks have elapsed since a signal's falling edge was detected at the DDIN pin, when sampling recognizes a high-level state it does not recognize the signal's falling edge as a start bit. Instead, the serial clock counter used for the sampling timing is initialized and the receive operation is halted until the next edge input.

Receive complete interrupt request

When RXE0 = 1 and one frame of data has been received, the receive data in the shift register is transferred to RXB0REG and a receive complete interrupt request (Dsiu_Intsr0) is issued. Even when an error has occurred, the receive data for which the error occurred is still transferred to a receive buffer (RXB0REG or RXB0LREG) and two interrupts; a receive complete interrupt (Dsiu_Intsr0) and a receive error interrupt (Dsiu_Intser0), occur at the same time.

If the RXE0 bit is reset (to "0") during a receive operation, the receive operation is halted immediately. At that point, the contents of the receive buffer (RXB0REG or RXB0LREG) and ASIS0REG are not changed and neither the receive complete interrupt (Dsiu_Intsr0) nor the receive error interrupt (Dsiu_Intser0) occur.

Figure 22-3. Receive Complete Interrupt Timing

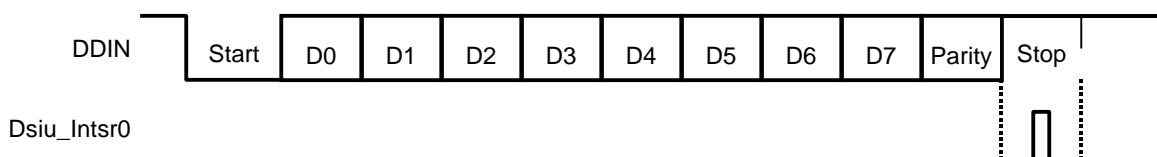

Receive error flag

Receive operations can be affected by three types of error flags that are set during the receive operations: a parity error flag, a framing error flag, and an overrun error flag.

A receive error interrupt request is issued after these three types of error flags are ORed.

During a receive error interrupt (Dsiu_Intsr0), the contents of the ASIS0REG can be read to detect which kind of error occurred during reception.

The contents of the ASIS0REG are reset (to “0”) when the receive buffer (RXB0REG or RXB0LREG) is read or when the next data is received (another error flag is set if the next data also contains an error).

Table 22-2. Receive Error Causes

Receive error	Cause
Parity error	Parity specified during reception does not match parity of receive data
Framing error	Stop bit is not detected
Overrun error	Reception of the next data is completed before data is read from the receive buffer

Figure 22-4. Receive Error Timing

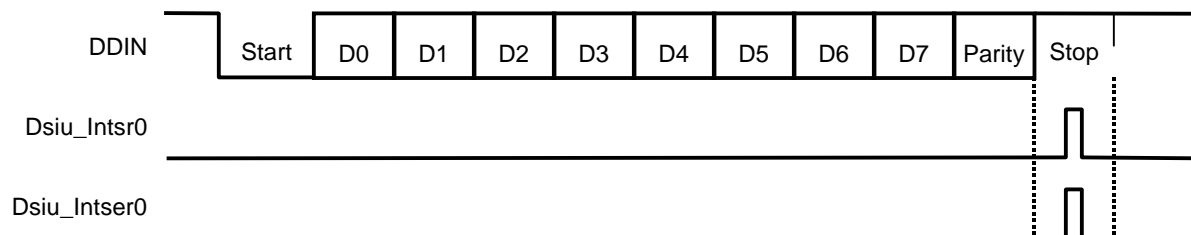

CHAPTER 23 LED (LED CONTROL UNIT)

This chapter describes LED operations and register settings.

23.1 GENERAL

An LED is switched on and off at a regular interval. The interval can be set as programmable. This unit can operate during Standby, Suspend, or Hibernate mode.

23.2 REGISTER SET

The LED registers are listed below.

Table 23-1. LED Registers

Address	R/W	Register Symbols	Function
0x0B00 0240	R/W	LEDHTSREG	LED H Time Set register
0x0B00 0242	R/W	LEDLTSREG	LED L Time Set register
0x0B00 0248	R/W	LEDCNTREG	LED Control register
0x0B00 024A	R/W	LEDASTCREG	LED Auto Stop Time Count register
0x0B00 024C	R/W	LEDINTREG	LED Interrupt register

These registers are described in detail below.

23.2.1 LEDHTSREG (0x0B00 0240)

Bit	D15	D14	D13	D12	D11	D10	D9	D8
Name	Reserved	Reserved	Reserved	Reserved	Reserved	Reserved	Reserved	Reserved
R/W	R	R	R	R	R	R	R	R
RTCRST	0	0	0	0	0	0	0	0
Other resets	0	0	0	0	0	0	0	0

Bit	D7	D6	D5	D4	D3	D2	D1	D0
Name	Reserved	Reserved	Reserved	HTS[4]	HTS[3]	HTS[2]	HTS[1]	HTS[0]
R/W	R	R	R	R/W	R/W	R/W	R/W	R/W
RTCRST	0	0	0	1	0	0	0	0
Other resets	0	0	0	Note	Note	Note	Note	Note

Bit	Name	Function
D[15..5]	Reserved	Write 0 when writing. 0 is returned after a read.
D[4..0]	HTS[4..0]	LED ON time 00000 : Prohibit 00001 : 0.0625 seconds 00010 : 0.125 seconds : 00100 : 0.25 seconds : 01000 : 0.5 seconds : 10000 : 1 second : 11111 : 1.9375 seconds

Note Previous value is retained

This register is used to set the LED's ON time (high-level width of LEDOUT#).

The ON time ranges from 0.0625 to 1.9375 seconds and can be set in 0.0625-second units. The initial value is 1 second.

This register cannot be changed once the LEDENABLE bit of LEDCNTREG has been set as "enable". Operation is not guaranteed if a change is made after that point.

23.2.2 LEDLTSREG (0x0B00 0242)

Bit	D15	D14	D13	D12	D11	D10	D9	D8
Name	Reserved	Reserved	Reserved	Reserved	Reserved	Reserved	Reserved	Reserved
R/W	R	R	R	R	R	R	R	R
RTCST	0	0	0	0	0	0	0	0
Other resets	0	0	0	0	0	0	0	0

Bit	D7	D6	D5	D4	D3	D2	D1	D0
Name	Reserved	LTS[6]	LTS[5]	LTS[4]	LTS[3]	LTS[2]	LTS[1]	LTS[0]
R/W	R	R/W	R/W	R/W	R/W	R/W	R/W	R/W
RTCST	0	0	1	0	0	0	0	0
Other resets	0	Note	Note	Note	Note	Note	Note	Note

Bit	Name	Function
D[15..7]	Reserved	Write 0 when writing. 0 is returned after a read.
D[6..0]	LTS[6..0]	LED OFF time 0000000 : Prohibit 0000001 : 0.0625 seconds 0000010 : 0.125 seconds : 0000100 : 0.25 seconds : 0001000 : 0.5 seconds : 0010000 : 1 second : 0100000 : 2 seconds : 1000000 : 4 seconds : 1111111 : 7.9375 seconds

Note Previous value is retained

This register is used to set the LED's OFF time (low-level width of LEDOUT#).

The OFF time ranges from 0.0625 to 7.9375 seconds and can be set in 0.0625-second units. The initial value is 2 seconds.

This register cannot be changed once the LEDENABLE bit of LEDCNTREG has been set as "enable". Operation is not guaranteed if a change is made after that point.

23.2.3 LEDCNTREG (0x0B00 0248)

Bit	D15	D14	D13	D12	D11	D10	D9	D8
Name	Reserved	Reserved	Reserved	Reserved	Reserved	Reserved	Reserved	Reserved
R/W	R	R	R	R	R	R	R	R
RTCRST	0	0	0	0	0	0	0	0
Other resets	0	0	0	0	0	0	0	0

Bit	D7	D6	D5	D4	D3	D2	D1	D0
Name	Reserved	Reserved	Reserved	Reserved	Reserved	Reserved	LEDSTOP	LEDENABLE
R/W	R	R	R	R	R	R	R/W	R/W
RTCRST	0	0	0	0	0	0	1	0
Other resets	0	0	0	0	0	0	Note	Note

Bit	Name	Function
D[15..2]	Reserved	Write 0 when writing. 0 is returned after a read.
D[1]	LEDSTOP	LED ON/OFF auto stop setting 1 : ON 0 : OFF
D[0]	LEDENABLE	LED ON/OFF (blink) setting 1 : Blink 0 : Do not blink

Note Previous value is retained

This register is used to make various LED settings.

Caution When setting up LED activation, make sure that a value other than zero has already been set to the LEDHTSREG, LEDLTSREG, and LEDASTCREG. The operation is not guaranteed if zero is set to these registers.

23.2.4 LEDASTCREG (0x0B00 024A)

Bit	D15	D14	D13	D12	D11	D10	D9	D8
Name	ASTC[15]	ASTC[14]	ASTC[13]	ASTC[12]	ASTC[11]	ASTC[10]	ASTC[9]	ASTC[8]
R/W	R/W	R/W	R/W	R/W	R/W	R/W	R/W	R/W
RTCRST	0	0	0	0	0	1	0	0
Other resets	0	0	0	0	0	1	0	0

Bit	D7	D6	D5	D4	D3	D2	D1	D0
Name	ASTC[7]	ASTC[6]	ASTC[5]	ASTC[4]	ASTC[3]	ASTC[2]	ASTC[1]	ASTC[0]
R/W	R/W	R/W	R/W	R/W	R/W	R/W	R/W	R/W
RTCRST	1	0	1	1	0	0	0	0
Other resets	1	0	1	1	0	0	0	0

Bit	Name	Function
D[15..0]	ASTC[15..0]	LED auto stop time count bit

This register is a 16-bit down counter that sets the number of ON/OFF times prior to automatic stopping of LED activation. The set value is read during a read.

The pair of operations in which the LED is switched ON once and OFF once is counted as "1" by this counter. The counter counts down from the set value and an LEDINT interrupt occurs when it reaches zero.

The initial setting is 1,200 times (ON/OFF pairs) in which each time includes one second of ON time and two seconds of OFF time.

Caution Setting a zero to this register is prohibited. The operation is not guaranteed if zero is set to this register.

23.2.5 LEDINTREG (0x0B00 024C)

Bit	D15	D14	D13	D12	D11	D10	D9	D8
Name	Reserved	Reserved	Reserved	Reserved	Reserved	Reserved	Reserved	Reserved
R/W	R	R	R	R	R	R	R	R
RTCRST	0	0	0	0	0	0	0	0
Other resets	0	0	0	0	0	0	0	0

Bit	D7	D6	D5	D4	D3	D2	D1	D0
Name	Reserved	Reserved	Reserved	Reserved	Reserved	Reserved	Reserved	LEDINT
R/W	R	R	R	R	R	R	R	R/W
RTCRST	0	0	0	0	0	0	0	0
Other resets	0	0	0	0	0	0	0	0

Bit	Name	Function
D[15..1]	Reserved	Write 0 when writing. 0 is returned after a read.
D[0]	LEDINT	Auto stop interrupt. Cleared to 0 when 1 is written. 1 : Yes 0 : No

This register indicates when an auto stop interrupt has occurred.

An auto stop interrupt occurs if “1” has already been set to bit 1 and bit 0 of the LEDCNTREG when the LEDASTCREG is cleared to “0”. When this interrupt occurs, bit 1 and bit 0 of the LEDCNTREG are both cleared to “0”.

23.3 OPERATION FLOW

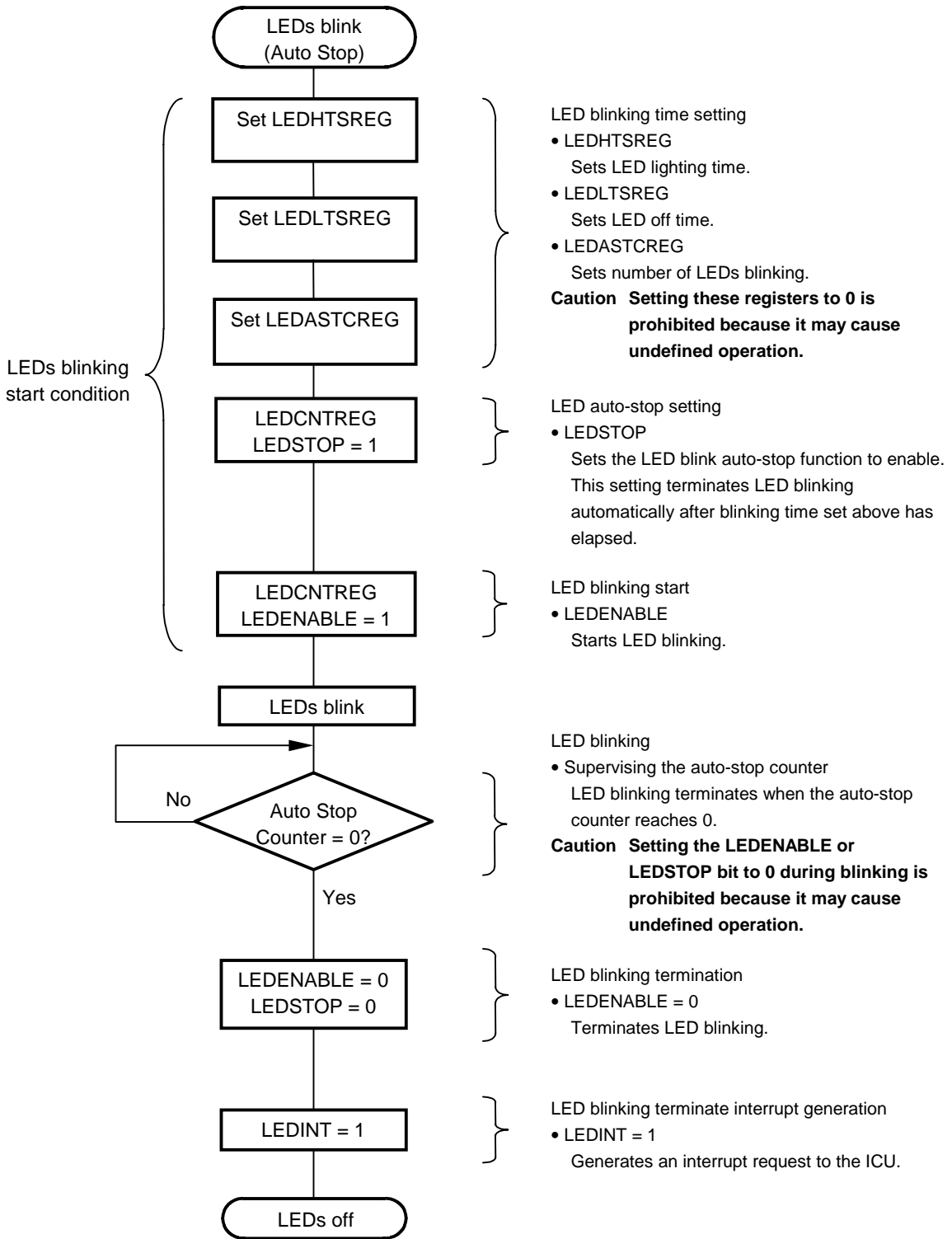

www.DataSheet4U.com

[MEMO]

CHAPTER 24 SIU (SERIAL INTERFACE UNIT)

This chapter describes the SIU's operations and register settings.

24.1 GENERAL

The SIU is a serial interface that conforms to the RS-232-C communication standard and is equipped with two one-channel interfaces, one for transmission and one for reception.

This unit is functionally compatible with the NS16550.

24.2 REGISTER SET

The SIU registers are listed below.

Table 24-1. SIU Registers

Address	LCR[7]	R/W	Register Symbols	Function
0x0C00 0000	0	R	SIURB	Receiver Buffer Register (Read)
		W	SIUTH	Transmitter Holding Register (Write)
	1	R/W	SIUDLL	Divisor Latch (Least Significant Byte)
0x0C00 0001	0	R/W	SIUIE	Interrupt Enable
	1	R/W	SIUDLM	Divisor Latch (Most Significant Byte)
0x0C00 0002	–	R	SIUIID	Interrupt Identification Register (Read)
		W	SIUFC	FIFO Control Register (Write)
0x0C00 0003	–	R/W	SIULC	Line Control Register
0x0C00 0004	–	R/W	SIUMC	MODEM Control Register
0x0C00 0005	–	R/W	SIULS	Line Status Register
0x0C00 0006	–	R/W	SIUMS	MODEM Status Register
0x0C00 0007	–	R/W	SIUSC	Scratch Register
0x0C00 0008	–	R/W	SIUIRSEL	SIU/FIR IrDA Selector

Remark LCR[7] is the bit 7 of SIULC register.

24.2.1 SIURB (0x0C00 0000: LCR[7] = 0, Read)

Bit	D7	D6	D5	D4	D3	D2	D1	D0
Name	RXD[7]	RXD[6]	RXD[5]	RXD[4]	RXD[3]	RXD[2]	RXD[1]	RXD[0]
R/W	R	R	R	R	R	R	R	R
RTCRST	0	0	0	0	0	0	0	0
Other resets	0	0	0	0	0	0	0	0

Bit	Name	Function
D[7..0]	RXD[7..0]	Serial receive data

This register stores receive data used in serial communications.
 To access this register, set LCR[7] (bit 7 of SIULC register) to 0.

24.2.2 SIUTH (0x0C00 0000: LCR[7] = 0, Write)

Bit	D7	D6	D5	D4	D3	D2	D1	D0
Name	TXD[7]	TXD[6]	TXD[5]	TXD[4]	TXD[3]	TXD[2]	TXD[1]	TXD[0]
R/W	W	W	W	W	W	W	W	W
RTCRST	0	0	0	0	0	0	0	0
Other resets	0	0	0	0	0	0	0	0

Bit	Name	Function
D[7..0]	TXD[7..0]	Serial transmit data

This register stores transmit data used in serial communications.
 To access this register, set LCR[7] (bit 7 of SIULC register) to 0.

24.2.3 SIUDLL (0x0C00 0000: LCR[7] = 1)

Bit	D7	D6	D5	D4	D3	D2	D1	D0
Name	DLL[7]	DLL[6]	DLL[5]	DLL[4]	DLL[3]	DLL[2]	DLL[1]	DLL[0]
R/W	R/W	R/W	R/W	R/W	R/W	R/W	R/W	R/W
RTCRST	0	0	0	0	0	0	0	0
Other resets	0	0	0	0	0	0	0	0

Bit	Name	Function
D[7..0]	DLL[7..0]	Baud rate generator divisor (low-order byte)

This register is used to set the divisor (division rate) for the baud rate generator.

The data in this register and the data in SIUDLM register on the high-order side are together handled as 16-bit data.

To access this register, set LCR[7] (bit 7 of SIULC register) to 1.

24.2.4 SIUIE (0x0C00 0001: LCR[7] = 0)

Bit	D7	D6	D5	D4	D3	D2	D1	D0
Name	Reserved	Reserved	Reserved	Reserved	IE[3]	IE[2]	IE[1]	IE[0]
R/W	R	R	R	R	R/W	R/W	R/W	R/W
RTCRST	0	0	0	0	0	0	0	0
Other resets	0	0	0	0	0	0	0	0

Bit	Name	Function
D[7,4]	Reserved	Write 0 when writing. 0 is returned after read.
D[3]	IE[3]	Modem status interrupt 1 : Interrupt enable 0 : Interrupt prohibit
D[2]	IE[2]	Receive status interrupt 1 : Interrupt enable 0 : Interrupt prohibit
D[1]	IE[1]	Transmitter holding register empty interrupt 1 : Interrupt enable 0 : Interrupt prohibit
D[0]	IE[0]	Receive data interrupt or timeout interrupt in FIFO mode 1 : Interrupt enable 0 : Interrupt prohibit

This register is used to specify interrupt enable/prohibit settings for the five types of interrupt used by the SIU.

These interrupts can be used to make the corresponding interrupt output signal (INTR) active.

Overall use of interrupt functions can be halted by setting bit 0 to bit 3 of the interrupt enable register (IER) to zero. If one or more of the bits from bit 0 to bit 3 has a value of 1, the corresponding interrupt is enabled.

When interrupts are prohibited, "pending" is not displayed in the IIR[0] bit even when the interrupt condition has been met and INTR output does not become active.

Other functions in the system are not affected even though interrupts are prohibited and the settings in the line status register and modem status register are valid.

To access this register, set LCR[7] (bit 7 of SIULC register) to 0.

24.2.5 SIUDLM (0x0C00 0001: LCR[7] = 1)

Bit	D7	D6	D5	D4	D3	D2	D1	D0
Name	DLM[7]	DLM[6]	DLM[5]	DLM[4]	DLM[3]	DLM[2]	DLM[1]	DLM[0]
R/W	R/W	R/W	R/W	R/W	R/W	R/W	R/W	R/W
RTCRST	0	0	0	0	0	0	0	0
Other resets	0	0	0	0	0	0	0	0

Bit	Name	Function
D[7..0]	DLM[7..0]	Baud rate generator divisor (high-order byte)

This register is used to set the divisor (division rate) for the baud rate generator.

The data in this register and the data in SIUDLL register on the low-order side are together handled as 16-bit data.

To access this register, set LCR[7] (bit 7 of SIULC register) to 1.

Table 24-2. Correspondence between Baud Rates and Divisors

Baud rate	Divisor
50	23040
75	15360
110	10473
134.5	8565
150	7680
300	3840
600	1920
1200	920
1800	640
2000	573
2400	480
3600	320
4800	240
7200	160
9600	120
19200	60
38400	30
56000	21
128000	9
144000	8
192000	6
230400	5
288000	4
384000	3
576000	2
1152000	1

24.2.6 SIUIID (0x0C00 0002: Read)

Bit	D7	D6	D5	D4	D3	D2	D1	D0
Name	IIR[7]	IIR[6]	Reserved	Reserved	IIR[3]	IIR[2]	IIR[1]	IIR[0]
R/W	R	R	R	R	R	R	R	R
RTCRST	0	0	0	0	0	0	0	1
Other resets	0	0	0	0	0	0	0	1

Bit	Name	Function
D[7..6]	IIR[7..6]	Becomes 11 when FCR0 = 1
D[5..4]	Reserved	Write 0 when writing. 0 is returned after read.
D[3]	IIR[3]	Pending character timeout interrupt (in FIFO mode) 1 : Pending interrupt 0 : No pending interrupt
D[2..1]	IIR[2..1]	Indicates the priority level of pending interrupt. See the following table.
D[0]	IIR[0]	Pending interrupts 1 : No pending interrupt 0 : Pending interrupt

This register indicates priority levels for interrupts and existence of pending interrupt.

From highest to lowest priority, these interrupts are receive line status, receive data ready, character timeout, transmit holding register empty, and modem status.

The contents of IIR[3] bit is valid only in FIFO mode, and it is always 0 in 16550 mode.

IIR[2] bit becomes 1 when IIR[3] bit is set to 1.

Table 24-3. Interrupt Function

SIUIID register			Interrupt set/reset function			
Bit3 ^{Note}	Bit2	Bit1	Priority level	Interrupt type	Interrupt source	Interrupt reset control
0	1	1	Highest (1st)	Receive line status	Overrun error, parity error, framing error, or break interrupt	Read line status register
0	1	0	2nd	Receive data ready	Receive data exists or has reached the trigger level.	Read the receive buffer register or lower trigger level via FIFO.
1	1	0	2nd	Character timeout	During the time period for the four most recent characters, not one character has been read from the receive FIFO nor has a character been input to the receive FIFO. During this period, at least one character has been held in the receive FIFO.	Read receive buffer register
0	0	1	3rd	Transmit holding register empty	Transmit register is empty	Read IIR (if it is the interrupt source) or write to transmit holding register
0	0	0	4th	Modem status	CTS#, DSR#, or DCD#	Read modem status register

Note FIFO mode only

24.2.7 SIUFC (0x0C00 0002: Write)

Bit	D7	D6	D5	D4	D3	D2	D1	D0
Name	FCR[7]	FCR[6]	Reserved	Reserved	FCR[3]	FCR[2]	FCR[1]	FCR[0]
R/W	W	W	R	R	W	W	W	W
RTCRST	0	0	0	0	0	0	0	0
Other resets	0	0	0	0	0	0	0	0

Bit	Name	Function
D[7..6]	FCR[7..6]	Receive FIFO trigger level 11 : 14 Bytes 10 : 08 Bytes 01 : 04 Bytes 00 : 00 Byte
D[5..4]	Reserved	Write 0 when writing. 0 is returned after read.
D[3]	FCR[3]	Switch between 16550 mode and FIFO mode 1 : From 16550 mode to FIFO mode 0 : From FIFO mode to 16550 mode
D[2]	FCR[2]	Transmit FIFO clear/counter clear. Cleared to 0 when 1 is written. 1 : FIFO clear/counter clear 0 : Normal
D[1]	FCR[1]	Receive FIFO clear/counter clear. Cleared to 0 when 1 is written. 1 : FIFO clear/counter clear 0 : Normal
D[0]	FCR[0]	Receive/Transmit FIFO enable 1 : Enable 0 : Disable

This register is used to control the FIFOs.

- **FIFO interrupt modes**

When receive FIFO is enabled and receive interrupts are enabled, receive interrupts can occur as described below.

1. When the FIFO is reached to the specified trigger level, a receive data ready interrupt occurs to inform the CPU.
This interrupt is cleared when the FIFO goes below the trigger level.
2. When the FIFO is reached to the specified trigger level, the SIUID register indicates a receive data ready interrupt.
As with the interrupt above, this interrupt is cleared when the FIFO goes below the trigger level.
3. Receive line status interrupts are assigned a higher priority level than are receive data ready interrupts.
4. When characters are transferred from the shift register to the receive FIFO, "1" is set to the LSR0 bit.
The value of this bit returns to "0" when the FIFO becomes empty.

When receive FIFO is use-enabled and receive interrupts are enabled, receive FIFO timeout interrupts can occur as described below.

1. The following are conditions under which FIFO timeout interrupts occur.
 - At least one character is being stored in the FIFO.
 - The time required for sending four characters has elapsed since the serial reception of the last character (includes the time for two stop bits in cases where a stop bit has been specified).
 - The time required for sending four characters has elapsed since the CPU last accessed the FIFO.
The time between receiving the last character and issuing a timeout interrupt is a maximum of 160 ms when operating at 300 baud and receiving 12-bit data.
2. The transfer time for a character is calculated based on the baud rate clock for reception (internal) input as clock signals (which is why the elapsed time is in proportion to the baud rate).
3. Once a timeout interrupt has occurred, the timeout interrupt is cleared and the timer is reset as soon as the CPU reads one character from the receive FIFO.
4. If no timeout interrupt has occurred, the timer is reset when a new character is received or when the CPU reads the receive FIFO.

When transmit FIFO is use-enabled and transmit interrupts are enabled, transmit interrupts can occur as described below.

1. When the transmit FIFO becomes empty, a transmit holding register empty interrupt occurs. This interrupt is cleared when a character is written to the transmit holding register (from one to 16 characters can be written to the transmit FIFO during servicing of this interrupt), or when the SIUID (interrupt ID register) is read.
2. If there are not at least two bytes of character data in the transmit FIFO between one time when LSR[5] = 1 (transmit FIFO is empty) and the next time when LSR[5] = 1, empty transmit FIFO status is reported to the IIR after a delay period calculated as “the time for one character – the time for the last stop bit(s).”
When transmit interrupts are enabled, the first transmit interrupt that occurs after the FCR0 (FIFO enable bit) is overwritten is indicated immediately.

The priority level of the character timeout interrupt and receive FIFO trigger level interrupt is the same as that of the receive data ready interrupt.

The priority level of the transmit FIFO empty interrupt is the same as that of the transmit holding register empty interrupt.

- **FIFO polling mode**

When FCR0 = 1 (FIFO is enabled), if the value of any or all of the interrupt enable register (SIUIE) bits 3 to 0 becomes “0”, the SIU enters FIFO polling mode. Because the transmit block and receive block are controlled separately, polling mode can be set for either or both blocks.

When in this mode, the status of the transmit block and/or receive block can be checked by reading the line status register (SIULS) via a user program.

When in FIFO polling mode, there is no notification when the trigger level is reached or when a timeout occurs, but the receive FIFO and transmit FIFO can still store characters as they normally do.

24.2.8 SIULC (0x0C00 0003)

Bit	D7	D6	D5	D4	D3	D2	D1	D0
Name	LCR[7]	LCR[6]	LCR[5]	LCR[4]	LCR[3]	LCR[2]	LCR[1]	LCR[0]
R/W	R/W	R/W	R/W	R/W	R/W	R/W	R/W	R/W
RTCRST	0	0	0	0	0	0	0	0
Other resets	0	0	0	0	0	0	0	0

Bit	Name	Function
D[7]	LCR[7]	Divisor latch access bit specification 1 : Divisor latch access 0 : Receive buffer, transmit holding register, interrupt enable register
D[6]	LCR[6]	Break control 1 : Set break 0 : Clear break
D[5]	LCR[5]	Parity fixing 1 : Fixed parity 0 : Parity not fixed
D[4]	LCR[4]	Parity setting 1 : Set one bit as odd bit 0 : Set one bit as even bit
D[3]	LCR[3]	Parity enable 1 : Create parity (during transmission) or check parity (during reception) 0 : No parity (during transmission) or no checking (during reception)
D[2]	LCR[2]	Stop bit specification 1 : 1.5 bits (character length is 5 bits) 2 bits (character length is 6, 7, or 8 bits) 0 : 1 bit
D[1..0]	LCR[1..0]	Specifies the length of one character (number of bits) 11 : 8 Bits 10 : 7 Bits 01 : 6 Bits 00 : 5 Bits

This register is used to specify the format for asynchronous data communication and exchange and to set the divisor latch access bit.

The setting of bit 5 becomes valid according to settings in bits 4 and 3.

Bit 6 is used to send the break status to the receive side's UART. When Bit6 = 1, the serial output (TxD) is forcibly set to the spacing (0) state.

24.2.9 SIUMC (0x0C00 0004)

Bit	D7	D6	D5	D4	D3	D2	D1	D0
Name	Reserved	Reserved	Reserved	MCR[4]	MCR[3]	MCR[2]	MCR[1]	MCR[0]
R/W	R	R	R	R/W	R/W	R/W	R/W	R/W
RTCRST	0	0	0	0	0	0	0	0
Other resets	0	0	0	0	0	0	0	0

Bit	Name	Function
D[7..5]	Reserved	Write 0 when writing. 0 is returned after read.
D[4]	MCR[4]	For diagnostic testing (local loopback) 1 : Enable use of local loopback 0 : Disable use of local loopback
D[3]	MCR[3]	OUT2 signal (internal) specification 1 : Output the low-level signal 0 : Output the high-level signal
D[2]	MCR[2]	OUT1 signal (internal) specification 1 : Output the low-level signal 0 : Output the high-level signal
D[1]	MCR[1]	RTS# output control 1 : Output the low-level signal 0 : Output the high-level signal
D[0]	MCR[0]	DTR# output control 1 : Output the low-level signal 0 : Output the high-level signal

This register is used for interface control with a modem or data set (or a peripheral device that emulates a modem). The settings of bit 3 and bit 2 become valid only when bit 4 is set to 1 (enable use of local loopback).

- **Local Loopback**

The local loopback can be used to test the transmit/receive data path in the SIU.

The following operation is executed when bit 4 value = 1.

The transmit block's serial output (TxD) enters the marking state (logical 1) and the serial input (RxD) to the receive block is cut off. The transmit shift register's output is looped back to the receive shift register's input.

The four modem control inputs (DSR#, CTS#, RI (internal), and DCD#) are cut off and the four modem control outputs (DTR#, RTS#, OUT1 (internal), and OUT2 (internal)) are internally connected to the corresponding modem control inputs.

The modem control output pins are forcibly set as inactive (high level). During this kind of loopback mode, transmitted data can be immediately and directly received.

This function can be used to check on the transmit/receive data bus within the SIU.

When in loopback mode, both transmission and receive interrupts can be used. The interrupt sources are external sources in relation to the transmit and receive blocks.

Although modem control interrupts can be used, the low-order four bits of the modem control register can be used instead of the four modem control inputs as interrupt sources.

As usual, each interrupt is controlled by an interrupt enable register.

24.2.10 SIULS (0x0C00 0005)

Bit	D7	D6	D5	D4	D3	D2	D1	D0
Name	LSR[7]	LSR[6]	LSR[5]	LSR[4]	LSR[3]	LSR[2]	LSR[1]	LSR[0]
R/W	R/W	R/W	R/W	R/W	R/W	R/W	R/W	R/W
RTCRST	0	1	1	0	0	0	0	0
Other resets	0	1	1	0	0	0	0	0

Bit	Name	Function
D[7]	LSR[7]	Indicates error detection (in FIFO mode) 1 : Parity error, framing error, or break is detected 0 : Normal
D[6]	LSR[6]	Transmit block empty 1 : No data in transmit holding register or transmit shift register No data in transmit FIFO (during FIFO mode) 0 : Data exists in transmit holding register or transmit shift register Data exists in transmit FIFO (during FIFO mode)
D[5]	LSR[5]	Transmit holding register empty 1 : Character is transferred to transmit shift register (during 16550 mode) Transmit FIFO is empty (during FIFO mode) 0 : Character is stored in transmit holding register (during 16550 mode) Transmit data exists in transmit FIFO (during FIFO mode)
D[4]	LSR[4]	Break interrupt 1 : Break interrupt detected 0 : Normal
D[3]	LSR[3]	Framing error 1 : Framing error detected 0 : Normal
D[2]	LSR[2]	Parity error 1 : Parity error detected 0 : Normal
D[1]	LSR[1]	Overrun error 1 : Overwrite receive data 0 : Normal
D[0]	LSR[0]	Receive data ready 1 : Receive data exists in FIFO 0 : No receive data in FIFO

The CPU uses this register to get information related to data transfers.

LSR[7] bit is valid only in FIFO mode, and it indicates always 0 in 16550 mode.

Bit4: Break interrupt

The value of bit 4 becomes 1 when the spacing mode (logical 0) is held longer than the time required for transmission of one word of receive data input (start bit + data bits + parity bit + stop bit).

This bit value returns "0" when the CPU reads the contents of the line status register.

When in FIFO mode, if a break interrupt is detected for one character in the FIFO, the character is regarded as an error character and the CPU is notified of a break interrupt when that character reaches the highest position in the FIFO.

When a break occurs, one "zero" character is sent to the FIFO. The RxD enters marking mode, and when the next valid start bit is received, the next character can be transmitted.

Bit3: Framing error

This indicates that the received character data did not include a correct stop bit.

The value of this becomes 1 when a zero (spacing level) stop bit is detected following the final data bit or parity bit. This bit value returns to 0 when the CPU reads the contents of the line status register.

When in FIFO mode, if a framing error is detected for one character in the FIFO, the character is regarded as an error character and the CPU is notified of a framing error when that character reaches the highest position in the FIFO.

When a framing error occurs, the SIU prepares for further synchronization. The next start bit is assumed to be the cause of the framing error and further data is not accepted until the next start bit has been sampled twice.

Bit2: Parity error

This error indicates that the received character data does not satisfy the even-parity or odd-parity setting specified by the even parity select bit.

The value of this becomes 1 when a parity error is detected. This bit value returns to 0 when the CPU reads the contents of the line status register.

When in FIFO mode, if a parity error is detected for one character within the FIFO, the character is regarded as an error character and the CPU is notified of a parity error when that character reaches the highest position in the FIFO.

Bit1: Overrun error (OE)

When the CPU transfers the next character to the receive buffer register before it reads the receive buffer register, the characters existing in that register are deleted.

The value of this bit becomes 1 when overrun status is detected and returns to "0" when the CPU reads the contents of the line status register.

When in FIFO mode, if the data exceeds the trigger level as it continues to be transferred to the FIFO, even after the FIFO becomes full an overrun error will not occur until all characters are stored in the shift register.

The CPU is notified as soon as an overrun error occurs. The characters in the shift register are overwritten and are not transferred to the FIFO.

24.2.11 SIUMS (0x0C00 0006)

Bit	D7	D6	D5	D4	D3	D2	D1	D0
Name	MSR[7]	MSR[6]	MSR[5]	MSR[4]	MSR[3]	MSR[2]	MSR[1]	MSR[0]
R/W	R	R	R	R	R/W	R/W	R/W	R/W
RTCRST	Undefined	Undefined	Undefined	Undefined	0	0	0	0
Other resets	Undefined	Undefined	Undefined	Undefined	0	0	0	0

Bit	Name	Function
D[7]	MSR[7]	Complement of DCD# signal 1 : High level 0 : Low level
D[6]	MSR[6]	Complement of RI signal (internal) 1 : High level 0 : Low level
D[5]	MSR[5]	Complement of DSR# input 1 : High level 0 : Low level
D[4]	MSR[4]	Complement of CTS# input 1 : High level 0 : Low level
D[3]	MSR[3]	DCD# signal change 1 : Change in DCD# signal 0 : No change
D[2]	MSR[2]	RI signal (internal) change 1 : Change in RI signal (internal) 0 : No change
D[1]	MSR[1]	DSR# signal change 1 : Change in DSR# signal 0 : No change
D[0]	MSR[0]	CTS# signal change 1 : Change in CTS# signal 0 : No change

This register indicates the current status of various control signals that are input to the CPU from a modem or other peripheral device.

MSR[3..0] bits are cleared to 0 when they are read.

24.2.12 SIUSC (0x0C00 0007)

Bit	D7	D6	D5	D4	D3	D2	D1	D0
Name	SCR[7]	SCR[6]	SCR[5]	SCR[4]	SCR[3]	SCR[2]	SCR[1]	SCR[0]
R/W	R/W	R/W	R/W	R/W	R/W	R/W	R/W	R/W
RTCRST	0	0	0	0	0	0	0	0
Other resets	0	0	0	0	0	0	0	0

Bit	Name	Function
D[7..0]	SCR[7..0]	Can be freely applied by user

This register is a readable/writable 8-bit register.

It does not affect control of the SIU.

24.2.13 SIUIRSEL (0x0C00 0008)

Bit	D7	D6	D5	D4	D3	D2	D1	D0
Name	Reserved	Reserved	TMICMODE	TMICTX	IRMSEL[1]	IRMSEL[0]	IRUSESEL	SIRSEL
R/W	R	R	R/W	R/W	R/W	R/W	R/W	R/W
RTCRST	0	0	0	0	0	0	0	0
Other resets	0	0	0	0	0	0	0	0

Bit	Name	Function
D[7..6]	Reserved	Write 0 when writing. 0 is returned after read.
D[5]	TMICMODE	Specifies the mode of the emitter or receptor module.
D[4]	TMICTX	Specifies the communication rate. 1 : Communication at 4 Mbps 0 : Communication at 1.15 Mbps or less
D[3..2]	IRMSEL[1..0]	Sets the type of emitter/receptor module to be used 11 : RFU 10 : HP model (HSDL-1100 is assumed) 01 : TEMIC model (TFDS6000 is assumed) 00 : SHARP model (RY5FD01D is assumed)
D[1]	IRUSESEL	Selects SIU or FIR for use with IrDA emitter/receptor module 1 : FIR uses IrDA module 0 : SIU uses IrDA module
D[0]	SIRSEL	Selects whether the SIU uses the IrDA module or the RS-232-C pins during communications 1 : Use IrDA module 0 : Use RS-232-C interface

This register is used to set the IrDA module settings, IrDA module access privileges, and the SIU's communication format (IrDA or serial).

The settings of TMICMODE and TMICTX bits are valid only when IRMSEL[1..0] bits are set to 01 (TEMIC model).

The figure below shows the connection examples between the VR4102 and IrDA modules.

Figure 24-1. Connection Example between the VR4102 and IrDA Module

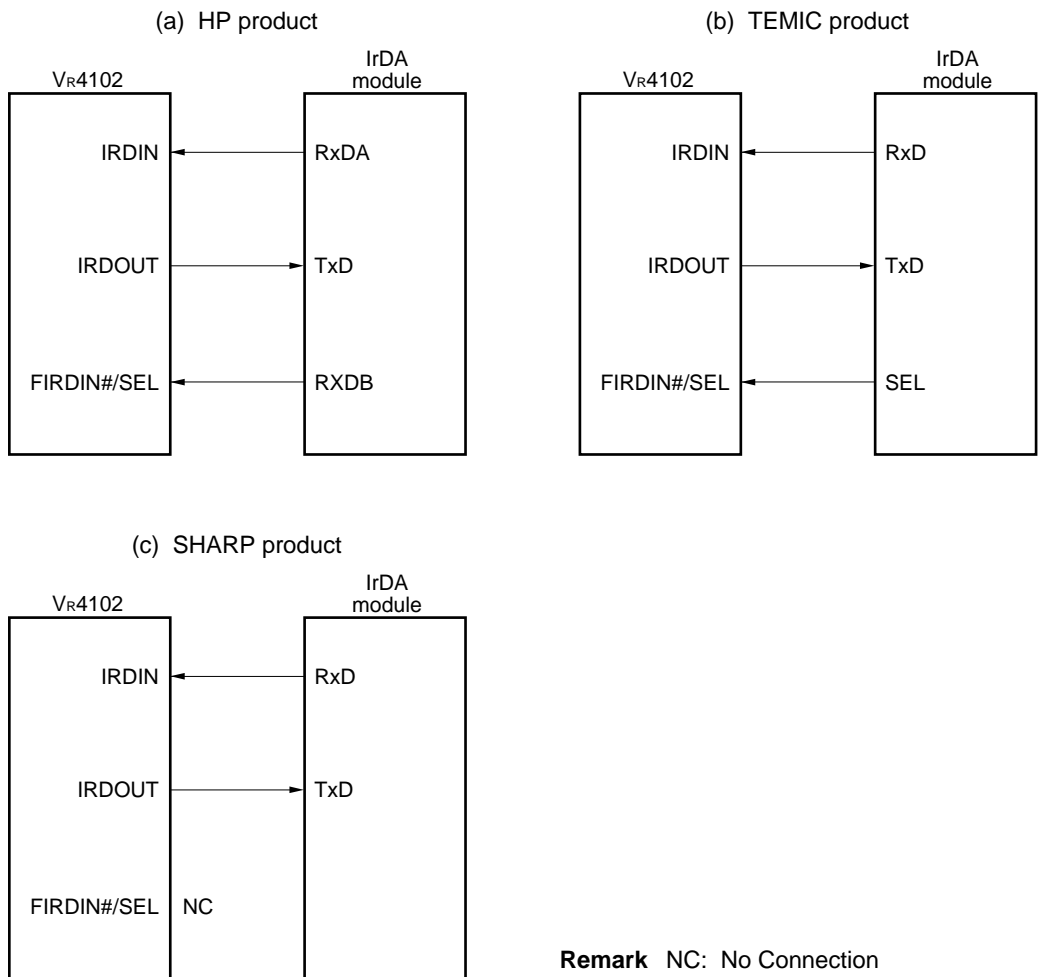

[MEMO]

www.DataSheet4U.com

CHAPTER 25 HSP (MODEM INTERFACE UNIT)

This chapter describes the HSP unit's operations and register settings.

25.1 GENERAL

The core of the HSP unit uses PCTel's PCT288I chip. The main functions of the PCT288I is as follows.

- <1> CODEC device control and serial ↔ parallel conversion of the CODEC transmit/receive data
- <2> Control of relay lines, hook lines, and other signal lines in DAA (Data Access Arrangement) block

www.DataSheet4U.com

Block diagrams of HSP unit and an example of connection between the VR4102 and external agents are shown below.

Figure 25-1. HSP Unit Block Diagram

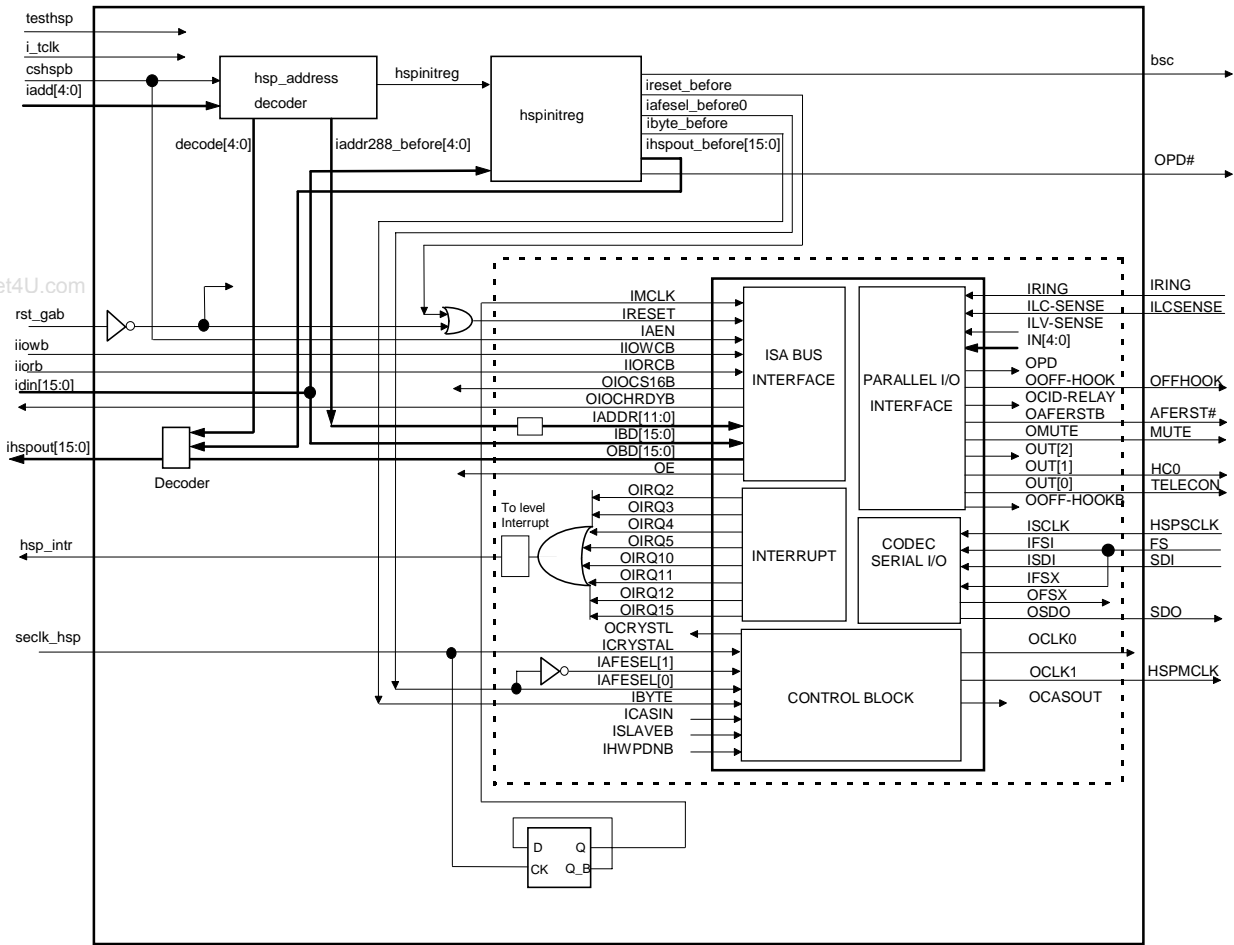
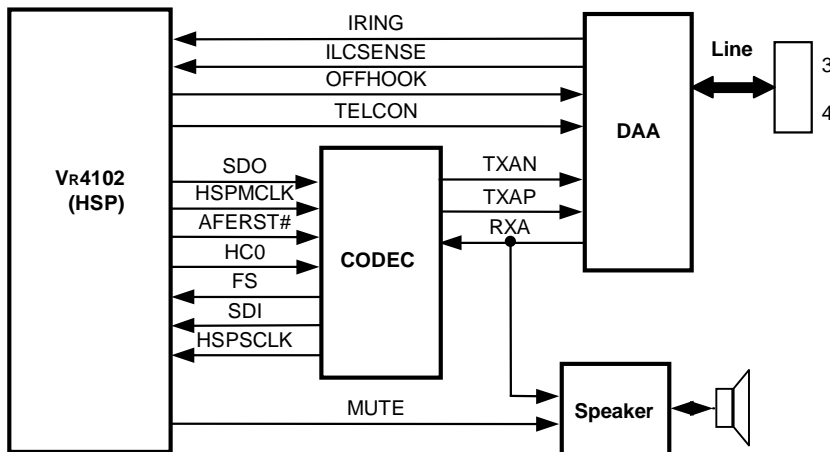

Figure 25-2. Circuit Configuration Block Diagram Examples



25.2 REGISTER SET

The HSP registers are listed below.

The data registers can be accessed as the control registers by specifying the INDEX number and then reading from or writing to.

All registers other than the HSPINIT register are original to the PCT2881.

Table 25-1. HSP Registers

Address	R/W	Register Symbols	Name
0x0C00 0020	R/W	HSPINIT	HSP Initialize Register
0x0C00 0022	R/W	HSPDATA[7:0]	HSP Data Register [7:0]
0x0C00 0023	R/W	HSPDATA[15:8]	HSP Data Register [15:8]
0x0C00 0024	W	HSPINDEX	HSP Index Register
0x0C00 0028	R	HSPID[7:0]	HSP ID Register
0x0C00 0029	R	HSPPCS[7:0]	HSP I/O Address Program Confirmation Register
0x0C00 0029	W	HSPPCTEL[7:0]	HSP Signature Checking Port

25.2.1 HSP Initialize Register

(1) HSPINIT (0x0C00 0020)

Bit	D15	D14	D13	D12	D11	D10	D9	D8
Name	Reserved	Reserved	Reserved	Reserved	Reserved	Reserved	Reserved	Reserved
R/W	R	R	R	R	R	R	R	R
RTCRST	0	0	0	0	0	0	0	0
Other resets	0	0	0	0	0	0	0	0

Bit	D7	D6	D5	D4	D3	D2	D1	D0
Name	Reserved	Reserved	Reserved	OPD	AFESSEL	BYTE	BSC	HSPRST
R/W	R	R	R	R/W	R/W	R/W	R/W	R/W
RTCRST	0	0	0	0	0	0	0	0
Other resets	0	0	0	0	0	0	0	0

Bit	Name	Function
D[15:5]	Reserved	Write 0 when writing. 0 is returned after read.
D[4]	OPD	Power-down CODEC (indicates OPD# pin's state) 1 : High level 0 : Low level
D[3]	AFESSEL	CODEC interface mode switch 1 : ST7546, STLC7546(SGS), T7525(AT) 0 : TLC320C44, TLC320AC01/02(TI)
D[2]	BYTE	HSP data bus width setting 1 : 8 bits 0 : 16 bits
D[1]	BSC	CODEC interface control 1 : Normal 0 : Initial value
D[0]	HSPRST	HSP unit reset (same as hardware reset) 1 : Reset 0 : Do not reset

This register is used to control the HSP.

BSC bit is used to control the CODEC interface. This bit must be set to 1 when using the HSP.

The hardware reset and the reset by the HSPRST bit result the same function.

25.2.2 HSP Data Register, HSP Index Register

HSPDATA[15..0] is a 16-bit data port. This register can be accessed as control registers according to the HSPINDEX[15..0] setting.

HSPINDEX[15..0] is a write-only index register. The role of the data register changes according to the values set to this register.

The correspondence between INDEX numbers and registers is shown below.

Table 25-2. Control Register Definitions

INDEX	WRITE		READ	
	Higher Byte	Lower Byte	Higher Byte	Lower Byte
0	HSPTxData[15..8]	HSPTxData[7..0]	HSPRxData[15..8]	HSPRxData[7..0]
1	HSPCNTL[9..8]	HSPCNTL[7..0]	HSPSTS[15..8]	HSPSTS[7..0]
2	Reserved	HSPEXTOUT[7..0]	HSPID[7..0]	HSPEXTIN[7..0]
3	HSPTOC[3..0]	HSPMCLK1[4..0]	HSPERRCNT[11..8]	HSPERRCNT[7..0]
4	Reserved	HSPFFSZ[6..0]	Reserved	
5 to 15	Reserved		Reserved	
16 to 255	Setting prohibited		Setting prohibited	

Described below are control registers.

(1) HSPTxData (0x0C00 0022: Index 0, Write)

Bit	D15	D14	D13	D12	D11	D10	D9	D8
Name	TxData[15]	TxData[14]	TxData[13]	TxData[12]	TxData[11]	TxData[10]	TxData[9]	TxData[8]
R/W	W	W	W	W	W	W	W	W
RTCRST	Undefined	Undefined	Undefined	Undefined	Undefined	Undefined	Undefined	Undefined
Other resets	Undefined	Undefined	Undefined	Undefined	Undefined	Undefined	Undefined	Undefined

Bit	D7	D6	D5	D4	D3	D2	D1	D0
Name	TxData[7]	TxData[6]	TxData[5]	TxData[4]	TxData[3]	TxData[2]	TxData[1]	TxData[0]
R/W	W	W	W	W	W	W	W	W
RTCRST	Undefined	Undefined	Undefined	Undefined	Undefined	Undefined	Undefined	Undefined
Other resets	Undefined	Undefined	Undefined	Undefined	Undefined	Undefined	Undefined	Undefined

Bit	Name	Function
D[15:0]	TxData[15:0]	Transmit data

(2) HSPCNTL (0x0C00 0022: Index 1, Write)

Bit	D15	D14	D13	D12	D11	D10	D9	D8
Name	Reserved	Reserved	Reserved	Reserved	Reserved	Reserved	Reserved	Reserved
R/W	W	W	W	W	W	W	W	W
RTCRST	0	0	Undefined	Undefined	Undefined	Undefined	Undefined	Undefined
Other resets	0	0	Undefined	Undefined	Undefined	Undefined	Undefined	Undefined

Bit	D7	D6	D5	D4	D3	D2	D1	D0
Name	NTORST	ENIRQ	START	Reserved	ENTX	IRQS2	IRQS1	IRQS0
R/W	W	W	W	W	W	W	W	W
RTCRST	0	0	0	0	0	0	0	0
Other resets	0	0	0	0	0	0	0	0

Bit	Name	Function
D[15:8]	Reserved	Write 0 when writing.
D[7]	NTORST	Disable timeout reset When this bit is "0", it enables a timeout to occur when a specified number of errors have been counted, at which point the HSP resets itself. 1 : Disable 0 : Enable
D[6]	ENIRQ	Interrupt enable 1 : Enable 0 : Disable
D[5]	START	RX/TX FIFO pointer initialization When this bit is set to "1", the RX/TX FIFO pointer is set to its initial position. 1 : Initialize (at rising edge) 0 : Status hold
D[4]	Reserved	Write 0 when writing.
D[3]	ENTX	Transfer enable 1 : Enable 0 : Disable
D[2:0]	IRQS[2:0]	Interrupt signal select. However, IRQ signal is always selected whatever value is set to these bits.

Caution If 1 is set to ENTX bit, the only way to stop the operation is by resetting the HSP unit.

(3) HSPEXTOUT (0x0C00 0022: Index 2, Write)

Bit	D15	D14	D13	D12	D11	D10	D9	D8
Name	Reserved	Reserved	Reserved	Reserved	Reserved	Reserved	Reserved	Reserved
R/W	W	W	W	W	W	W	W	W
RTCRST	Undefined	Undefined	Undefined	Undefined	Undefined	Undefined	Undefined	Undefined
Other resets	Undefined	Undefined	Undefined	Undefined	Undefined	Undefined	Undefined	Undefined

Bit	D7	D6	D5	D4	D3	D2	D1	D0
Name	Reserved	HC0	TELECON	Reserved	MUTE	AFERST	Reserved	OFFHOOK
R/W	W	W	W	W	W	W	W	W
RTCRST	Undefined	0	0	0	0	1	0	0
Other resets	Undefined	0	0	0	0	1	0	0

Bit	Name	Function
D[15:7]	Reserved	Write 0 when writing.
D[6]	HC0	Select CODEC mode This bit is connected to the HC0 pin. 1 : High-level signal output 0 : Low-level signal output
D[5]	TELECON	Hand set relay control This bit is connected to the TELECON pin. 1 : High-level signal output 0 : Low-level signal output
D[4]	Reserved	Write 0 when writing.
D[3]	MUTE	Mute speaker This bit is connected to the MUTE pin. 1 : High-level signal output 0 : Low-level signal output
D[2]	AFERST	CODEC reset This bit is connected to the AFERST# pin. 1 : High-level signal output 0 : Low-level signal output
D[1]	Reserved	Write 0 when writing.
D[0]	OFFHOOK	OFF HOOK relay control This bit is connected to the OFFHOOK pin. 1 : High-level signal output 0 : Low-level signal output

This register is used to set output values of various signals when the INDEX number is 2.

(4) HSPTOC and HSPMCLKD (0x0C00 0022: Index 3, Write)

Bit	D15	D14	D13	D12	D11	D10	D9	D8
Name	Reserved	Reserved	Reserved	Reserved	TOC3	TOC2	TOC1	TOC0
R/W	W	W	W	W	W	W	W	W
RTCRST	Undefined	Undefined	Undefined	Undefined	0	0	0	0
Other resets	Undefined	Undefined	Undefined	Undefined	0	0	0	0

Bit	D7	D6	D5	D4	D3	D2	D1	D0
Name	Reserved	Reserved	Reserved	MCLKD4	MCLKD3	MCLKD2	MCLKD1	MCLKD0
R/W	W	W	W	W	W	W	W	W
RTCRST	Undefined	Undefined	Undefined	1	1	1	1	0
Other resets	Undefined	Undefined	Undefined	1	1	1	1	0

Bit	Name	Function
D[15:12]	Reserved	Write 0 when writing.
D[11:8]	TOC[3:0]	High-order 4 bits of timeout count
D[7:5]	Reserved	Write 0 when writing.
D[4:0]	MCLKD[4:0]	HSPMCLK divisor to clock input HSPMCLK frequency = 18.432 MHz / (MCLKD[4:0] + 2)

The upper byte of this register sets the timeout counter value and lower byte sets the HSPMCLK's division ratio when the INDEX number is 3.

TOC[3:0] is used to set the high-order four bits of the final count of the timeout counter. The timeout counter is a 12-bit counter and is incremented once for each interrupt signal that is not serviced. The low-order 8 bits are automatically set to 0 when TOC[3:0] is set. When the specified timeout count value is reached, TO bit of HSPSTS register is set to 1. The user is responsible for resetting the HSP core to prevent a system hang-up.

MCLKD[4:0] is used to set the division ratio when the 18.432-MHz clock supplied to HSPMCLK pin can be output using a programmable division ratio. If MCLKD[4:0] is "0", there is no clock division and the 18.432-MHz clock is output. Note that an even number must be set to MCLKD[4:0].

(5) HSPFFSZ (0x0C00 0022: Index 4, Write)

Bit	D15	D14	D13	D12	D11	D10	D9	D8
Name	Reserved	Reserved	Reserved	Reserved	Reserved	Reserved	Reserved	Reserved
R/W	W	W	W	W	W	W	W	W
RTCRST	Undefined	Undefined	Undefined	0	0	0	0	0
Other resets	Undefined	Undefined	Undefined	0	0	0	0	0

Bit	D7	D6	D5	D4	D3	D2	D1	D0
Name	Reserved	Reserved	FFSZ5	FFSZ4	FFSZ3	FFSZ2	FFSZ1	FFSZ0
R/W	W	W	W	W	W	W	W	W
RTCRST	Undefined	Undefined	1	0	0	0	0	0
Other resets	Undefined	Undefined	1	0	0	0	0	0

Bit	Name	Function
D[15:6]	Reserved	Write 0 when writing.
D[5:0]	FFSZ[5:0]	FIFO size control

When the INDEX number is 4, this register is used to set the transmit/receive buffer size, and can be set up to 32 (0x20). If buffer-full interrupt is enabled, an interrupt will occur when the data in the transmit/receive buffer reaches to the size set in this register.

(6) HSPRxData (0x0C00 0022: Index 0, Read)

Bit	D15	D14	D13	D12	D11	D10	D9	D8
Name	RxData[15]	RxData[14]	RxData[13]	RxData[12]	RxData[11]	RxData[10]	RxData[9]	RxData[8]
R/W	R	R	R	R	R	R	R	R
RTCRST	Undefined	Undefined	Undefined	Undefined	Undefined	Undefined	Undefined	Undefined
Other resets	Undefined	Undefined	Undefined	Undefined	Undefined	Undefined	Undefined	Undefined

Bit	D7	D6	D5	D4	D3	D2	D1	D0
Name	RxData[7]	RxData[6]	RxData[5]	RxData[4]	RxData[3]	RxData[2]	RxData[1]	RxData[0]
R/W	R	R	R	R	R	R	R	R
RTCRST	Undefined	Undefined	Undefined	Undefined	Undefined	Undefined	Undefined	Undefined
Other resets	Undefined	Undefined	Undefined	Undefined	Undefined	Undefined	Undefined	Undefined

Bit	Name	Function
D[15:0]	RxData[15:0]	Receive data from the receive FIFO

This register is used to store the receive data from the receive FIFO when the INDEX number is 0.

(7) HSPSTS (0x0C00 0022: Index 1, Read)

Bit	D15	D14	D13	D12	D11	D10	D9	D8
Name	Reserved	Reserved	Reserved	Reserved	Reserved	Reserved	Reserved	Reserved
R/W	R	R	R	R	R	R	R	R
RTCRST	0	0	0	0	0	Undefined	Undefined	Undefined
Other resets	0	0	0	0	0	Undefined	Undefined	Undefined

Bit	D7	D6	D5	D4	D3	D2	D1	D0
Name	AFESEL1	AFESEL0	IBYTE	TO	CFGCP	IRQS	RxOVRUN	TxUDRUN
R/W	R	R	R	R	R	R	R	R
RTCRST	Undefined	Undefined	Undefined	0	0	0	0	0
Other resets	Undefined	Undefined	Undefined	0	0	0	0	0

Bit	Name	Function
D[15:8]	Reserved	0 is returned after read.
D[7:6]	AFESEL[1:0]	Indicates the AFESEL[1:0] signal (internal) state
D[5]	IBYTE	Indicates the BYTE signal (internal) state
D[4]	TO	Error-related timeout 1 : Timeout occurred 0 : No timeout
D[3]	CFGCP	CODEC configuration complete 1 : Complete 0 : Not complete
D[2]	IRQS	Pending interrupt exists 1 : Exists 0 : No pending interrupts
D[1]	RxOVRUN	Receive overrun occurred 1 : Occurred 0 : No receive overruns
D[0]	TxUDRUN	Transmit underrun occurred 1 : Occurred 0 : No transmit overruns

This register is used to indicate the status in communication when the INDEX number is 1.

TO bit is set (to "1") when the timeout counter reaches the value specified by the TOC bit of HSPTOC register.

CFGCP bit indicates whether or not CODEC initialization has been completed. Actually, this bit is set (to "1") when the START bit of HSPCNTL register has been set as active to reset the FIFO pointer and then 9-word data has been transmitted (1 word = 16 bits).

IRQS bit indicates whether or not any pending interrupt exists. When an interrupt request from HSP to the CPU core is in pending, the request is cleared after this register is read.

IRQS, RxOVRUN, TxUDRUN bits are cleared (to "0") when read.

(8) HSPID and HSPEXTIN (0x0C00 0022: Index 2, Read)

Bit	D15	D14	D13	D12	D11	D10	D9	D8
Name	ID7	ID6	ID5	ID4	ID3	ID2	ID1	ID0
R/W	R	R	R	R	R	R	R	R
RTCRST	0	0	0	1	0	0	0	0
Other resets	0	0	0	1	0	0	0	0

Bit	D7	D6	D5	D4	D3	D2	D1	D0
Name	Reserved	Reserved	Reserved	Reserved	Reserved	Reserved	ILCS	IRING
R/W	R	R	R	R	R	R	R	R
RTCRST	Undefined	Undefined	Undefined	Undefined	Undefined	Undefined	Undefined	Undefined
Other resets	Undefined	Undefined	Undefined	Undefined	Undefined	Undefined	Undefined	Undefined

Bit	Name	Function
D[15:8]	ID[7:0]	Indicates HSP unit's ID and revision number
D[7:2]	Reserved	0 is returned after read.
D[1]	ILCS	ILCSENSE input pin state indication
D[0]	IRING	IRING input pin state indication

The upper byte of this register is used to indicate the ID of HSP, and the lower byte is used to indicate the status of the HSP input signals.

ID[7:0] is divided into two parts. The high-order 4 bits ID[7:4] indicate the ID number of HSP, and the low-order 4 bits ID[3:0] indicate the revision number of HSP.

(9) HSPERRCNT (0x0C00 0022: Index 3, Read)

Bit	D15	D14	D13	D12	D11	D10	D9	D8
Name	Reserved	Reserved	Reserved	Reserved	ERRCNT11	ERRCNT10	ERRCNT9	ERRCNT8
R/W	R	R	R	R	R	R	R	R
RTCRST	0	0	0	0	0	0	0	0
Other resets	0	0	0	0	0	0	0	0

Bit	D7	D6	D5	D4	D3	D2	D1	D0
Name	ERRCNT7	ERRCNT6	ERRCNT5	ERRCNT4	ERRCNT3	ERRCNT2	ERRCNT1	ERRCNT0
R/W	R	R	R	R	R	R	R	R
RTCRST	0	0	0	0	0	0	0	0
Other resets	0	0	0	0	0	0	0	0

Bit	Name	Function
D[15:12]	Reserved	0 is returned after read.
D[11:0]	ERRCNT[11:0]	Error count

This register is used to indicate the number of errors when the INDEX number is 3.

This register indicates the number of overrun or underrun errors that have occurred. This is used for synchronizing software and hardware.

25.2.3 HSP ID Register, HSP I/O Address Program Confirmation Register

The specific values are displayed to HSPID[7:0] and HSPPCS[7:0] registers following normal access of HSPPCTEL register.

25.2.4 HSP Signature Checking Port

HSPPCTEL[7:0] register must be accessed when to start using HSP unit. 0xA5 can be read from the HSPPCS register by writing a certain value. Other registers cannot be accessed unless this processing is executed. It must be executed during initialization.

25.3 POWER CONTROL

Power control of the CODEC and AFE can be performed using the OPD# pin and the BSC bit (HSPINIT). The following is an example of a control method using these units.

Figure 25-3. Block Diagram of HSP Interface Power Control

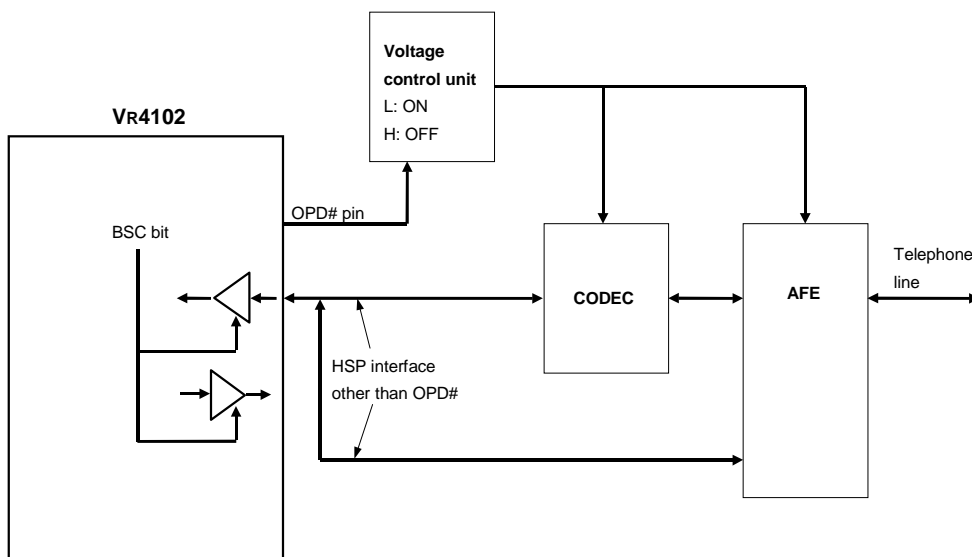

(1) After RTC reset

Item	OPD# pin	BSC bit	HSP bus state	Vr4102 power	CODEC/AFE power
1 When initialized	L	0	Note	ON	OFF
2 During power-on of CODEC or AFE	H	0	Note	ON	ON
3 When HSP bus's gate is set to "ON"	H	1	Normal	ON	ON
4 Software modem control	H	1	Normal	ON	ON

Note Refer to 2.3 PIN STATUS UPON A SPECIFIC STATE.

(2) During power-down (Vr4102: Fullspeed/Standby/Suspend mode)

Item	OPD# pin	BSC bit	HSP bus state	Vr4102 power	CODEC/AFE power
1 Operation complete	H	1	Normal	ON	ON
2 When HSP bus's gate is set to "OFF"	H	0	Note	ON	ON
3 When CODEC or AFE power is set to "OFF"	L	0	Note	ON	OFF
4 If necessary, execute STANDBY/ SUSPEND command	L	0	Note	ON	OFF

Note Refer to 2.3 PIN STATUS UPON A SPECIFIC STATE.

(3) During recovery from power-down (VR4102: Fullspeed/Standby/Suspend mode)

Item	OPD# pin	BSC bit	HSP bus state	VR4102 power	CODEC/AFE power
1 Power down status	L	0	Note	ON	OFF
2 During power-on of CODEC or AFE	H	0	Note	ON	ON
3 When HSP bus's gate is set to "ON"	H	1	Normal	ON	ON
4 Use HSP unit	H	1	Normal	ON	ON

Note Refer to 2.3 PIN STATUS UPON A SPECIFIC STATE.

www.DataSheet4U.com

(4) When changing to Hibernate mode (the following processing must occur before entering Hibernate mode)

Item	OPD# pin	BSC bit	HSP bus state	VR4102 power	CODEC/AFE power
1 Operation complete	H	1	Normal	ON	ON
2 When HSP bus's gate is set to "OFF"	H	0	Note	ON	ON
3 When CODEC or AFE power is set to "OFF"	L	0	Note	ON	OFF
4 Execute HIBERNATE command	L	0	Note	ON	OFF

Note Refer to 2.3 PIN STATUS UPON A SPECIFIC STATE.

(5) During recovery from Hibernate mode to use HSP unit

Item	OPD# pin	BSC bit	HSP bus state	VR4102 power	CODEC/AFE power
1 During Hibernate mode	L	0	Note	ON	OFF
2 During power-on of CODEC or AFE	H	0	Note	ON	ON
3 When HSP bus's gate is set to "ON"	H	1	Normal	ON	ON
4 Use HSP unit	H	1	Normal	ON	ON

Note Refer to 2.3 PIN STATUS UPON A SPECIFIC STATE.

[MEMO]

CHAPTER 26 FIR (FAST IrDA INTERFACE UNIT)

The FIR operation and register settings are described below.

26.1 GENERAL

This unit supports the IrDA 1.1 high-speed infrared communication physical layer standard. Supported FIR (Fast SIR) transfer rates include 0.576 Mbps, 1.152 Mbps, and 4 Mbps. SIR (up to 115.2 kbps) is not supported.

26.2 REGISTER SET

The FIR registers are listed below.

Table 26-1. FIR Registers

Address	R/W	Register symbols	Function
0x0C00 0040	R/W	FRSTR	FIR Reset register
0x0C00 0042	R/W	DPINTR	DMA Page Interrupt register
0x0C00 0044	R/W	DPCNTR	DMA Control register
0x0C00 0050	W	TDR	Transmit Data register
0x0C00 0052	R	RDR	Receive Data register
0x0C00 0054	R/W	IMR	Interrupt Mask register
0x0C00 0056	R/W	FSR	FIFO Setup register
0x0C00 0058	R/W	IRSR1	Infrared Setup register 1
0x0C00 005C	R/W	CRCSTR	CRC Setup register
0x0C00 005E	R/W	FIRCR	FIR Control register
0x0C00 0060	R/W	MIRCR	MIR Control register
0x0C00 0062	R/W	DMACR	DMA Control register
0x0C00 0064	R/W	DMAER	DMA Enable register
0x0C00 0066	R	TXIR	Transmit Indication register
0x0C00 0068	R	RXIR	Receive Indication register
0x0C00 006A	R	IFR	Interrupt Flag register
0x0C00 006C	R	RXSTS	Receive Status register
0x0C00 006E	R/W	TXFL	Transmit Frame Length
0x0C00 0070	R/W	MRXF	Maximum Receive Frame Length
0x0C00 0074	R	RXFL	Receive Frame Length register

These registers are described in detail below.

26.2.1 FRSTR (0x0C00 0040)

Bit	D15	D14	D13	D12	D11	D10	D9	D8
Name	Reserved	Reserved	Reserved	Reserved	Reserved	Reserved	Reserved	Reserved
R/W	R	R	R	R	R	R	R	R
RTCRST	0	0	0	0	0	0	0	0
Other resets	0	0	0	0	0	0	0	0

Bit	D7	D6	D5	D4	D3	D2	D1	D0
Name	Reserved	Reserved	Reserved	Reserved	Reserved	Reserved	Reserved	FRST
R/W	R	R	R	R	R	R	R	R/W
RTCRST	0	0	0	0	0	0	0	0
Other resets	0	0	0	0	0	0	0	0

Bit	Name	Function
D15 to D1	Reserved	Write 0 when writing. 0 is returned after a read.
D0	FRST	FIR reset. Set 0 when releasing reset. 0: Normal 1: Reset

26.2.2 DPINTR (0x0C00 0042)

Bit	D15	D14	D13	D12	D11	D10	D9	D8
Name	Reserved	Reserved	Reserved	Reserved	Reserved	Reserved	Reserved	Reserved
R/W	R	R	R	R	R	R	R	R
RTCRST	0	0	0	0	0	0	0	0
Other resets	0	0	0	0	0	0	0	0

Bit	D7	D6	D5	D4	D3	D2	D1	D0
Name	Reserved	Reserved	Reserved	FDPINT5	FDPINT4	FDPINT3	FDPINT2	FDPINT1
R/W	R	R	R	R	R/W	R/W	R/W	R/W
RTCRST	0	0	0	0	0	0	0	0
Other resets	0	0	0	0	0	0	0	0

Bit	Name	Function
D15 to D5	Reserved	Write 0 when writing. 0 is returned after a read.
D4	FDPINT5	This bit indicates an FIR macro interrupt occurs. Cleared to 0 when 1 is written. 0: Normal 1: Occurred
D3	FDPINT4	This bit indicates that the DMA buffer (receive side) becomes full (2 pages). Cleared to 0 when 1 is written. 0: Normal 1: Occurred (DMA request is stopped) Caution The last data of the transfer data is not guaranteed.
D2	FDPINT3	This bit indicates that the DMA buffer (transmit side) becomes full (2 pages). Cleared to 0 when 1 is written. 0: Normal 1: Occurred (DMA request is stopped) Caution The last data of the transfer data is not guaranteed.
D1	FDPINT2	This bit indicates that the DMA buffer (receive side) becomes full (1 page). Cleared to 0 when 1 is written. 0: Normal 1: Occurred (when bit 0 of DPCNTR is 1, DMA request is stopped) Caution When 1-page transfer is set, the last data of the transfer data is not guaranteed.
D0	FDPINT1	This bit indicates that the DMA buffer (transmit side) becomes full (1 page). Cleared to 0 when 1 is written. 0: Normal 1: Occurred (when bit 0 of DPCNTR is 1, DMA request is stopped) Caution When 1-page transfer is set, the last data of the transfer data is not guaranteed.

This register is used to indicate the generation of FIR's DMA page interrupt request.

26.2.3 DPCNTR (0x0C00 0044)

Bit	D15	D14	D13	D12	D11	D10	D9	D8
Name	Reserved	Reserved	Reserved	Reserved	Reserved	Reserved	Reserved	Reserved
R/W	R	R	R	R	R	R	R	R
RTCRST	0	0	0	0	0	0	0	0
Other resets	0	0	0	0	0	0	0	0

Bit	D7	D6	D5	D4	D3	D2	D1	D0
Name	Reserved	Reserved	Reserved	Reserved	Reserved	Reserved	Reserved	FPCNT
R/W	R	R	R	R	R	R	R	R/W
RTCRST	0	0	0	0	0	0	0	0
Other resets	0	0	0	0	0	0	0	0

Bit	Name	Function
D15 to D1	Reserved	Write 0 when writing. 0 is returned after a read.
D0	FPCNT	DMA transfer stopping boundary. 0: 2-page boundary (the last data of the second page is not guaranteed) 1: 1-page boundary (the last data of the first page is not guaranteed)

26.2.4 TDR (0x0C00 0050)

Bit	D15	D14	D13	D12	D11	D10	D9	D8
Name	Reserved	Reserved	Reserved	Reserved	Reserved	Reserved	Reserved	Reserved
R/W	W	W	W	W	W	W	W	W
RTCRST	0	0	0	0	0	0	0	0
Other resets	0	0	0	0	0	0	0	0

Bit	D7	D6	D5	D4	D3	D2	D1	D0
Name	TDR7	TDR6	TDR5	TDR4	TDR3	TDR2	TDR1	TDR0
R/W	W	W	W	W	W	W	W	W
RTCRST	0	0	0	0	0	0	0	0
Other resets	0	0	0	0	0	0	0	0

Bit	Name	Function
D15 to D8	Reserved	Write 0 when writing. 0 is returned after a read.
D7 to D0	TDR7 to 0	Transmit FIFO

[Function]

This register is used to store the address to which data is written for the transmit data store FIFO.

Up to 64- or 32-byte data (determined by bit 3 of FSR) is stored to the transmit data store FIFO.

Transmit data FIFO is used as follows.

(1) Write

Data is written to the transmit data store FIFO while the IrDA is operating.

When a write operation is completed, the write pointer of the transmit data store FIFO is incremented. However, if data is written when this write pointer is full, it is not incremented.

After the data of frame size is written to the TXFL register in a status other than the transmit busy status (start enable), if the data written to this register reaches frame size, data transfer starts even if the number of write to this register is short of the threshold.

This is Start 1.

After that, data is always transferred if it reaches frame size, even if it is short of the threshold. This is Start 2.

(2) Read

After frame transfer is completed, the sequencer reads the transmit data during the data transfer sequence, and the read pointer is incremented.

If read is done while the transmit FIFO is empty, a transmit underrun error occurs. This stops the current frame transmission and then starts the abort frame transmission. The following frames scheduled to be transmitted next are not transferred.

26.2.5 RDR (0x0C00 0052)

Bit	D15	D14	D13	D12	D11	D10	D9	D8
Name	Reserved	Reserved	Reserved	Reserved	Reserved	Reserved	Reserved	Reserved
R/W	R	R	R	R	R	R	R	R
RTCRST	0	0	0	0	0	0	0	0
Other resets	0	0	0	0	0	0	0	0

Bit	D7	D6	D5	D4	D3	D2	D1	D0
Name	RDR7	RDR6	RDR5	RDR4	RDR3	RDR2	RDR1	RDR0
R/W	R	R	R	R	R	R	R	R
RTCRST	0	0	0	0	0	0	0	0
Other resets	0	0	0	0	0	0	0	0

Bit	Name	Function
D15 to D8	Reserved	Write 0 when writing. 0 is returned after a read.
D7 to D0	RDR7 to 0	Receive FIFO

[Function]

This register is used to store the address from which data is read for the receive data store FIFO. Up to 64- or 32-byte data (determined by bit 3 of FSR) is stored to the receive data store FIFO. Receive data is used as follows.

(1) Write

During a frame data reception, the sequencer writes the receive data during the data transfer sequence, and the write pointer is incremented. If data is written when the unread data in the receive FIFO reaches the maximum volume, the receive overrun error occurs and the current frame reception is ended. The write pointer is not incremented. After the receive FIFO is cleared, if the number of received frames is less than 7 frames, it is possible to continue frame reception. To receive 8 or more frames, read all the data and frames that are already received from the receive FIFO, then clear the receive FIFO and restart reception.

(2) Read

Data is read from the receive data store FIFO while the IrDA is operating. When a read operation is completed, the read pointer of the receive data store FIFO is incremented. However, it is not incremented when the receive FIFO is empty. When the number of read frames reaches the receive frame size, an interrupt occurs and bit 7 of the RXSTS register is set to 1.

[Caution]

If data is read when the receive FIFO is empty (read pointer = write pointer), it may contend with the sequencer's write operation. This may cause undefined data. The error generated by read underrun is not reported in this macro.

26.2.6 IMR (0x0C00 0054)

Bit	D15	D14	D13	D12	D11	D10	D9	D8
Name	Reserved	Reserved	Reserved	Reserved	Reserved	Reserved	Reserved	Reserved
R/W	R	R	R	R	R	R	R	R
RTCRST	0	0	0	0	0	0	0	0
Other resets	0	0	0	0	0	0	0	0

Bit	D7	D6	D5	D4	D3	D2	D1	D0
Name	IMR7	IMR6	IMR5	IMR4	IMR3	IMR2	IMR1	IMR0
R/W	R/W	R/W	R/W	R/W	R/W	R/W	R/W	R/W
RTCRST	0	0	0	0	0	0	0	0
Other resets	0	0	0	0	0	0	0	0

Bit	Name	Function	
D15 to D8	Reserved	Write 0 when writing. 0 is returned after a read.	
D7 to D0	IMR7 to 0	These bits are used to enable/prohibit interrupt output. This register sets whether or not to inform outside when the interrupt is generated. Each bit corresponds to the equivalent IFR register bit. When interrupt output is enabled and corresponding bit is 1, interrupt output is active.	
		IMRn	Interrupt output
		0	Prohibit
		1	Enable

[Caution]

The IFR register is set irrespective of this register's setting.

26.2.7 FSR (0x0C00 0056)

Bit	D15	D14	D13	D12	D11	D10	D9	D8
Name	Reserved	Reserved	Reserved	Reserved	Reserved	Reserved	Reserved	Reserved
R/W	R	R	R	R	R	R	R	R
RTCRST	0	0	0	0	0	0	0	0
Other resets	0	0	0	0	0	0	0	0

Bit	D7	D6	D5	D4	D3	D2	D1	D0
Name	RX_TH1	RX_TH0	TX_TH1	TX_TH0	F_SIZE	TXF_CLR	RXF_CLR	TX_STOP
R/W	R/W	R/W	R/W	R/W	R/W	R/W	R/W	R/W
RTCRST	0	0	0	0	0	0	0	0
Other resets	0	0	0	0	0	0	0	0

Bit	Name	Function															
D15 to D8	Reserved	Write 0 when writing. 0 is returned after a read.															
D7 and D6	RX_TH1, 0	These bits are used to specify the receive FIFO's threshold.															
		<table border="1"> <thead> <tr> <th>RX_TH 1, 0</th> <th>F_SIZE = 0</th> <th>F_SIZE = 1</th> </tr> </thead> <tbody> <tr> <td>00</td> <td>1 byte</td> <td>1 byte</td> </tr> <tr> <td>01</td> <td>4 bytes</td> <td>8 bytes</td> </tr> <tr> <td>10</td> <td>16 bytes</td> <td>32 bytes</td> </tr> <tr> <td>11</td> <td>26 bytes</td> <td>48 bytes</td> </tr> </tbody> </table>	RX_TH 1, 0	F_SIZE = 0	F_SIZE = 1	00	1 byte	1 byte	01	4 bytes	8 bytes	10	16 bytes	32 bytes	11	26 bytes	48 bytes
		RX_TH 1, 0	F_SIZE = 0	F_SIZE = 1													
		00	1 byte	1 byte													
01	4 bytes	8 bytes															
10	16 bytes	32 bytes															
11	26 bytes	48 bytes															
D5 and D4	TX_TH1, 0	These bits are used to specify the transmit FIFO's threshold.															
<table border="1"> <thead> <tr> <th>TX_TH 1, 0</th> <th>F_SIZE = 0</th> <th>F_SIZE = 1</th> </tr> </thead> <tbody> <tr> <td>00</td> <td>1 byte</td> <td>1 byte</td> </tr> <tr> <td>01</td> <td>8 bytes</td> <td>16 bytes</td> </tr> <tr> <td>10</td> <td>16 bytes</td> <td>32 bytes</td> </tr> <tr> <td>11</td> <td>26 bytes</td> <td>48 bytes</td> </tr> </tbody> </table>		TX_TH 1, 0	F_SIZE = 0	F_SIZE = 1	00	1 byte	1 byte	01	8 bytes	16 bytes	10	16 bytes	32 bytes	11	26 bytes	48 bytes	
TX_TH 1, 0		F_SIZE = 0	F_SIZE = 1														
00		1 byte	1 byte														
01	8 bytes	16 bytes															
10	16 bytes	32 bytes															
11	26 bytes	48 bytes															
D3	F_SIZE	This bit is used to specify the maximum size of transmit/receive FIFO.															
		<table border="1"> <thead> <tr> <th>F_SIZE</th> <th>FIFO maximum size</th> </tr> </thead> <tbody> <tr> <td>0</td> <td>32 bytes</td> </tr> <tr> <td>1</td> <td>64 bytes</td> </tr> </tbody> </table>	F_SIZE	FIFO maximum size	0	32 bytes	1	64 bytes									
		F_SIZE	FIFO maximum size														
0	32 bytes																
1	64 bytes																
D2	TXF_CLR	Transmit FIFO clear trigger (read value = 0) When this bit is set to 1, the pointers of the transmit data FIFO and transmit frame size FIFO are initialized.															
D1	RXF_CLR	Receive FIFO clear trigger (read value = 0) When this bit is set to 1, the pointers of the receive data FIFO, receive frame size FIFO, and receive status FIFO are initialized.															
D0	TX_STOP	Transmission stop trigger (read value = 0) When this bit is set to 1, the current frame transmission is stopped and the abort frame transmission starts. The following frames scheduled to be transmitted next are not transferred. Setting 1 to this bit also stops DMA operation and generates the DMA completion interrupt.															

This register is used to specify the settings for the transmit/receive FIFOs.

[Caution]

During transmission/reception, the contents of bits 7 through 3 of the FSR register must not be changed (refresh is possible). The data in the FIFO is not cleared by FIFO clear.

Regardless of transmission/reception, after data transfer is completed, set the TX_STOP bit and stop the DMA operation. When reception, confirm the transfer data command bit and stop the DMA operation.

26.2.8 IRSR1 (0x0C00 0058)

Bit	D15	D14	D13	D12	D11	D10	D9	D8
Name	Reserved	Reserved	Reserved	Reserved	Reserved	Reserved	Reserved	Reserved
R/W	R	R	R	R	R	R	R	R
RTCST	0	0	0	0	0	0	0	0
Other resets	0	0	0	0	0	0	0	0

Bit	D7	D6	D5	D4	D3	D2	D1	D0
Name	IRDA_EN	Reserved	Reserved	Reserved	Reserved	Reserved	IRDA_MD	MIR_MD
R/W	R/W	R	R	R	R	R	R/W	R/W
RTCST	0	0	0	0	0	0	0	0
Other resets	0	0	0	0	0	0	0	0

Bit	Name	Function																				
D15 to D8	Reserved	Write 0 when writing. 0 is returned after a read.																				
D7	IRDA_EN	This bit is used to control (enable/prohibit) IrDA macro operation. When this bit is set to 1, peripheral main block's reset is released and clock supply starts. 0: Prohibit 1: Enable																				
D6 to D2	Reserved	Write 0 when writing. 0 is returned after a read.																				
D1 and D0	IRDA_MD/ MIR_MD	These bits are used to specify the IrDA/MIR mode.																				
		<table border="1"> <thead> <tr> <th>IRDA_MD</th> <th>MIR_MD</th> <th>Operation mode</th> <th>Frequency</th> <th>Modulation method</th> </tr> </thead> <tbody> <tr> <td>0</td> <td>1 or 0</td> <td>FIR mode</td> <td>8 MHz</td> <td>4 PPM</td> </tr> <tr> <td>1</td> <td>0</td> <td>MIR full mode</td> <td>1.152MHz</td> <td>Bit stream/stuff</td> </tr> <tr> <td>1</td> <td>1</td> <td>MIR half mode</td> <td>0.576 MHz</td> <td>Bit stream/stuff</td> </tr> </tbody> </table>	IRDA_MD	MIR_MD	Operation mode	Frequency	Modulation method	0	1 or 0	FIR mode	8 MHz	4 PPM	1	0	MIR full mode	1.152MHz	Bit stream/stuff	1	1	MIR half mode	0.576 MHz	Bit stream/stuff
		IRDA_MD	MIR_MD	Operation mode	Frequency	Modulation method																
0	1 or 0	FIR mode	8 MHz	4 PPM																		
1	0	MIR full mode	1.152MHz	Bit stream/stuff																		
1	1	MIR half mode	0.576 MHz	Bit stream/stuff																		

[Caution]

During transmission/reception, the contents of this register must not be changed (refresh is possible).

When the IRDA_EN bit is set, the peripheral main part reset is released and the clock supply starts.

Pulse output level changes according to operation mode changes.

The operation mode should be changed after changing the IrDA operation to prohibit state (by setting bit (bit 7) to 0).

Once the mode is changed, be sure to switch bit inversion of I/O data ON/OFF by setting bit 0 of the CRCSR register.

The output level does not change because output latch is reset.

Example) Sequence of changing operation mode from FIR mode to MIR full mode

```

clr1    0x7, IRSR1    Prohibit IrDA operation
set1    0x1, IRSR1    Change the mode
set1    0x0, CRCSR    Set bit inversion
set1    0x7, IRSR1    Enable IrDA operation
    
```

26.2.9 CRCSR (0x0C00 005C)

Bit	D15	D14	D13	D12	D11	D10	D9	D8
Name	Reserved	Reserved	Reserved	Reserved	Reserved	Reserved	Reserved	Reserved
R/W	R	R	R	R	R	R	R	R
RTCRST	0	0	0	0	0	0	0	0
Other resets	0	0	0	0	0	0	0	0

Bit	D7	D6	D5	D4	D3	D2	D1	D0
Name	TX_EN	RX_EN	4PPM_DIS	DPLL_DIS	Reserved	NON_CRC	CRC_INV	DATA_INV
R/W	R/W	R/W	R/W	R/W	R	R/W	R/W	R/W
RTCRST	0	0	0	0	0	1	0	0
Other resets	0	0	0	0	0	1	0	0

Bit	Name	Function
D15 to D8	Reserved	Write 0 when writing. 0 is returned after a read.
D7	TX_EN	This bit is used to control (enable/prohibit) masking of transmit start enable flag. Masking sequence transition to transmission enable state entered by writing the TXFL register is: 0: Prohibited 1: Enabled
D6	RX_EN	This bit is used to control (enable/prohibit) receive operation. Releasing masking of receive line, sampling data, and generating receive clocks are: 0: Prohibited 1: Enabled
D5	4PPM_DIS	This bit is used to control (enable/prohibit) the 4PPM modulation (for debugging). The 4PPM modulation of transmit data is: 0: Enabled 1: Prohibited
D4	DPLL_DIS	This bit is used to control (enable/prohibit) the bit correction (for debugging). Bit correction of received data is: 0: Enabled 1: Prohibited
D3	Reserved	Write 0 when writing. 0 is returned after a read.
D2	NON_CRC	This bit is used to control whether or not a CRC is added for frames to be transmitted (for debugging). 0: Add CRC 1: Do not add CRC

Bit	Name	Function
D1	CRC_INV	This bit is used to set whether or not a CRC is inverted to create an incorrect CRC in the normal routine. 0: Normal CRC (not inverted) 1: Inverted CRC
D0	DATA_INV	This bit is used to set whether or not received/transmitted data I/O is inverted. 0: Normal (not inverted) 1: Inverted Be sure to set as normal in FIR, and set as inverted in MIR.

[Caution]

During transmission/reception, the contents of this register must not be changed (refresh is possible).

26.2.10 FIRCR (0x0C00 005E)

Bit	D15	D14	D13	D12	D11	D10	D9	D8
Name	Reserved	Reserved	Reserved	Reserved	Reserved	Reserved	Reserved	Reserved
R/W	R	R	R	R	R	R	R	R
RTCRST	0	0	0	0	0	0	0	0
Other resets	0	0	0	0	0	0	0	0

Bit	D7	D6	D5	D4	D3	D2	D1	D0
Name	PA_LEN2	PA_LEN1	PA_LEN0	W_PULSE1	W_PULSE0	F_WIDTH2	F_WIDTH1	F_WIDTH0
R/W	R/W	R/W	R/W	R	R	R/W	R/W	R/W
RTCRST	1	0	0	0	0	1	0	1
Other resets	1	0	0	0	0	1	0	1

Bit	Name	Function		
D15 to D8	Reserved	Write 0 when writing. 0 is returned after a read.		
D7 to D5	PA_LEN2 to PA_LEN0	These bits are used to specify the number of PA (preamble) added to FIR's transmit frame.		
		PA_LEN2 to 0	Number of PA	
		001	1	
		010	2	
		011	4	
		100 (default)	16	
		111	32	
		Others	16 (reserved)	
D4 and D3	W_PULSE1 and W_PULSE0	These bits are used to specify the undefined receive pulse width area. Pulse width within the undefined receive pulse width area = recognized as single pulse Pulse width within other than the undefined receive pulse width area = recognized as double pulse		
		W_PULSE 1 and 0	Undefined receive pulse width area	
		00	7 to 8 clocks	
		01 (default)	8 to 9 clocks	
		10	9 to 10 clocks	
		11	10 to 11 clocks	
D2 to D0	F_WIDTH2 to F_WIDTH0	These bits are used to specify FIR pulse modulation width. The FIR's output pulse is modulated to a pulse consisting of the number of reference clocks (48 MHz) specified by these bits.		
		F_WIDTH2 to 0	Single pulse	Double pulse
		000	1 clock	7 clocks
		001	2 clocks	8 clocks
		010	3 clocks	9 clocks
		011	4 clocks	10 clocks
		100	5 clocks	11 clocks
101 (default)	6 clocks	12 clocks		
	Others	Setting prohibited		

[Function]

Controls the FIR operation.

[Caution]

During transmission/reception, the contents of this register must not be changed.

26.2.11 MIRCR (0x0C00 0060)

Bit	D15	D14	D13	D12	D11	D10	D9	D8
Name	Reserved	Reserved	Reserved	Reserved	Reserved	Reserved	Reserved	Reserved
R/W	R	R	R	R	R	R	R	R
RTCRST	0	0	0	0	0	0	0	0
Other resets	0	0	0	0	0	0	0	0

Bit	D7	D6	D5	D4	D3	D2	D1	D0
Name	STA_LEN2	STA_LEN1	STA_LEN0	M_WIDTH4	M_WIDTH3	M_WIDTH2	M_WIDTH1	M_WIDTH0
R/W	R/W	R/W	R/W	R/W	R/W	R/W	R/W	R/W
RTCRST	0	1	0	0	1	0	0	1
Other resets	0	1	0	0	1	0	0	1

Bit	Name	Function	
D15 to D8	Reserved	Write 0 when writing. 0 is returned after a read.	
D7 to D5	STA_LEN2 to STA_LEN0	These bits are used to specify the number of STA (start flag) added to MIR's transmit frame.	
		STA_LEN2 to 0	Number of STA
		001	1
		010 (default)	2
		011	4
		100	16
		111	32
		Others	2 (reserved)
D4 to D0	M_WIDTH4 to M_WIDTH0	These bits are used to specify the MIR pulse modulation width. The MIR's output pulse is modulated to a pulse consisting of the number of reference clocks (48 MHz) specified by these bits.	
		F_WIDTH4 to 0	Single pulse
		00000	1 clock
		00001	2 clocks
		:	:
		01001 (default)	10 clocks
		:	:
		10100	21 clocks
		:	:
		11111	32 clocks

[Function]

Controls the MIR operation.

The nominal pulse width of MIR is 1/4. Therefore, be sure to set as follows:

MIR full mode (1.152 MHz) = 01001 (rate 10/42)

MIR half mode (0.576 MHz) = 10100 (rate 21/83)

[Caution]

During transmission/reception, the contents of this register must not be changed.

26.2.12 DMACR (0x0C00 0062)

Bit	D15	D14	D13	D12	D11	D10	D9	D8
Name	Reserved	Reserved	Reserved	Reserved	Reserved	Reserved	Reserved	Reserved
R/W	R	R	R	R	R	R	R	R
RTCST	0	0	0	0	0	0	0	0
Other resets	0	0	0	0	0	0	0	0

Bit	D7	D6	D5	D4	D3	D2	D1	D0
Name	ACES_MD	TRANS_MD	Reserved	Reserved	Reserved	DEMAND2	DEMAND1	DEMAND0
R/W	R/W	R/W	R	R	R	R/W	R/W	R/W
RTCST	0	0	0	0	0	0	0	0
Other resets	0	0	0	0	0	0	0	0

Bit	Name	Function
D15 to D8	Reserved	Write 0 when writing. 0 is returned after a read.
D7	ACES_MD	This bit is used to select the access mode. Write 0 when writing. 0 is returned after a read.
D6	TRANS_MD	This bit is used to specify the transfer direction.
		TRANS_MD Transfer direction
		0 Memory → TDR 1 RDR → Memory
D5 to D3	Reserved	Write 0 when writing. 0 is returned after a read.
D2 to D0	DEMAND2 to DEMAND0	These bits are used to specify the demand size.
		DEMAND2 to 0 Demand size
		000 1
		001 2
		010 3
		011 4
		100 5
		101 6
110 7		
111 Free size		

[Caution]

During the DMA operation (both the master side and IrDA side), the contents of this register must not be changed.

26.2.13 DMAER (0x0C00 0064)

Bit	D15	D14	D13	D12	D11	D10	D9	D8
Name	Reserved	Reserved	Reserved	Reserved	Reserved	Reserved	Reserved	Reserved
R/W	R	R	R	R	R	R	R	R
RTCRST	0	0	0	0	0	0	0	0
Other resets	0	0	0	0	0	0	0	0

Bit	D7	D6	D5	D4	D3	D2	D1	D0
Name	Reserved	Reserved	Reserved	Reserved	Reserved	Reserved	DMA_BUSY	DMA_EN
R/W	R	R	R	R	R	R	R	R/W
RTCRST	0	0	0	0	0	0	0	0
Other resets	0	0	0	0	0	0	0	0

Bit	Name	Function
D15 to D2	Reserved	Write 0 when writing. 0 is returned after a read.
D1	DMA_BUSY	DMA busy status 1: Busy 0: Not Busy
D0	DMA_EN	This bit is used as a DMA operation enable trigger. 1: Enable 0: Disable Note that the DMA is not stopped by clearing this bit (to 0).

[Function]

The DMA_BUSY bit is set automatically by setting the DMA_EN bit to 1.

The DMA_BUSY bit is cleared when bit 0 of the FSR register is set or when all frame transmit data is written.

26.2.14 TXIR (0x0C00 0066)

Bit	D15	D14	D13	D12	D11	D10	D9	D8
Name	Reserved	Reserved	Reserved	Reserved	Reserved	Reserved	Reserved	Reserved
R/W	R	R	R	R	R	R	R	R
RTCRST	0	0	0	0	0	0	0	0
Other resets	0	0	0	0	0	0	0	0

Bit	D7	D6	D5	D4	D3	D2	D1	D0
Name	TX_BUSY	Reserved	LAST_TFL	TX_TH_OV	Reserved	TXF_UNDR	TXF_FULL	TXF_EMP
R/W	R	R	R	R	R	R	R	R
RTCRST	0	0	0	0	0	0	0	0
Other resets	0	0	0	0	0	0	0	0

Bit	Name	Function
D15 to D8	Reserved	Write 0 when writing. 0 is returned after a read.
D7	TX_BUSY	Transmission busy. This bit is set to 1 during the period between PA (in FIR) or STA (in MIR) transmission and abort transmission. 0: Not Busy 1: Busy
D6	Reserved	Write 0 when writing. 0 is returned after a read.
D5	LAST_TFL	Last transmission frame status. This bit indicates whether data exists or not in the transmission frame size FIFO. This bit changes when the STA transmission sequence ends. Its initial value is 1. 0: Normal 1: Exists
D4	TX_TH_OV	Transmission FIFO threshold over status. This bit indicates whether or not the data size within the transmission FIFO exceeds the threshold. 0: Normal 1: Excesses
D3	Reserved	Write 0 when writing. 0 is returned after a read.
D2	TXF_UNDR	Transmission FIFO underrun status. This bit indicates whether or not data is read when there is no data in the transmission FIFO. 0: Normal 1: Data is read
D1	TXF_FULL	Transmission FIFO full status. This bit indicates that there is no writable space in the transmission FIFO. 0: Normal 1: No writable space
D0	TXF_EMP	Transmission FIFO empty status. This bit indicates whether or not data to be read exists in the transmission FIFO. 0: Normal 1: Exists

26.2.15 RXIR (0x0C00 0068)

Bit	D15	D14	D13	D12	D11	D10	D9	D8
Name	Reserved	Reserved	Reserved	Reserved	Reserved	Reserved	Reserved	Reserved
R/W	R	R	R	R	R	R	R	R
RTCRST	0	0	0	0	0	0	0	0
Other resets	0	0	0	0	0	0	0	0

Bit	D7	D6	D5	D4	D3	D2	D1	D0
Name	RX_BUSY	END_DATA	LAST_RFL	RX_TH_O	Reserved	Reserved	RXF_FULL	RXF_EMP
R/W	R	R	R	R	R	R	R	R
RTCRST	0	0	0	0	0	0	0	0
Other resets	0	0	0	0	0	0	0	0

Bit	Name	Function
D15 to D8	Reserved	Write 0 when writing. 0 is returned after a read.
D7	RX_BUSY	Reception busy. This bit is set to 1 during the period between when PA (in FIR) or STA (in MIR) is detected and when reception ends. 0: Not Busy 1: Busy
D6	END_DATA	Frame last data status. This bit indicates whether the last data of frame that is received completely exists or not in the FIFO. 0: Normal 1: Exists
D5	LAST_RFL	Last reception frame status. This bit is set (to 1) when the reception result (frame size and status) of the 7th frame is stored. 0: Normal 1: Result is stored
D4	RX_TH_O	Reception FIFO threshold over status. This bit indicates whether or not the data size within the reception FIFO exceeds the threshold. 0: Normal 1: Excesses
D3 and D2	Reserved	Write 0 when writing. 0 is returned after a read.
D1	RXF_FULL	Reception FIFO full status. This bit indicates that there is no writable space in the reception FIFO. 0: Normal 1: No writable space
D0	RXF_EMP	Reception FIFO empty status. This bit indicates whether or not data to be read exists in the reception FIFO. 0: Normal 1: Exists

[Caution]

This register can be read only in IrDA mode.

[Remark]

Initial value is the value immediately after the IrDA operation is enabled or after the reception FIFO is cleared. 0x00 is read while the operation stops.

26.2.16 IFR (0x0C00 006A)

Bit	D15	D14	D13	D12	D11	D10	D9	D8
Name	Reserved	Reserved	Reserved	Reserved	Reserved	Reserved	Reserved	Reserved
R/W	R	R	R	R	R	R	R	R
RTCRST	0	0	0	0	0	0	0	0
Other resets	0	0	0	0	0	0	0	0

Bit	D7	D6	D5	D4	D3	D2	D1	D0
Name	TX_ABORT	TX_ERR	RX_VALID	DMA_END	RX_END	TX_END	TX_WR_RQ	RX_RD_RQ
R/W	R	R	R	R	R	R	R	R
RTCRST	0	0	0	0	0	0	0	0
Other resets	0	0	0	0	0	0	0	0

Bit	Name	Function
D15 to D8	Reserved	Write 0 when writing. 0 is returned after a read.
D7	TX_ABORT	Abort frame transmission end interrupt. This bit indicates that abort frame is transmitted and the following frame's transfer reservation is cancelled. 0: Normal 1: Cancelled
D6	TX_ERR	Transmission error interrupt. This bit indicates that the transmission error occurs. 0: Normal 1: Occurs
D5	RX_VALID	Reception result valid interrupt. This bit indicates that the last data of frame is read from the reception FIFO and the received status becomes valid. 0: Normal 1: Valid
D4	DMA_END	DMA end interrupt. This bit indicates that the DMA operation ends. 0: Normal 1: Ends
D3	RX_END	Reception end interrupt. This bit indicates that STO is detected for each reception frame. 0: Normal 1: Detected
D2	TX_END	Transmission end interrupt. This bit indicates that STO is transmitted for each transmission frame. 0: Normal 1: Detected

Bit	Name	Function
D1	TX_WR_RQ	Transmission data write request interrupt. This bit indicates that a transmission data write request interrupt has occurred. 0: Normal 1: Occurs
D0	RX_RD_RQ	Reception data read request interrupt. This bit indicates that a reception data read request interrupt has occurred. 0: Normal 1: Occurs

[Caution]

www.DataSheet4U.com If bits 7 through 2 of the IFR register are set, the flags that are set to 1 before a read are all cleared to 0.

26.2.17 RXSTS (0x0C00 006C)

Bit	D15	D14	D13	D12	D11	D10	D9	D8
Name	Reserved	Reserved	Reserved	Reserved	Reserved	Reserved	Reserved	Reserved
R/W	R	R	R	R	R	R	R	R
RTCRST	0	0	0	0	0	0	0	0
Other resets	0	0	0	0	0	0	0	0

Bit	D7	D6	D5	D4	D3	D2	D1	D0
Name	Valid	Reserved	Reserved	RXF_OV	CRC_ERR	ABORT	MRXF_OV	Reserved
R/W	R	R	R	R	R	R	R	R
RTCRST	0	0	0	0	0	0	0	0
Other resets	0	0	0	0	0	0	0	0

Bit	Name	Function
D15 to D8	Reserved	Write 0 when writing. 0 is returned after a read.
D7	Valid	Valid status in the indication status. This bit is set to 1 when received data of one frame is read completely. 0: Received data read not completed 1: Received data read completed
D6 and D5	Reserved	Write 0 when writing. 0 is returned after a read.
D4	RXF_OV	Receive FIFO overrun error. This bit is set to 1 when a receive operation is stopped by receive FIFO's overrun. 0: Normal 1: Overrun
D3	CRC_ERR	CRC Error. This bit is set to 1 when the receive result CRC does not match with expected value. 0: Normal 1: CRC error
D2	ABORT	Abort detection error. This bit is set to 1 when a receive operation is stopped by abort frame detection. 0: Normal 1: Abort error
D1	MRXF_OV	Maximum receive frame size error. This bit is set to 1 when a receive operation is stopped by maximum receive frame size overrun. 0: Normal 1: Overrun
D0	Reserved	Write 0 when writing. 0 is returned after a read.

[Function]

Reads data from the receive status store FIFO, in which data of up to 7 frames can be stored.

The FIFO is initialized by setting bit 1 of the FSR register.

Received status FIFO is used as follows.

(1) Write (bits 4 to 1)

The receive status is written to this register at the same timing of writing data to the receive frame length register.

This register shares the write pointer with the receive frame length register.

(2) Write (bit 7)

This bit is set to 1 when the data of receive frame size is read from the FIFO. While this bit is 1, data is recognized as valid.

(3) Read

This register shares the read pointer with the receive frame length register.

The read pointer is incremented by reading the RXFL (receive frame length) register after valid data is read from this register.

26.2.18 TXFL (0x0C00 006E)

Bit	D15	D14	D13	D12	D11	D10	D9	D8
Name	Reserved	Reserved	Reserved	TXFL12	TXFL11	TXFL10	TXFL9	TXFL8
R/W	R	R	R	R/W	R/W	R/W	R/W	R/W
RTCRST	0	0	0	0	0	0	0	0
Other resets	0	0	0	0	0	0	0	0

Bit	D7	D6	D5	D4	D3	D2	D1	D0
Name	TXFL7	TXFL6	TXFL5	TXFL4	TXFL3	TXFL2	TXFL1	TXFL0
R/W	R/W	R/W	R/W	R/W	R/W	R/W	R/W	R/W
RTCRST	0	0	0	0	0	0	0	0
Other resets	0	0	0	0	0	0	0	0

Bit	Name	Function
D15 to D13	Reserved	Write 0 when writing. 0 is returned after a read.
D12 to D0	TXFL12 to TXFL0	Transmit frame size.

[Function]

This register functions as prebuffer address for data write to the transmit frame size data store FIFO, in which data of up to 7 frames can be stored.

Setting value = transmit size – 1

Setting range = 1 to 2 Kbytes

The FIFO is initialized by setting bit 2 of the FSR register.

(1) Write

The data transmit size of frames to be transferred is written to this register.

Transmission is enabled when data is written to this register in the state other than transmission busy state (after FIFO initialization and after transmission completion).

The frames whose number is specified by this register are transferred continuously (back-to-back transfer).

During the single frame transfer, FIFO should be initialized at each 1-frame transfer completion to restart transmit operation.

(2) Read

The sequencer reads the transmission size from this register after the STA flag of transmission frame is transmitted completed. Then, the read pointer is incremented.

[Caution]

If data exists in the FIFO when the STO transmit sequence is completed, continuous transfer mode is entered. When multiple frames are transferred, be sure to write data to the TXFL register before the STO transmit sequence is completed.

26.2.19 MRXF (0x0C00 0070)

Bit	D15	D14	D13	D12	D11	D10	D9	D8
Name	Reserved	Reserved	Reserved	MRXF12	MRXF11	MRXF10	MRXF9	MRXF8
R/W	R	R	R	R/W	R/W	R/W	R/W	R/W
RTCRST	0	0	0	0	0	0	0	0
Other resets	0	0	0	0	0	0	0	0

Bit	D7	D6	D5	D4	D3	D2	D1	D0
Name	MRXF7	MRXF6	MRXF5	MRXF4	MRXF3	MRXF2	MRXF1	MRXF0
R/W	R/W	R/W	R/W	R/W	R/W	R/W	R/W	R/W
RTCRST	0	0	0	0	0	0	0	0
Other resets	0	0	0	0	0	0	0	0

Bit	Name	Function	
D15 to D13	Reserved	Write 0 when writing. 0 is returned after a read.	
D12 to D0	MRXF12 to MRXF0	Specifies receivable maximum frame size.	
		MRXF	MAX Tx Frame length
		0x0000	1 byte
		0x0001	2 bytes
		:	:
	0x1FFF	2 Kbytes	

[Function]

The maximum frame size is stored in this register.

When a 1-frame receive data is transferred to the receive FIFO exceeding the receivable maximum frame size set by this register, an error occurs even under frame reception to end the current frame reception. This sets bit 1 of the RXSTS register.

After the receive FIFO is cleared, if the number of received frames is less than 7 frames, it is possible to continue frame reception.

To receive 8 or more frames, read all the data and frames that are already received from the receive FIFO, then clear the receive FIFO and restart reception.

When receiving data via the DMA operation, set the transfer size value by the following expression:

$$\text{DMA receivable capacitance} = \text{set value} \times 7 \text{ frames}$$

Caution The data exceeding the maximum size cannot be transferred to the FIFO.

26.2.20 RXFL (0x0C00 0074)

Bit	D15	D14	D13	D12	D11	D10	D9	D8
Name	Reserved	Reserved	Reserved	RXFL12	RXFL11	RXFL10	RXFL9	RXFL8
R/W	R	R	R	R	R	R	R	R
RTCRST	0	0	0	0	0	0	0	0
Other resets	0	0	0	0	0	0	0	0

Bit	D7	D6	D5	D4	D3	D2	D1	D0
Name	RXFL7	RXFL6	RXFL5	RXFL4	RXFL3	RXFL2	RXFL1	RXFL0
R/W	R	R	R	R	R	R	R	R
RTCRST	0	0	0	0	0	0	0	0
Other resets	0	0	0	0	0	0	0	0

Bit	Name	Function
D15 to D13	Reserved	Write 0 when writing. 0 is returned after a read.
D12 to D0	RXFL12 to RXFL0	Receive frame size.

[Function]

This register functions as prebuffer address for data read from the receive frame size data store FIFO, in which data of up to 7 frames can be stored.

Setting value = transmit size – 1

Setting range = 1 to 2 Kbytes

The FIFO is initialized by setting bit 1 of the FSR register.

(1) Write

When the frame reception is completed after its data is transferred (even if only 1 byte) to the receive FIFO, the sequencer writes the current transfer data size to this register, and the write pointer is incremented.

When the frame reception is completed before its data is transferred to the receive FIFO, write operation is not performed (lost frame).

(2) Read

The read pointer is enabled to be incremented by reading valid data from the RXSTS register, and the next data can be read.

[Caution]

If a receive operation ends abnormally, the data size transferred to the receive FIFO at that time is written to this register.

When the data of 7 frames are stored, the receive line is automatically masked. Therefore, the frame whose receive result cannot be stored is not transferred to the FIFO.

The update condition of the read pointer of the receive frame size store FIFO is also valid in the test mode.

[MEMO]

CHAPTER 27 CPU INSTRUCTION SET DETAILS

This chapter provides a detailed description of the operation of each VR4102 instruction in both 32- and 64-bit modes. The instructions are listed in alphabetical order.

27.1 INSTRUCTION NOTATION CONVENTIONS

In this chapter, all variable subfields in an instruction format (such as *rs*, *rt*, *immediate*, etc.) are shown in lowercase names.

For the sake of clarity, we sometimes use an alias for a variable subfield in the formats of specific instructions. For example, we use *rs* = *base* in the format for load and store instructions. Such an alias is always lower case, since it refers to a variable subfield.

Figures with the actual bit encoding for all the mnemonics are located at the end of this chapter, and the bit encoding also accompanies each instruction.

In the instruction descriptions that follow, the Operation section describes the operation performed by each instruction using a high-level language notation. The VR4102 can operate as either a 32- or 64-bit microprocessor and the operation for both modes is included with the instruction description.

Special symbols used in the notation are described in Table 27-1.

Table 27-1. CPU Instruction Operation Notations

Symbol	Meaning
<-	Assignment.
	Bit string concatenation.
x^y	Replication of bit value x into a y -bit string. x is always a single-bit value.
$x_{y:z}$	Selection of bits y through z of bit string x . Little-endian bit notation is always used. If y is less than z , this expression is an empty (zero length) bit string.
+	2's complement or floating-point addition.
-	2's complement or floating-point subtraction.
*	2's complement or floating-point multiplication.
div	2's complement integer division.
mod	2's complement modulo.
/	Floating-point division.
<	2's complement less than comparison.
and	Bit-wise logical AND.
or	Bit-wise logical OR.
xor	Bit-wise logical XOR.
nor	Bit-wise logical NOR.
GPR [x]	General-Register x . The content of GPR [0] is always zero. Attempts to alter the content of GPR [0] have no effect.
CPR [z, x]	Coprocessor unit z , general register x .
CCR [z, x]	Coprocessor unit z , control register x .
COC [z]	Coprocessor unit z condition signal.
BigEndianMem	Big-endian mode as configured at reset (0 -> Little, 1 -> Big). Specifies the endianness of the memory interface (see LoadMemory and StoreMemory), and the endianness of Kernel and Supervisor mode execution. However, this value is always 0 since the VR4102 supports the little endian order only.
ReverseEndian	Signal to reverse the endianness of load and store instructions. This feature is available in User mode only, and is effected by setting the RE bit of the Status register. Thus, ReverseEndian may be computed as (SR ₂₅ and User mode). However, this value is always 0 since the VR4102 supports the little endian order only.
BigEndianCPU	The endianness for load and store instructions (0 -> Little, 1 -> Big). In User mode, this endianness may be reversed by setting SR ₂₅ . Thus, BigEndianCPU may be computed as BigEndianMem XOR ReverseEndian. However, this value is always 0 since the VR4102 supports the little endian order only.
$T + i$	Indicates the time steps between operations. Each of the statements within a time step are defined to be executed in sequential order (as modified by conditional and loop constructs). Operations which are marked $T + i$ are executed at instruction cycle i relative to the start of execution of the instruction. Thus, an instruction which starts at time j executes operations marked $T + i$ at time $i + j$. The interpretation of the order of execution between two instructions or two operations which execute at the same time should be pessimistic; the order is not defined.

(1) Instruction notation examples

The following examples illustrate the application of some of the instruction notation conventions:

Example #1:

GPR [rt] <- immediate || 0¹⁶

Sixteen zero bits are concatenated with an immediate value (typically 16 bits), and the 32-bit string (with the lower 16 bits set to zero) is assigned to General-purpose register *rt*.

Example #2:

(immediate₁₅)¹⁶ || immediate_{15...0}

Bit 15 (the sign bit) of an immediate value is extended for 16 bit positions, and the result is concatenated with bits 15 through 0 of the immediate value to form a 32-bit sign extended value.

www.DataSheet4U.com

27.2 LOAD AND STORE INSTRUCTIONS

In the VR4102 implementation, the instruction immediately following a load may use the loaded contents of the register. In such cases, the hardware interlocks, requiring additional real cycles, so scheduling load delay slots is still desirable, although not required for functional code.

In the load and store descriptions, the functions listed in Table 27-2 are used to summarize the handling of virtual addresses and physical memory.

Table 27-2. Load and Store Common Functions

Function	Meaning
Address Translation	Uses the TLB to find the physical address given the virtual address. The function fails and an exception is taken if the required translation is not present in the TLB.
Load Memory	Uses the cache and main memory to find the contents of the word containing the specified physical address. The low-order three bits of the address and the Access Type field indicate which of each of the four bytes within the data word need to be returned. If the cache is enabled for this access, the entire word is returned and loaded into the cache.
Store Memory	Uses the cache, write buffer, and main memory to store the word or part of word specified as data in the word containing the specified physical address. The low-order three bits of the address and the Access Type field indicate which of each of the four bytes within the data word should be stored.

As shown in Table 27-3, the Access Type field indicates the size of the data item to be loaded or stored. Regardless of access type or byte-numbering order (endianness), the address specifies the byte which has the smallest byte address in the addressed field. This is the rightmost byte in the VR4102 since it supports the little-endian order only.

Table 27-3. Access Type Specifications for Loads/Stores

Access Type Mnemonic	Value	Meaning
DOUBLEWORD	7	8 bytes (64 bits)
SEPTIBYTE	6	7 bytes (56 bits)
SEXTIBYTE	5	6 bytes (48 bits)
QUINTIBYTE	4	5 bytes (40 bits)
WORD	3	4 bytes (32 bits)
TRIPLEBYTE	2	3 bytes (24 bits)
HALFWORD	1	2 bytes (16 bits)
BYTE	0	1 byte (8 bits)

The bytes within the addressed doubleword which are used can be determined directly from the access type and the three low-order bits of the address.

27.3 JUMP AND BRANCH INSTRUCTIONS

All jump and branch instructions have an architectural delay of exactly one instruction. That is, the instruction immediately following a jump or branch (that is, occupying the delay slot) is always executed while the target instruction is being fetched from storage. A delay slot may not itself be occupied by a jump or branch instruction; however, this error is not detected and the results of such an operation are undefined.

If an exception or interrupt prevents the completion of a legal instruction during a delay slot, the hardware sets the EPC register to point at the jump or branch instruction that precedes it. When the code is restarted, both the jump or branch instructions and the instruction in the delay slot are reexecuted.

Because jump and branch instructions may be restarted after exceptions or interrupts, they must be restartable. Therefore, when a jump or branch instruction stores a return link value, register *r31* (the register in which the link is stored) may not be used as a source register.

Since instructions must be word-aligned, a Jump Register or Jump and Link Register instruction must use a register which contains an address whose two low-order bits are zero. If these low-order bits are not zero, an address exception will occur when the jump target instruction is subsequently fetched.

27.4 SYSTEM CONTROL COPROCESSOR (CP0) INSTRUCTIONS

There are some special limitations imposed on operations involving CP0 that is incorporated within the CPU. Although load and store instructions to transfer data to/from coprocessors and to move control to/from coprocessor instructions are generally permitted by the MIPS architecture, CP0 is given a somewhat protected status since it has responsibility for exception handling and memory management. Therefore, the move to/from coprocessor instructions are the only valid mechanism for writing to and reading from the CP0 registers.

Several CP0 instructions are defined to directly read, write, and probe TLB entries and to modify the operating modes in preparation for returning to User mode or interrupt-enabled states.

27.5 CPU INSTRUCTION

This section describes the functions of CPU instructions in detail for both 32-bit mode and 64-bit mode. The exception that may occur by executing each instruction is shown in the last of each instruction's description. For details of exceptions and their processes, see Chapter 6.

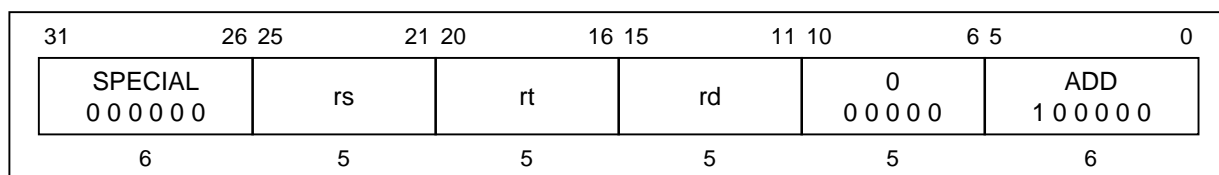
ADD**Add****ADD****Format:**

ADD rd, rs, rt

Description:

The contents of general register *rs* and the contents of general register *rt* are added to form the result. The result is placed into general register *rd*. In 64-bit mode, the operands must be valid sign-extended, 32-bit values.

An overflow exception occurs if the carries out of bits 30 and 31 differ (2's complement overflow). The destination register *rd* is not modified when an integer overflow exception occurs.

Operation:

32	T:	GPR [rd] <- GPR [rs] + GPR [rt]
64	T:	temp <- GPR [rs] + GPR [rt] GPR [rd] <- (temp ³²) ³² temp ^{31...0}

Exceptions:

Integer overflow exception

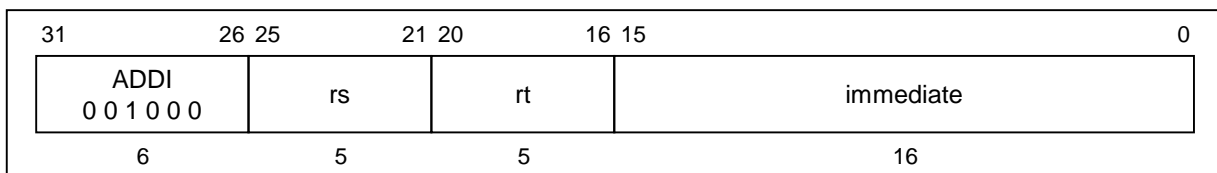
ADDI**Add Immediate****ADDI****Format:**

ADDI rt, rs, immediate

Description:

The 16-bit *immediate* is sign-extended and added to the contents of general register *rs* to form the result. The result is placed into general register *rt*. In 64-bit mode, the operand must be valid sign-extended, 32-bit values.

An overflow exception occurs if carries out of bits 30 and 31 differ (2's complement overflow). The destination register *rt* is not modified when an integer overflow exception occurs.

Operation:

32 T: $GPR[rt] \leftarrow GPR[rs] + (immediate_{15})^{16} \parallel immediate_{15..0}$

64 T: $temp \leftarrow GPR[rs] + (immediate_{15})^{48} \parallel immediate_{15..0}$
 $GPR[rt] \leftarrow (temp_{31})^{32} \parallel temp_{31..0}$

Exceptions:

Integer overflow exception

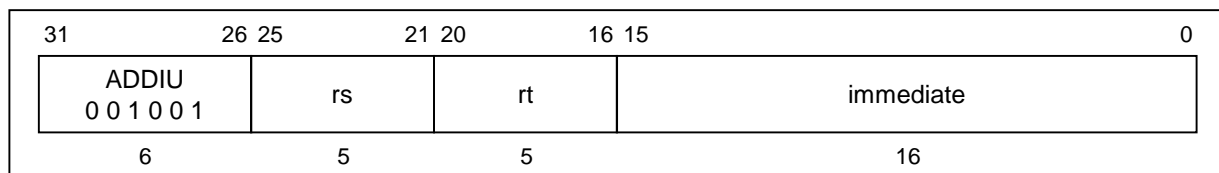
ADDIU**Add Immediate Unsigned****ADDIU****Format:**

ADDIU rt, rs, immediate

Description:

The 16-bit *immediate* is sign-extended and added to the contents of general register *rs* to form the result. The result is placed into general register *rt*. No integer overflow exception occurs under any circumstances. In 64-bit mode, the operand must be valid sign-extended, 32-bit values.

The only difference between this instruction and the ADDI instruction is that ADDIU never causes an integer overflow exception.

Operation:

32	T: GPR [rt] <- GPR [rs] + (immediate ₁₅) ¹⁶ immediate _{15...0}
64	T: temp <- GPR [rs] + (immediate ₁₅) ⁴⁸ immediate _{15...0} GPR [rt] <- (temp ₃₁) ³² temp _{31...0}

Exceptions:

None

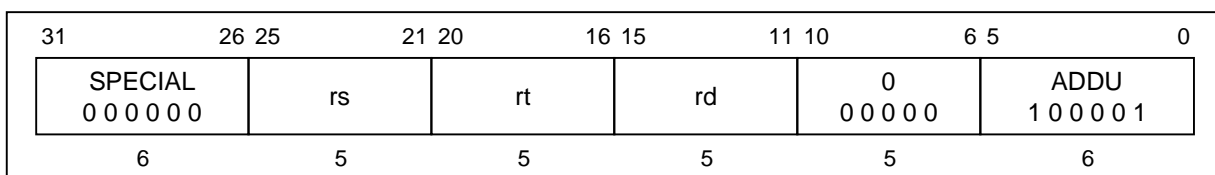
ADDU**Add Unsigned****ADDU****Format:**

ADDU rd, rs, rt

Description:

The contents of general register *rs* and the contents of general register *rt* are added to form the result. The result is placed into general register *rd*. No integer overflow exception occurs under any circumstances. In 64-bit mode, the operands must be valid sign-extended, 32-bit values.

The only difference between this instruction and the ADD instruction is that ADDU never causes an integer overflow exception.

Operation:

32	T:	GPR [rd] <- GPR [rs] + GPR [rt]
64	T:	temp <- GPR [rs] + GPR [rt] GPR [rd] <- (temp ³²) temp _{31...0}

Exceptions:

None

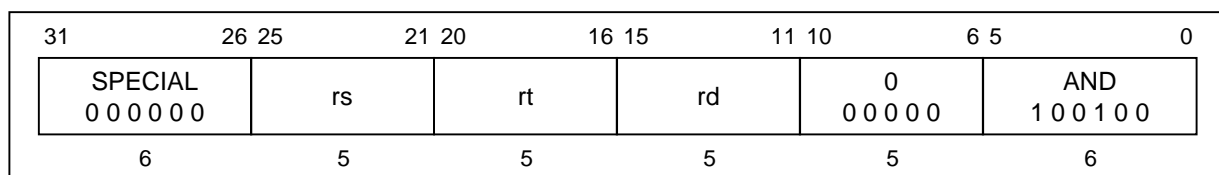
AND**And****AND****Format:**

AND rd, rs, rt

Description:

The contents of general register *rs* are combined with the contents of general register *rt* in a bit-wise logical AND operation. The result is placed into general register *rd*.

Operation:

32 T: GPR [rd] <- GPR [rs] and GPR [rt]

64 T: GPR [rd] <- GPR [rs] and GPR [rt]

Exceptions:

None

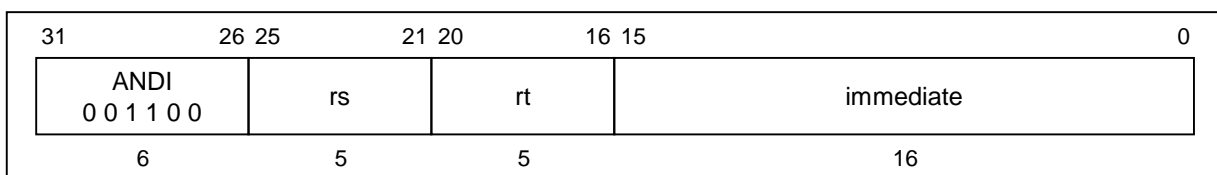
ANDI**And Immediate****ANDI****Format:**

ANDI rt, rs, immediate

Description:

The 16-bit *immediate* is zero-extended and combined with the contents of general register *rs* in a bit-wise logical AND operation. The result is placed into general register *rt*.

Operation:

32 T: GPR [rt] <- 0¹⁶ || (immediate and GPR [rs]_{15..0})

64 T: GPR [rt] <- 0⁴⁸ || (immediate and GPR [rs]_{15..0})

Exceptions:

None

BC0F Branch On Coprocessor 0 False BC0F

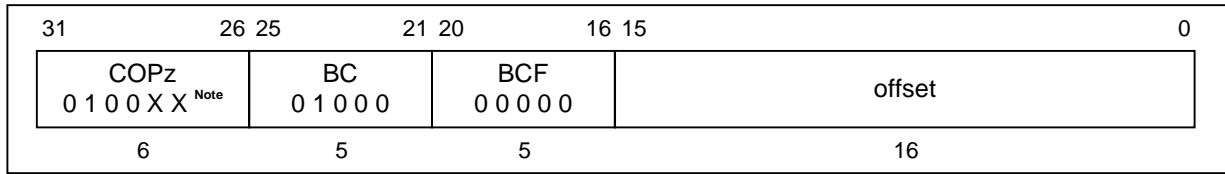

Format:

BC0F offset

Description:

A branch target address is computed from the sum of the address of the instruction in the delay slot and the 16-bit *offset*, shifted left two bits and sign-extended. If coprocessor 0's condition signal (CpCond: Status register bit-18 CH field), as sampled during the previous instruction, is false, then the program branches to the target address with a delay of one instruction.

Because the condition line is sampled during the previous instruction, there must be at least one instruction between this instruction and a coprocessor instruction that changes the condition line.

Operation:

```

32  T-1: condition <- not SR18
      T:  target <- (offset15)14 || offset || 02
      T+1: if condition then
            PC <- PC + target
          endif

64  T-1: condition <- not SR18
      T:  target <- (offset15)46 || offset || 02
      T+1: if condition then
            PC <- PC + target
          endif
    
```

Exceptions:

Coprocessor unusable exception

Note See the opcode table below, or **27.6 CPU INSTRUCTION OPCODE BIT ENCODING**.

Opcode Table:

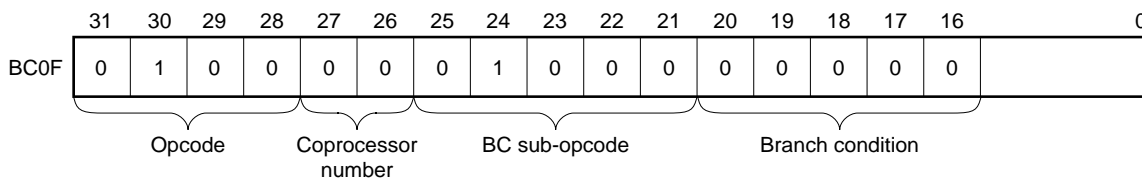

BC0FL Branch On Coprocessor 0 False Likely BC0FL

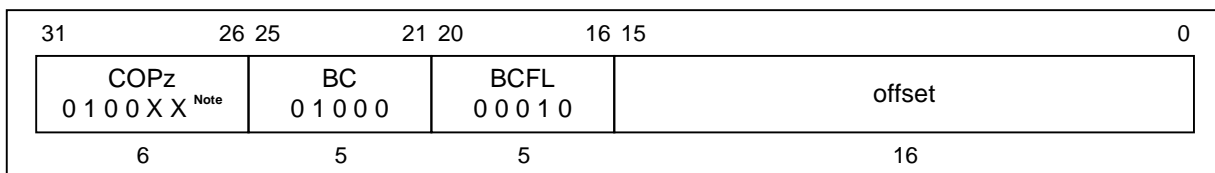

Format:

BC0FL offset

Description:

www.DataSheet4U.com

A branch target address is computed from the sum of the address of the instruction in the delay slot and the 16-bit *offset*, shifted left two bits and sign-extended. If the contents of coprocessor 0's condition line, as sampled during the previous instruction, is false, the target address is branched to with a delay of one instruction.

If the conditional branch is not taken, the instruction in the branch delay slot is nullified.

Because the condition line is sampled during the previous instruction, there must be at least one instruction between this instruction and a coprocessor instruction that changes the condition line.

Operation:

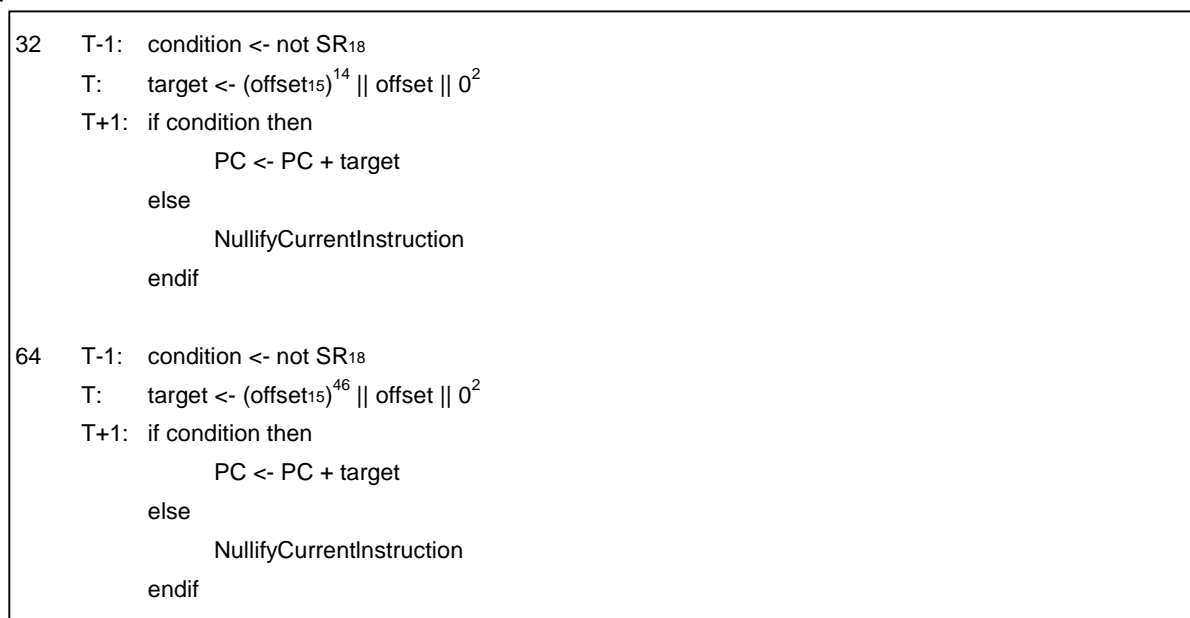

Exceptions:

Coprocessor unusable exception

Note See the opcode table below, or **27.6 CPU INSTRUCTION OPCODE BIT ENCODING**.

Opcode Table:

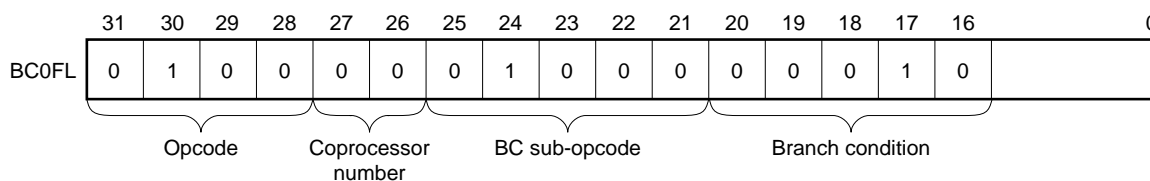

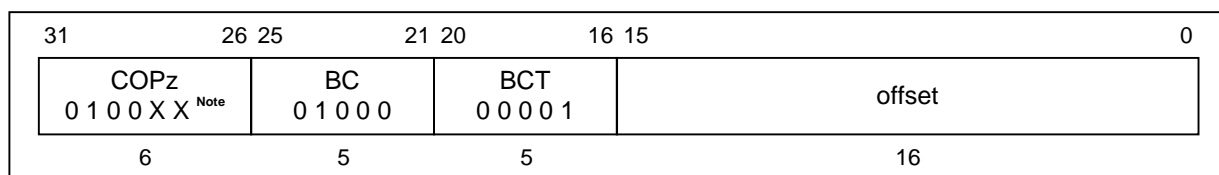
BC0T**Branch On Coprocessor 0 True****BC0T****Format:**

BC0T offset

Description:

A branch target address is computed from the sum of the address of the instruction in the delay slot and the 16-bit *offset*, shifted left two bits and sign-extended. If the coprocessor 0's condition signal (CpCond: Status register bit-18 CH field) is true, then the program branches to the target address, with a delay of one instruction.

Because the condition line is sampled during the previous instruction, there must be at least one instruction between this instruction and a coprocessor instruction that changes the condition line.

Operation:

```

32  T-1: condition <- SR18
    T:   target <- (offset15)14 || offset || 02
    T+1: if condition then
        PC <- PC + target
    endif

64  T-1: condition <- SR18
    T:   target <- (offset15)46 || offset || 02
    T+1: if condition then
        PC <- PC + target
    endif

```

Exceptions:

Coprocessor unusable exception

Note See the opcode table below, or **27.6 CPU INSTRUCTION OPCODE BIT ENCODING**.

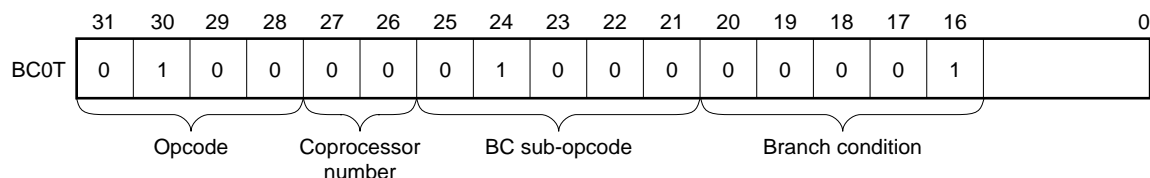
Opcode Table:

BC0TL Branch On Coprocessor 0 True Likely BC0TL

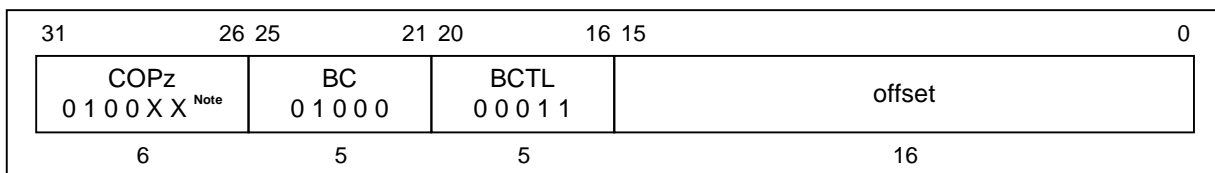

Format:

BC0TL offset

Description:

www.DataSheet4U.com

A branch target address is computed from the sum of the address of the instruction in the delay slot and the 16-bit *offset*, shifted left two bits and sign-extended. If the contents of coprocessor 0's condition line, as sampled during the previous instruction, is true, the target address is branched to with a delay of one instruction.

If the conditional branch is not taken, the instruction in the branch delay slot is nullified.

Because the condition line is sampled during the previous instruction, there must be at least one instruction between this instruction and a coprocessor instruction that changes the condition line.

Operation:

```

32  T-1: condition <- SR18
    T:   target <- (offset15)14 || offset || 02
    T+1: if condition then
        PC <- PC + target
    else
        NullifyCurrentInstruction
    endif

64  T-1: condition <- SR18
    T:   target <- (offset15)46 || offset || 02
    T+1: if condition then
        PC <- PC + target
    else
        NullifyCurrentInstruction
    endif
    
```

Exceptions:

Coprocessor unusable exception

Note See the opcode table below, or **27.6 CPU INSTRUCTION OPCODE BIT ENCODING**.

Opcode Table:

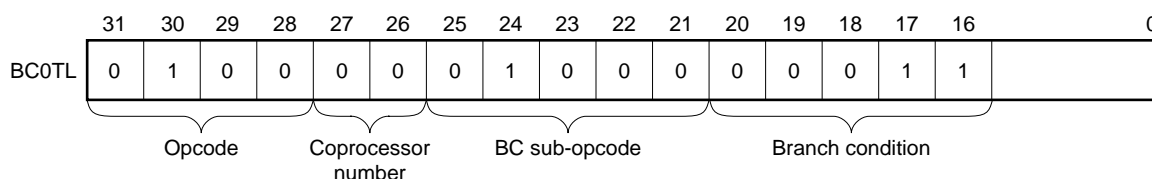

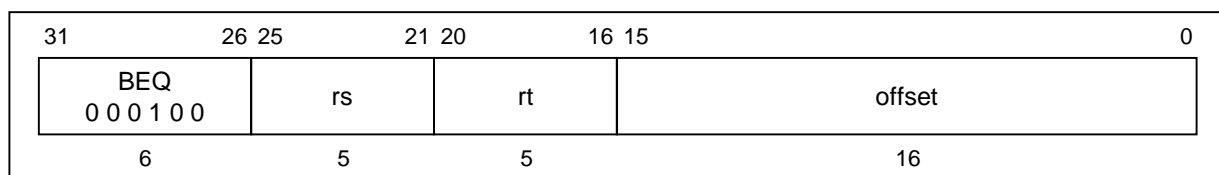
BEQ**Branch On Equal****BEQ****Format:**

BEQ rs, rt, offset

Description:

A branch target address is computed from the sum of the address of the instruction in the delay slot and the 16-bit *offset*, shifted left two bits and sign-extended. The contents of general register *rs* and the contents of general register *rt* are compared. If the two registers are equal, then the program branches to the target address, with a delay of one instruction.

Operation:

```

32  T:  target <- (offset15)14 || offset || 02
      condition <- (GPR [rs] = GPR [rt])
      T+1: if condition then
            PC <- PC + target
          endif

64  T:  target <- (offset15)46 || offset || 02
      condition <- (GPR [rs] = GPR [rt])
      T+1: if condition then
            PC <- PC + target
          endif

```

Exceptions:

None

BEQL

Branch On Equal Likely

BEQL

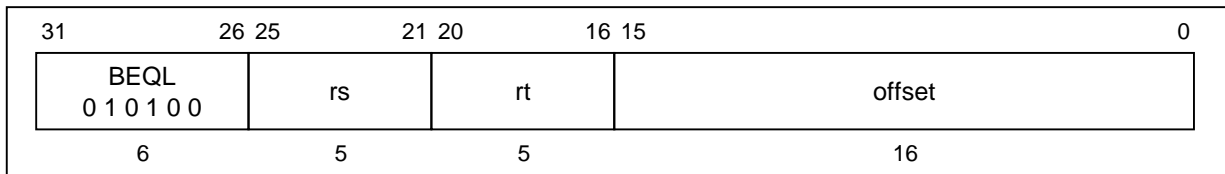

Format:

BEQL rs, rt, offset

Description:

A branch target address is computed from the sum of the address of the instruction in the delay slot and the 16-bit offset, shifted left two bits and sign-extended. The contents of general register *rs* and the contents of general register *rt* are compared. If the two registers are equal, the target address is branched to, with a delay of one instruction. If the conditional branch is not taken, the instruction in the branch delay slot is nullified.

Operation:

```

32  T:  target <- (offset15)14 || offset || 02
       condition <- (GPR [rs] = GPR [rt])
       T+1: if condition then
             PC <- PC + target
           else
             NullifyCurrentInstruction
           endif

64  T:  target <- (offset15)46 || offset || 02
       condition <- (GPR [rs] = GPR [rt])
       T+1: if condition then
             PC <- PC + target
           else
             NullifyCurrentInstruction
           endif
    
```

Exceptions:

None

BGEZ Branch On Greater Than Or Equal To Zero BGEZ

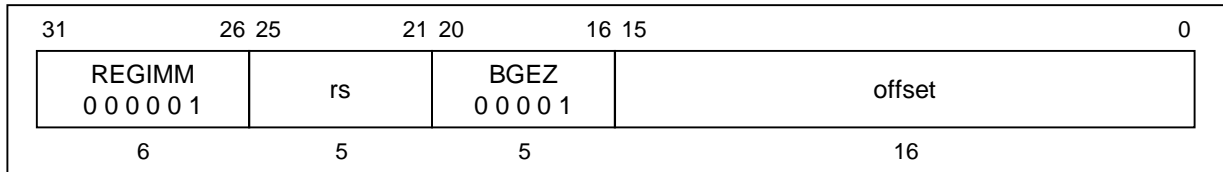
**Format:**

BGEZ rs, offset

Description:

A branch target address is computed from the sum of the address of the instruction in the delay slot and the 16-bit *offset*, shifted left two bits and sign-extended. If the contents of general register *rs* have the sign bit cleared, then the program branches to the target address, with a delay of one instruction.

Operation:

32	T: target \leftarrow (offset ₁₅) ¹⁴ offset 0 ² condition \leftarrow (GPR [rs] ₃₁ = 0) T+1: if condition then PC \leftarrow PC + target endif
64	T: target \leftarrow (offset ₁₅) ⁴⁶ offset 0 ² condition \leftarrow (GPR [rs] ₆₃ = 0) T+1: if condition then PC \leftarrow PC + target endif

Exceptions:

None

BGEZAL Branch On Greater Than Or Equal To Zero And Link BGEZAL

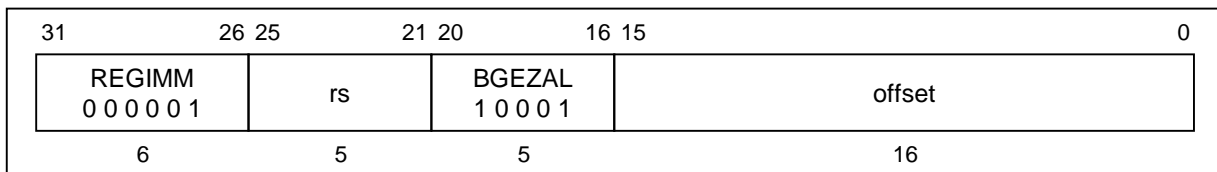
**Format:**

BGEZAL rs, offset

Description:

A branch target address is computed from the sum of the address of the instruction in the delay slot and the 16-bit *offset*, shifted left two bits and sign-extended. Unconditionally, the address of the instruction after the delay slot is placed in the link register, *r31*. If the contents of general register *rs* have the sign bit cleared, then the program branches to the target address, with a delay of one instruction.

General register *rs* may not be general register *r31*, because such an instruction is not restartable. An attempt to execute this instruction is not trapped, however.

Operation:

```

32  T:  target <- (offset15)14 || offset || 02
      condition <- (GPR [rs]31 = 0)
      GPR [31] <- PC + 8
      T+1: if condition then
            PC <- PC + target
      endif

64  T:  target <- (offset15)46 || offset || 02
      condition <- (GPR [rs]63 = 0)
      GPR [31] <- PC + 8
      T+1: if condition then
            PC <- PC + target
      endif

```

Exceptions:

None

BGEZALL Branch On Greater Than Or Equal To Zero And Link Likely BGEZALL

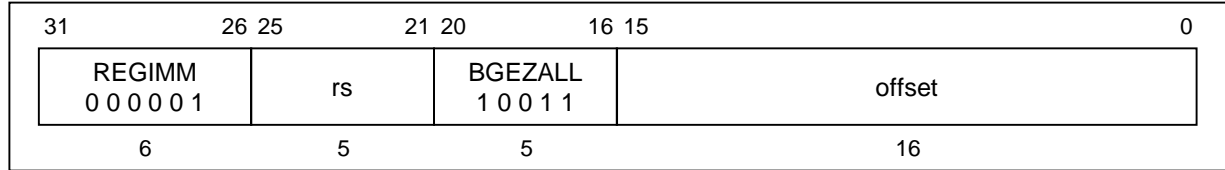
**Format:**

BGEZALL rs, offset

Description:

A branch target address is computed from the sum of the address of the instruction in the delay slot and the 16-bit *offset*, shifted left two bits and sign-extended. Unconditionally, the address of the instruction after the delay slot is placed in the link register, *r31*. If the contents of general register *rs* have the sign bit cleared, then the program branches to the target address, with a delay of one instruction. General register *rs* may not be general register 31, because such an instruction is not restartable. An attempt to execute this instruction is not trapped, however. If the conditional branch is not taken, the instruction in the branch delay slot is nullified.

Operation:

```

32  T:  target <- (offset15)14 || offset || 02
      condition <- (GPR [rs]31 = 0)
      GPR [31] <- PC + 8
      T+1: if condition then
            PC <- PC + target
          else
            NullifyCurrentInstruction
          endif

64  T:  target <- (offset15)46 || offset || 02
      condition <- (GPR [rs]63 = 0)
      GPR [31] <- PC + 8
      T+1: if condition then
            PC <- PC + target
          else
            NullifyCurrentInstruction
          endif

```

Exceptions:

None

BGEZL Branch On Greater Than Or Equal To Zero Likely BGEZL

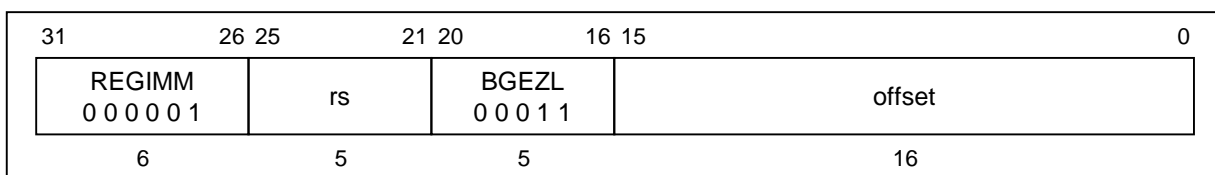

Format:

BGEZL rs, offset

Description:

A branch target address is computed from the sum of the address of the instruction in the delay slot and the 16-bit *offset*, shifted left two bits and sign-extended. If the contents of general register *rs* have the sign bit cleared, then the program branches to the target address, with a delay of one instruction. If the conditional branch is not taken, the instruction in the branch delay slot is nullified.

Operation:

```

32  T:  target <- (offset15)14 || offset || 02
      condition <- (GPR [rs]31 = 0)
      T+1: if condition then
            PC <- PC + target
          else
            NullifyCurrentInstruction
          endif

64  T:  target <- (offset15)46 || offset || 02
      condition <- (GPR [rs]63 = 0)
      T+1: if condition then
            PC <- PC + target
          else
            NullifyCurrentInstruction
          endif

```

Exceptions:

None

BGTZ Branch On Greater Than Zero BGTZ

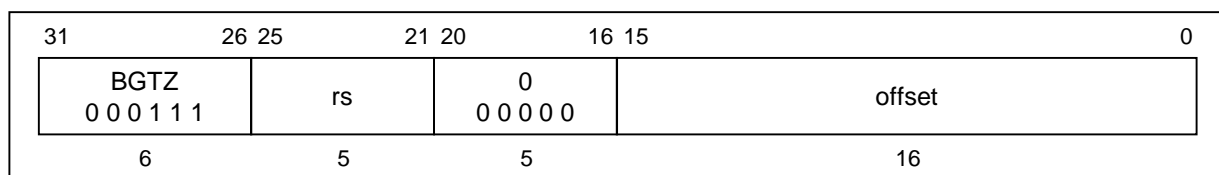
**Format:**

BGTZ rs, offset

Description:

www.DataSheet4U.com

A branch target address is computed from the sum of the address of the instruction in the delay slot and the 16-bit *offset*, shifted left two bits and sign-extended. The contents of general register *rs* are compared to zero. If the contents of general register *rs* have the sign bit cleared and are not equal to zero, then the program branches to the target address, with a delay of one instruction.

Operation:

```

32  T:  target <- (offset15)14 || offset || 02
      condition <- (GPR [rs]31 = 0) and (GPR [rs] ≠ 032)
      T+1: if condition then
            PC <- PC + target
          endif

64  T:  target <- (offset15)46 || offset || 02
      condition <- (GPR [rs]63 = 0) and (GPR [rs] ≠ 064)
      T+1: if condition then
            PC <- PC + target
          endif

```

Exceptions:

None

BGTZL Branch On Greater Than Zero Likely BGTZL

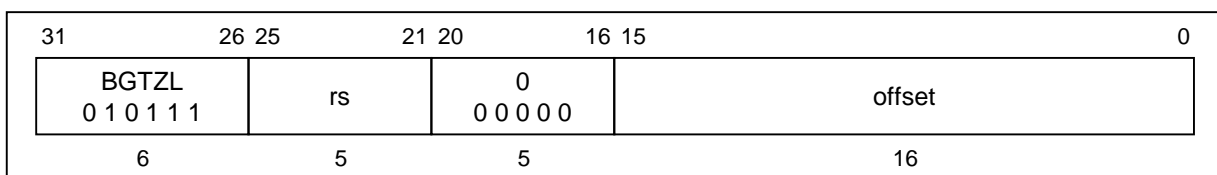
**Format:**

BGTZL rs, offset

Description:

A branch target address is computed from the sum of the address of the instruction in the delay slot and the 16-bit *offset*, shifted left two bits and sign-extended. The contents of general register *rs* are compared to zero. If the contents of general register *rs* have the sign bit cleared and are not equal to zero, then the program branches to the target address, with a delay of one instruction. If the conditional branch is not taken, the instruction in the branch delay slot is nullified.

Operation:

```

32  T:  target <- (offset15)14 || offset || 02
      condition <- (GPR [rs]31 = 0) and (GPR [rs] ≠ 032)
      T+1: if condition then
            PC <- PC + target
          else
            NullifyCurrentInstruction
          endif

64  T:  target <- (offset15)46 || offset || 02
      condition <- (GPR [rs]63 = 0) and (GPR [rs] ≠ 064)
      T+1: if condition then
            PC <- PC + target
          else
            NullifyCurrentInstruction
          endif

```

Exceptions:

None

BLEZ Branch On Less Than Or Equal To Zero BLEZ

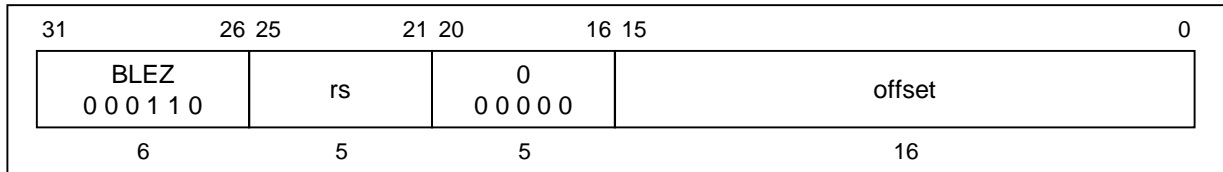
**Format:**

BLEZ rs, offset

Description:

A branch target address is computed from the sum of the address of the instruction in the delay slot and the 16-bit *offset*, shifted left two bits and sign-extended. The contents of general register *rs* are compared to zero. If the contents of general register *rs* have the sign bit set, or are equal to zero, then the program branches to the target address, with a delay of one instruction.

Operation:

```

32  T:  target <- (offset15)14 || offset || 02
      condition <- (GPR [rs]31 = 1) or (GPR [rs] = 032)
      T+1: if condition then
            PC <- PC + target
          endif

64  T:  target <- (offset15)46 || offset || 02
      condition <- (GPR [rs]63 = 1) or (GPR [rs] = 064)
      T+1: if condition then
            PC <- PC + target
          endif

```

Exceptions:

None

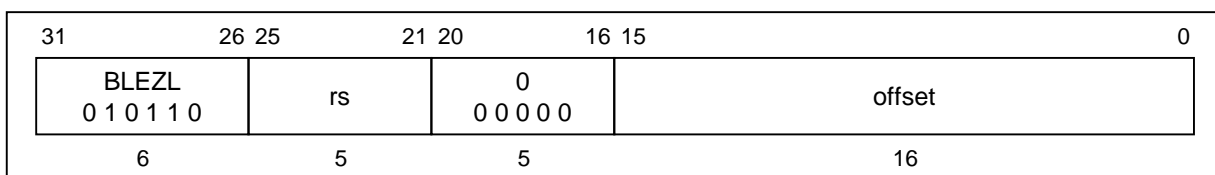
BLEZL Branch On Less Than Or Equal To Zero Likely **BLEZL****Format:**

BLEZL rs, offset

Description:

A branch target address is computed from the sum of the address of the instruction in the delay slot and the 16-bit *offset*, shifted left two bits and sign-extended. The contents of general register *rs* is compared to zero. If the contents of general register *rs* have the sign bit set, or are equal to zero, then the program branches to the target address, with a delay of one instruction.

If the conditional branch is not taken, the instruction in the branch delay slot is nullified.

Operation:

```

32  T:  target <- (offset15)14 || offset || 02
      condition <- (GPR [rs]31 = 1) or (GPR [rs] = 032)
      T+1: if condition then
            PC <- PC + target
          else
            NullifyCurrentInstruction
          endif

64  T:  target <- (offset15)46 || offset || 02
      condition <- (GPR [rs]63 = 1) or (GPR [rs] = 064)
      T+1: if condition then
            PC <- PC + target
          else
            NullifyCurrentInstruction
          endif

```

Exceptions:

None

BLTZAL Branch On Less Than Zero And Link BLTZAL

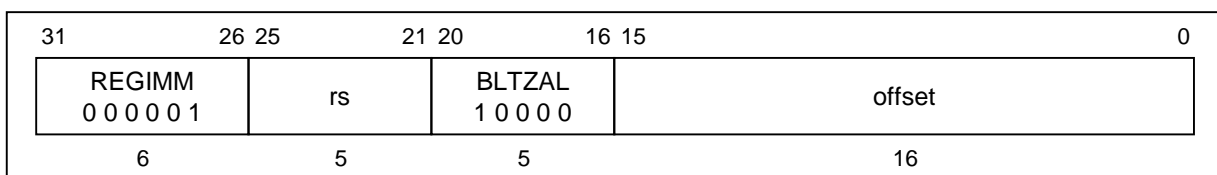
**Format:**

BLTZAL rs, offset

Description:

A branch target address is computed from the sum of the address of the instruction in the delay slot and the 16-bit *offset*, shifted left two bits and sign-extended. Unconditionally, the address of the instruction after the delay slot is placed in the link register, *r31*. If the contents of general register *rs* have the sign bit set, then the program branches to the target address, with a delay of one instruction.

General register *rs* may not be general register *31*, because such an instruction is not restartable. An attempt to execute this instruction with register *31* specified as *rs* is not trapped, however.

Operation:

```

32  T:  target <- (offset15)14 || offset || 02
      condition <- (GPR [rs]31 = 1)
      GPR [31] <- PC + 8
      T+1: if condition then
            PC <- PC + target
          endif

64  T:  target <- (offset15)46 || offset || 02
      condition <- (GPR [rs]63 = 1)
      GPR [31] <- PC + 8
      T+1: if condition then
            PC <- PC + target
          endif

```

Exceptions:

None

BLTZALL Branch On Less Than Zero And Link Likely BLTZALL

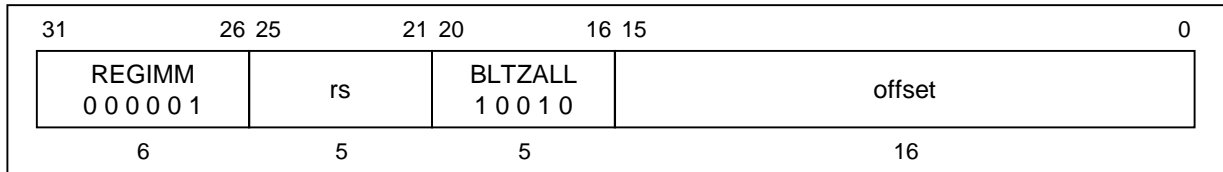
**Format:**

BLTZALL rs, offset

Description:

A branch target address is computed from the sum of the address of the instruction in the delay slot and the 16-bit *offset*, shifted left two bits and sign-extended. Unconditionally, the address of the instruction after the delay slot is placed in the link register, *r31*. If the contents of general register *rs* have the sign bit set, then the program branches to the target address, with a delay of one instruction.

General register *rs* may not be general register *31*, because such an instruction is not restartable. An attempt to execute this instruction with register *31* specified as *rs* is not trapped, however. If the conditional branch is not taken, the instruction in the branch delay slot is nullified.

Operation:

```

32  T:  target <- (offset15)14 || offset || 02
      condition <- (GPR [rs]31 = 1)
      GPR [31] <- PC + 8
      T+1: if condition then
            PC <- PC + target
          else
            NullifyCurrentInstruction
          endif

64  T:  target <- (offset15)46 || offset || 02
      condition <- (GPR [rs]63 = 1)
      GPR [31] <- PC + 8
      T+1: if condition then
            PC <- PC + target
          else
            NullifyCurrentInstruction
          endif

```

Exceptions:

None

BLTZL Branch On Less Than Zero Likely BLTZL

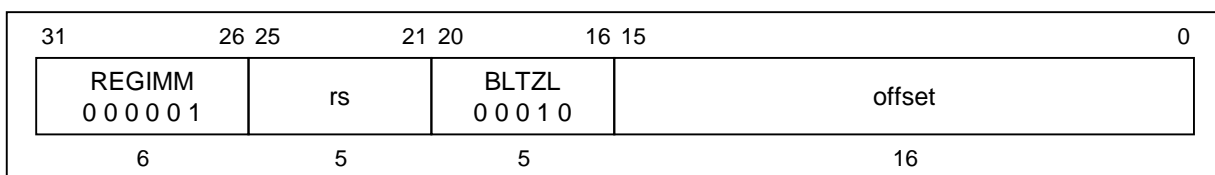
**Format:**

BLTZ rs, offset

Description:

A branch target address is computed from the sum of the address of the instruction in the delay slot and the 16-bit *offset*, shifted left two bits and sign-extended. If the contents of general register *rs* have the sign bit set, then the program branches to the target address, with a delay of one instruction. If the conditional branch is not taken, the instruction in the branch delay slot is nullified.

Operation:

```

32  T:  target <- (offset15)14 || offset || 02
      condition <- (GPR [rs]31 = 1)
      T+1: if condition then
            PC <- PC + target
          else
            NullifyCurrentInstruction
          endif

64  T:  target <- (offset15)46 || offset || 02
      condition <- (GPR [rs]63 = 1)
      T+1: if condition then
            PC <- PC + target
          else
            NullifyCurrentInstruction
          endif

```

Exceptions:

None

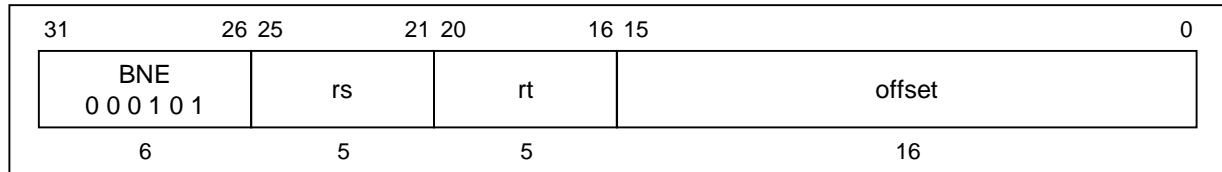
BNE**Branch On Not Equal****BNE****Format:**

BNE rs, rt, offset

Description:

A branch target address is computed from the sum of the address of the instruction in the delay slot and the 16-bit *offset*, shifted left two bits and sign-extended. The contents of general register *rs* and the contents of general register *rt* are compared. If the two registers are not equal, then the program branches to the target address, with a delay of one instruction.

Operation:

```

32  T:  target <- (offset15)14 || offset || 02
      condition <- (GPR [rs] ≠ GPR [rt])
      T+1: if condition then
            PC <- PC + target
          endif

64  T:  target <- (offset15)46 || offset || 02
      condition <- (GPR [rs] ≠ GPR [rt])
      T+1: if condition then
            PC <- PC + target
          endif

```

Exceptions:

None

BNEL Branch On Not Equal Likely BNEL

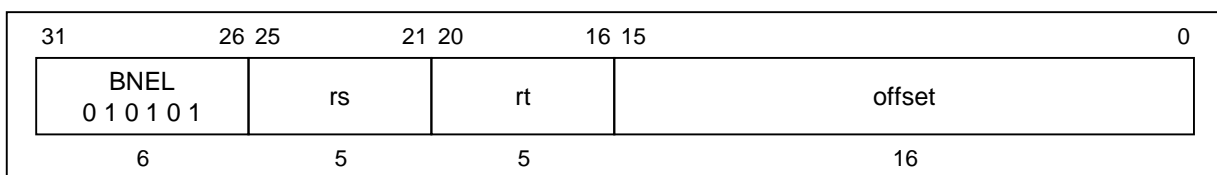
**Format:**

BNEL rs, rt, offset

Description:

A branch target address is computed from the sum of the address of the instruction in the delay slot and the 16-bit *offset*, shifted left two bits and sign-extended. The contents of general register *rs* and the contents of general register *rt* are compared. If the two registers are not equal, then the program branches to the target address, with a delay of one instruction.

If the conditional branch is not taken, the instruction in the branch delay slot is nullified.

Operation:

```

32  T:  target <- (offset15)14 || offset || 02
      condition <- (GPR [rs] ≠ GPR [rt])
      T+1: if condition then
            PC <- PC + target
          else
            NullifyCurrentInstruction
          endif

64  T:  target <- (offset15)46 || offset || 02
      condition <- (GPR [rs] ≠ GPR [rt])
      T+1: if condition then
            PC <- PC + target
          else
            NullifyCurrentInstruction
          endif

```

Exceptions:

None

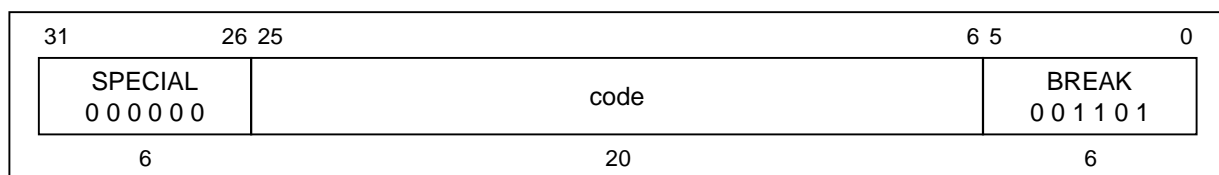
BREAK**Breakpoint****BREAK****Format:**

BREAK

Description:

A breakpoint trap occurs, immediately and unconditionally transferring control to the exception handler.

The code field is available for use as software parameters, but is retrieved by the exception handler only by loading the contents of the memory word containing the instruction.

Operation:

32,64 T: BreakpointException

Exceptions:

Breakpoint exception

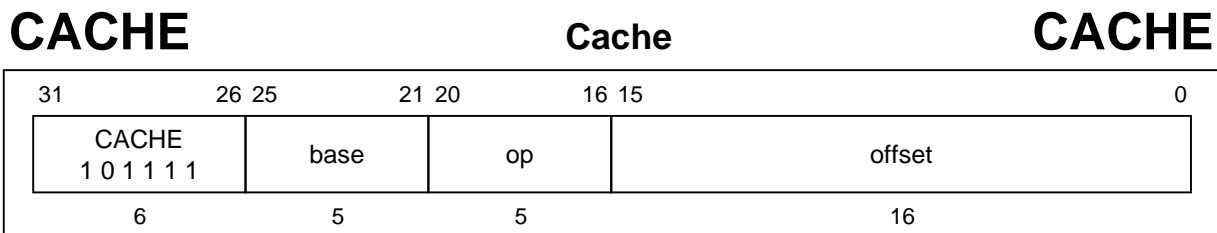
**Format:**

CACHE op, offset (base)

Description:

The 16-bit *offset* is sign-extended and added to the contents of general register *base* to form a virtual address. The virtual address is translated to a physical address using the TLB, and the 5-bit sub-opcode specifies a cache operation for that address.

If CP0 is not usable (User or Supervisor mode) and the CP0 enable bit in the Status register is clear, a coprocessor unusable exception is taken. The operation of this instruction on any operation/cache combination not listed below, or on a secondary cache, is undefined. The operation of this instruction on uncached addresses is also undefined.

The Index operation uses part of the virtual address to specify a cache block.

For a primary cache of $2^{\text{CACHEBITS}}$ bytes with 2^{LINEBITS} bytes per tag, $\text{vAddr}_{\text{CACHEBITS} \dots \text{LINEBITS}}$ specifies the block.

Index Load Tag also uses $\text{vAddr}_{\text{LINEBITS} \dots 3}$ to select the doubleword for reading parity. When the *CE* bit of the Status register is set, Fill Cache op uses the PErr register to store parity values into the cache.

The Hit operation accesses the specified cache as normal data references, and performs the specified operation if the cache block contains valid data with the specified physical address (a hit). If the cache block is invalid or contains a different address (a miss), no operation is performed.

CACHE**Cache
(Continued)****CACHE**

Write back from a primary cache goes to memory. The address to be written is specified by the cache tag and not the translated physical address.

TLB Refill and TLB Invalid exceptions can occur on any operation. For Index operations (where the physical address is used to index the cache but need not match the cache tag) unmapped addresses may be used to avoid TLB exceptions. This operation never causes a TLB Modified exception.

Bits 17...16 of the instruction specify the cache as follows:

Code	Name	Cache
0	I	Primary instruction
1	D	Primary data
2, 3	NA	Reserved (undefined)

CACHE

Cache
(Continued)

CACHE

Bits 20...18 (this value is listed under the **Code** column) of the instruction specify the operation as follows:

Code	Cache	Name	Operation
0	I	Index_Invalidate	Set the cache state of the cache block to Invalid.
0	D	Index_Write_Back Invalidate	Examine the cache state and W bit of the primary data cache block at the index specified by the virtual address. If the state is not Invalid and the W bit is set, then write back the block to memory. The address to write is taken from the primary cache tag. Set cache state of primary cache block to Invalid.
1	I, D	Index_Load_Tag	Read the tag for the cache block at the specified index and place it into the TagLo CP0 registers, ignoring parity errors. Also load the data parity bits into the ECC register.
2	I, D	Index_Store_Tag	Write the tag for the cache block at the specified index from the TagLo and TagHi CP0 registers.
3	D	Create_Dirty_ Exclusive	This operation is used to avoid loading data needlessly from memory when writing new contents into an entire cache block. If the cache block does not contain the specified address, and the block is dirty, write it back to the memory. In all cases, set the cache state to Dirty.
4	I, D	Hit_Invalidate	If the cache block contains the specified address, mark the cache block invalid.
5	D	Hit_Write_Back Invalidate	If the cache block contains the specified address, write back the data if it is dirty, and mark the cache block invalid.
5	I	Fill	Fill the primary instruction cache block from memory. If the CE bit of the Status register is set, the contents of the ECC register is used instead of the computed parity bits for addressed doubleword when written to the instruction cache.
6	D	Hit_Write_Back	If the cache block contains the specified address and the W bit is set, write back the data to memory and clear the W bit.
6	I	Hit_Write_Back	If the cache block contains the specified address, write back the data unconditionally.

CACHE**Cache
(Continued)****CACHE****Operation:**

```
32, 64 T:  vAddr <- ((offset15)48 || offset15...0) + GPR [base]
           (pAddr, uncached) <- AddressTranslation (vAddr, DATA)
           CacheOp (op, vAddr, pAddr)
```

Exceptions:

Coprocessor unusable exception
TLB Refill exception
TLB Invalid exception
Bus Error exception
Address Error exception
Cache Error exception

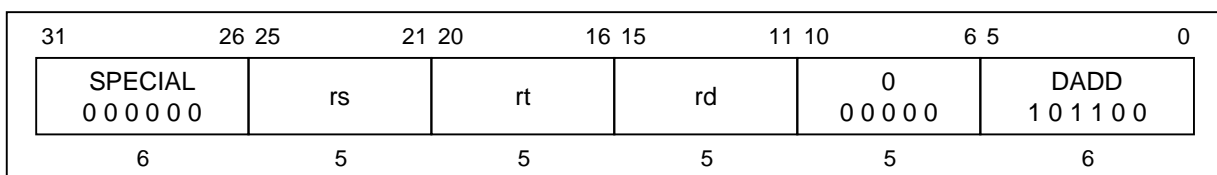
DADD**Doubleword Add****DADD****Format:**

DADD rd, rs, rt

Description:

The contents of general register *rs* and the contents of general register *rt* are added to form the result. The result is placed into general register *rd*.

An overflow exception occurs if the carries out of bits 62 and 63 differ (2's complement overflow). The destination register *rd* is not modified when an integer overflow exception occurs.

This operation is only defined for the VR4102 operating in 64-bit mode. Execution of this instruction in 32-bit user or supervisor mode causes a reserved instruction exception.

Operation:

64 T: GPR [rd] <- GPR [rs] + GPR [rt]

Exceptions:

Integer overflow exception

Reserved instruction exception (VR4102 in 32-bit user mode, VR4102 in 32-bit supervisor mode)

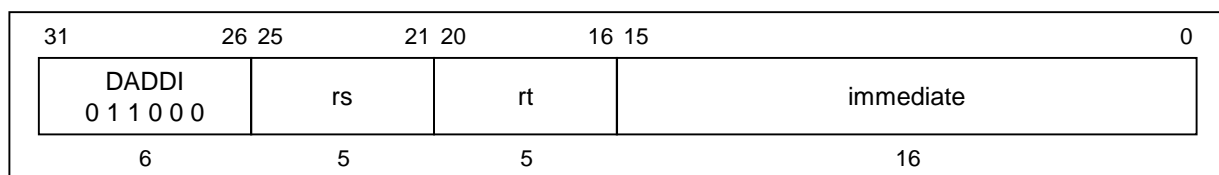
DADDI**Doubleword Add Immediate****DADDI****Format:**

DADDI rt, rs, immediate

Description:

The 16-bit *immediate* is sign-extended and added to the contents of general register *rs* to form the result. The result is placed into general register *rt*.

An overflow exception occurs if carries out of bits 62 and 63 differ (2's complement overflow). The destination register *rt* is not modified when an integer overflow exception occurs.

This operation is only defined for the VR4102 operating in 64-bit mode. Execution of this instruction in 32-bit user or supervisor mode causes a reserved instruction exception.

Operation:

64 T: $\text{GPR}[rt] \leftarrow \text{GPR}[rs] + (\text{immediate}_{15})^{48} \parallel \text{immediate}_{15..0}$

Exceptions:

Integer overflow exception

Reserved instruction exception (VR4102 in 32-bit user mode, VR4102 in 32-bit supervisor mode)

DADDIU Doubleword Add Immediate Unsigned DADDIU

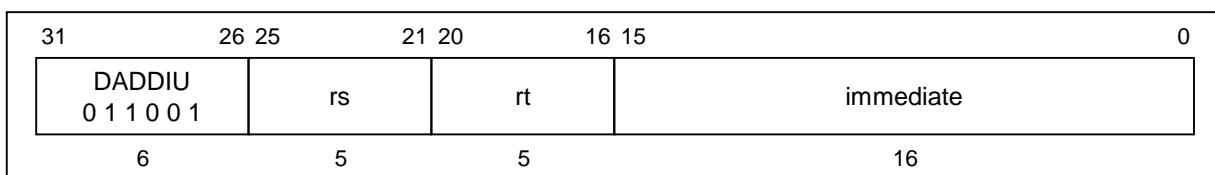
**Format:**

DADDIU rt, rs, immediate

Description:

The 16-bit *immediate* is sign-extended and added to the contents of general register *rs* to form the result. The result is placed into general register *rt*. No integer overflow exception occurs under any circumstances.

The only difference between this instruction and the DADDI instruction is that DADDIU never causes an overflow exception.

This operation is only defined for the VR4102 operating in 64-bit mode. Execution of this instruction in 32-bit user or supervisor mode causes a reserved instruction exception.

Operation:

$$64 \quad T: \quad \text{GPR [rt]} \leftarrow \text{GPR [rs]} + (\text{immediate}_{15})^{48} \parallel \text{immediate}_{15..0}$$
Exceptions:

Reserved instruction exception (VR4102 in 32-bit user mode, VR4102 in 32-bit supervisor mode)

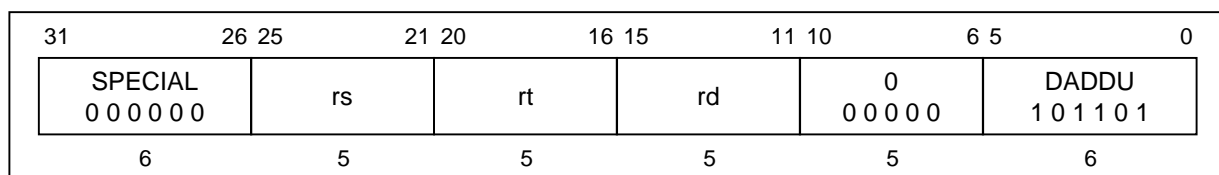
DADDU**Doubleword Add Unsigned****DADDU****Format:**

DADDU rd, rs, rt

Description:

The contents of general register *rs* and the contents of general register *rt* are added to form the result. The result is placed into general register *rd*.

No overflow exception occurs under any circumstances.

The only difference between this instruction and the DADD instruction is that DADDU never causes an overflow exception.

This operation is only defined for the VR4102 operating in 64-bit mode. Execution of this instruction in 32-bit user or supervisor mode causes a reserved instruction exception.

Operation:

64 T: GPR [rd] <- GPR [rs] + GPR [rt]

Exceptions:

Reserved instruction exception (VR4102 in 32-bit user mode, VR4102 in 32-bit supervisor mode)

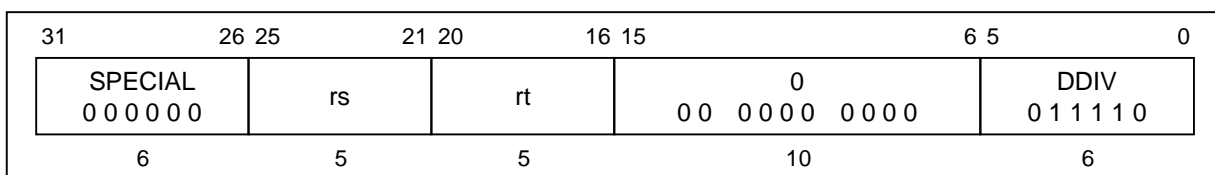
DDIV**Doubleword Divide****DDIV****Format:**

DDIV rs, rt

Description:

The contents of general register *rs* are divided by the contents of general register *rt*, treating both operands as 2's complement values. No overflow exception occurs under any circumstances, and the result of this operation is undefined when the divisor is zero.

This instruction is typically followed by additional instructions to check for a zero divisor and for overflow.

When the operation completes, the quotient word of the double result is loaded into special register *LO*, and the remainder word of the double result is loaded into special register *HI*.

If either of the two preceding instructions is MFHI or MFLO, the results of those instructions are undefined. Correct operation requires separating reads of *HI* or *LO* from writes by two or more instructions. This is defined in this manner to take account of the VR4000™ hazards (for code compatibility) as well as the VR4100's own hazards.

This operation is only defined for the VR4102 operating in 64-bit mode. Execution of this instruction in 32-bit user or supervisor mode causes a reserved instruction exception.

Operation:

64	T-2:	LO	<- undefined
		HI	<- undefined
	T-1:	LO	<- undefined
		HI	<- undefined
	T:	LO	<- GPR [rs] div GPR [rt]
		HI	<- GPR [rs] mod GPR [rt]

Exceptions:

Reserved instruction exception (VR4102 in 32-bit user mode, VR4102 in 32-bit supervisor mode)

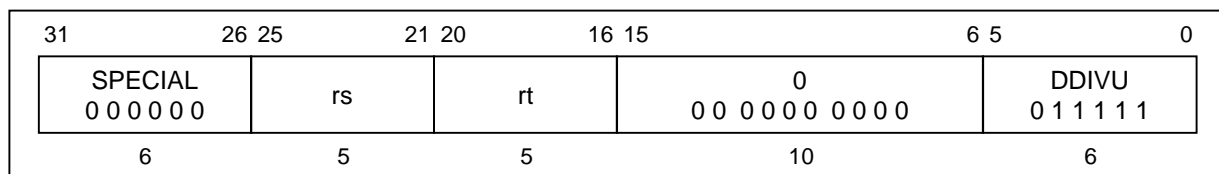
DDIVU**Doubleword Divide Unsigned****DDIVU****Format:**

DDIVU rs, rt

Description:

The contents of general register *rs* are divided by the contents of general register *rt*, treating both operands as unsigned values. No integer overflow exception occurs under any circumstances, and the result of this operation is undefined when the divisor is zero.

This instruction may be followed by additional instructions to check for a zero divisor, inserted by the programmer.

When the operation completes, the quotient word of the double result is loaded into special register *LO*, and the remainder word of the double result is loaded into special register *HI*.

If either of the two preceding instructions is MFHI or MFLO, the results of those instructions are undefined. Correct operation requires separating reads of *HI* or *LO* from writes by two or more instructions.

This operation is only defined for the VR4102 operating in 64-bit mode. Execution of this instruction in 32-bit user or supervisor mode causes a reserved instruction exception.

Operation:

64	T-2:	LO <- undefined
		HI <- undefined
	T-1:	LO <- undefined
		HI <- undefined
	T:	LO <- (0 GPR [rs]) div (0 GPR [rt])
		HI <- (0 GPR [rs]) mod (0 GPR [rt])

Exceptions:

Reserved instruction exception (VR4102 in 32-bit user mode, VR4102 in 32-bit supervisor mode)

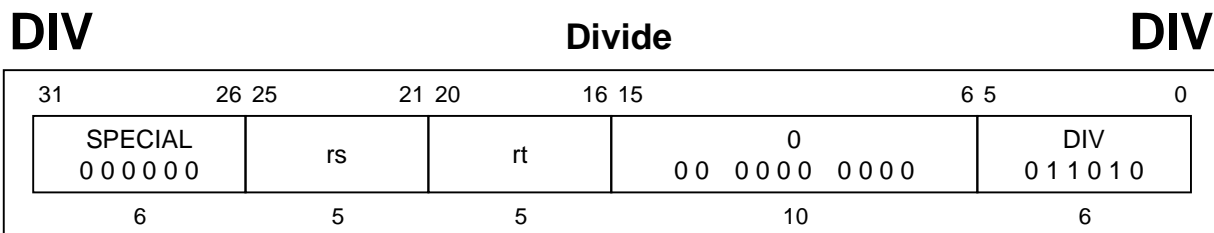
**Format:**

DIV rs, rt

Description:

The contents of general register *rs* are divided by the contents of general register *rt*, treating both operands as 2's complement values. No overflow exception occurs under any circumstances, and the result of this operation is undefined when the divisor is zero.

In 64-bit mode, the operands must be valid sign-extended, 32-bit values.

This instruction is typically followed by additional instructions to check for a zero divisor and for overflow.

When the operation completes, the quotient word of the double result is loaded into special register *LO*, and the remainder word of the double result is loaded into special register *HI*.

If either of the two preceding instructions is MFHI or MFLO, the results of those instructions are undefined. Correct operation requires separating reads of *HI* or *LO* from writes by two or more instructions.

Operation:

32	T-2:	LO	<-	undefined
		HI	<-	undefined
	T-1:	LO	<-	undefined
		HI	<-	undefined
	T:	LO	<-	GPR [rs] div GPR [rt]
		HI	<-	GPR [rs] mod GPR [rt]
64	T-2:	LO	<-	undefined
		HI	<-	undefined
	T-1:	LO	<-	undefined
		HI	<-	undefined
	T:	q	<-	GPR [rs] _{31..0} div GPR [rt] _{31..0}
		r	<-	GPR [rs] _{31..0} mod GPR [rt] _{31..0}
		LO	<-	$(q_{31})^{32} q_{31..0}$
		HI	<-	$(r_{31})^{32} r_{31..0}$

Exceptions:

None

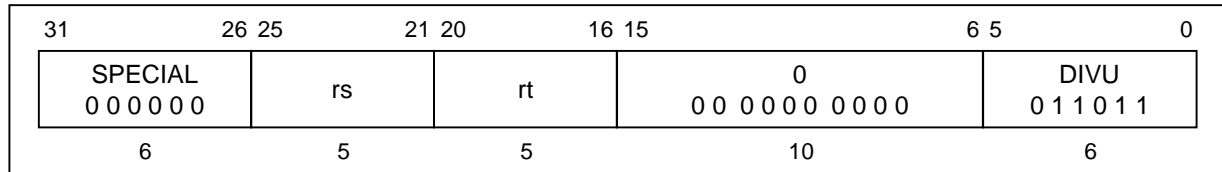
DIVU**Divide Unsigned****DIVU****Format:**

DIVU rs, rt

Description:

The contents of general register *rs* are divided by the contents of general register *rt*, treating both operands as unsigned values. No integer overflow exception occurs under any circumstances, and the result of this operation is undefined when the divisor is zero.

In 64-bit mode, the operands must be valid sign-extended, 32-bit values.

This instruction is typically followed by additional instructions to check for a zero divisor.

When the operation completes, the quotient word of the double result is loaded into special register *LO*, and the remainder word of the double result is loaded into special register *HI*.

If either of the two preceding instructions is MFHI or MFLO, the results of those instructions are undefined. Correct operation requires separating reads of *HI* or *LO* from writes by two or more instructions.

Operation:

32	T-2:	LO <- undefined
		HI <- undefined
	T-1:	LO <- undefined
		HI <- undefined
	T:	LO <- (0 GPR [rs]) div (0 GPR [rt])
		HI <- (0 GPR [rs]) mod (0 GPR [rt])
64	T-2:	LO <- undefined
		HI <- undefined
	T-1:	LO <- undefined
		HI <- undefined
	T:	q <- (0 GPR [rs] _{31..0}) div (0 GPR [rt] _{31..0})
		r <- (0 GPR [rs] _{31..0}) mod (0 GPR [rt] _{31..0})
		LO <- (q ₃₁) ³² q _{31..0}
		HI <- (r ₃₁) ³² r _{31..0}

Exceptions:

None

DMADD16 Doubleword Multiply and Add 16-bit integer DMADD16

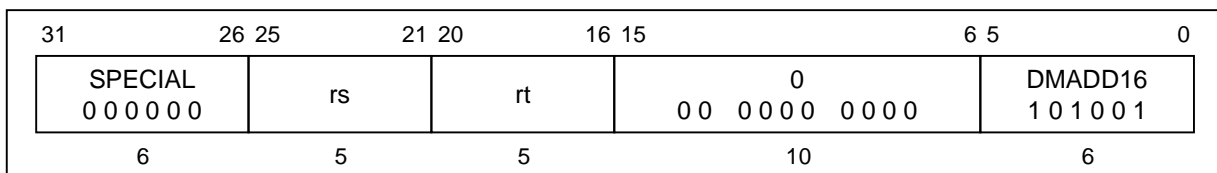

Format:

DMADD16 rs, rt

Description:

The contents of general registers *rs* and *rt* are multiplied, treating both operands as 16-bit 2's complement values. The operand[62:15] must be valid 15-bit, sign-extended values. If not, the result is unpredictable.

This multiplied result and the 64-bit data joined of special register *LO* is added to form the result as a signed integer. When the operation completes, the doubleword result is loaded into special register *LO*.

No integer overflow exception occurs under any circumstances.

This operation is only defined for the VR4102 operating in 64-bit mode. Execution of this instruction in 32-bit user or supervisor mode causes a reserved instruction exception.

The following table shows hazard cycles between DMADD16 and other instructions.

Instruction sequence	No. of cycles
MULT/MULTU -> DMADD16	1 Cycle
DMULT/DMULTU -> DMADD16	4 Cycles
DIV/DIVU -> DMADD16	36 Cycles
DDIV/DDIVU -> DMADD16	68 Cycles
MFHI/MFLO -> DMADD16	2 Cycles
MADD16 -> DMADD16	0 Cycles
DMADD16 -> DMADD16	0 Cycles

DMADD16 Doubleword Multiply and Add 16-bit integer DMADD16 (Continued)

Operation:

64	T-2:	LO	<- undefined
		HI	<- undefined
	T-1:	LO	<- undefined
		HI	<- undefined
	T:	temp	<- GPR [rs] * GPR [rt]
		temp	<- temp + LO
		LO	<- temp
		HI	<- undefined

Exceptions:

Reserved instruction exception (VR4102 in 32-bit user mode, VR4102 in 32-bit supervisor mode)

DMFC0 Doubleword Move From System Control Coprocessor DMFC0

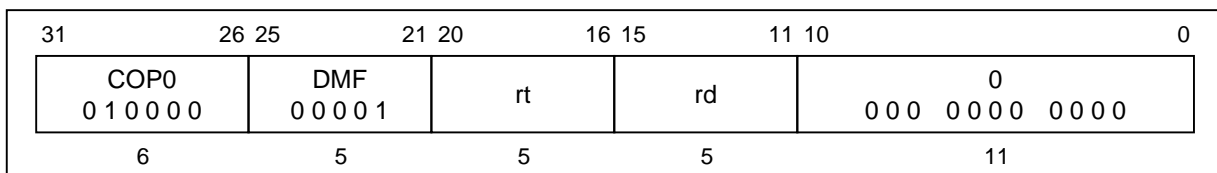

Format:

DMFC0 rt, rd

Description:

The contents of coprocessor register *rd* of the CP0 are loaded into general register *rt*.

This operation is defined for the VR4102 operating in 64-bit mode and in 32-bit kernel mode. Execution of this instruction in 32-bit user or supervisor mode causes a reserved instruction exception. All 64-bits of the general register destination are written from the coprocessor register source. The operation of DMFC0 on a 32-bit coprocessor 0 register is undefined.

Operation:

64 T: data <- CPR [0, rd] T+1: GPR [rt] <- data
--

Exceptions:

Coprocessor unusable exception (user mode and supervisor mode if CP0 not enabled)

Reserved instruction exception (VR4102 in 32-bit user mode, VR4102 in 32-bit supervisor mode)

DMTC0 Doubleword Move To System Control Coprocessor DMTC0

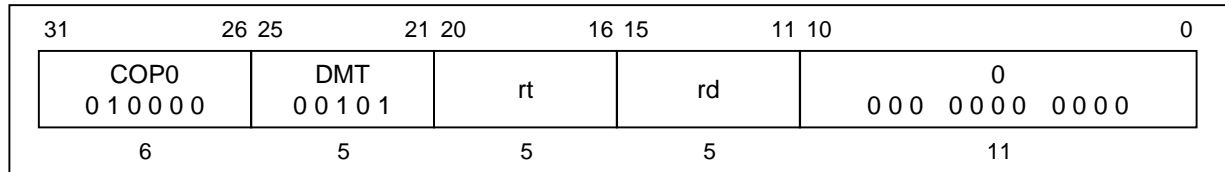

Format:

DMTC0 *rt*, *rd*

Description:

The contents of general register *rt* are loaded into coprocessor register *rd* of the CP0.

This operation is defined for the VR4102 operating in 64-bit mode or in 32-bit kernel mode. Execution of this instruction in 32-bit user or supervisor mode causes a reserved instruction exception.

All 64-bits of the coprocessor 0 register are written from the general register source. The operation of DMTC0 on a 32-bit coprocessor 0 register is undefined.

Because the state of the virtual address translation system may be altered by this instruction, the operation of load instructions, store instructions, and TLB operations immediately prior to and after this instruction are undefined.

Operation:

64	T: data ← GPR [<i>rt</i>]
	T+1: CPR [0, <i>rd</i>] ← data

Exceptions:

Coprocessor unusable exception (In user and supervisor mode if CP0 not enabled)

Reserved instruction exception (VR4102 in 32-bit user mode, VR4102 in 32-bit supervisor mode)

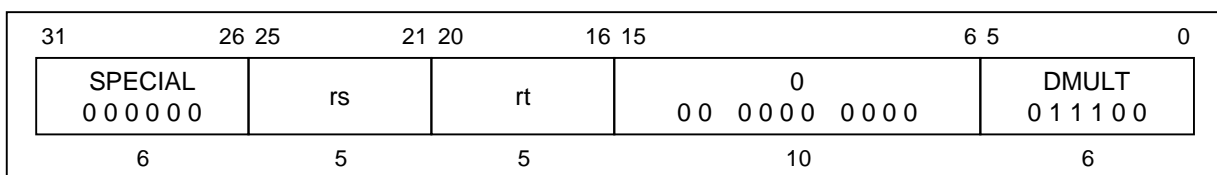
DMULT**Doubleword Multiply****DMULT****Format:**

DMULT rs, rt

Description:

The contents of general registers *rs* and *rt* are multiplied, treating both operands as 2's complement values. No integer overflow exception occurs under any circumstances.

When the operation completes, the low-order word of the double result is loaded into special register *LO*, and the high-order word of the double result is loaded into special register *HI*.

If either of the two preceding instructions is MFHI or MFLO, the results of these instructions are undefined. Correct operation requires separating reads of *HI* or *LO* from writes by a minimum of two other instructions.

This operation is only defined for the VR4102 operating in 64-bit mode. Execution of this instruction in 32-bit user or supervisor mode causes a reserved instruction exception.

Operation:

64	T-2:	LO	<- undefined
		HI	<- undefined
	T-1:	LO	<- undefined
		HI	<- undefined
	T:	t	<- GPR [rs] * GPR [rt]
		LO	<- t _{63..0}
		HI	<- t _{127..64}

Exceptions:

Reserved instruction exception (VR4102 in 32-bit user mode, VR4102 in 32-bit supervisor mode)

DMULTU Doubleword Multiply Unsigned DMULTU

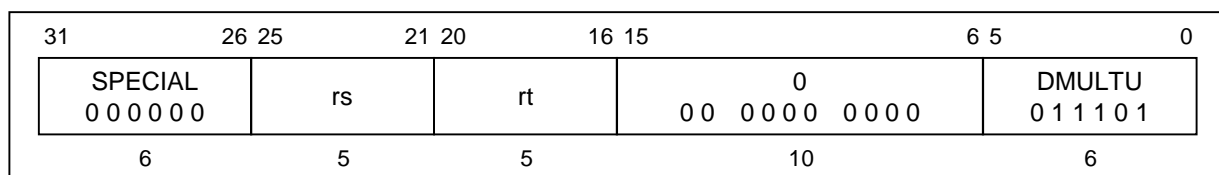
**Format:**

DMULTU rs, rt

Description:

The contents of general register *rs* and the contents of general register *rt* are multiplied, treating both operands as unsigned values. No overflow exception occurs under any circumstances.

When the operation completes, the low-order word of the double result is loaded into special register *LO*, and the high-order word of the double result is loaded into special register *HI*.

If either of the two preceding instructions is MFHI or MFLO, the results of these instructions are undefined. Correct operation requires separating reads of *HI* or *LO* from writes by a minimum of two instructions.

This operation is only defined for the VR4102 operating in 64-bit mode. Execution of this instruction in 32-bit user or supervisor mode causes a reserved instruction exception.

Operation:

64	T-2:	LO	<- undefined
		HI	<- undefined
	T-1:	LO	<- undefined
		HI	<- undefined
	T:	t	<- (0 GPR [rs]) * (0 GPR [rt])
		LO	<- t _{63..0}
		HI	<- t _{127..64}

Exceptions:

Reserved instruction exception (VR4102 in 32-bit user mode, VR4102 in 32-bit supervisor mode)

DSLL Doubleword Shift Left Logical DSLL

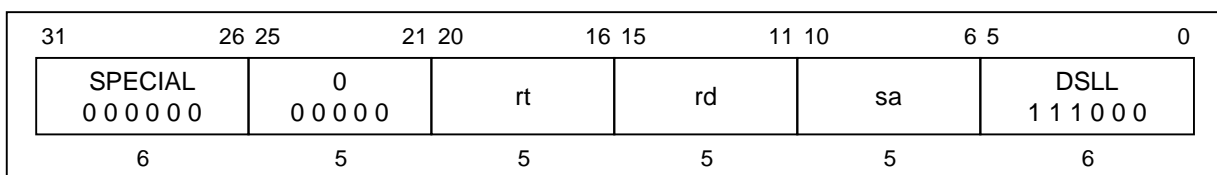
**Format:**

DSLL rd, rt, sa

Description:

The contents of general register *rt* are shifted left by *sa* bits, inserting zeros into the low-order bits. The result is placed in register *rd*.

This operation is only defined for the VR4102 operating in 64-bit mode. Execution of this instruction in 32-bit user or supervisor mode causes a reserved instruction exception.

Operation:

64 T: $s \leftarrow 0 \parallel sa$
 $GPR [rd] \leftarrow GPR [rt]_{(63-s)..0} \parallel 0^s$

Exceptions:

Reserved instruction exception (VR4102 in 32-bit user mode, VR4102 in 32-bit supervisor mode)

DSLLV Doubleword Shift Left Logical Variable DSLLV

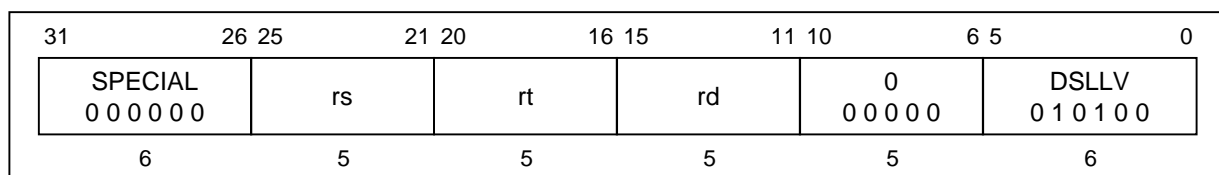
**Format:**

DSLLV rd, rt, rs

Description:

The contents of general register *rt* are shifted left by the number of bits specified by the low-order six bits contained in general register *rs*, inserting zeros into the low-order bits. The result is placed in register *rd*.

This operation is only defined for the VR4102 operating in 64-bit mode. Execution of this instruction in 32-bit user or supervisor mode causes a reserved instruction exception.

Operation:

64 T: $s \leftarrow \text{GPR}[rs]_{5:0}$
 $\text{GPR}[rd] \leftarrow \text{GPR}[rt]_{(63-s):0} \ll 0^s$

Exceptions:

Reserved instruction exception (VR4102 in 32-bit user mode, VR4102 in 32-bit supervisor mode)

DSLL32 Doubleword Shift Left Logical + 32 DSLL32

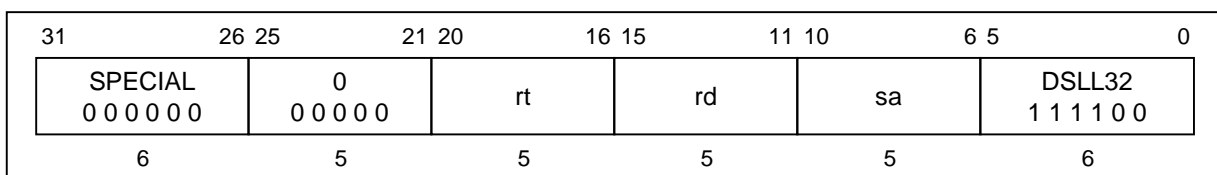
**Format:**

DSLL32 rd, rt, sa

Description:

The contents of general register *rt* are shifted left by $32 + sa$ bits, inserting zeros into the low-order bits. The result is placed in register *rd*.

This operation is only defined for the VR4102 operating in 64-bit mode. Execution of this instruction in 32-bit user or supervisor mode causes a reserved instruction exception.

Operation:

64 T: $s <- 1 \parallel sa$
 $GPR [rd] <- GPR [rt]_{(63-s)..0} \parallel 0^s$

Exceptions:

Reserved instruction exception (VR4102 in 32-bit user mode, VR4102 in 32-bit supervisor mode)

DSRA Doubleword Shift Right Arithmetic DSRA

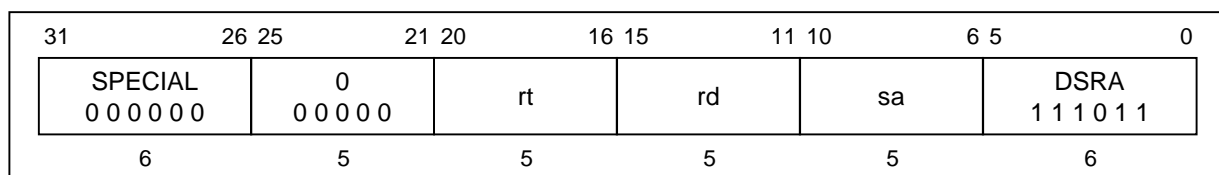
**Format:**

DSRA rd, rt, sa

Description:

The contents of general register *rt* are shifted right by *sa* bits, sign-extending the high-order bits. The result is placed in register *rd*.

This operation is only defined for the VR4102 operating in 64-bit mode. Execution of this instruction in 32-bit user or supervisor mode causes a reserved instruction exception.

Operation:

64 T: $s \leftarrow 0 \parallel sa$
 $GPR [rd] \leftarrow (GPR [rt]_{63})^s \parallel GPR [rt]_{63..s}$

Exceptions:

Reserved instruction exception (VR4102 in 32-bit user mode, VR4102 in 32-bit supervisor mode)

DSRAV Doubleword Shift Right Arithmetic Variable DSRAV

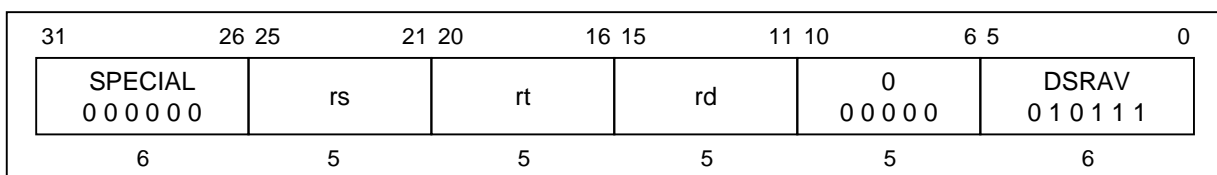
**Format:**

DSRAV rd, rt, rs

Description:

The contents of general register *rt* are shifted right by the number of bits specified by the low-order six bits of general register *rs*, sign-extending the high-order bits. The result is placed in register *rd*.

This operation is only defined for the VR4102 operating in 64-bit mode. Execution of this instruction in 32-bit user or supervisor mode causes a reserved instruction exception.

Operation:

64 T: $s \leftarrow \text{GPR}[rs]_{5..0}$ $\text{GPR}[rd] \leftarrow (\text{GPR}[rt]_{63})^s \parallel \text{GPR}[rt]_{63..s}$
--

Exceptions:

Reserved instruction exception (VR4102 in 32-bit user mode, VR4102 in 32-bit supervisor mode)

DSRA32 Doubleword Shift Right Arithmetic + 32 DSRA32

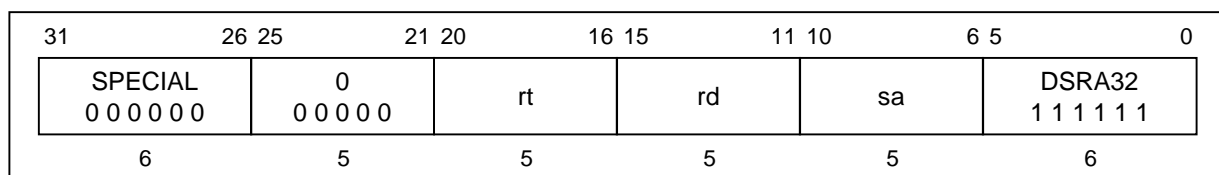
**Format:**

DSRA32 rd, rt, sa

Description:

The contents of general register *rt* are shifted right by $32 + sa$ bits, sign-extending the high-order bits. The result is placed in register *rd*.

This operation is only defined for the VR4102 operating in 64-bit mode. Execution of this instruction in 32-bit user or supervisor mode causes a reserved instruction exception.

Operation:

64 T: $s \leftarrow 1 \parallel sa$
 $GPR [rd] \leftarrow (GPR [rt]_{63})^s \parallel GPR [rt]_{63..s}$

Exceptions:

Reserved instruction exception (VR4102 in 32-bit user mode, VR4102 in 32-bit supervisor mode)

DSRL Doubleword Shift Right Logical DSRL

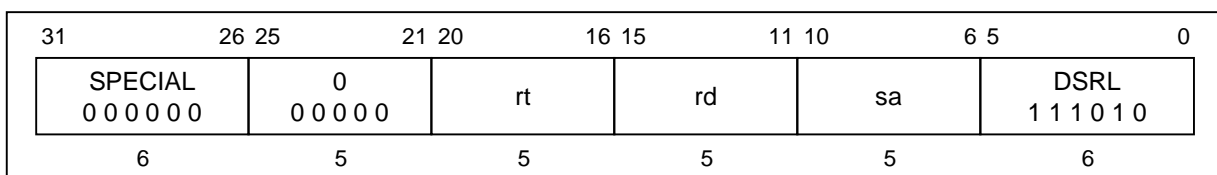
**Format:**

DSRL rd, rt, sa

Description:

The contents of general register *rt* are shifted right by *sa* bits, inserting zeros into the high-order bits. The result is placed in register *rd*.

This operation is only defined for the VR4102 operating in 64-bit mode. Execution of this instruction in 32-bit user or supervisor mode causes a reserved instruction exception.

Operation:

64 T: $s \leftarrow 0 \parallel sa$
 $GPR [rd] \leftarrow 0^s \parallel GPR [rt]_{63..s}$

Exceptions:

Reserved instruction exception (VR4102 in 32-bit user mode, VR4102 in 32-bit supervisor mode)

DSRLV Doubleword Shift Right Logical Variable DSRLV

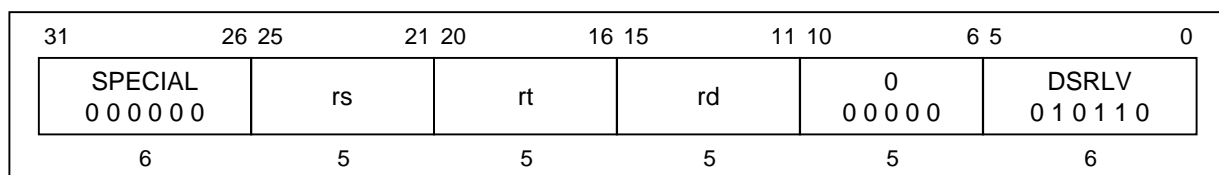
**Format:**

DSRLV rd, rt, rs

Description:

The contents of general register *rt* are shifted right by the number of bits specified by the low-order six bits of general register *rs*, inserting zeros into the high-order bits. The result is placed in register *rd*.

This operation is only defined for the VR4102 operating in 64-bit mode. Execution of this instruction in 32-bit user or supervisor mode causes a reserved instruction exception.

Operation:

64 T: $s \leftarrow \text{GPR}[rs]_{5..0}$
 $\text{GPR}[rd] \leftarrow 0^s \parallel \text{GPR}[rt]_{63..s}$

Exceptions:

Reserved instruction exception (VR4102 in 32-bit user mode, VR4102 in 32-bit supervisor mode)

DSRL32 Doubleword Shift Right Logical + 32 DSRL32

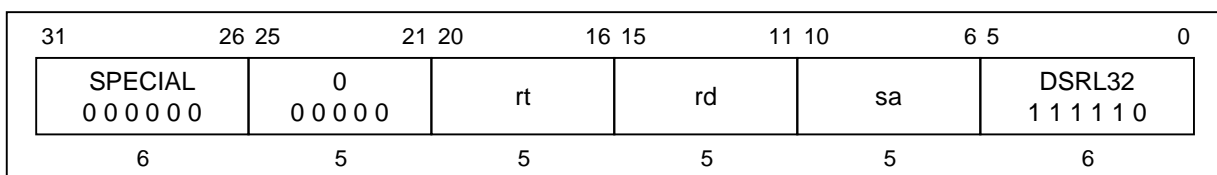
**Format:**

DSRL32 rd, rt, sa

Description:

The contents of general register *rt* are shifted right by $32 + sa$ bits, inserting zeros into the high-order bits. The result is placed in register *rd*.

This operation is only defined for the VR4102 operating in 64-bit mode. Execution of this instruction in 32-bit user or supervisor mode causes a reserved instruction exception.

Operation:

64 T: $s <- 1 \parallel sa$
 $GPR [rd] <- 0^s \parallel GPR [rt]_{63..s}$

Exceptions:

Reserved instruction exception (VR4102 in 32-bit user mode, VR4102 in 32-bit supervisor mode)

DSUB Doubleword Subtract DSUB

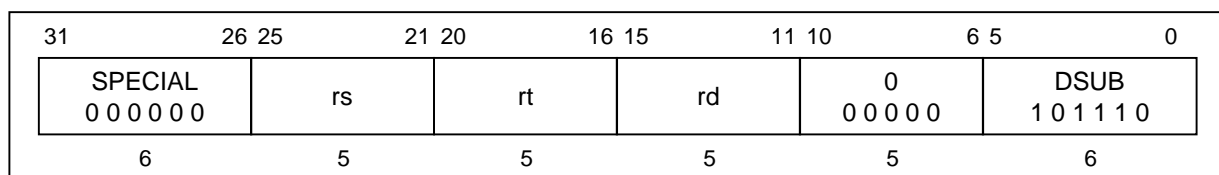
**Format:**

DSUB rd, rs, rt

Description:

The contents of general register *rt* are subtracted from the contents of general register *rs* to form a result. The result is placed into general register *rd*.

The only difference between this instruction and the DSUBU instruction is that DSUBU never traps on overflow.

An integer overflow exception takes place if the carries out of bits 62 and 63 differ (2's complement overflow). The destination register *rd* is not modified when an integer overflow exception occurs.

This operation is only defined for the VR4102 operating in 64-bit mode. Execution of this instruction in 32-bit user or supervisor mode causes a reserved instruction exception.

Operation:

64 T: GPR [rd] <- GPR [rs] - GPR [rt]

Exceptions:

Integer overflow exception

Reserved instruction exception (VR4102 in 32-bit user mode, VR4102 in 32-bit supervisor mode)

DSUBU Doubleword Subtract Unsigned DSUBU

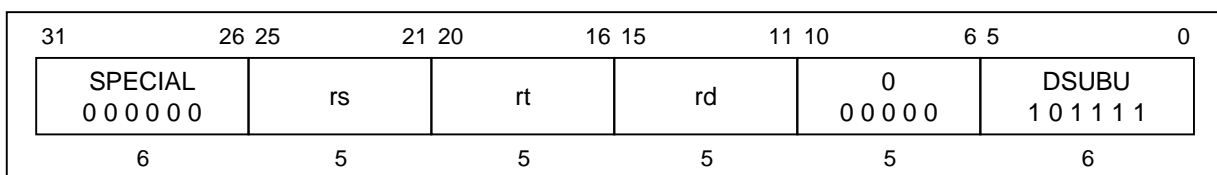
**Format:**

DSUBU rd, rs, rt

Description:

The contents of general register *rt* are subtracted from the contents of general register *rs* to form a result. The result is placed into general register *rd*.

The only difference between this instruction and the DSUB instruction is that DSUBU never traps on overflow. No integer overflow exception occurs under any circumstances.

This operation is only defined for the VR4102 operating in 64-bit mode. Execution of this instruction in 32-bit user or supervisor mode causes a reserved instruction exception.

Operation:

64 T: GPR [rd] <- GPR [rs] - GPR [rt]

Exceptions:

Reserved instruction exception (VR4102 in 32-bit user mode, VR4102 in 32-bit supervisor mode)

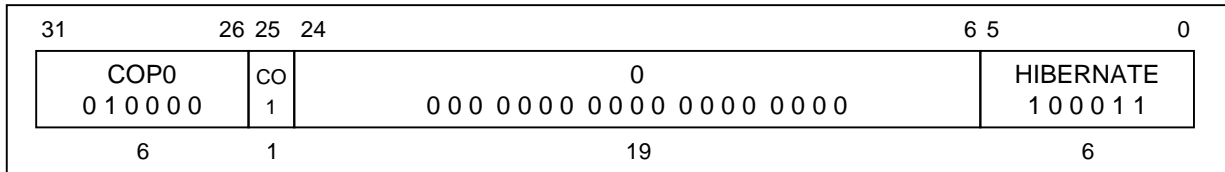
HIBERNATE**Hibernate****HIBERNATE****Format:**

HIBERNATE

Description:

HIBERNATE instruction starts mode transition from Fullspeed mode to Hibernate mode.

When the HIBERNATE instruction finishes the WB stage, the VR4102 wait by the SysAD bus is idle state, after then the internal clocks and the system interface clocks will shut down, thus freezing the pipeline.

Once the VR4102 is in Hibernate mode, the Cold Reset sequence will cause the VR4102 to exit Hibernate mode and to enter Fullspeed mode.

Operation:

32, 64 T:

T+1: Hibernate operation ()

Exceptions:

Coprocessor unusable exception

Remark Refer to Chapter 15 for details about the operation of the peripheral units at mode transition.

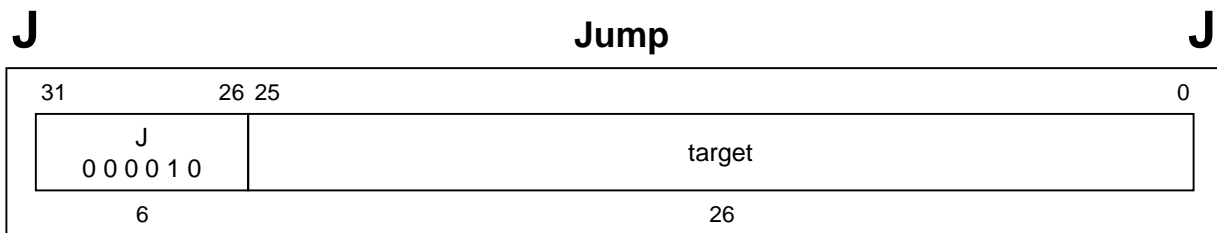
**Format:**

J target

Description:

The 26-bit target address is shifted left two bits and combined with the high-order four bits of the address of the delay slot. The program unconditionally jumps to this calculated address with a delay of one instruction.

Operation:

32	T: temp <- target
	T+1: PC <- PC _{31..28} temp 0 ²
64	T: temp <- target
	T+1: PC <- PC _{63..28} temp 0 ²

Exceptions:

None

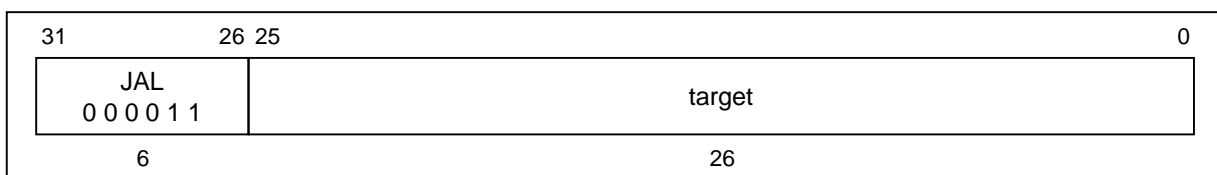
JAL**Jump And Link****JAL****Format:**

JAL target

Description:

The 26-bit target address is shifted left two bits and combined with the high-order four bits of the address of the delay slot. The program unconditionally jumps to this calculated address with a delay of one instruction. The address of the instruction after the delay slot is placed in the link register, *r31*.

Operation:

32	T: temp <- target GPR [31] <- PC + 8 T+1: PC <- PC _{31..28} temp 0 ²
64	T: temp <- target GPR [31] <- PC + 8 T+1: PC <- PC _{63..28} temp 0 ²

Exceptions:

None

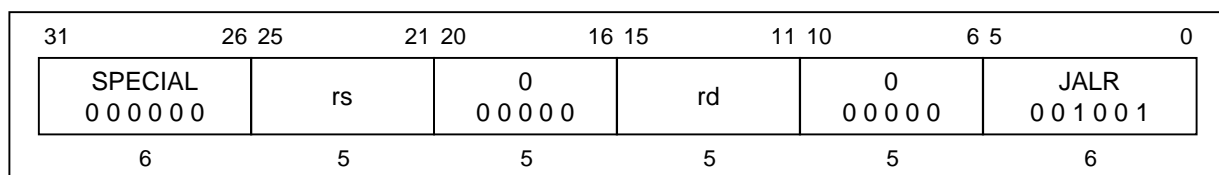
JALR**Jump And Link Register****JALR****Format:**JALR *rs*JALR *rd*, *rs*

www.DataSheet4U.com

Description:

The program unconditionally jumps to the address contained in general register *rs*, with a delay of one instruction. The address of the instruction after the delay slot is placed in general register *rd*. The default value of *rd*, if omitted in the assembly language instruction, is 31.

Register specifiers *rs* and *rd* may not be equal, because such an instruction does not have the same effect when re-executed. However, an attempt to execute this instruction is *not* trapped, and the result of executing such an instruction is undefined.

Since instructions must be word-aligned, a **Jump and Link Register** instruction must specify a target register (*rs*) which contains an address whose two low-order bits are zero. If these low-order bits are not zero, an address error exception will occur when the jump target instruction is subsequently fetched.

Operation:

```

32,64 T:  temp <- GPR [rs]
          GPR [rd] <- PC + 8
          T+1: PC <- temp

```

Exceptions:

None

JR Jump Register JR

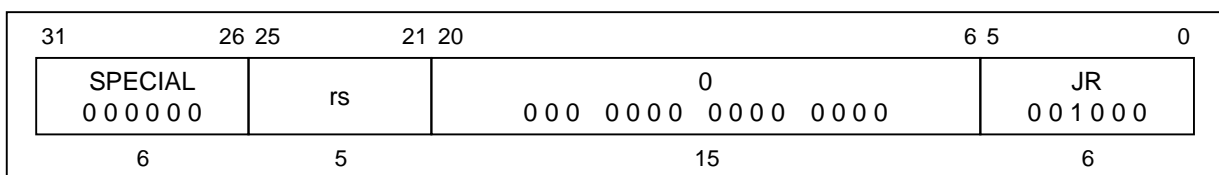
**Format:**

JR rs

Description:

The program unconditionally jumps to the address contained in general register *rs*, with a delay of one instruction.

Since instructions must be word-aligned, a **Jump Register** instruction must specify a target register (*rs*) which contains an address whose two low-order bits are zero. If these low-order bits are not zero, an address error exception will occur when the jump target instruction is subsequently fetched.

Operation:

32,64 T: temp <- GPR [rs]
T+1: PC <- temp

Exceptions:

None

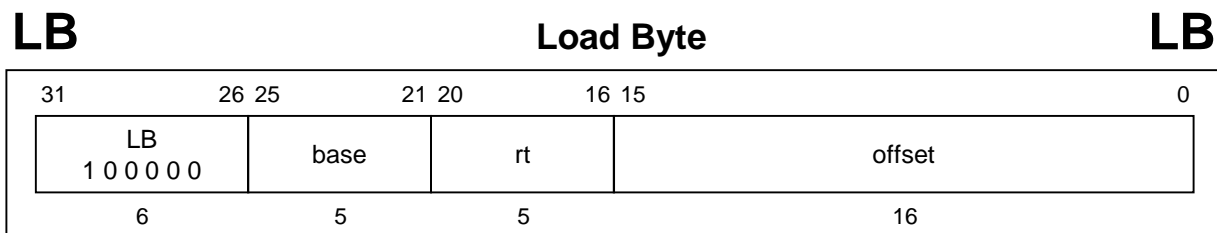
**Format:**LB *rt*, *offset* (*base*)**Description:**

The 16-bit *offset* is sign-extended and added to the contents of general register *base* to form a virtual address. The contents of the byte at the memory location specified by the effective address are sign-extended and loaded into general register *rt*.

Operation:

```

32  T:  vAddr <- ((offset15)16 || offset15..0) + GPR [base]
      (pAddr, uncached) <- AddressTranslation (vAddr, DATA)
      pAddr <- pAddrPSIZE - 1..3 || (pAddr2..0 xor ReverseEndian3)
      mem <- LoadMemory (uncached, BYTE, pAddr, vAddr, DATA)
      byte <- vAddr2..0 xor BigEndianCPU3
      GPR [rt] <- (mem7 + 8* byte)24 || mem7 + 8* byte..8* byte

64  T:  vAddr <- ((offset15)48 || offset15..0) + GPR [base]
      (pAddr, uncached) <- AddressTranslation (vAddr, DATA)
      pAddr <- pAddrPSIZE - 1..3 || (pAddr2..0 xor ReverseEndian3)
      mem <- LoadMemory (uncached, BYTE, pAddr, vAddr, DATA)
      byte <- vAddr2..0 xor BigEndianCPU3
      GPR [rt] <- (mem7 + 8* byte)56 || mem7 + 8* byte..8* byte

```

Exceptions:

- TLB refill exception
- TLB invalid exception
- Bus error exception
- Address error exception

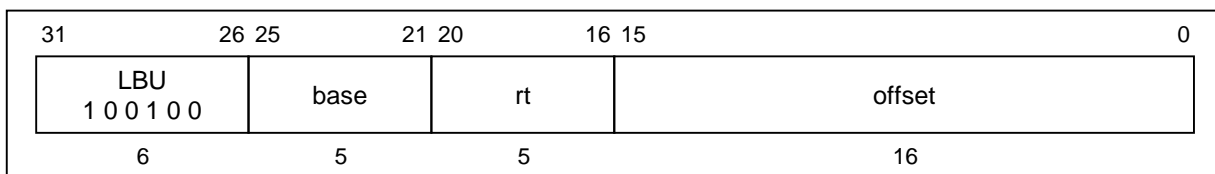
LBU**Load Byte Unsigned****LBU****Format:**

LBU rt, offset (base)

Description:

The 16-bit *offset* is sign-extended and added to the contents of general register *base* to form a virtual address. The contents of the byte at the memory location specified by the effective address are zero-extended and loaded into general register *rt*.

Operation:

```

32  T:  vAddr <- ((offset15)16 || offset15..0) + GPR [base]
      (pAddr, uncached) <- AddressTranslation (vAddr, DATA)
      pAddr <- pAddrPSIZE - 1..3 || (pAddr2..0 xor ReverseEndian3)
      mem <- LoadMemory (uncached, BYTE, pAddr, vAddr, DATA)
      byte <- vAddr2..0 xor BigEndianCPU3
      GPR [rt] <- 024 || mem7 + 8* byte..8* byte

64  T:  vAddr <- ((offset15)48 || offset15..0) + GPR [base]
      (pAddr, uncached) <- AddressTranslation (vAddr, DATA)
      pAddr <- pAddrPSIZE - 1..3 || (pAddr2..0 xor ReverseEndian3)
      mem <- LoadMemory (uncached, BYTE, pAddr, vAddr, DATA)
      byte <- vAddr2..0 xor BigEndianCPU3
      GPR [rt] <- 056 || mem7 + 8* byte..8* byte

```

Exceptions:

- TLB refill exception
- TLB invalid exception
- Bus error exception
- Address error exception

LD Load Doubleword LD

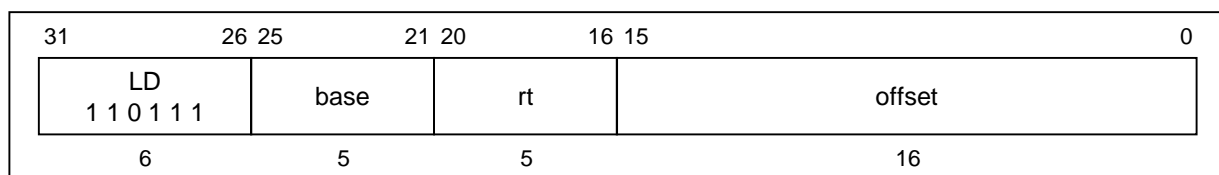
**Format:**LD *rt*, *offset* (*base*)**Description:**

The 16-bit *offset* is sign-extended and added to the contents of general register *base* to form a virtual address. The contents of the 64-bit doubleword at the memory location specified by the effective address are loaded into general register *rt*.

If any of the three least-significant bits of the effective address are non-zero, an address error exception occurs.

This operation is only defined for the VR4102 operating in 64-bit mode. Execution of this instruction in 32-bit user or supervisor mode causes a reserved instruction exception.

Operation:

```

64  T:  vAddr <- ((offset15)48 || offset15..0) + GPR [base]
      (pAddr, uncached) <- AddressTranslation (vAddr, DATA)
      data <- LoadMemory (uncached, DOUBLEWORD, pAddr, vAddr, DATA)
      GPR [rt] <- data

```

Exceptions:

TLB refill exception

TLB invalid exception

Bus error exception

Address error exception

Reserved instruction exception (VR4102 in 32-bit user mode, VR4102 in 32-bit supervisor mode)

LDL **Load Doubleword Left** **LDL**

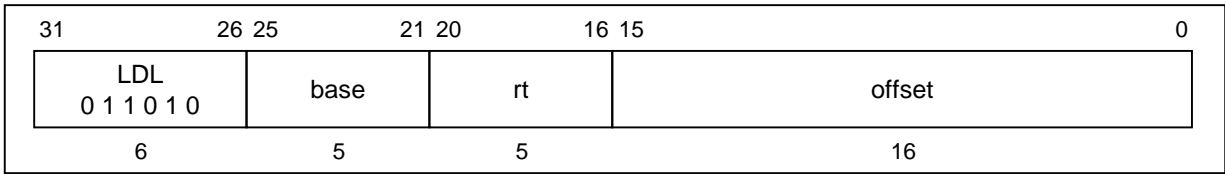

Format:

LDL rt, offset (base)

Description:

This instruction can be used in combination with the LDR instruction to load a register with eight consecutive bytes from memory, when the bytes cross a doubleword boundary. LDL loads the left portion of the register with the appropriate part of the high-order doubleword; LDR loads the right portion of the register with the appropriate part of the low-order doubleword.

The LDL instruction adds its sign-extended 16-bit *offset* to the contents of general register *base* to form a virtual address which can specify an arbitrary byte. It reads bytes only from the doubleword in memory which contains the specified starting byte. From one to eight bytes will be loaded, depending on the starting byte specified.

Conceptually, it starts at the specified byte in memory and loads that byte into the high-order (left-most) byte of the register; then it loads bytes from memory into the register until it reaches the low-order byte of the doubleword in memory. The least-significant (right-most) byte(s) of the register will not be changed.

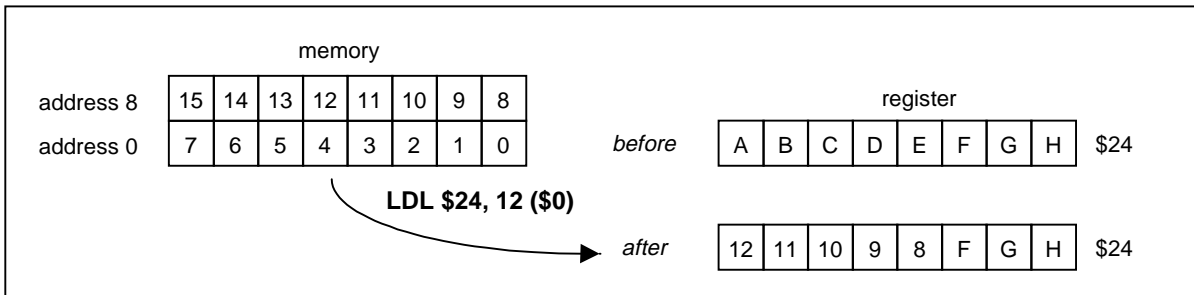

LDL**Load Doubleword Left
(Continued)****LDL**

The contents of general register *rt* are internally bypassed within the processor so that no NOP is needed between an immediately preceding load instruction which specifies register *rt* and a following LDL (or LDR) instruction which also specifies register *rt*.

No address error exceptions due to alignment are possible.

This operation is only defined for the VR4102 operating in 64-bit mode. Execution of this instruction in 32-bit user or supervisor mode causes a reserved instruction exception.

Operation:

```

64  T:  vAddr <- ((offset15)48 || offset15..0) + GPR [base]
      (pAddr, uncached) <- AddressTranslation (vAddr, DATA)
      pAddr <- pAddrPSIZE - 1..3 || (pAddr2..0 xor ReverseEndian3)
      if BigEndianMem = 0 then
          pAddr <- pAddrPSIZE - 1..3 || 03
      endif
      byte <- vAddr2..0 xor BigEndianCPU3
      mem <- LoadMemory (uncached, byte, pAddr, vAddr, DATA)
      GPR [rt] <- mem7 + 8*byte..0 || GPR [rt]55 - 8*byte..0

```

LDL

Load Doubleword Left (Continued)

LDL

Given a doubleword in a register and a doubleword in memory, the operation of LDL is as follows:

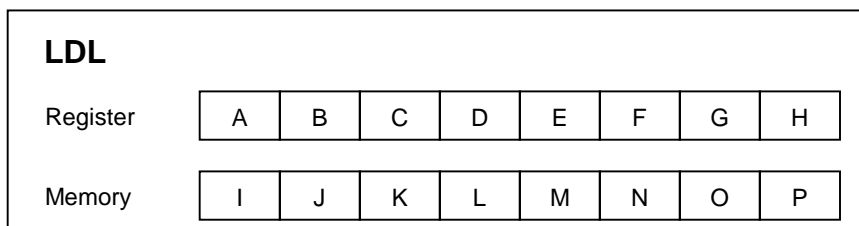

www.DataSheet4U.com

vAddr _{2,0}	BigEndianCPU = 0		
	destination	type	offset (LEM)
0	P B C D E F G H	0	0
1	O P C D E F G H	1	0
2	N O P D E F G H	2	0
3	M N O P E F G H	3	0
4	L M N O P F G H	4	0
5	K L M N O P G H	5	0
6	J K L M N O P H	6	0
7	I J K L M N O P	7	0

- LEM* Little-endian memory (BigEndianMem = 0)
- Type* AccessType (see Table 3-2) sent to memory
- Offset* pAddr_{2,0} sent to memory

Exceptions:

- TLB refill exception
- TLB invalid exception
- Bus error exception
- Address error exception
- Reserved instruction exception (VR4102 in 32-bit user mode, VR4102 in 32-bit supervisor mode)

LDR**Load Doubleword Right
(Continued)****LDR**

The contents of general register *rt* are internally bypassed within the processor so that no NOP is needed between an immediately preceding load instruction which specifies register *rt* and a following LDR (or LDL) instruction which also specifies register *rt*.

No address error exceptions due to alignment are possible.

This operation is only defined for the VR4102 operating in 64-bit mode. Execution of this instruction in 32-bit user or supervisor mode causes a reserved instruction exception.

www.DataSheet4U.com

Operation:

```

64  T:  vAddr <- ((offset15)48 || offset15..0) + GPR [base]
      (pAddr, uncached) <- AddressTranslation (vAddr, DATA)
      pAddr <- pAddrPSIZE - 1..3 || (pAddr2..0 xor ReverseEndian3)
      if BigEndianMem = 1 then
          pAddr <- pAddrPSIZE - 1..3 || 03
      endif
      byte <- vAddr2..0 xor BigEndianCPU3
      mem <- LoadMemory (uncached, DOUBLEWORD-byte, pAddr, vAddr, DATA)
      GPR [rt] <- GPR [rt]63..64 - 8 * byte || mem63..8 * byte

```

LDR**Load Doubleword Right
(Continued)****LDR**

Given a doubleword in a register and a doubleword in memory, the operation of LDR is as follows:

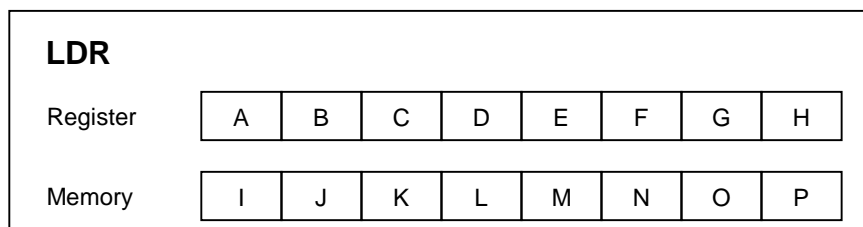

vAddr _{2,0}	BigEndianCPU = 0		
	destination	type	offset (LEM)
0	I J K L M N O P	7	0
1	A I J K L M N O	6	1
2	A B I J K L M N	5	2
3	A B C I J K L M	4	3
4	A B C D I J K L	3	4
5	A B C D E I J K	2	5
6	A B C D E F I J	1	6
7	A B C D E F G I	0	7

LEM Little-endian memory (BigEndianMem = 0)
Type AccessType (see Table 3-2) sent to memory
Offset pAddr_{2,0} sent to memory

Exceptions:

- TLB refill exception
- TLB invalid exception
- Bus error exception
- Address error exception
- Reserved instruction exception (VR4102 in 32-bit user mode, VR4102 in 32-bit supervisor mode)

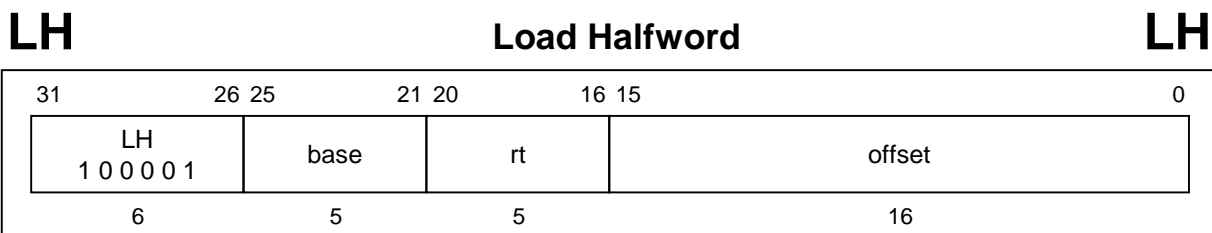
**Format:**

LH rt, offset (base)

Description:

The 16-bit *offset* is sign-extended and added to the contents of general register *base* to form a virtual address. The contents of the halfword at the memory location specified by the effective address are sign-extended and loaded into general register *rt*.

If the least-significant bit of the effective address is non-zero, an address error exception occurs.

Operation:

```

32  T:  vAddr <- ((offset15)16 || offset15...0) + GPR [base]
      (pAddr, uncached) <- AddressTranslation (vAddr, DATA)
      pAddr <- pAddrPSIZE - 1...3 || (pAddr2...0 xor (ReverseEndian2 || 0))
      mem <- LoadMemory (uncached, HALFWORD, pAddr, vAddr, DATA)
      byte <- vAddr2...0 xor (BigEndianCPU2 || 0)
      GPR [rt] <- (mem15 + 8 * byte)16 || mem15 + 8 * byte...8 * byte

64  T:  vAddr <- ((offset15)48 || offset15...0) + GPR [base]
      (pAddr, uncached) <- AddressTranslation (vAddr, DATA)
      pAddr <- pAddrPSIZE - 1...3 || (pAddr2...0 xor (ReverseEndian2 || 0))
      mem <- LoadMemory (uncached, HALFWORD, pAddr, vAddr, DATA)
      byte <- vAddr2...0 xor (BigEndianCPU2 || 0)
      GPR [rt] <- (mem15 + 8 * byte)48 || mem15 + 8 * byte...8 * byte

```

Exceptions:

- TLB refill exception
- TLB invalid exception
- Bus error exception
- Address error exception

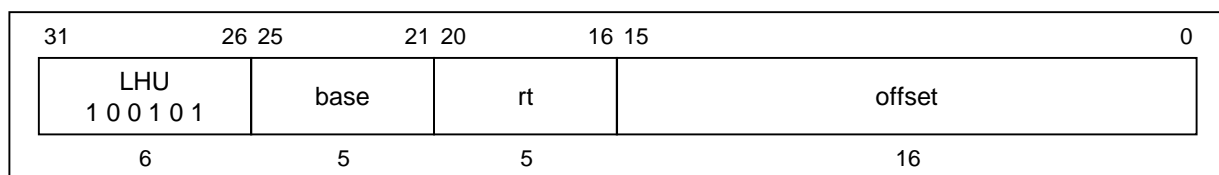
LHU**Load Halfword Unsigned****LHU****Format:**LHU *rt*, *offset* (*base*)**Description:**

The 16-bit *offset* is sign-extended and added to the contents of general register *base* to form a virtual address. The contents of the halfword at the memory location specified by the effective address are zero-extended and loaded into general register *rt*.

If the least-significant bit of the effective address is non-zero, an address error exception occurs.

Operation:

```

32  T:  vAddr <- ((offset15)16 || offset15...0) + GPR [base]
      (pAddr, uncached) <- AddressTranslation (vAddr, DATA)
      pAddr <- pAddrPSIZE - 1...3 || (pAddr2...0 xor (ReverseEndian2 || 0))
      mem <- LoadMemory (uncached, HALFWORD, pAddr, vAddr, DATA)
      byte <- vAddr2...0 xor (BigEndianCPU2 || 0)
      GPR [rt] <- 016 || mem15 + 8 * byte...8 * byte

64  T:  vAddr <- ((offset15)48 || offset15...0) + GPR [base]
      (pAddr, uncached) <- AddressTranslation (vAddr, DATA)
      pAddr <- pAddrPSIZE - 1...3 || (pAddr2...0 xor (ReverseEndian2 || 0))
      mem <- LoadMemory (uncached, HALFWORD, pAddr, vAddr, DATA)
      byte <- vAddr2...0 xor (BigEndianCPU2 || 0)
      GPR [rt] <- 048 || mem15 + 8 * byte...8 * byte

```

Exceptions:

- TLB refill exception
- TLB invalid exception
- Bus Error exception
- Address error exception

LW Load Word LW

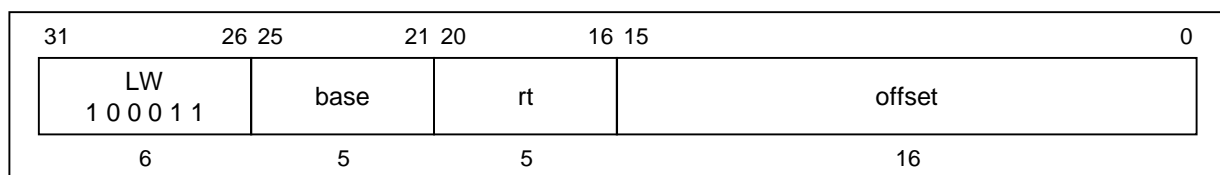

Format:

LW *rt*, *offset* (*base*)

Description:

The 16-bit *offset* is sign-extended and added to the contents of general register *base* to form a virtual address. The contents of the word at the memory location specified by the effective address are loaded into general register *rt*. In 64-bit mode, the loaded word is sign-extended.

If either of the two least-significant bits of the effective address is non-zero, an address error exception occurs.

Operation:

```

32  T:  vAddr <- ((offset15)16 || offset15...0) + GPR [base]
      (pAddr, uncached) <- AddressTranslation (vAddr, DATA)
      pAddr <- pAddrPSIZE - 1...3 || (pAddr2...0 xor (ReverseEndian || 02))
      mem <- LoadMemory (uncached, WORD, pAddr, vAddr, DATA)
      byte <- vAddr2...0 xor (BigEndianCPU || 02)
      GPR [rt] <- mem31 + 8 * byte...8 * byte

64  T:  vAddr <- ((offset15)48 || offset15...0) + GPR [base]
      (pAddr, uncached) <- AddressTranslation (vAddr, DATA)
      pAddr <- pAddrPSIZE - 1...3 || (pAddr2...0 xor (ReverseEndian || 02))
      mem <- LoadMemory (uncached, WORD, pAddr, vAddr, DATA)
      byte <- vAddr2...0 xor (BigEndianCPU || 02)
      GPR [rt] <- (mem31 + 8 * byte)32 || mem31 + 8 * byte...8 * byte
    
```

Exceptions:

- TLB refill exception
- TLB invalid exception
- Bus error exception
- Address error exception

LWL**Load Word Left
(Continued)****LWL**

The contents of general register *rt* are internally bypassed within the processor so that no NOP is needed between an immediately preceding load instruction which specifies register *rt* and a following LWL (or LWR) instruction which also specifies register *rt*.

No address error exceptions due to alignment are possible.

Operation:

```

32  T:  vAddr <- ((offset15)16 || offset15...0) + GPR [base]
      (pAddr, uncached) <- AddressTranslation (vAddr, DATA)
      pAddr <- pAddrPSIZE - 1...3 || (pAddr2...0 xor ReverseEndian3)
      if BigEndianMem = 0 then
          pAddr <- pAddrPSIZE - 1...2 || 02
      endif
      byte <- vAddr1...0 xor BigEndianCPU2
      word <- vAddr2 xor BigEndianCPU
      mem <- LoadMemory (uncached, byte, pAddr, vAddr, DATA)
      temp <- mem32 * word + 8 * byte + 7...32 * word || GPR [rt]23 - 8 * byte...0
      GPR [rt] <- temp

64  T:  vAddr <- ((offset15)48 || offset15...0) + GPR [base]
      (pAddr, uncached) <- AddressTranslation (vAddr, DATA)
      pAddr <- pAddrPSIZE - 1...3 || (pAddr2...0 xor ReverseEndian3)
      if BigEndianMem = 0 then
          pAddr <- pAddrPSIZE - 1...2 || 02
      endif
      byte <- vAddr1...0 xor BigEndianCPU2
      word <- vAddr2 xor BigEndianCPU
      mem <- LoadMemory (uncached, 0 || byte, pAddr, vAddr, DATA)
      temp <- mem32 * word + 8 * byte + 7...32 * word || GPR [rt]23 - 8 * byte...0
      GPR [rt] <- (temp31)32 || temp

```

LWL

Load Word Left (Continued)

LWL

Given a doubleword in a register and a doubleword in memory, the operation of LWL is as follows:

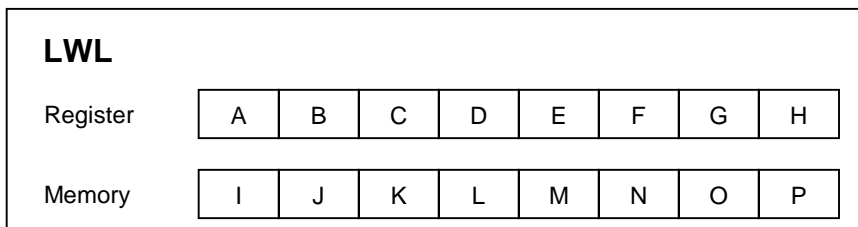

www.DataSheet4U.com

vAddr _{2..0}	BigEndianCPU = 0		
	destination	type	offset (LEM)
0	S S S S P F G H	0	0
1	S S S S O P G H	1	0
2	S S S S N O P H	2	0
3	S S S S M N O P	3	0
4	S S S S L F G H	0	4
5	S S S S K L G H	1	4
6	S S S S J K L H	2	4
7	S S S S I J K L	3	4

- LEM* Little-endian memory (BigEndianMem = 0)
- Type* AccessType (see Table 3-2) sent to memory
- Offset* pAddr_{2..0} sent to memory
- S* sign-extend of destination₃₁

Exceptions:

- TLB refill exception
- TLB invalid exception
- Bus error exception
- Address error exception

LWR **Load Word Right** **LWR**

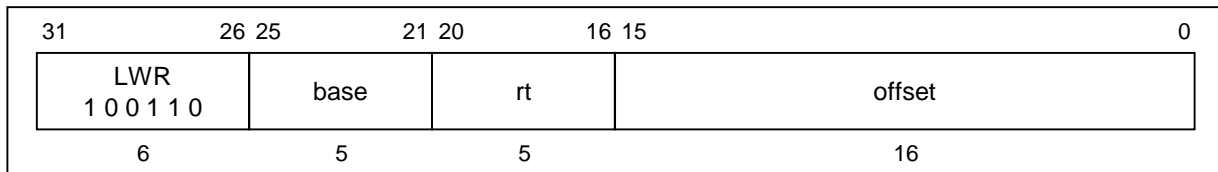

Format:

LWR rt, offset (base)

Description:

This instruction can be used in combination with the LWL instruction to load a register with four consecutive bytes from memory, when the bytes cross a word boundary. LWR loads the right portion of the register with the appropriate part of the low-order word; LWL loads the left portion of the register with the appropriate part of the high-order word.

The LWR instruction adds its sign-extended 16-bit *offset* to the contents of general register *base* to form a virtual address which can specify an arbitrary byte. It reads bytes only from the word in memory which contains the specified starting byte. From one to four bytes will be loaded, depending on the starting byte specified. In 64-bit mode, the loaded word is sign-extended.

Conceptually, it starts at the specified byte in memory and loads that byte into the low-order (right-most) byte of the register; then it loads bytes from memory into the register until it reaches the high-order byte of the word in memory. The most significant (left-most) byte(s) of the register will not be changed.

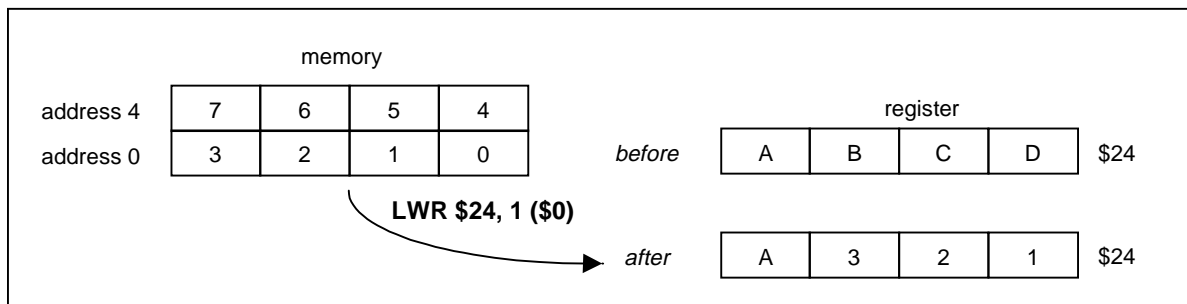

LWR**Load Word Right
(Continued)****LWR**

The contents of general register *rt* are internally bypassed within the processor so that no NOP is needed between an immediately preceding load instruction which specifies register *rt* and a following LWR (or LWL) instruction which also specifies register *rt*.

No address error exceptions due to alignment are possible.

Operation:

```

32  T:  vAddr <- ((offset15)16 || offset15...0) + GPR [base]
      (pAddr, uncached) <- AddressTranslation (vAddr, DATA)
      pAddr <- pAddrPSIZE - 1...3 || (pAddr2...0 xor ReverseEndian3)
      if BigEndianMem = 1 then
          pAddr <- pAddrPSIZE - 1...3 || 03
      endif
      byte <- vAddr1...0 xor BigEndianCPU2
      word <- vAddr2 xor BigEndianCPU
      mem <- LoadMemory (uncached, 0 || byte, pAddr, vAddr, DATA)
      temp <- GPR [rt]31...32 - 8 * byte || mem31 + 32 * word...32 * word + 8 * byte
      GPR [rt] <- temp

64  T:  vAddr <- ((offset15)48 || offset15...0) + GPR [base]
      (pAddr, uncached) <- AddressTranslation (vAddr, DATA)
      pAddr <- pAddrPSIZE - 1...3 || (pAddr2...0 xor ReverseEndian3)
      if BigEndianMem = 1 then
          pAddr <- pAddrPSIZE - 1...3 || 03
      endif
      byte <- vAddr1...0 xor BigEndianCPU2
      word <- vAddr2 xor BigEndianCPU
      mem <- LoadMemory (uncached, WORD-byte, pAddr, vAddr, DATA)
      temp <- GPR [rt]31...32 - 8 * byte || mem31 + 32 * word...32 * word + 8 * byte
      GPR [rt] <- (temp31)32 || temp

```

LWR

Load Word Right (Continued)

LWR

Given a word in a register and a word in memory, the operation of LWR is as follows:

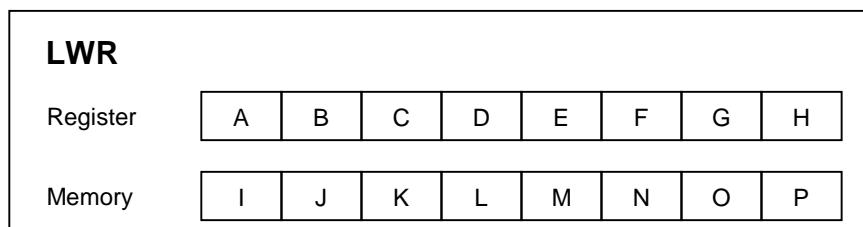

www.DataSheet4U.com

vAddr _{2..0}	BigEndianCPU = 0		
	destination	type	offset (LEM)
0	S S S S M N O P	3	0
1	S S S S E M N O	2	1
2	S S S S E F M N	1	2
3	S S S S E F G M	0	3
4	S S S S I J K L	3	4
5	S S S S E I J K	2	5
6	S S S S E F I J	1	6
7	S S S S E F G I	0	7

- LEM* Little-endian memory (BigEndianMem = 0)
- Type* AccessType (see Table 3-2) sent to memory
- Offset* pAddr_{2..0} sent to memory
- S* sign-extend of destination₃₁

Exceptions:

- TLB refill exception
- TLB invalid exception
- Bus error exception
- Address error exception

LWU Load Word Unsigned LWU

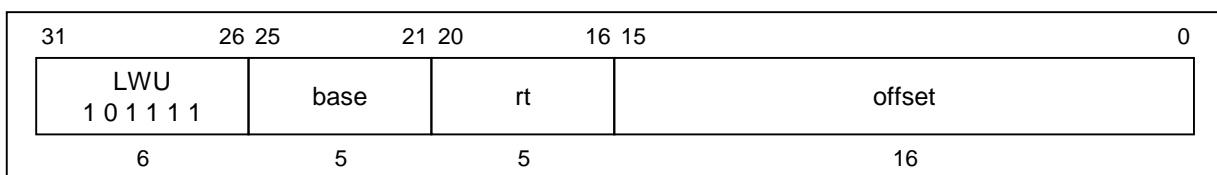
**Format:**LWU *rt*, *offset* (*base*)**Description:**

The 16-bit *offset* is sign-extended and added to the contents of general register *base* to form a virtual address. The contents of the word at the memory location specified by the effective address are loaded into general register *rt*. The loaded word is zero-extended.

If either of the two least-significant bits of the effective address is non-zero, an address error exception occurs.

This operation is only defined for the VR4102 operating in 64-bit mode. Execution of this instruction in 32-bit user or supervisor mode causes a reserved instruction exception.

Operation:

```

32  T:  vAddr <- ((offset15)16 || offset15...0) + GPR [base]
      (pAddr, uncached) <- AddressTranslation (vAddr, DATA)
      pAddr <- pAddrPSIZE - 1...3 || (pAddr2...0 xor (ReverseEndian || 02))
      mem <- LoadMemory (uncached, WORD, pAddr, vAddr, DATA)
      byte <- vAddr2...0 xor (BigEndianCPU || 02)
      GPR [rt] <- 032 || mem31 + 8 * byte...8 * byte

64  T:  vAddr <- ((offset15)48 || offset15...0) + GPR [base]
      (pAddr, uncached) <- AddressTranslation (vAddr, DATA)
      pAddr <- pAddrPSIZE - 1...3 || (pAddr2...0 xor (ReverseEndian || 02))
      mem <- LoadMemory (uncached, WORD, pAddr, vAddr, DATA)
      byte <- vAddr2...0 xor (BigEndianCPU || 02)
      GPR [rt] <- 032 || mem31 + 8 * byte...8 * byte

```

Exceptions:

TLB refill exception

TLB invalid exception

Bus error exception

Address error exception

Reserved instruction exception (VR4102 in 32-bit user mode, VR4102 in 32-bit supervisor mode)

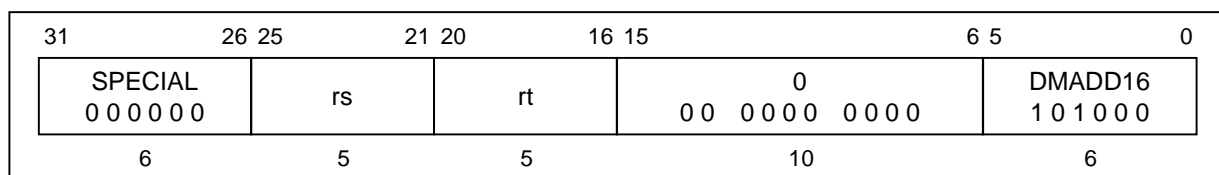
MADD16**Multiply and Add 16-bit integer****MADD16****Format:**

MADD16 rs, rt

Description:

The contents of general registers *rs* and *rt* are multiplied, treating both operands as 16-bit 2's complement values. The operand[62:15] must be valid 15-bit, sign-extended values. If not, the results is unpredictable.

This multiplied result and the 64-bit data joined special register *HI* to *LO* are added to form the result.

No integer overflow exception occurs under any circumstances.

When the operation completes, the low-order word of the double result is loaded into special register *LO*, and the high-order word of the double result is loaded into special register *HI*.

The following Table are hazard cycles between MADD16 and other instructions.

Instruction sequence	No. of cycles
MULT/MULTU -> MADD16	1 Cycle
DMULT/DMULTU -> MADD16	4 Cycles
DIV/DIVU -> MADD16	36 Cycles
DDIV/DDIVU -> MADD16	68 Cycles
MFHI/MFLO -> MADD16	2 Cycles
DMADD16 -> MADD16	0 Cycles
MADD16 -> MADD16	0 Cycles

Operation:

```

32, 64 T:  temp1<- GPR [rs] * GPR [rt]
           temp2<- temp1 + (HI31...0 || LO31...0)
           LO  <- (temp131)32 || temp231...0
           HI  <- (temp263)32 || temp263...32

```

Exceptions:

None

MFC0 Move From System Control Coprocessor MFC0

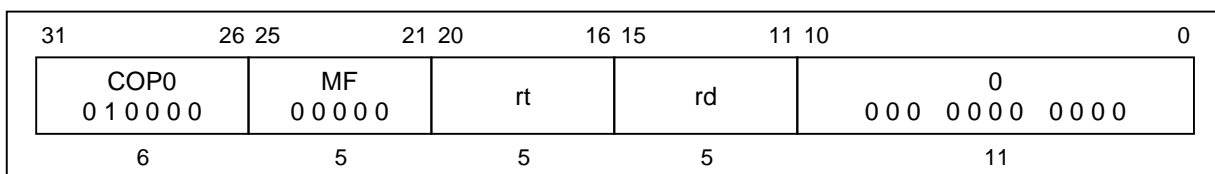
**Format:**

MFC0 rt, rd

Description:

The contents of coprocessor register *rd* of the CP0 are loaded into general register *rt*.

When using a register used by the MFC0 by means of instructions before and after it, refer to Chapter 28 and place the instructions in the appropriate location.

Operation:

32	T: data <- CPR [0, rd]
	T+1: GPR [rt] <- data
64	T: data <- CPR [0, rd]
	T+1: GPR [rt] <- (data ₃₁) ³² data _{31...0}

Exceptions:

Coprocessor unusable exception (user and supervisor mode if CP0 not enabled)

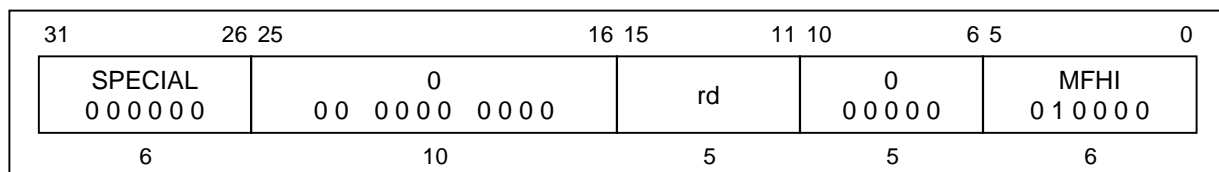
MFHI**Move From HI****MFHI****Format:**

MFHI rd

Description:

The contents of special register *HI* are loaded into general register *rd*.

To ensure proper operation in the event of interruptions, the two instructions which follow a MFHI instruction may not be any of the instructions which modify the *HI* register: MULT, MULTU, DIV, DIVU, MTHI, DMULT, DMULTU, DDIV, DDIVU.

Operation:

32, 64 T: GPR [rd] <- HI

Exceptions:

None

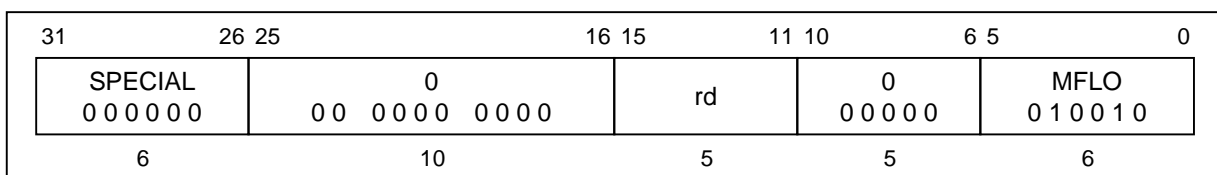
MFLO**Move From LO****MFLO****Format:**

MFLO rd

Description:

The contents of special register *LO* are loaded into general register *rd*.

To ensure proper operation in the event of interruptions, the two instructions which follow a MFLO instruction may not be any of the instructions which modify the *LO* register: MULT, MULTU, DIV, DIVU, MTLO, DMULT, DMULTU, DDIV, DDIVU.

Operation:

32, 64 T: GPR [rd] <- LO

Exceptions:

None

MTC0 Move To Coprocessor0 MTC0

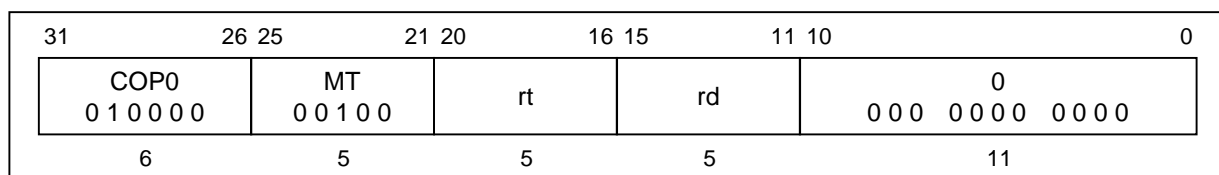
**Format:**MTC0 *rt*, *rd***Description:**

The contents of general register *rt* are loaded into coprocessor register *rd* of coprocessor 0.

Because the state of the virtual address translation system may be altered by this instruction, the operation of load instructions, store instructions, and TLB operations immediately prior to and after this instruction are undefined.

When using a register used by the MTC0 by means of instructions before and after it, refer to Chapter 28 and place the instructions in the appropriate location.

Operation:

32, 64 T: data ← GPR [*rt*]
 T+1: CPR [0, *rd*] ← data

Exceptions:

Coprocessor unusable exception (user and supervisor mode if CP0 not enabled)

MTHI Move To HI MTHI

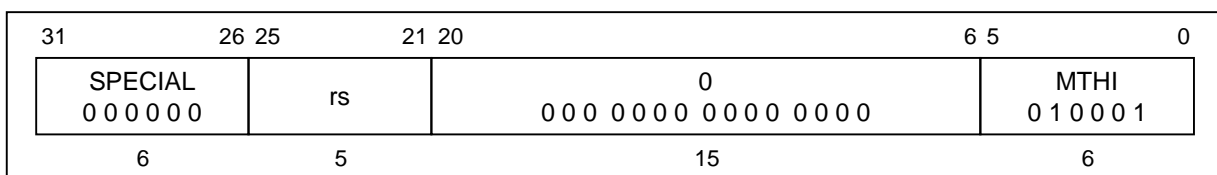
**Format:**

MTHI rs

Description:

The contents of general register *rs* are loaded into special register *HI*.

If a MTHI operation is executed following a MULT, MULTU, DIV, or DIVU instruction, but before any MFLO, MFHI, MTLO, or MTHI instructions, the contents of special register *HI* are undefined.

Operation:

32, 64 T-2: HI <- undefined
 T-1: HI <- undefined
 T: HI <- GPR [rs]

Exceptions:

None

MTLO Move To LO MTLO

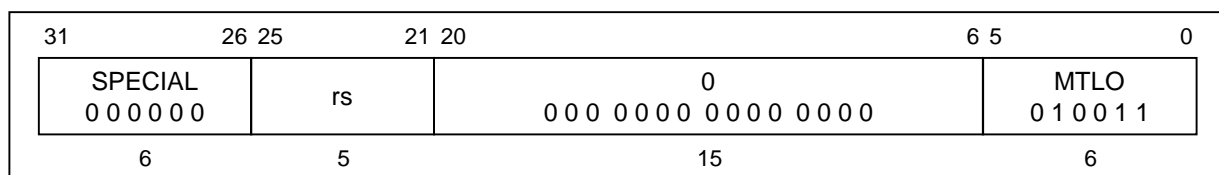
**Format:**

MTLO rs

Description:

The contents of general register *rs* are loaded into special register *LO*.

If an MTLO operation is executed following a MULT, MULTU, DIV, or DIVU instruction, but before any MFLO, MFHI, MTLO, or MTHI instructions, the contents of special register *LO* are undefined.

Operation:

32, 64 T-2: LO <- undefined
 T-1: LO <- undefined
 T: LO <- GPR [rs]

Exceptions:

None

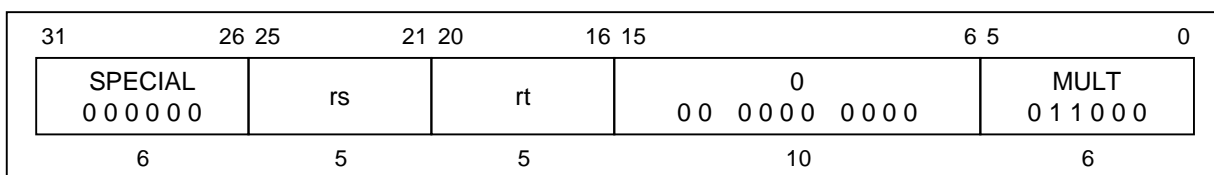
MULT**Multiply****MULT****Format:**

MULT rs, rt

Description:

The contents of general registers *rs* and *rt* are multiplied, treating both operands as 32-bit 2's complement values. No integer overflow exception occurs under any circumstances. In 64-bit mode, the operands must be valid 32-bit, sign-extended values.

When the operation completes, the low-order word of the double result is loaded into special register *LO*, and the high-order word of the double result is loaded into special register *HI*.

If either of the two preceding instructions is MFHI or MFLO, the results of these instructions are undefined. Correct operation requires separating reads of *HI* or *LO* from writes by a minimum of two other instructions.

Operation:

32	T-2:	LO	<- undefined
		HI	<- undefined
	T-1:	LO	<- undefined
		HI	<- undefined
	T:	t	<- GPR [rs] * GPR [rt]
		LO	<- t _{31...0}
		HI	<- t _{63...32}
64	T-2:	LO	<- undefined
		HI	<- undefined
	T-1:	LO	<- undefined
		HI	<- undefined
	T:	t	<- GPR [rs] _{31...0} * GPR [rt] _{31...0}
		LO	<- (t ₃₁) ³² t _{31...0}
		HI	<- (t ₆₃) ³² t _{63...32}

Exceptions:

None

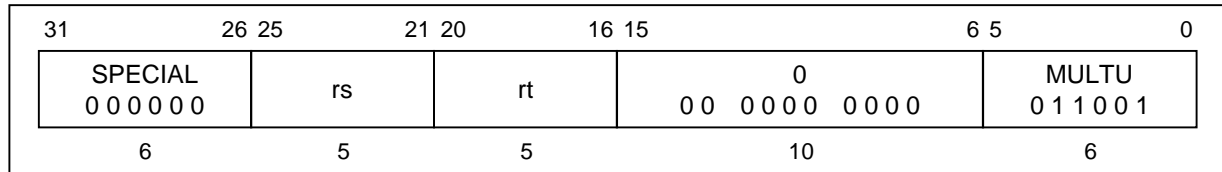
MULTU**Multiply Unsigned****MULTU****Format:**

MULTU rs, rt

Description:

The contents of general register *rs* and the contents of general register *rt* are multiplied, treating both operands as unsigned values. No overflow exception occurs under any circumstances. In 64-bit mode, the operands must be valid 32-bit, sign-extended values.

When the operation completes, the low-order word of the double result is loaded into special register *LO*, and the high-order word of the double result is loaded into special register *HI*.

If either of the two preceding instructions is MFHI or MFLO, the results of these instructions are undefined. Correct operation requires separating reads of *HI* or *LO* from writes by a minimum of two instructions.

Operation:

32	T-2:	LO	<- undefined
		HI	<- undefined
	T-1:	LO	<- undefined
		HI	<- undefined
	T:	t	<- (0 GPR [rs]) * (0 GPR [rt])
		LO	<- t _{31...0}
		HI	<- t _{63...32}
64	T-2:	LO	<- undefined
		HI	<- undefined
	T-1:	LO	<- undefined
		HI	<- undefined
	T:	t	<- (0 GPR [rs] _{31...0}) * (0 GPR [rt] _{31...0})
		LO	<- (t ₃₁) ³² t _{31...0}
		HI	<- (t ₆₃) ³² t _{63...32}

Exceptions:

None

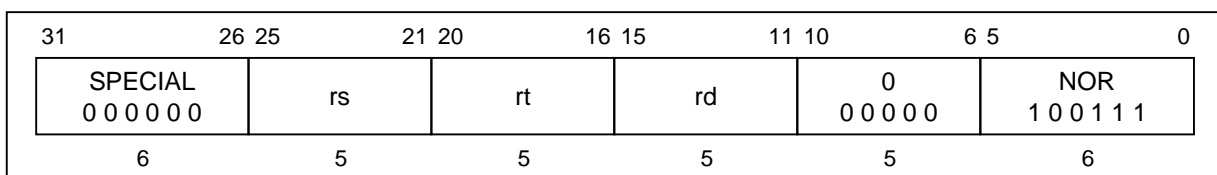
NOR**Nor****NOR****Format:**

NOR rd, rs, rt

Description:

The contents of general register *rs* are combined with the contents of general register *rt* in a bit-wise logical NOR operation. The result is placed into general register *rd*.

Operation:

32, 64 T: GPR [rd] <- GPR [rs] nor GPR [rt]

Exceptions:

None

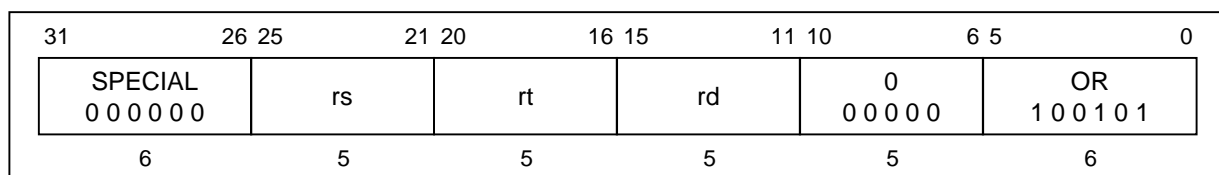
OR**Or****OR****Format:**

OR rd, rs, rt

Description:

The contents of general register *rs* are combined with the contents of general register *rt* in a bit-wise logical OR operation. The result is placed into general register *rd*.

Operation:

32, 64 T: GPR [rd] <- GPR [rs] or GPR [rt]
--

Exceptions:

None

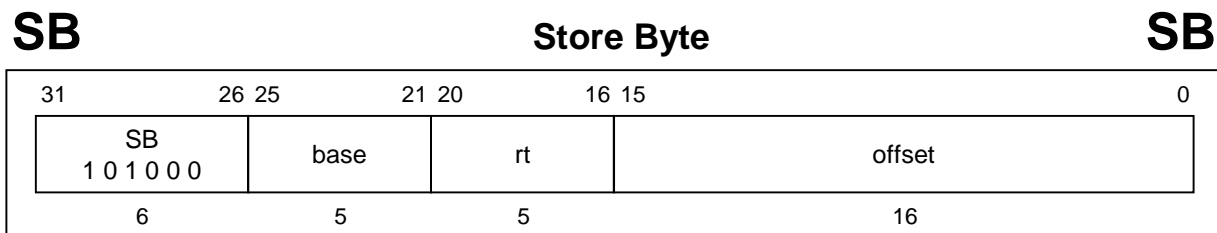
**Format:**

SB rt, offset (base)

Description:

The 16-bit *offset* is sign-extended and added to the contents of general register *base* to form a virtual address. The least-significant byte of register *rt* is stored at the effective address.

Operation:

```

32  T:  vAddr <- ((offset15)16 || offset15...0) + GPR [base]
      (pAddr, uncached) <- AddressTranslation (vAddr, DATA)
      pAddr <- pAddrPSIZE - 1...3 || (pAddr2...0 xor (ReverseEndian3))
      byte <- vAddr2...0 xor BigEndianCPU3
      data <- GPR [rt]63 - 8 * byte...0 || 08 * byte
      StoreMemory (uncached, BYTE, data, pAddr, vAddr, DATA)

64  T:  vAddr <- ((offset15)48 || offset15...0) + GPR [base]
      (pAddr, uncached) <- AddressTranslation (vAddr, DATA)
      pAddr <- pAddrPSIZE - 1...3 || (pAddr2...0 xor (ReverseEndian3))
      byte <- vAddr2...0 xor BigEndianCPU3
      data <- GPR [rt]63 - 8 * byte...0 || 08 * byte
      StoreMemory (uncached, BYTE, data, pAddr, vAddr, DATA)

```

Exceptions:

- TLB refill exception
- TLB invalid exception
- TLB modification exception
- Bus error exception
- Address error exception

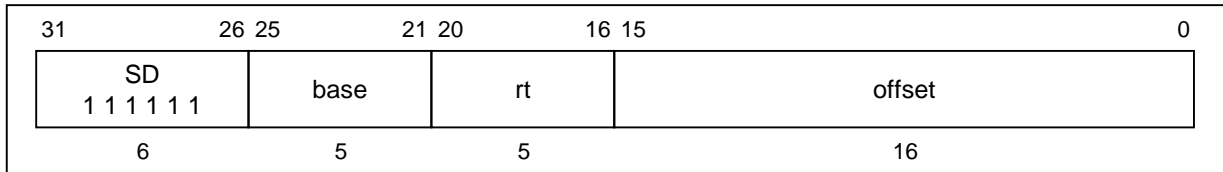
SD**Store Doubleword****SD****Format:**SD *rt*, *offset* (*base*)**Description:**

The 16-bit *offset* is sign-extended and added to the contents of general register *base* to form a virtual address. The contents of general register *rt* are stored at the memory location specified by the effective address.

If either of the three least-significant bits of the effective address are non-zero, an address error exception occurs.

This operation is only defined for the VR4102 operating in 64-bit mode. Execution of this instruction in 32-bit user or supervisor mode causes a reserved instruction exception.

Operation:

```

64 T:  vAddr <- ((offset15)48 || offset15...0) + GPR [base]
      (pAddr, uncached) <- AddressTranslation (vAddr, DATA)
      data <- GPR [rt]
      StoreMemory (uncached, DOUBLEWORD, data, pAddr, vAddr, DATA)

```

Exceptions:

TLB refill exception

TLB invalid exception

TLB modification exception

Bus error exception

Address error exception

Reserved instruction exception (VR4102 in 32-bit user mode, VR4102 in 32-bit supervisor mode)

SDL**Store Doubleword Left
(Continued)****SDL**

This operation is only defined for the VR4102 operating in 64-bit mode. Execution of this instruction in 32-bit user or supervisor mode causes a reserved instruction exception.

Operation:

```

64  T:  vAddr <- ((offset15)48 || offset15...0) + GPR [base]
      (pAddr, uncached) <- AddressTranslation (vAddr, DATA)
      pAddr <- pAddrPSIZE - 1...3 || (pAddr2...0 xor ReverseEndian3)
      if BigEndianMem = 0 then
          pAddr <- pAddrPSIZE - 1...3 || 03
      endif
      byte <- vAddr2...0 xor BigEndianCPU3
      data <- 056 - 8 * byte || GPR [rt]63...56 - 8 * byte
      Storememory (uncached, byte, data, pAddr, vAddr, DATA)

```

SDL**Store Doubleword Left
(Continued)****SDL**

Given a doubleword in a register and a doubleword in memory, the operation of SDL is as follows:

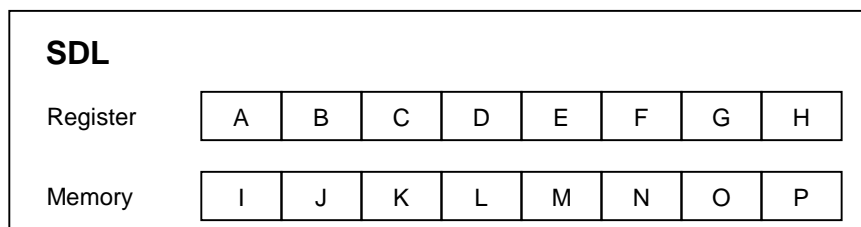

vAddr _{2..0}	BigEndianCPU = 0		
	destination	type	offset (LEM)
0	I J K L M N O A	0	0
1	I J K L M N A B	1	0
2	I J K L M A B C	2	0
3	I J K L A B C D	3	0
4	I J K A B C D E	4	0
5	I J A B C D E F	5	0
6	I A B C D E F G	6	0
7	A B C D E F G H	7	0

LEM Little-endian memory (BigEndianMem = 0)

Type AccessType (see Table 3-2) sent to memory

Offset pAddr_{2..0} sent to memory

Exceptions:

TLB refill exception

TLB invalid exception

TLB modification exception

Bus error exception

Address error exception

Reserved instruction exception (VR4102 in 32-bit user mode, VR4102 in 32-bit supervisor mode)

SDR**Store Doubleword Right
(Continued)****SDR**

This operation is only defined for the VR4102 operating in 64-bit mode. Execution of this instruction in 32-bit user or supervisor mode causes a reserved instruction exception.

Operation:

```

64  T:  vAddr <- ((offset15)48 || offset15...0) + GPR [base]
      (pAddr, uncached) <- AddressTranslation (vAddr, DATA)
      pAddr <- pAddrPSIZE - 1...3 || (pAddr2...0 xor ReverseEndian3)
      if BigEndianMem = 0 then
          pAddr <- pAddrPSIZE - 1...3 || 03
      endif
      byte <- vAddr2...0 xor BigEndianCPU3
      data <- GPR [rt]63 - 8 * byte || 08 * byte
      StoreMemory (uncached, DOUBLEWORD-byte, data, pAddr, vAddr, DATA)

```

SDR**Store Doubleword Right
(Continued)****SDR**

Given a doubleword in a register and a doubleword in memory, the operation of SDR is as follows:

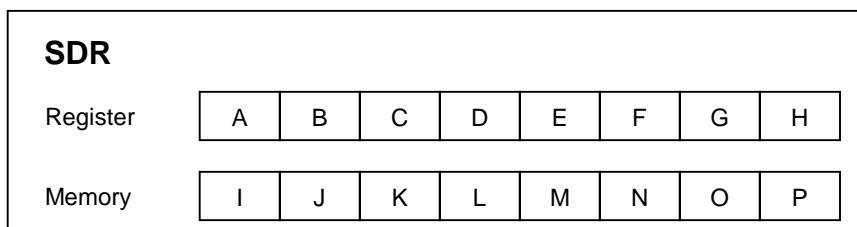

vAddr _{2..0}	BigEndianCPU = 0		
	destination	type	offset (LEM)
0	A B C D E F G H	7	0
1	B C D E F G H P	6	1
2	C D E F G H O P	5	2
3	D E F G H N O P	4	3
4	E F G H M N O P	3	4
5	F G H L M N O P	2	5
6	G H K L M N O P	1	6
7	H J K L M N O P	0	7

LEM Little-endian memory (BigEndianMem = 0)

Type AccessType (see Table 2-2) sent to memory

Offset pAddr_{2..0} sent to memory

Exceptions:

TLB refill exception

TLB invalid exception

TLB modification exception

Bus error exception

Address error exception

Reserved instruction exception (VR4102 in 32-bit user mode, VR4102 in 32-bit supervisor mode)

SH Store Halfword SH

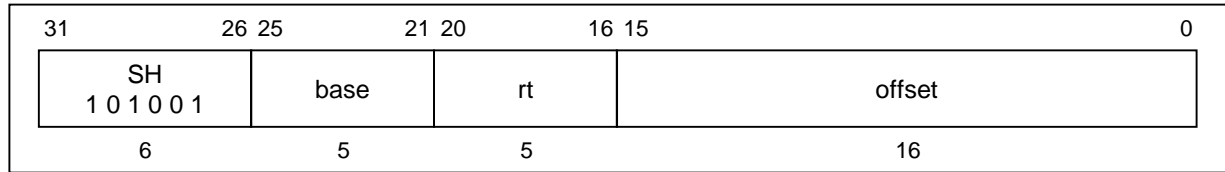
**Format:**SH *rt*, *offset* (*base*)**Description:**

The 16-bit *offset* is sign-extended and added to the contents of general register *base* to form an unsigned effective address. The least-significant halfword of register *rt* is stored at the effective address. If the least-significant bit of the effective address is non-zero, an address error exception occurs.

Operation:

```

32  T:  vAddr <- ((offset15)16 || offset15...0) + GPR [base]
      (pAddr, uncached) <- AddressTranslation (vAddr, DATA)
      pAddr <- pAddrPSIZE - 1...3 || (pAddr2...0 xor (ReverseEndian2 || 0))
      byte <- vAddr2...0 xor (BigEndianCPU2 || 0)
      data <- GPR [rt]63 - 8 * byte...0 || 08 * byte
      StoreMemory (uncached, HALFWORD, data, pAddr, vAddr, DATA)

64  T:  vAddr <- ((offset15)48 || offset15...0) + GPR [base]
      (pAddr, uncached) <- AddressTranslation (vAddr, DATA)
      pAddr <- pAddrPSIZE - 1...3 || (pAddr2...0 xor (ReverseEndian2 || 0))
      byte <- vAddr2...0 xor (BigEndianCPU2 || 0)
      data <- GPR [rt]63 - 8 * byte...0 || 08 * byte
      StoreMemory (uncached, HALFWORD, data, pAddr, vAddr, DATA)

```

Exceptions:

- TLB refill exception
- TLB invalid exception
- TLB modification exception
- Bus error exception
- Address error exception

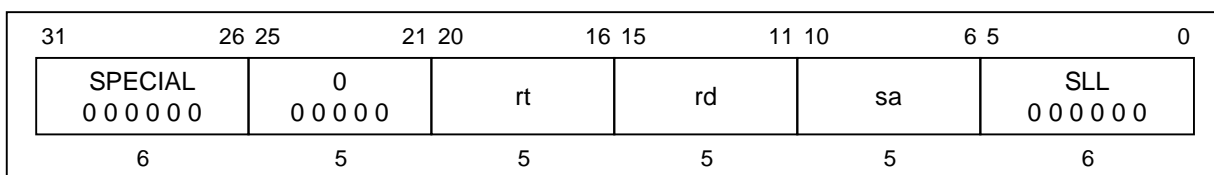
SLL**Shift Left Logical****SLL****Format:**

SLL rd, rt, sa

Description:

The contents of general register *rt* are shifted left by *sa* bits, inserting zeros into the low-order bits.

The result is placed in register *rd*.

In 64-bit mode, the 32-bit result is sign-extended when placed in the destination register. It is sign extended for all shift amounts, including zero; SLL with zero shift amount truncates a 64-bit value to 32 bits and then sign extends this 32-bit value. SLL, unlike nearly all other word operations, does not require an operand to be a properly sign-extended word value to produce a valid sign-extended word result.

Operation:

32	T:	$GPR [rd] \leftarrow GPR [rt]_{31-sa..0} \parallel 0^{sa}$
64	T:	$s \leftarrow 0 \parallel sa$ $temp \leftarrow GPR [rt]_{31-s..0} \parallel 0^s$ $GPR [rd] \leftarrow (temp_{31})^{32} \parallel temp$

Exceptions:

None

Remark SLL with a shift amount of zero may be treated as a NOP by some assemblers, at some optimization levels. If using SLL with a zero shift to truncate 64-bit values, check the assembler you are using.

SLLV Shift Left Logical Variable SLLV

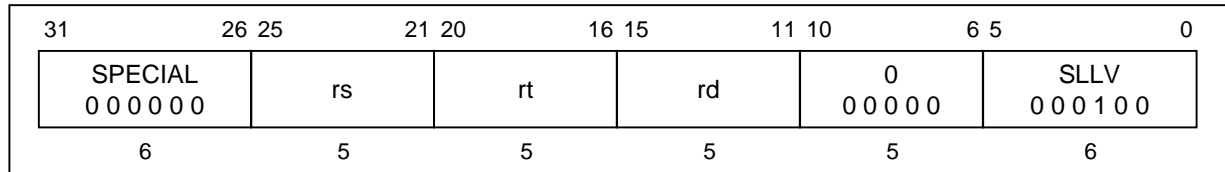
**Format:**

SLLV rd, rt, rs

Description:

The contents of general register *rt* are shifted left the number of bits specified by the low-order five bits contained in general register *rs*, inserting zeros into the low-order bits.

The result is placed in register *rd*.

In 64-bit mode, the 32-bit result is sign-extended when placed in the destination register. It is sign extended for all shift amounts, including zero; SLLV with zero shift amount truncates a 64-bit value to 32 bits and then sign extends this 32-bit value. SLLV, unlike nearly all other word operations, does not require an operand to be a properly sign-extended word value to produce a valid sign-extended word result.

Operation:

32	T:	$s \leftarrow \text{GPR}[rs]_{4..0}$ $\text{GPR}[rd] \leftarrow \text{GPR}[rt]_{(31-s)..0} \parallel 0^s$
64	T:	$s \leftarrow 0 \parallel \text{GPR}[rs]_{4..0}$ $\text{temp} \leftarrow \text{GPR}[rt]_{(31-s)..0} \parallel 0^s$ $\text{GPR}[rd] \leftarrow (\text{temp}_{31})^{32} \parallel \text{temp}$

Exceptions:

None

Remark SLLV with a shift amount of zero may be treated as a NOP by some assemblers, at some optimization levels. If using SLLV with a zero shift to truncate 64-bit values, check the assembler you are using.

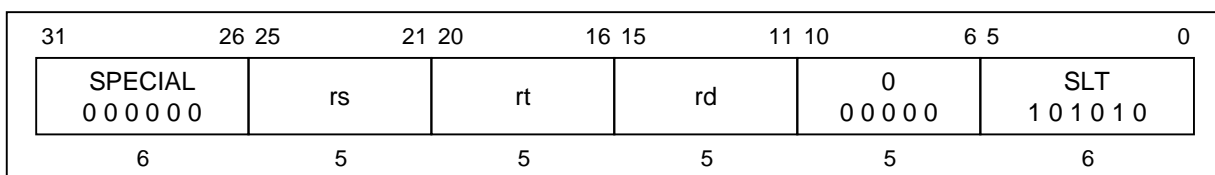
SLT**Set On Less Than****SLT****Format:**

SLT rd, rs, rt

Description:

The contents of general register *rt* are subtracted from the contents of general register *rs*. Considering both quantities as signed integers, if the contents of general register *rs* are less than the contents of general register *rt*, the result is set to one; otherwise the result is set to zero.

The result is placed into general register *rd*.

No integer overflow exception occurs under any circumstances. The comparison is valid even if the subtraction used during the comparison overflows.

Operation:

```

32  T:  if GPR [rs] < GPR [rt] then
        GPR [rd] <- 031 || 1
    else
        GPR [rd] <- 032
    endif

64  T:  if GPR [rs] < GPR [rt] then
        GPR [rd] <- 063 || 1
    else
        GPR [rd] <- 064
    endif

```

Exceptions:

None

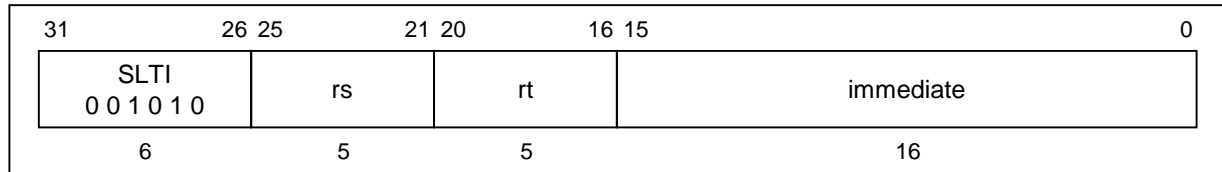
SLTI**Set On Less Than Immediate****SLTI****Format:**

SLTI rt, rs, immediate

Description:

The 16-bit *immediate* is sign-extended and subtracted from the contents of general register *rs*. Considering both quantities as signed integers, if *rs* is less than the sign-extended immediate, the result is set to one; otherwise the result is set to zero.

The result is placed into general register *rt*.

No integer overflow exception occurs under any circumstances. The comparison is valid even if the subtraction used during the comparison overflows.

Operation:

```

32  T:  if GPR [rs] < (immediate15)16 || immediate15...0 then
        GPR [rt] <- 031 || 1
    else
        GPR [rt] <- 032
    endif

64  T:  if GPR [rs] < (immediate15)48 || immediate15...0 then
        GPR [rt] <- 063 || 1
    else
        GPR [rt] <- 064
    endif

```

Exceptions:

None

SLTIU Set On Less Than Immediate Unsigned SLTIU

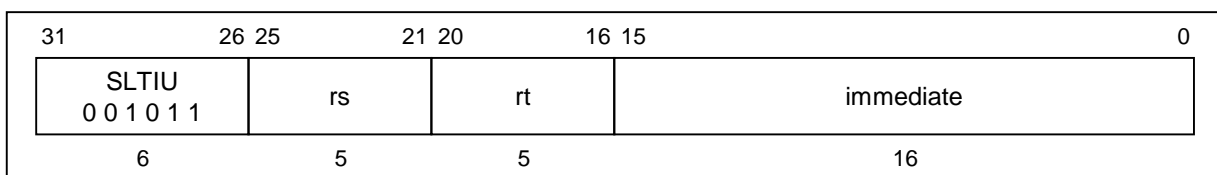
**Format:**

SLTIU rt, rs, immediate

Description:

The 16-bit *immediate* is sign-extended and subtracted from the contents of general register *rs*. Considering both quantities as unsigned integers, if *rs* is less than the sign-extended immediate, the result is set to one; otherwise the result is set to zero.

The result is placed into general register *rt*.

No integer overflow exception occurs under any circumstances. The comparison is valid even if the subtraction used during the comparison overflows.

Operation:

```

32  T:  if (0 || GPR [rs]) < (0 || (immediate15)16 || immediate15...0) then
        GPR [rt] <- 031 || 1
    else
        GPR [rt] <- 032
    endif

64  T:  if (0 || GPR [rs]) < (0 || (immediate15)48 || immediate15...0) then
        GPR [rt] <- 063 || 1
    else
        GPR [rt] <- 064
    endif

```

Exceptions:

None

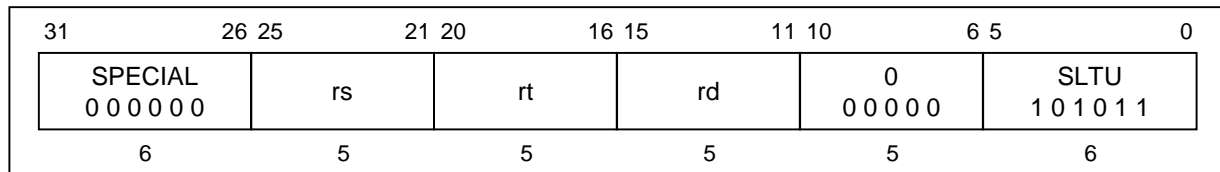
SLTU**Set On Less Than Unsigned****SLTU****Format:**

SLTU rd, rs, rt

Description:

The contents of general register *rt* are subtracted from the contents of general register *rs*. Considering both quantities as unsigned integers, if the contents of general register *rs* are less than the contents of general register *rt*, the result is set to one; otherwise the result is set to zero.

The result is placed into general register *rd*.

No integer overflow exception occurs under any circumstances. The comparison is valid even if the subtraction used during the comparison overflows.

Operation:

```

32  T:  if (0 || GPR [rs]) < 0 || GPR [rt] then
        GPR [rd] <- 031 || 1
        else
        GPR [rd] <- 032
        endif

64  T:  if (0 || GPR [rs]) < 0 || GPR [rt] then
        GPR [rd] <- 063 || 1
        else
        GPR [rd] <- 064
        endif

```

Exceptions:

None

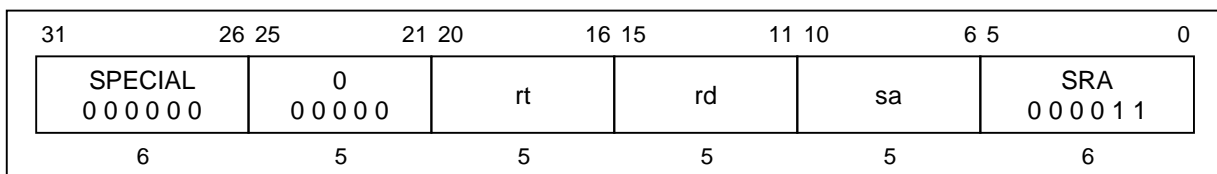
SRA**Shift Right Arithmetic****SRA****Format:**

SRA rd, rt, sa

Description:

The contents of general register *rt* are shifted right by *sa* bits, sign-extending the high-order bits.

The result is placed in register *rd*.

In 64-bit mode, the operand must be a valid sign-extended, 32-bit value.

Operation:

32 T: $GPR[rd] \leftarrow (GPR[rt]_{31})^{sa} \parallel GPR[rt]_{31...sa}$

64 T: $s \leftarrow 0 \parallel sa$
 $temp \leftarrow (GPR[rt]_{31})^s \parallel GPR[rt]_{31...s}$
 $GPR[rd] \leftarrow (temp_{31})^{32} \parallel temp$

Exceptions:

None

SRAV Shift Right Arithmetic Variable SRAV

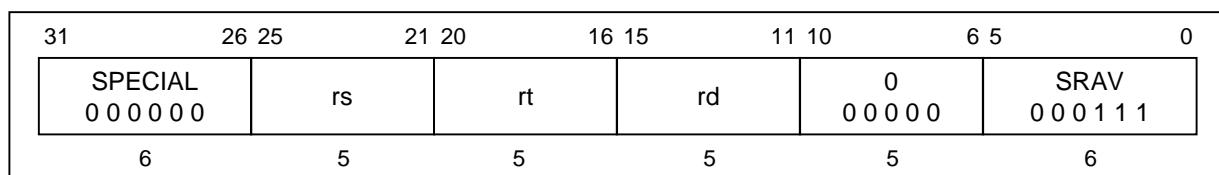
**Format:**

SRAV rd, rt, rs

Description:

The contents of general register *rt* are shifted right by the number of bits specified by the low-order five bits of general register *rs*, sign-extending the high-order bits.

The result is placed in register *rd*.

In 64-bit mode, the operand must be a valid sign-extended, 32-bit value.

Operation:

32	T: s <- GPR [rs] _{4...0} GPR [rd] <- (GPR [rt] ₃₁) ^s GPR [rt] _{31...s}
64	T: s <- GPR [rs] _{4...0} temp <- (GPR [rt] ₃₁) ^s GPR [rt] _{31...s} GPR [rd] <- (temp ₃₁) ³² temp

Exceptions:

None

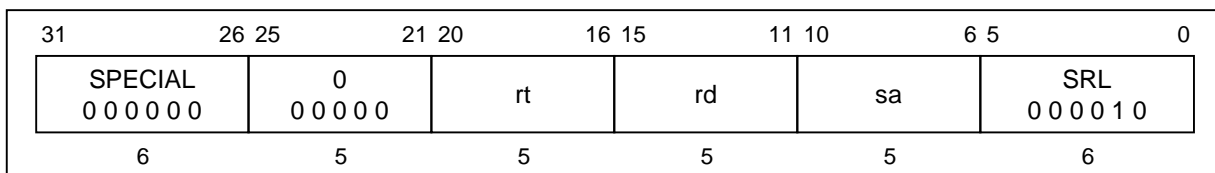
SRL**Shift Right Logical****SRL****Format:**

SRL rd, rt, sa

Description:

The contents of general register *rt* are shifted right by *sa* bits, inserting zeros into the high-order bits.

The result is placed in register *rd*.

In 64-bit mode, the operand must be a valid sign-extended, 32-bit value.

Operation:

32 T: $\text{GPR}[\text{rd}] \leftarrow 0^{\text{sa}} \parallel \text{GPR}[\text{rt}]_{31:\text{sa}}$

64 T: $s \leftarrow 0 \parallel \text{sa}$
 $\text{temp} \leftarrow 0^s \parallel \text{GPR}[\text{rt}]_{31:s}$
 $\text{GPR}[\text{rd}] \leftarrow (\text{temp}_{31})^{32} \parallel \text{temp}$

Exceptions:

None

SRLV Shift Right Logical Variable SRLV

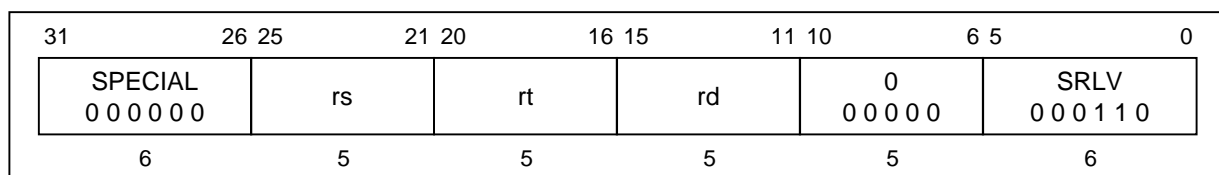
**Format:**

SRLV rd, rt, rs

Description:

The contents of general register *rt* are shifted right by the number of bits specified by the low-order five bits of general register *rs*, inserting zeros into the high-order bits.

The result is placed in register *rd*.

In 64-bit mode, the operand must be a valid sign-extended, 32-bit value.

Operation:

32	T: s <- GPR [rs] _{4...0} GPR [rd] <- 0 ^s GPR [rt] _{31...s}
64	T: s <- GPR [rs] _{4...0} temp <- 0 ^s GPR [rt] _{31...s} GPR [rd] <- (temp ₃₁) ³² temp

Exceptions:

None

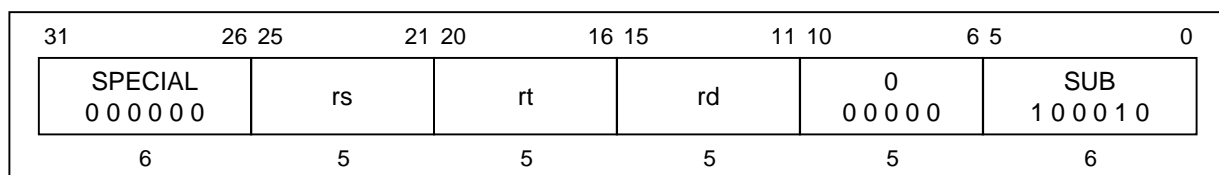
SUB**Subtract****SUB****Format:**

SUB rd, rs, rt

Description:

The contents of general register *rt* are subtracted from the contents of general register *rs* to form a result. The result is placed into general register *rd*. In 64-bit mode, the operands must be valid sign-extended, 32-bit values.

The only difference between this instruction and the SUBU instruction is that SUBU never traps on overflow.

An integer overflow exception takes place if the carries out of bits 30 and 31 differ (2's complement overflow). The destination register *rd* is not modified when an integer overflow exception occurs.

Operation:

32	T:	GPR [rd] <- GPR [rs] - GPR [rt]
64	T:	temp <- GPR [rs] - GPR [rt] GPR [rd] <- (temp ₃₁) ³² temp _{31...0}

Exceptions:

Integer overflow exception

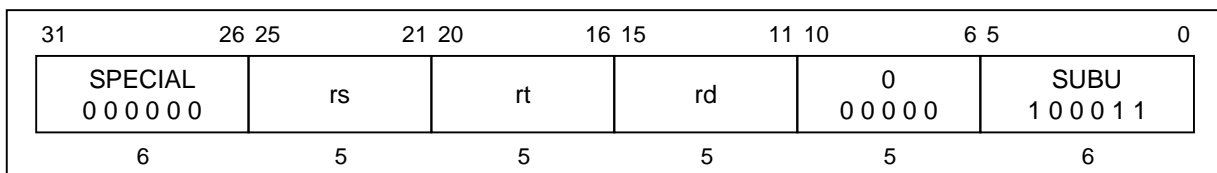
SUBU**Subtract Unsigned****SUBU****Format:**

SUBU rd, rs, rt

Description:

The contents of general register *rt* are subtracted from the contents of general register *rs* to form a result.

The result is placed into general register *rd*.

In 64-bit mode, the operands must be valid sign-extended, 32-bit values.

The only difference between this instruction and the SUB instruction is that SUBU never traps on overflow. No integer overflow exception occurs under any circumstances.

Operation:

32	T:	GPR [rd] <- GPR [rs] - GPR [rt]
64	T:	temp <- GPR [rs] - GPR [rt] GPR [rd] <- (temp ₃₁) ³² temp _{31...0}

Exceptions:

None

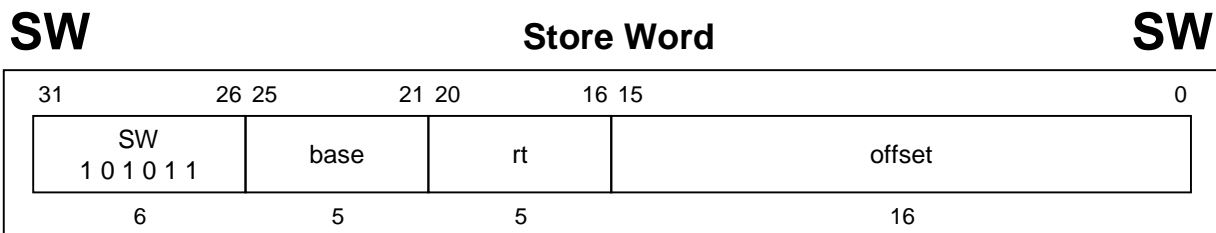
**Format:**

SW rt, offset (base)

Description:

The 16-bit *offset* is sign-extended and added to the contents of general register *base* to form a virtual address. The contents of general register *rt* are stored at the memory location specified by the effective address.

If either of the two least-significant bits of the effective address are non-zero, an address error exception occurs.

Operation:

```

32  T:  vAddr <- ((offset15)16 || offset15...0) + GPR [base]
      (pAddr, uncached) <- AddressTranslation (vAddr, DATA)
      pAddr <- pAddrPSIZE - 1...3 || (pAddr2...0 xor (ReverseEndian || 02))
      byte <- vAddr2...0 xor (BigEndianCPU || 02)
      data <- GPR [rt]63 - 8 * byte || 08 * byte
      StoreMemory (uncached, WORD, data, pAddr, vAddr, DATA)

64  T:  vAddr <- ((offset15)48 || offset15...0) + GPR [base]
      (pAddr, uncached) <- AddressTranslation (vAddr, DATA)
      pAddr <- pAddrPSIZE - 1...3 || (pAddr2...0 xor (ReverseEndian || 02))
      byte <- vAddr2...0 xor (BigEndianCPU || 02)
      data <- GPR [rt]63 - 8 * byte || 08 * byte
      StoreMemory (uncached, WORD, data, pAddr, vAddr, DATA)

```

Exceptions:

- TLB refill exception
- TLB invalid exception
- TLB modification exception
- Bus error exception
- Address error exception

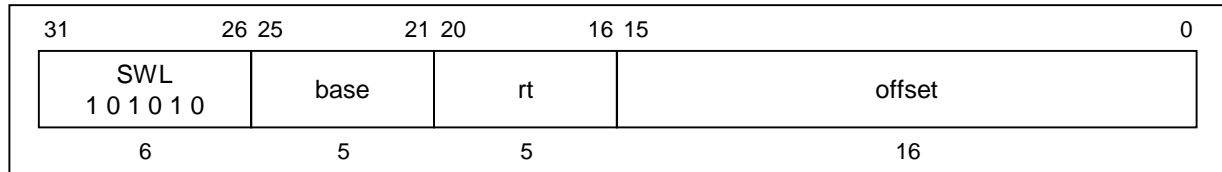
SWL**Store Word Left****SWL****Format:**SWL *rt*, *offset* (*base*)**Description:**

This instruction can be used with the SWR instruction to store the contents of a register into four consecutive bytes of memory, when the bytes cross a word boundary. SWL stores the left portion of the register into the appropriate part of the high-order word of memory; SWR stores the right portion of the register into the appropriate part of the low-order word.

The SWL instruction adds its sign-extended 16-bit *offset* to the contents of general register *base* to form a virtual address which may specify an arbitrary byte. It alters only the word in memory which contains that byte. From one to four bytes will be stored, depending on the starting byte specified.

Conceptually, it starts at the most-significant byte of the register and copies it to the specified byte in memory; then it copies bytes from register to memory until it reaches the low-order byte of the word in memory.

No address error exceptions due to alignment are possible.

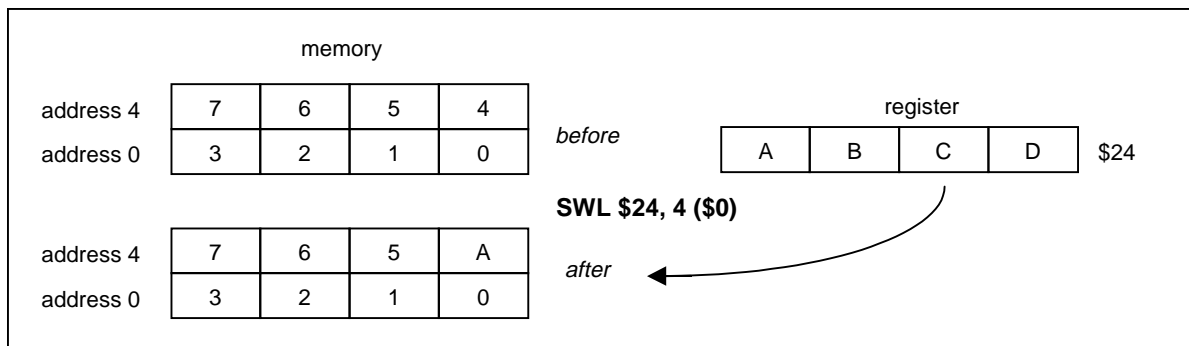

SWL

Store Word Left
(Continued)

SWL

Operation:

```

32  T:  vAddr <- ((offset15)16 || offset15...0) + GPR [base]
      (pAddr, uncached) <- AddressTranslation (vAddr, DATA)
      pAddr <- pAddrPSIZE - 1...3 || (pAddr2...0 xor ReverseEndian3)
      if BigEndianMem = 0 then
        pAddr <- pAddrPSIZE - 1...2 || 02
      endif
      byte <- vAddr1...0 xor BigEndianCPU2
      if (vAddr2 xor BigEndianCPU) = 0 then
        data <- 032 || 024 - 8 * byte || GPR [rt]31...24 - 8 * byte
      else
        data <- 024 - 8 * byte || GPR [rt]31...24 - 8 * byte || 032
      endif
      StoreMemory (uncached, byte, data, pAddr, vAddr, DATA)

64  T:  vAddr <- ((offset15)48 || offset15...0) + GPR [base]
      (pAddr, uncached) <- AddressTranslation (vAddr, DATA)
      pAddr <- pAddrPSIZE - 1...3 || (pAddr2...0 xor ReverseEndian3)
      if BigEndianMem = 0 then
        pAddr <- pAddrPSIZE - 1...2 || 02
      endif
      byte <- vAddr1...0 xor BigEndianCPU2
      if (vAddr2 xor BigEndianCPU) = 0 then
        data <- 032 || 024 - 8 * byte || GPR [rt]31...24 - 8 * byte
      else
        data <- 024 - 8 * byte || GPR [rt]31...24 - 8 * byte || 032
      endif
      StoreMemory (uncached, byte, data, pAddr, vAddr, DATA)

```

SWL

Store Word Left (Continued)

SWL

Given a doubleword in a register and a doubleword in memory, the operation of SWL is as follows:

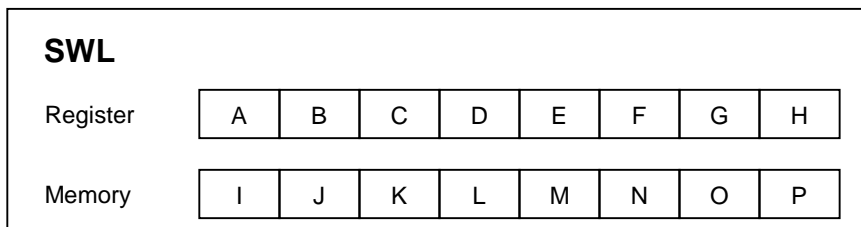

www.DataSheet4U.com

vAddr _{2..0}	BigEndianCPU = 0		
	destination	type	offset (LEM)
0	I J K L M N O E	0	0
1	I J K L M N E F	1	0
2	I J K L M E F G	2	0
3	I J K L E F G H	3	0
4	I J K E M N O P	0	4
5	I J E F M N O P	1	4
6	I E F G M N O P	2	4
7	E F G H M N O P	3	4

- LEM* Little-endian memory (BigEndianMem = 0)
- Type* AccessType (see Table 3-2) sent to memory
- Offset* pAddr_{2..0} sent to memory

Exceptions:

- TLB refill exception
- TLB invalid exception
- TLB modification exception
- Bus error exception
- Address error exception

SWR Store Word Right SWR

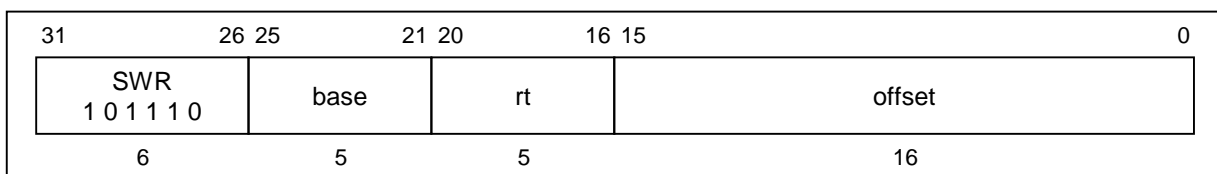
**Format:**SWR *rt*, *offset* (*base*)**Description:**

This instruction can be used with the SWL instruction to store the contents of a register into four consecutive bytes of memory, when the bytes cross a boundary between two words. SWR stores the right portion of the register into the appropriate part of the low-order word; SWL stores the left portion of the register into the appropriate part of the low-order word of memory.

The SWR instruction adds its sign-extended 16-bit *offset* to the contents of general register *base* to form a virtual address which may specify an arbitrary byte. It alters only the word in memory which contains that byte. From one to four bytes will be stored, depending on the starting byte specified.

Conceptually, it starts at the least-significant (rightmost) byte of the register and copies it to the specified byte in memory; then copies bytes from register to memory until it reaches the high-order byte of the word in memory.

No address error exceptions due to alignment are possible.

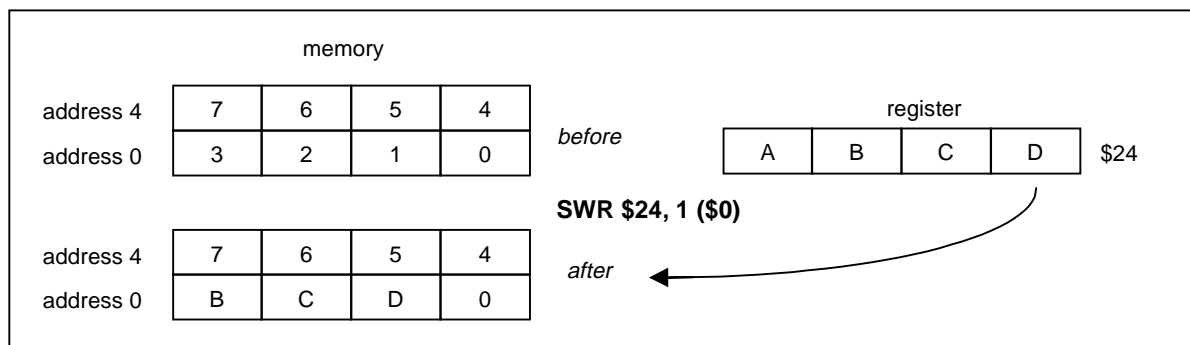

SWR

Store Word Right
(Continued)

SWR

Operation:

```

32  T:  vAddr <- ((offset15)16 || offset15..0) + GPR [base]
      (pAddr, uncached) <- AddressTranslation (vAddr, DATA)
      pAddr <- pAddrPSIZE - 1..3 || (pAddr2..0 xor ReverseEndian3)
      if BigEndianMem = 1 then
          pAddr <- pAddrPSIZE - 1..2 || 02
      endif
      byte <- vAddr1..0 xor BigEndianCPU2
      if (vAddr2 xor BigEndianCPU) = 0 then
          data <- 032 || GPR [rt]31 - 8 * byte..0 || 08 * byte
      else
          data <- GPR [rt]31 - 8 * byte || 08 * byte || 032
      endif
      StoreMemory (uncached, WORD-byte, data, pAddr, vAddr, DATA)

64  T:  vAddr <- ((offset15)48 || offset15..0) + GPR [base]
      (pAddr, uncached) <- AddressTranslation (vAddr, DATA)
      pAddr <- pAddrPSIZE - 1..3 || (pAddr2..0 xor ReverseEndian3)
      if BigEndianMem = 1 then
          pAddr <- pAddrPSIZE - 1..2 || 02
      endif
      byte <- vAddr1..0 xor BigEndianCPU2
      if (vAddr2 xor BigEndianCPU) = 0 then
          data <- 032 || GPR [rt]31 - 8 * byte..0 || 08 * byte
      else
          data <- GPR [rt]31 - 8 * byte || 08 * byte || 032
      endif
      StoreMemory (uncached, WORD-byte, data, pAddr, vAddr, DATA)

```

SWR

**Store Word Right
(Continued)**

SWR

Given a doubleword in a register and a doubleword in memory, the operation of SWR is as follows:

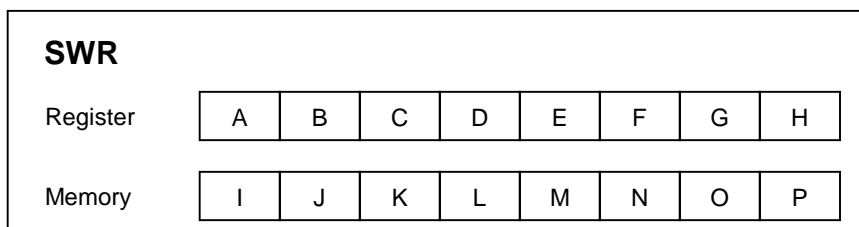

www.DataSheet4U.com

vAddr _{2..0}	BigEndianCPU = 0		
	destination	type	offset (LEM)
0	I J K L E F G H	3	0
1	I J K L F G H P	2	1
2	I J K L G H O P	1	2
3	I J K L H N O P	0	3
4	E F G H M N O P	3	4
5	F G H L M N O P	2	5
6	G H K L M N O P	1	6
7	H J K L M N O P	0	7

- LEM* Little-endian memory (BigEndianMem = 0)
- Type* AccessType (see Table 3-2) sent to memory
- Offset* pAddr_{2..0} sent to memory

Exceptions:

- TLB refill exception
- TLB invalid exception
- TLB modification exception
- Bus error exception
- Address error exception

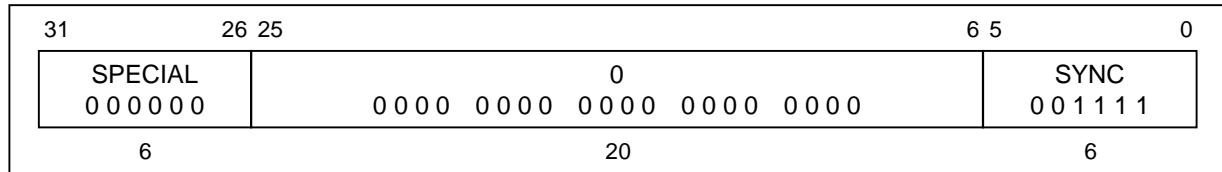
SYNC**Synchronize****SYNC****Format:**

SYNC

Description:

The SYNC instruction is executed as a NOP on the VR4102. This operation maintains compatibility with code compiled for the VR4000 and VR4400.

Operation:

32, 64 T: SyncOperation ()

Exceptions:

None

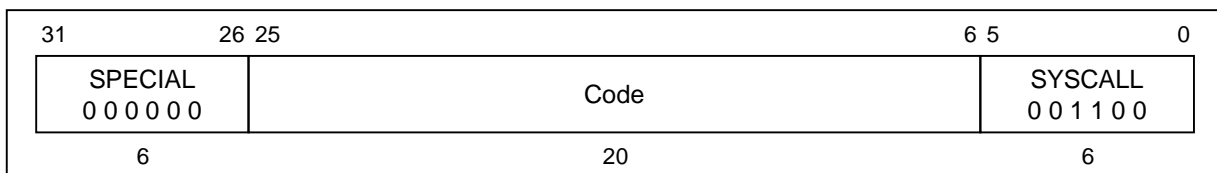
SYSCALL**System Call****SYSCALL****Format:**

SYSCALL

Description:

A system call exception occurs, immediately and unconditionally transferring control to the exception handler.

The code field is available for use as software parameters, but is retrieved by the exception handler only by loading the contents of the memory word containing the instruction.

Operation:

32, 64 T: SystemCallException

Exceptions:

System Call exception

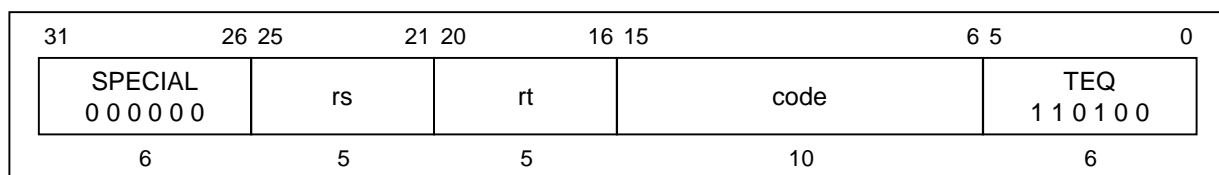
TEQ**Trap If Equal****TEQ****Format:**TEQ *rs*, *rt***Description:**

The contents of general register *rt* are compared to general register *rs*. If the contents of general register *rs* are equal to the contents of general register *rt*, a trap exception occurs.

The code field is available for use as software parameters, but is retrieved by the exception handler only by loading the contents of the memory word containing the instruction.

Operation:

```

32, 64 T:  if GPR [rs] = GPR [rt] then
            TrapException
            endif

```

Exceptions:

Trap exception

TEQI Trap If Equal Immediate TEQI

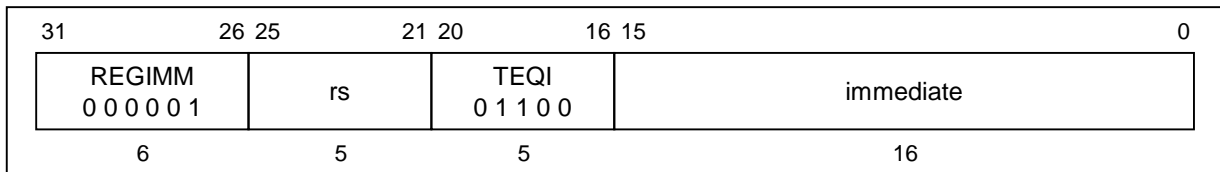
**Format:**

TEQI rs, immediate

Description:

The 16-bit *immediate* is sign-extended and compared to the contents of general register *rs*. If the contents of general register *rs* are equal to the sign-extended *immediate*, a trap exception occurs.

Operation:

```

32  T:  if GPR [rs] = (immediate15)16 || immediate15...0 then
        TrapException
    endif

64  T:  if GPR [rs] = (immediate15)48 || immediate15...0 then
        TrapException
    endif

```

Exceptions:

Trap exception

TGE Trap If Greater Than Or Equal TGE

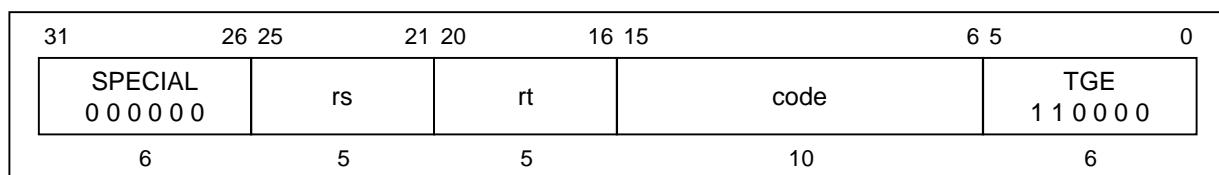
**Format:**TGE *rs*, *rt***Description:**

The contents of general register *rt* are compared to the contents of general register *rs*. Considering both quantities as signed integers, if the contents of general register *rs* are greater than or equal to the contents of general register *rt*, a trap exception occurs.

The code field is available for use as software parameters, but is retrieved by the exception handler only by loading the contents of the memory word containing the instruction.

Operation:

```
32, 64 T:  if GPR [rs] ≥ GPR [rt] then
           TrapException
           endif
```

Exceptions:

Trap exception

TGEIU Trap If Greater Than Or Equal Immediate Unsigned TGEIU

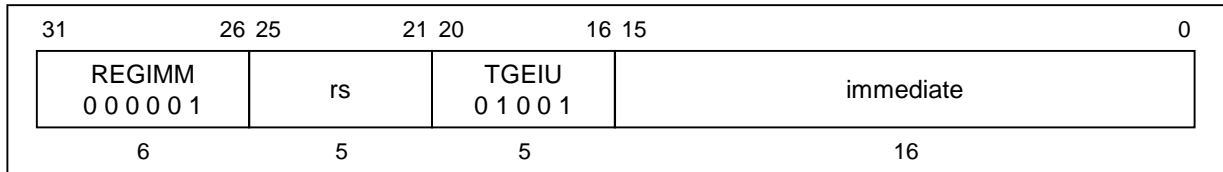
**Format:**

TGEIU rs, immediate

Description:

The 16-bit *immediate* is sign-extended and compared to the contents of general register *rs*. Considering both quantities as unsigned integers, if the contents of general register *rs* are greater than or equal to the sign-extended *immediate*, a trap exception occurs.

Operation:

```

32  T:  if (0 || GPR [rs]) ≥ (0 || (immediate15)16 || immediate15...0) then
        TrapException
        endif

64  T:  if (0 || GPR [rs]) ≥ (0 || (immediate15)48 || immediate15...0) then
        TrapException
        endif

```

Exceptions:

Trap exception

TGEU Trap If Greater Than Or Equal Unsigned TGEU

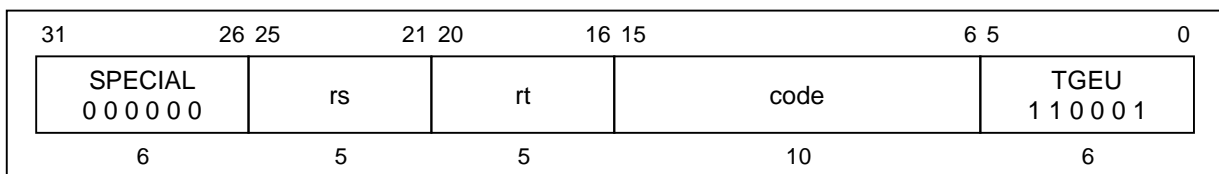
**Format:**

TGEU rs, rt

www.DataSheet4U.com **Description:**

The contents of general register *rt* are compared to the contents of general register *rs*. Considering both quantities as unsigned integers, if the contents of general register *rs* are greater than or equal to the contents of general register *rt*, a trap exception occurs.

The code field is available for use as software parameters, but is retrieved by the exception handler only by loading the contents of the memory word containing the instruction.

Operation:

```
32, 64 T:  if (0 || GPR [rs]) ≥ (0 || GPR [rt]) then
            TrapException
        endif
```

Exceptions:

Trap exception

TLBR

Read Indexed TLB Entry

TLBR

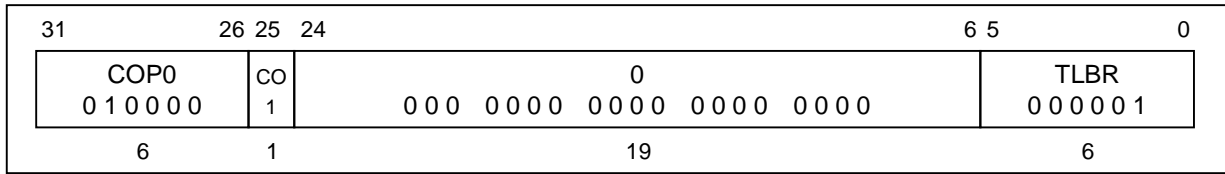

Format:

TLBR

Description:

The G bit (which controls ASID matching) read from the TLB is written into both of the EntryLo0 and EntryLo1 registers.

The EntryHi and EntryLo registers are loaded with the contents of the TLB entry pointed at by the contents of the TLB Index register. The operation is invalid (and the results are unspecified) if the contents of the TLB Index register are greater than the number of TLB entries in the processor.

Operation:

```

32  T:  PageMask <- TLB [Index5...0]127...96
      EntryHi <- TLB [Index5...0]95...64 and not TLB [Index5...0]127...96
      EntryLo1 <- TLB [Index5...0]63...33 || TLB [Index5...0]76
      EntryLo0 <- TLB [Index5...0]31...1 || TLB [Index5...0]76

64  T:  PageMask <- TLB [Index5...0]255...192
      EntryHi <- TLB [Index5...0]191...128 and not TLB [Index5...0]255...192
      EntryLo1 <- TLB [Index5...0]127...65 || TLB [Index5...0]140
      EntryLo0 <- TLB [Index5...0]63...1 || TLB [Index5...0]140
    
```

Exceptions:

Coprocessor unusable exception

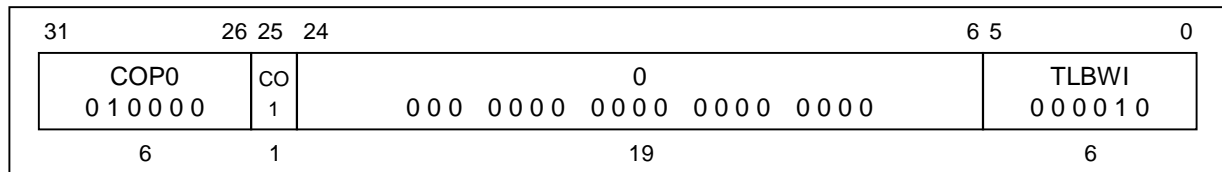
TLBWI**Write Indexed TLB Entry****TLBWI****Format:**

TLBWI

Description:

The TLB entry pointed at by the contents of the TLB Index register is loaded with the contents of the EntryHi and EntryLo registers.

The *G* bit of the TLB is written with the logical AND of the *G* bits in the EntryLo0 and EntryLo1 registers.

The operation is invalid (and the results are unspecified) if the contents of the TLB Index register are greater than the number of TLB entries in the processor.

Operation:

32, 64 T: TLB [Index _{5...0}] ← PageMask (EntryHi and not PageMask) EntryLo1 EntryLo0

Exceptions:

Coprocessor unusable exception

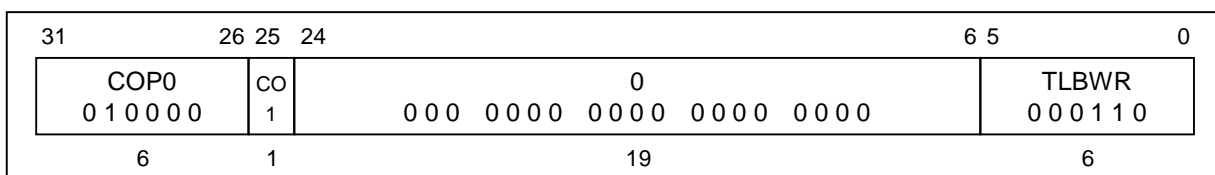
TLBWR**Write Random TLB Entry****TLBWR****Format:**

TLBWR

Description:

The TLB entry pointed at by the contents of the TLB Random register is loaded with the contents of the EntryHi and EntryLo registers.

The *G* bit of the TLB is written with the logical AND of the *G* bits in the EntryLo0 and EntryLo1 registers.

Operation:

32, 64 T: TLB [Random_{5...0}] <-
PageMask || (EntryHi and not PageMask) || EntryLo1 || EntryLo0

Exceptions:

Coprocessor unusable exception

TLT Trap If Less Than TLT

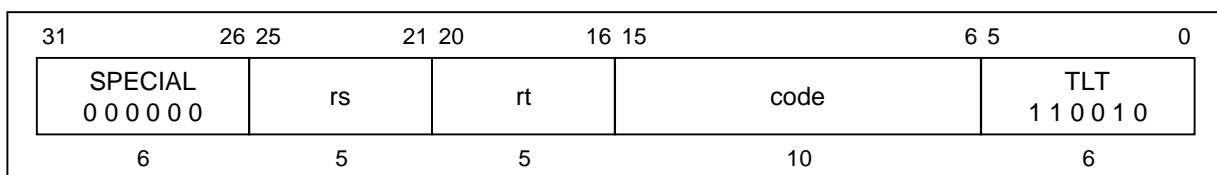
**Format:**

TLT rs, rt

Description:

The contents of general register *rt* are compared to general register *rs*. Considering both quantities as signed integers, if the contents of general register *rs* are less than the contents of general register *rt*, a trap exception occurs.

The code field is available for use as software parameters, but is retrieved by the exception handler only by loading the contents of the memory word containing the instruction.

Operation:

```
32, 64 T:  if GPR [rs] < GPR [rt] then
           TrapException
           endif
```

Exceptions:

Trap exception

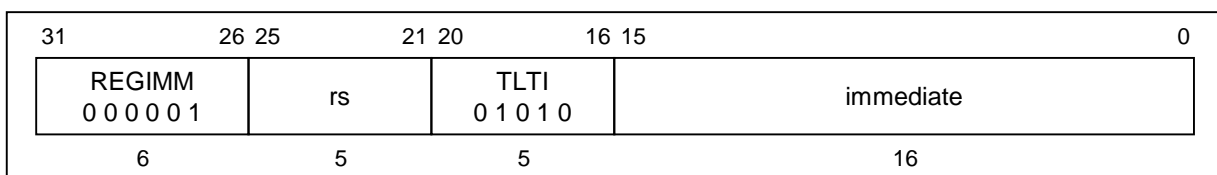
TLTI**Trap If Less Than Immediate****TLTI****Format:**

TLTI rs, immediate

Description:

The 16-bit *immediate* is sign-extended and compared to the contents of general register *rs*. Considering both quantities as signed integers, if the contents of general register *rs* are less than the sign-extended *immediate*, a trap exception occurs.

Operation:

```

32  T:  if GPR [rs] < (immediate15)16 || immediate15...0 then
        TrapException
        endif

64  T:  if GPR [rs] < (immediate15)48 || immediate15...0 then
        TrapException
        endif

```

Exceptions:

Trap exception

TLTIU Trap If Less Than Immediate Unsigned TLTIU

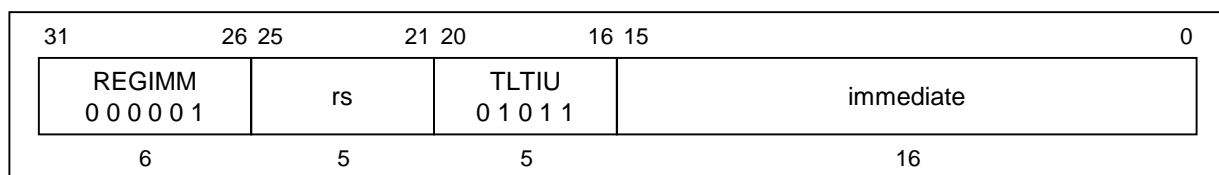
**Format:**

TLTIU rs, immediate

Description:

The 16-bit *immediate* is sign-extended and compared to the contents of general register *rs*. Considering both quantities as unsigned integers, if the contents of general register *rs* are less than the sign-extended *immediate*, a trap exception occurs.

Operation:

```

32  T:  if (0 || GPR [rs]) < (0 || (immediate15)16 || immediate15...0) then
        TrapException
        endif

64  T:  if (0 || GPR [rs]) < (0 || (immediate15)48 || immediate15...0) then
        TrapException
        endif

```

Exceptions:

Trap exception

TLTU Trap If Less Than Unsigned TLTU

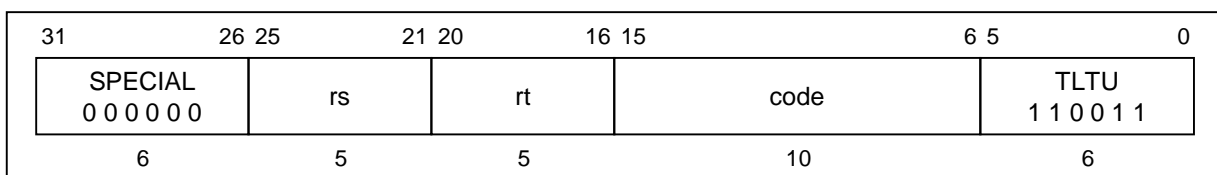
**Format:**

TLTU rs, rt

Description:

The contents of general register *rt* are compared to general register *rs*. Considering both quantities as unsigned integers, if the contents of general register *rs* are less than the contents of general register *rt*, a trap exception occurs.

The code field is available for use as software parameters, but is retrieved by the exception handler only by loading the contents of the memory word containing the instruction.

Operation:

```
32, 64 T:  if (0 || GPR [rs]) < (0 || GPR [rt]) then
           TrapException
           endif
```

Exceptions:

Trap exception

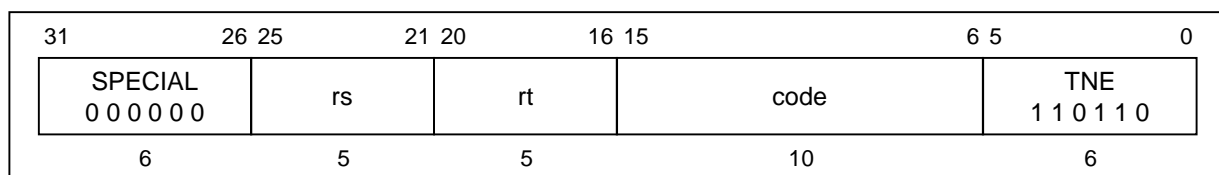
TNE**Trap If Not Equal****TNE****Format:**

TNE rs, rt

Description:

The contents of general register *rt* are compared to general register *rs*. If the contents of general register *rs* are not equal to the contents of general register *rt*, a trap exception occurs.

The code field is available for use as software parameters, but is retrieved by the exception handler only by loading the contents of the memory word containing the instruction.

Operation:

```

32, 64 T:  if GPR [rs] ≠ GPR [rt] then
            TrapException
            endif

```

Exceptions:

Trap exception

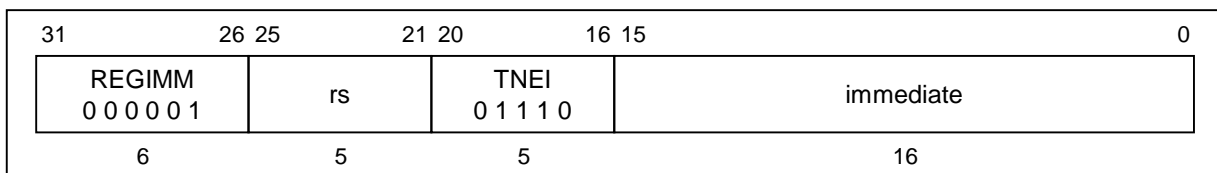
TNEI**Trap If Not Equal Immediate****TNEI****Format:**

TNEI rs, immediate

Description:

The 16-bit *immediate* is sign-extended and compared to the contents of general register *rs*. If the contents of general register *rs* are not equal to the sign-extended *immediate*, a trap exception occurs.

Operation:

```

32  T:  if GPR [rs] ≠ (immediate15)16 || immediate15..0 then
           TrapException
        endif

64  T:  if GPR [rs] ≠ (immediate15)48 || immediate15..0 then
           TrapException
        endif

```

Exceptions:

Trap exception

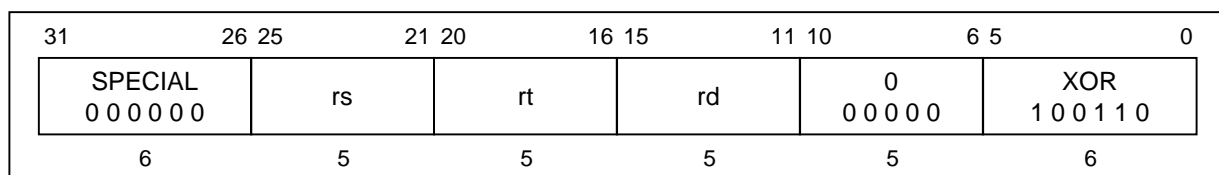
XOR**Exclusive Or****XOR****Format:**

XOR rd, rs, rt

Description:

The contents of general register *rs* are combined with the contents of general register *rt* in a bit-wise logical exclusive OR operation.

The result is placed into general register *rd*.

Operation:

32, 64 T: GPR [rd] <- GPR [rs] xor GPR [rt]

Exceptions:

None

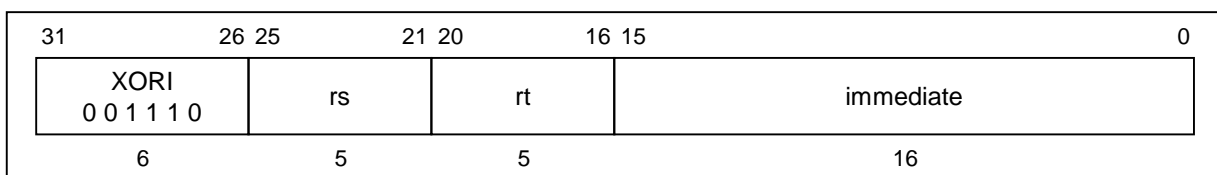
XORI**Exclusive OR Immediate****XORI****Format:**

XORI *rt*, *rs*, *immediate*

Description:

The 16-bit *immediate* is zero-extended and combined with the contents of general register *rs* in a bit-wise logical exclusive OR operation.

The result is placed into general register *rt*.

Operation:

32 T: GPR [*rt*] <- GPR [*rs*] xor (0¹⁶ || *immediate*)

64 T: GPR [*rt*] <- GPR [*rs*] xor (0⁴⁸ || *immediate*)

Exceptions:

None

27.6 CPU INSTRUCTION OPCODE BIT ENCODING

The remainder of this chapter presents the opcode bit encoding for the CPU instruction set (ISA and extensions), as implemented by the VR4102. Figure 27-2 lists the VR4102 Opcode Bit Encoding.

Figure 27-1. VR4102 Opcode Bit Encoding (1/2)

		Opcode							
		28...26							
31...29		0	1	2	3	4	5	6	7
0		SPECIAL	REGIMM	J	JAL	BEQ	BNE	BLEZ	BGTZ
1		ADDI	ADDIU	SLTI	SLTIU	ANDI	ORI	XORI	LUI
2		COPO	π	π	*	BEQL	BNEL	BLEZL	BGTZL
3		DADDI ϵ	DADDIU ϵ	LDL ϵ	LDR ϵ	*	*	*	*
4		LB	LH	LWL	LW	LBU	LHU	LWR	LWU ϵ
5		SB	SH	SWL	SW	SDL ϵ	SDR ϵ	SWR	CACHE δ
6		*	π	π	*	*	π	π	LD ϵ
7		*	π	π	*	*	π	π	SD ϵ

		SPECIAL function							
		2...0							
5...3		0	1	2	3	4	5	6	7
0		SLL	*	SRL	SRA	SLLV	*	SRLV	SRAV
1		JR	JALR	*	*	SYSCALL	BREAK	*	SYNC
2		MFHI	MTHI	MFLO	MTLO	DSLLV ϵ	*	DSRLV ϵ	DSRAV ϵ
3		MULT	MULTU	DIV	DIVU	DMULT ϵ	DMULTU ϵ	DDIV ϵ	DDIVU ϵ
4		ADD	ADDU	SUB	SUBU	AND	OR	XOR	NOR
5		MADD16	DMADD16	SLT	SLTU	DADD ϵ	DADDU ϵ	DSUB ϵ	DSUBU ϵ
6		TGE	TGEU	TLT	TLTU	TEQ	*	TNE	*
7		DSLL ϵ	*	DSRL ϵ	DSRA ϵ	DSLL32 ϵ	*	DSRL32 ϵ	DSRA32 ϵ

		REGIMM rt							
		18...16							
20...19		0	1	2	3	4	5	6	7
0		BLTZ	BGEZ	BLTZL	BGEZL	*	*	*	*
1		TGEI	TGEIU	TLTI	TLTIU	TEQI	*	TNEI	*
2		BLTZAL	BGEZAL	BLTZALL	BGEZALL	*	*	*	*
3		*	*	*	*	*	*	*	*

Figure 27-1. VR4102 Opcode Bit Encoding (2/2)

23...21		COP0 rs						
25, 24	0	1	2	3	4	5	6	7
0	MF	DMF ϵ	γ	γ	MT	DMT ϵ	γ	γ
1	BC	γ	γ	γ	γ	γ	γ	γ
2	CO							
3								

18...16		COP0 rt						
20...19	0	1	2	3	4	5	6	7
0	BCF	BCT	BCFL	BCTL	γ	γ	γ	γ
1	γ	γ	γ	γ	γ	γ	γ	γ
2	γ	γ	γ	γ	γ	γ	γ	γ
3	γ	γ	γ	γ	γ	γ	γ	γ

2...0		COP0 Function						
5...3	0	1	2	3	4	5	6	7
0	ϕ	TLBR	TLBWI	ϕ	ϕ	ϕ	TLBWR	ϕ
1	TLBP	ϕ	ϕ	ϕ	ϕ	ϕ	ϕ	ϕ
2	ξ	ϕ	ϕ	ϕ	ϕ	ϕ	ϕ	ϕ
3	ERET χ	ϕ	ϕ	ϕ	ϕ	ϕ	ϕ	ϕ
4	ϕ	STANDB	SUSPEND	HIBERNATE	ϕ	ϕ	ϕ	ϕ
5	ϕ	ϕ	ϕ	ϕ	ϕ	ϕ	ϕ	ϕ
6	ϕ	ϕ	ϕ	ϕ	ϕ	ϕ	ϕ	ϕ
7	ϕ	ϕ	ϕ	ϕ	ϕ	ϕ	ϕ	ϕ

Key:

- * Operation codes marked with an asterisk cause reserved instruction exceptions in all current implementations and are reserved for future versions of the architecture.
- γ Operation codes marked with a gamma cause a reserved instruction exception. They are reserved for future versions of the architecture.
- δ Operation codes marked with a delta are valid only for VR4102 processors with CP0 enabled, and cause a reserved instruction exception on other processors.
- ϕ Operation codes marked with a phi are invalid but do not cause reserved instruction exceptions in VR4102 implementations.
- ξ Operation codes marked with a xi cause a reserved instruction exception on VR4102 processor.
- χ Operation codes marked with a chi are valid on R4x00 and VR4102 only.
- ϵ Operation codes marked with epsilon are valid when the processor operating as a 64-bit processor. These instructions will cause a reserved instruction exception if 64-bit operation is not enabled.
- π Operation codes marked with a pi are invalid and cause coprocessor unusable exception.

[MEMO]

CHAPTER 28 VR4102 COPROCESSOR 0 HAZARDS

The VR4100 CPU core avoids contention of its internal resources by causing a pipeline interlock in such cases as when the contents of the destination register of an instruction are used as a source in the succeeding instruction. Therefore, instructions such as NOP must not be inserted between instructions.

However, interlocks do not occur on the operations related to the CP0 registers and the TLB. Therefore, contention of internal resources should be considered when composing a program which manipulates the CP0 registers or the TLB. The CP0 hazards define the number of NOP instructions which is required to avoid contention of internal resources, or the number of instructions unrelated to contention. This chapter describes the CP0 hazards of the VR4100 CPU core.

The CP0 hazards of the VR4100 CPU core are equally or less stringent than those of the VR4000; Table 28-1 lists the Coprocessor 0 hazards of the VR4100 CPU core. Code which complies with these hazards will run without modification on the VR4000.

The contents of the CP0 registers or the bits in the "Source" column of this table can be used as a source after they are fixed.

The contents of the CP0 registers or the bits in the "Destination" column of this table can be available as a destination after they are stored.

Based on this table, the number of NOP instructions required between instructions related to the TLB is computed by the following formula, and so is the number of instructions unrelated to contention:

$$(\text{Destination Hazard number of A}) - [(\text{Source Hazard number of B}) + 1]$$

As an example, to compute the number of instructions required between an MTC0 and a subsequent MFC0 instruction, this is:

$$(5) - (3 + 1) = 1 \text{ instruction}$$

The CP0 hazards do not generate interlocks of pipeline. Therefore, the required number of instruction must be controlled by program.

Table 28-1. VR4102 Coprocessor 0 Hazards

Instruction or Event	Source		Destination	
	CP0 Data Used, Stage Used	No. of cycles	CP0 Data Written, Stage Available	No. of cycles
MTC0			CPR [rd]	5
MFC0	CPR [rd]	3		
TLBR	Index, TLB	2	PageMask, EntryHi, EntryLo0, EntryLo1	5
TLBWI TLBWR	Index or Random, PageMask, EntryHi, EntryLo0, EntryLo1	2	TLB	5
TLBP	PageMask, EntryHi	2	Index	6
ERET	EPC or ErrorEPC, TLB	2	Status [EXL, ERL]	4
	Status	2		
CACHE Index Load Tag			TagLo, TagHi, PErr	5
CACHE Index Store Tag	TagLo, TagHi, PErr	3		
CACHE Hit ops.	cache line	3	cache line	5
Load/Store	EntryHi [ASID], Status [KSU, EXL, ERL, RE], Config [K0C], TLB	3		
	Config [AD, EP]	3		
	WatchHi, WatchLo	3		
Load/Store exception			EPC, Status, Cause, BadVAddr, Context, XContext	5
Instruction fetch exception			EPC, Status	4
			Cause, BadVAddr, Context, XContext	5
Instruction fetch	EntryHi [ASID], Status [KSU, EXL, ERL, RE], Config [K0C]	2		
	TLB	2		
Coproc. usable test	Status [CU, KSU, EXL, ERL]	2		
Interrupt signals sampled	Cause [IP], Status [IM, IE, EXL, ERL]	2		
TLB shutdown			Status [TS]	2 (Inst.), 4 (Data)

Cautions 1. If the setting of the K0 bit in the Config register is changed to uncached mode by MTC0, the accessed memory area is switched to the uncached one at the instruction fetch of the third instruction after MTC0.

2. A stall of several instructions occurs if a jump or branch instruction is executed immediately after the setting of the ITS bit in the Status register.

Remarks 1. The instruction following MTC0 must not be MFC0.

2. The five instructions following MTC0 to Status register that changes KSU and sets EXL and ERL may be executed in the new mode, and not kernel mode. This can be avoided by setting EXL first, leaving KSU set to kernel, and later changing KSU.

3. There must be two non-load, non-CACHE instructions between a store and a CACHE instruction directed to the same primary cache line as the store.

The status during execution of the following instruction for which CP0 hazards must be considered is described below.

(1) MTC0

Destination: The completion of writing to a destination register (CP0) of MTC0.

(2) MFC0

Source: The confirmation of a source register (CP0) of MFC0.

(3) TLBR

Source: The confirmation of the status of TLB and the Index register before the execution of TLBR.

Destination: The completion of writing to a destination register (CP0) of TLBR.

(4) TLBWI, TLBWR

Source: The confirmation of a source register of these instructions and registers used to specify a TLB entry.

Destination: The completion of writing to TLB by these instructions.

(5) TLBP

Source: The confirmation of the PageMask register and the EntryHi register before the execution of TLBP.

Destination: The completion of writing the result of execution of TLBP to the Index register.

(6) ERET

Source: The confirmation of registers containing information necessary for executing ERET.

Destination: The completion of the processor state transition by the execution of ERET.

(7) CACHE Index Load Tag

Destination: The completion of writing the results of execution of this instruction to the related registers.

(8) CACHE Index Store Tag

Source: The confirmation of registers containing information necessary for executing this instruction.

(9) Coprocessor Usable Test

Source: The confirmation of modes set by the bits of the CP0 registers in the “Source” column.

- Examples**
1. When accessing the CP0 registers in User mode after the content of the CU0 bit of the Status register is modified, or when executing an instruction such as TLB instructions, CACHE instructions, or branch instructions which use the resource of the CP0.
 2. When accessing the CP0 registers in the operating mode set in the Status register after the KSU, EXL, and ERL bits of the Status register are modified.

www.DataSheet4U.com

(10) Instruction Fetch

Source: The confirmation of the operating mode and TLB necessary for instruction fetch.

- Examples**
1. When changing the operating mode from User to Kernel and fetching instructions after the KSU, EXL, and ERL bits of the Status register are modified.
 2. When fetching instructions using the modified TLB entry after TLB modification.

(11) Instruction Fetch Exception

Destination: The completion of writing to registers containing information related to the exception when an exception occurs on instruction fetch.

(12) Interrupts

Source: The confirmation of registers judging the condition of occurrence of interrupt when an interrupt factor is detected.

(13) Loads/Stores

Source: The confirmation of the operating mode related to the address generation of Load/Store instructions, TLB entries, the cache mode set in the K0 bit of the Config register, and the registers setting the condition of occurrence of a Watch exception.

Example When Loads/Stores are executed in the kernel field after changing the mode from User to Kernel.

(14) Load/Store Exception

Destination: The completion of writing to registers containing information related to the exception when an exception occurs on load or store operation.

(15) TLB Shutdown

Destination: The completion of writing to the TS bit of the Status register when a TLB shutdown occurs.

Table 28-2 indicates examples of calculation.

Table 28-2. Calculation Example of CP0 Hazard and the Number of Instructions Inserted

Destination	Source	Contending internal resource	Number of instructions inserted	Formula
TLBWR/TLBWI	TLBP	TLB Entry	2	$5 - (2 + 1)$
TLBWR/TLBWI	Load or Store using newly modified TLB	TLB Entry	1	$5 - (3 + 1)$
TLBWR/TLBWI	Instruction fetch using newly modified TLB	TLB Entry	2	$5 - (2 + 1)$
MTC0, Status [CU]	Coprocessor instruction which requires the setting of CU	Status [CU]	2	$5 - (2 + 1)$
TLBR	MFC0 EntryHi	EntryHi	1	$5 - (3 + 1)$
MTC0 EntryLo0	TLBWR/TLBWI	EntryLo0	2	$5 - (2 + 1)$
TLBP	MFC0 Index	Index	2	$6 - (3 + 1)$
MTC0 EntryHi	TLBP	EntryHi	2	$5 - (2 + 1)$
MTC0 EPC	ERET	EPC	2	$5 - (2 + 1)$
MTC0 Status	ERET	Status	2	$5 - (2 + 1)$
MTC0 Status [IE] ^{Note}	Instruction which causes an interrupt	Status [IE]	2	$5 - (2 + 1)$

Note The number of hazards is undefined if the instruction execution sequence is changed by exceptions. In such a case, the minimum number of hazards until the IE bit value is confirmed may be the same as the maximum number of hazards until an interrupt request occurs which is pending and enabled.

[MEMO]

CHAPTER 29 PLL PASSIVE COMPONENTS

The Phase Locked Loop circuit requires several passive components for proper operation, which are connected to V_{DDP} and $GNDP$ as illustrated in Figure 29-1.

Figure 29-1. Example of Connection of PLL Passive Components

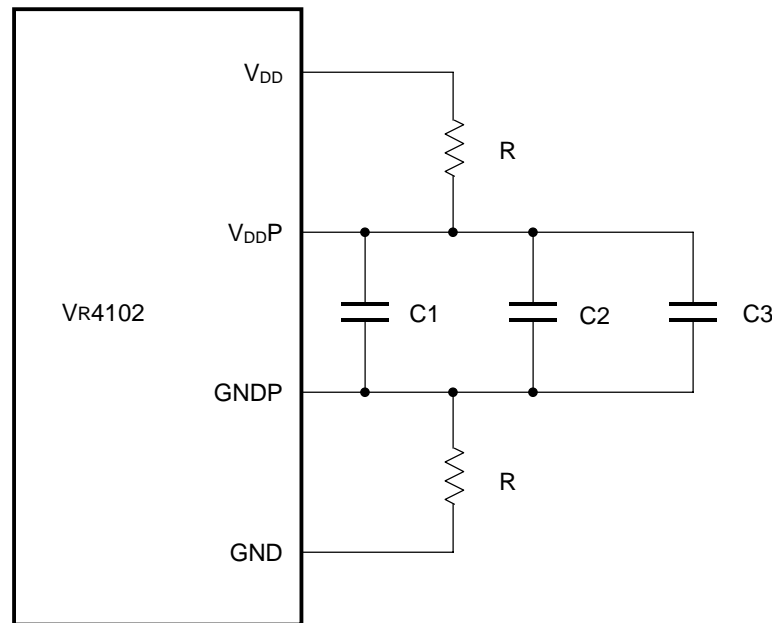

- Remarks1.** C1, C2, C3 capacitors and R resistors are mounted on the printed circuit board.
2. Since the value for the components depends upon the application system, the optimum values for each system should be decided after repeated experimentation.

It is essential to isolate the analog power and ground for the PLL circuit ($V_{DDP}/GNDP$) from the regular power and ground (V_{DD}/GND). Initial evaluations have yielded good results with the following values:

$$R = 5 \Omega$$

$$C1 = 1 \text{ nF}$$

$$C2 = 2 \text{ nF}$$

$$C3 = 10 \mu\text{F}$$

Since the optimum values for the filter components depend upon the application and the system noise environment, these values should be considered as starting points for further experimentation within your specific application. In addition, the chokes (inductors: L) can be considered for use as an alternative to the resistors (R) for use in filtering the power supply.

[MEMO]

www.DataSheet4U.com

APPENDIX A DIFFERENCES BETWEEN VR4102 AND VR4101

A.1 SUMMARY OF DIFFERENCES

Item		VR4102	VR4101
Cache size		Instruction: 4 Kbytes, data: 1 Kbyte	Instruction: 2 Kbytes, data: 1 Kbyte
ISA interface	Bus sizing	16-/8-bit dynamic bus sizing	Select 16-/8-bit bus with address spaces
	Bus hold	Available	Not available
	I/O space	64 Mbytes	4 Mbytes
	Memory space	64 Mbytes	4 Mbytes
LCD memory space		Switches between LCD mode and high-speed memory mode	Supports only LCD mode
Memory controller	Max. DRAM capacity (EDO type)	32 Mbytes	8 Mbytes
	Max. ROM capacity	32 Mbytes	16 Mbytes
	DRAM type	16 Mbits, 64 Mbits	16 Mbits
	ROM type	32 Mbits, 64 Mbits	16 Mbits, 32 Mbits
Power-on factor		4 factors	3 factors
DMA controller		Connected to AIU and FIR Uses a DMA space for each page	Connected to AIU, PIU, KIU, and SIU Uses a DMA space linearly
Timer, counter		4 channels: 24 bits x 2 (32.768 kHz) 48 bits x 1 (32.768 kHz) 25 bits x 1 (for performance test, TClock)	3 channels: 24 bits x 1 (32.768 kHz) 48 bits x 1 (32.768 kHz) 31 bits x 1 (for performance test, TClock)
Keyboard interface		Supports 64/80/96 keys	Supports up to 64 keys
Audio interface		Supports PCM input/output On-chip D/A converter	Supports PWM/Buzz output
Touch panel interface		On-chip 10-bit A/D converter On-chip touch panel controller	External 10/12-bit A/D converter External touch panel controller
Serial interface		NS16650 compatible x 1 (Max. data rate: 1.152 Mbps) NEC original x 1 (Max. data rate: 115.2 kbps Max.)	NEC original x 2 (Max. data rate: 115.2 kbps)
Ports for LED lighting		Available	Not available
MODEM interface		On-chip interface supporting software MODEM (equivalent to PCT288I)	Not available
IrDA interface		FIR (Max. data rate: 4 Mbps)	SIR (Max. data rate: 115.2 kbps)
General-purpose I/O ports		49 Max. (including alternate-function pins)	12 Max.
Clock input		32.768 kHz (input to CG), 18.432 MHz (input to CG), 48 MHz (directly connected to on-chip IrDA interface)	32.768 kHz (input to CG)
Package		216 pin LQFP, 224-pin FBGA	160 pin LQFP

A.2 DETAILS OF DIFFERENCES

A.2.1 CPU Core

(1) Cache Size

The instruction cache of the VR4102 is 4K bytes in size, on the other hand, that of the VR4101 is 2K bytes. The size of the data cache of the VR4102 is 1K bytes which is the same as that of the VR4101.

To specify cache data address used for CACHE instruction, the VR4102 uses bit 31..12 of the TagLo register, in contrast to the VR4101 which uses bit 31..11. For data cache, both the VR4102 and the VR4101 use bit 13..10 of the TagLo register.

(2) Settings of the Config Register

Bit 12 of the Config register (CS) indicates cache size mode, bit 11..9 (IC) indicates instruction cache size, and bit 8..5 (DC) indicates data cache size. In the VR4102, CS is set to 1 (cache of small capacity), IC to 010 (4K bytes), and DC to 000 (1K bytes). In the VR4101, bit 12..5 of the Config register are not defined and fix to 0 as a reserved field.

Bit 27..24 of the Config register (EP) indicates transfer data pattern in the cache writeback. This field must be set to 0000 (DD) in the VR4102, on the other hand, it must be set to 0011 (DxDx) in the VR4101.

A.2.2 Address Mapping

(1) Memory Area

In the VR4102, 16M and 64M bits are selectable for DRAM space size, though only a 16M-bit DRAM can be connected to the VR4101.

Similarly, 32M and 64M bits are selectable for ROM space size in the VR4102, though only a 32M-bit ROM can be connected to the VR4101.

(2) LCD Space

The LCD space is mapped to 16M-byte area of 0x0A00 0000 through 0x0AFF FFFF in both the VR4102 and the VR4101. However, the VR4102 can also use this area as the high speed memory space, and the switching is set in one of the BCU registers.

(3) ISA Spaces

The ISA memory and I/O spaces have a size of 64M bytes respectively in the VR4102. Those in the VR4101 have 4M bytes in total (2M bytes for 8-bit bus, 2M bytes for 16-bit bus).

In addition, the VR4102 supports 16/8-bit dynamic sizing for the ISA bus.

(4) Internal I/O Space

The internal I/O space is expanded to 32M bytes in the VR4102 compared to that of the VR4101 which has a size of 16M bytes.

A.2.3 BCU

(1) Setting of BCU Transaction

In the Vr4101, the intervals of bus transactions and the number of repetitions in the enabled BCU transaction intervals can be selectable. This function is deleted in the Vr4102.

(2) Memory Access Control

16 and 32 bits are selectable as the data bus width with DBUS32 pin at reset in the Vr4102 except for ISA memory area, on the other hand, the bus width is fixed to 16 bits in the Vr4101.

Though both the Vr4102 and the Vr4101 can select three memory types which are DRAM, masked ROM, and Flash memory, their memory sizes and mapping method are different as summarized below.

www.DataSheet4U.com

Memory type	Vr4102	Vr4101
DRAM	16M-bit/64M-bit EDO x 16 bits (access time: 60 ns)	16M-bit EDO x 16 bits (access time: 60 ns)
Masked ROM	32M-bit/64M-bit ordinary or page type x 16 bits 16-bit bus mode: selected as banks0/1 or 2/3 32-bit bus mode: selected as bank0 or 1	32M-bit ordinary or page type x 16 bits The whole ROM space is selected
Flash memory	16-bit bus mode: selected as banks0/1 or 2/3 32-bit bus mode: selected as bank0 or 1	To use the whole ROM space can be selected

(3) LCD Space

The LCD space is used only for LCD access in the Vr4101, while it can be used for either LCD access or high-speed memory access in the Vr4102. Which of LCD or high-speed memory the LCD space is used for is selected in BCUCNT1REG register. When high-speed memory is selected, LCDCS# pin becomes active.

The access time for LCD is selectable among 2, 4, 6, and 8 TClock cycles in both the Vr4102 and the Vr4101. For high-speed memory in the Vr4102, the access time is selectable among 1, 2, 3, 4, 5, 6, 7, and 8 TClock cycles. These selections of access time are set in BCUSPEEDREG register.

When transferring LCD data, inverting the data values or not is selectable in the Vr4102 and is set in BCUCNT2REG register. On the other hand, the Vr4101 always inverts the values at LCD data transfer.

(4) ISA Space

In the Vr4102, the bus size is dynamically controlled at every bus cycle with IOCS# and MEMCS# pins. In the Vr4101, the bus size is fixed to 8 or 16 bits and is distinguished by the accessed address space.

(5) Others

The Vr4102 has bus hold function and can make ISA, LCD, and memory interfaces into bus hold state. The Vr4101 has no bus hold function, and therefore the CPU is always master state.

Bit 11..8 and bit 3..0 of PREVIDREG register indicate the revision number of the on-chip peripheral units in both the Vr4102 and the Vr4101. In addition, bit 15..12 indicates the processor revision number in the Vr4102, though it is fixed to 0 in the Vr4101. The remaining bits, bit 7..4, are fixed to 0 in both processors.

A.2.4 DMA

(1) Sources of DMA

The VR4102 uses DMA transfer for AIU reception, AIU transmission, and FIR transmission/reception (in priority order). On the other hand, the VR4101 uses DMA transfer for AIU, PIU, SIU reception, SIU transmission, and KIU (in priority order).

(2) DMA Operation

The VR4102 reloads the DMA base address every time the DMA transfer reaches page boundary. The VR4101 uses DMA address space linearly which starts at DMA base address. For more details about DMA address manipulation, see Chapter 11.

www.DataSheet4U.com

A.2.5 ICU

(1) Sources of Interrupts

Compared with the VR4101, five interrupt sources, HSP, LED, FIR, RTC Long timer 2, and TClock counter, are newly added in the VR4102 ICU. Three more software interrupts which are caused by setting the SOFTINTREG register are also added. The number of interrupt factors are changed in eight interrupt sources which are SIU, DSIU, GIU, KIU, AIU, PIU, KIU in Suspend mode, and PIU in Suspend mode.

(2) Notification to the CPU Core

In the VR4102, NMI and Int[3..0] signals are used to notify interrupt requests to the CPU core, in contrast to the VR4101 which uses NMI and Int[1..0] signals.

A.2.6 PMU

(1) Power-On Function

Compared with the VR4101, GPIO[3..0] and GPIO[12..9] inputs are added in the VR4102 as a CPU activation factor. Especially, GPIO[3] can be used without any settings immediately after RTCRST.

(2) BATTLOCK and CARDLOCK Notifications

No dedicated pins for BATTLOCK and CARDLOCK functions are assigned in the VR4102. They must be assigned to either of GPIO[12..9] pins and they are manipulated as two of GIU interrupts.

A.2.7 RTC

(1) RTC Long Timers

The VR4102 has two RTC Long timers, on the other hand the VR4101 has only one.

(2) TClock Counter

TClock counter of the VR4102 is 25-bit long which is 6 bits shorter than that of the VR4101.

TClock counter of the VR4102 is added as one of the interrupt factors, and an interrupt request occurs when its value becomes 1. In the VR4101, no interrupt request is caused by TClock counter.

A.2.8 GIU

(1) GPIO Pins

The VR4102 has 49 general-purpose I/O pins and 33 of them have alternate functions, while the VR4101 has 12 general I/O pins and none of them have alternate functions.

GPIO[15] pin of the VR4102 is assigned as DCD# input which has dedicated pin in the VR4101. In both the VR4102 and the VR4101, GIU controls DCD# input as well as GPIO pins.

GPIO pins are also used as interrupt request inputs except for GPIO[49..32] of the VR4102, and in which power modes an interrupt request is enabled is different from each GPIO pin.

The functions of GPIO pins are as summarized below.

Pins	I/O	Interrupt input	Enabled power mode		Alternative functions in VR4102	Notes
			VR4102	VR4101		
GPIO[49]	O	N/A	Standby	-	-	
GPIO[48]	I/O	N/A	Standby	-	DBUS32	
GPIO[47..44]	I/O	N/A	Standby	-	DSIU pins	
GPIO[43..32]	O	N/A	Standby	-	KSCAN[11..0]	
GPIO[31..16]	I/O	A	Standby	-	DATA[31..16]	
GPIO[15]	I	A	Hibernate	-	DCD#	1
GPIO[14]	I/O	A	Suspend	-	-	
GPIO[13]	I/O	A	Suspend	Hibernate	-	2
GPIO[12]	I/O	A	Suspend	-	-	
GPIO[11]	I/O	A	Suspend	Standby	-	
GPIO[10..9]	I/O	A	Suspend	Suspend	-	
GPIO[8..4]	I/O	A	Standby	Standby	-	
GPIO[3..0]	I/O	A	Hibernate	Standby	-	

Notes 1. This pin is assigned as DCD# input in the VR4102.

2. This pin does not exist in the VR4101. DCD input is internally connected to the corresponding register bits for GPIO[13] in GIU and the VR4101 manipulates those bits as input only.

(2) Interrupt Input Control

In both the VR4102 and the VR4101, either edge, high level, or low level of the input signal is selectable as an interrupt input trigger.

In the VR4102, whether interrupt requests are held in GIU or not is selectable, while they are not held in the VR4101.

A.2.9 PIU

PIU of the VR4102 is greatly changed from that of the VR4101 as summarized below.

Item	VR4102	VR4101
A/D converter	On-chip (10 bits)	External (10/12 bits)
Data transfer	Transfer to buffer in PIU	DMA transfer
Data buffers	Four buffers (two pages each) for coordinate data only Four buffers for A/D scan	One buffer
Scan types	Coordinate data scan Command scan A/D scan	Coordinate data scan Command scan Main battery scan Sub battery scan
A/D port scan activation states	Standby, WaitPen Touch, Interval	Standby
Panel applied voltage stabilization standby time counter	6 bits	4 bits
Panel applied voltage during low-voltage mode	All four touch panel pins are at low level	All four touch panel pins are at Hi-Z
Panel state during disable state	Touch detection state (Interrupts do not occur when CPU is in Hibernate mode.)	All four touch panel pins are at Hi-Z
Handling of valid data when data loss occurs	Valid data is always retained	Valid data is overwritten
Data interrupt	Three types of special-purpose interrupts (two coordinate data interrupts, A/D scan interrupt, and command scan interrupt)	Two types of page boundary interrupts
PIUDataRdyIntr	No	Yes

A.2.10 AIU

(1) Audio Output Mode

The PCM output is employed in the VR4102 as an audio output mode. In the VR4101, Buzzer or PWM output is selectable.

(2) Audio Input Mode

The VR4102 has an analog audio input which is connected to the on-chip A/D converter. The VR4101 does not support any audio inputs.

(3) Audio Data Transfer

The VR4102 uses DMA transfer to prepare PCM data in the output operation and to store sampled data in the input operation. In the VR4101, output frequency and period for the Buzz mode are set in the AIU registers, or output high level and low level width for the PWM mode are prepared with DMA transfer.

(4) Volume Control

Volume of the audio outputs is controlled by an external circuit or by shifting data input to D/A converter in the VR4102. In the VR4101, four steps of audio output volume can be set in the AIUMUTEREG register and are controlled by an external circuit based on the settings in the register.

A.2.11 KIU

(1) Number of Keys Supported

In the VR4102, the number of scan lines used is selectable among 8, 10, and 12 by setting the SCANLINE register, which determines the number of keys enabled to either of 64, 80, or 96. The VR4102 can detect when any of enabled keys are pressed using selected scan lines and 8 detection lines. The VR4101 can detect when any of 64 keys are pressed using 8 scan lines and 8 detection lines.

When the VR4102 uses only 8 or 10 scan lines, the unused scan lines can be used as general-purpose output ports. When the KIU is disabled in the VR4102, all the scan lines (KSCAN[11..0] pins) can be used as general-purpose outputs (GPIO[43..32]).

(2) LCD Brightness Control

The VR4101 has LCD brightness control pins which are alternately used as KCSAN[1..0] pins and indicate the contents of EVVOLREG register to specify brightness. The VR4102 has no pins for LCD brightness control.

(3) KIU Data Transfer

The VR4102 transfers KIU data by reading data buffers when an interrupt occurs, while the VR4101 transfers with DMA.

A.2.12 DSIU

(1) Hardware Flow Control

The VR4102 has two pins for hardware flow control, DCTS# and DRTS#, while the VR4101 has no pins for it.

(2) Supported Interrupts

The VR4102 DSIU supports receive error interrupt, receive completion interrupt, transmit completion interrupt, and CTS interrupt. The VR4101 DSIU supports receive error interrupt, receive completion interrupt, and transmit completion interrupt.

(3) Alternative Functions of DSIU Pins

The VR4102 DSIU pins can be used as general-purpose output port, GPIO[47..44], when DSIU is disabled. Those of the VR4101 have no alternative functions.

A.2.13 SIU

The VR4102 SIU is newly designed and is functionally compatible with NS16550 in contrast to that of the VR4101 which is originally designed by NEC. Their differences are as summarized below.

Item	VR4102	VR4102
Architecture	Functionally compatible with NS16550	NEC original
Maximum data rate	1.15 Mbps	115 kbps
IR communication	Available	Available
Data transfer	Read out of FIFO buffers by software	DMA
Character length	5, 6, 7, or 8 bits	7 or 8 bits
Stop bit length	1, 1.5 (for 5 bits), or 2 (for 6, 7, or 8 bits)	1 or 2
Parity check	Checked/generated is selectable	Checked/not generated (substituted by software)
Framing error	Automatically detected	Automatically detected
Break transmission	Available	Available
Break detection	Automatically detected	Automatically detected
Receive overrun error	Automatically detected	Occurs receive data lost interrupt
Flow control pins	RTS#, CTS#, DTR#, DSR#, DCD#	RTS#, CTS#, DTR#, DSR#, DCD
Transmit data flow	16450 mode: from SIUTH register to transmit shift register FIFO mode: from FIFO (16 bytes) to transmit shift register	From DMA (2K bytes) to SIUTXDATREG
Receive data flow	16450 mode: from receive shift register to SIURB register FIFO mode: from receive shift register to FIFO (16 bytes)	From SIURXDATREG to DMA (2K bytes)

A.2.14 Newly Added Units

The VR4102 has three newly designed peripheral units as described below which the VR4101 does not have.

(1) LED

This unit is used to control lighting of an LED. This unit features as below:

- High level width (up to 2 seconds), low level width (up to 8 seconds), and the number of blink can be set
- Supports stop interrupt request
- Enabled during Standby, Suspend, and Hibernate modes

(2) HSP

This unit is used to realize a software MODEM with externally connected CODEC and DAA blocks. The HSP unit of the VR4102 is compatible with PCT288I produced by PCTel.

The assigned functions of software and each block are as below.

Software: protocol calculation, CODEC control, error correction, and OS interface

HSP unit: serial/parallel conversion of 16-bit data, control of status pins, and FIFO buffer management

CODEC: D/A, A/D conversion and operation clock supply based on MCLK of HSP unit

DAA: interface for CODEC data and telephone circuits

(3) FIR

This unit is used for IrDA communication in high-speed data transfer. Supported transfer rates includes 0.576M, 1.152M, and 4M bps.

[MEMO]

www.DataSheet4U.com

APPENDIX B INDEX

A

A/D converter ... 381, 383, 422
A/D port scan ... 404
Access data size ... 247
Address error exception ... 180
Address translation ... 119, 120
Addressing ... 47
AIU ... 31, 409
AIU registers ... 39, 409
AIUIAHREG ... 275
AIUIALREG ... 275
AIUIBAHREG ... 273
AIUIBALREG ... 273
AIUINTREG ... 298
AIUOAHREG ... 278
AIUOALREG ... 278
AIUOBALREG ... 276
AIUOBALREG ... 276
ASIM00REG ... 438
ASIM01REG ... 439
ASIS0REG ... 444
Audio Interface Unit (AIU) ... 31, 409

B

BadVAddr register ... 161
Baud rates and divisors ... 466
BCU ... 31, 235
BCU registers ... 33, 235
BCUCNTREG 1 ... 236
BCUCNTREG 2 ... 238
BCUERRSTREG ... 241
BCURFCNTREG ... 242
BCURFCOUNTREG ... 244
BCUSPEEDREG ... 239
BEV ... 211
Bootstrap exception vector (BEV) ... 211
BPRM0REG ... 446
Branch address ... 93
Branch delay ... 102
Branch instruction ... 92, 528
Breakpoint exception ... 186
Bus Control Unit (BCU) ... 31, 235
Bus error exception ... 185
Bus hold ... 268
Bus interface ... 43
Bus mode ... 247
Bypassing ... 115

C

Cache ... 51
Cache data integrity ... 220
Cache error check ... 212
Cache error exception ... 184
Cache error register ... 171
CACHE instruction ... 219, 220
Cache line ... 214, 218
Cache memory ... 213
Cache operations ... 217
Cache organization ... 214
Cache state transition ... 219
Cache states ... 218
Cause register ... 165
CLKSPEEDREG ... 245
Clock generator ... 43
Clock interface ... 53
Clock Mask Unit (CMU) ... 31, 289
Clock oscillator ... 54
CMU ... 31, 289
CMU register ... 34, 289
CMUCLKMSK ... 290
Code compatibility ... 115
Cold reset ... 207
Cold reset exception ... 177
Compare register ... 162
Computational instructions ... 86
Config register ... 150
Connection of address pins ... 246
Context register ... 160
Coordinate detection ... 382
Coprocessor 0 (CP0) ... 44, 49, 141
Coprocessor Unusable exception ... 187
Count register ... 161
CP0 ... 44, 49, 141
CP0 hazards ... 677
CP0 registers ... 49, 50, 141, 146
CPU ... 43
CPU bus interface ... 43
CPU core ... 43
CPU Instruction ... 46, 81, 525
CPU Instruction Set ... 46, 81, 525
CPU registers ... 45
CRCSR ... 508
Crystal oscillation ... 54

D

D/A converter ... 421
 Data cache ... 44, 215
 Data cache addressing ... 216
 Data formats ... 47, 448
 Data loss ... 405
 DCU ... 31, 281
 DCU registers ... 34, 281
 Deadman's SW shutdown ... 320
 Deadman's Switch ... 202
 Deadman's Switch Unit (DSU) ... 31, 355
 Debug Serial Interface Unit (DSIU) ... 32, 435
 Defining access types ... 82
 Direct Memory Access (DMA) ... 271, 421, 422, 513, 522
 Direct Memory Access Address Unit (DMAAU) ... 31, 271
 Direct Memory Access Control Unit (DCU) ... 31, 281
 DMA priority levels ... 281
 DMAAU ... 31, 271
 DMAAU registers ... 33, 272
 DMACR ... 512
 DMAER ... 513
 DMAIDLEREG ... 283
 DMAMSKREG ... 285
 DMAREQREG ... 286
 DMARSTREG ... 282
 DMASENREG ... 284
 DPCNTR ... 501
 DPINTR ... 500
 DRAM ... 140
 DRAM access ... 264
 DRAM space ... 140
 DSIU ... 32, 435
 DSIU registers ... 40, 435
 DSIUINTRREG ... 301
 DSIURESETREG ... 447
 DSU ... 31, 355
 DSU registers ... 37, 355
 DSUCLRREG ... 358
 DSUCNTRREG ... 356
 DSUSETREG ... 357
 DSUTIMREG ... 359
 DVALIDREG ... 418

E

ECMPHREG ... 340
 ECMPREG ... 339
 ECMPMREG ... 339
 Elapsed Timer ... 335
 Endianness ... 47, 48

EntryHi register ... 147
 EntryLo register ... 147
 EPC register ... 167
 ErrorEPC register ... 171
 ETIMEHREG ... 338
 ETIMELREG ... 337
 ETIMEMREG ... 337
 Exception ... 109, 173
 Exception conditions ... 112
 Exception processing ... 157, 191
 Exception processing registers ... 159
 Exception Program Counter (EPC) register ... 167
 Exception vector locations ... 173
 External clock ... 54

F

Fast IrDA Interface Unit (FIR) ... 32, 497
 FIFO interrupt modes ... 470
 FIFO polling mode ... 471
 FIR ... 32, 497
 FIR registers ... 42, 497
 FIRAHREG ... 280
 FIRALREG ... 280
 FIRBAHREG ... 279
 FIRBALREG ... 279
 FIRCR ... 509
 FIRINTREG ... 313
 Flash memory ... 247
 Flash memory interface ... 249
 FRSTR ... 499
 FSR ... 505
 Fullspeed mode ... 210, 326

G

General Purpose I/O Unit (GIU) ... 31, 361
 GIU ... 31, 361
 GIU registers ... 37, 362
 GIUINTSELH ... 374
 GIUINTSELL ... 373
 GIUINTENH ... 370
 GIUINTENL ... 369
 GIUINTHREG ... 312
 GIUINTHTSELH ... 376
 GIUINTHTSELL ... 375
 GIUINTLREG ... 300
 GIUINTSTATH ... 368
 GIUINTSTATL ... 367
 GIUINTTYPH ... 372
 GIUINTTYPL ... 371
 GIUIOSELH ... 364
 GIUIOSELL ... 363

GIUPIODH ... 366
 GIUPIODL ... 365
 GIUPODATH ... 380
 GIUPODATL ... 378

H

HALTimer shutdown ... 204, 320
 Hardware interrupts ... 232
 Hibernate mode ... 211, 327
 Hierarchy of memory ... 213
 HSP ... 32, 481
 HSP registers ... 41, 483
 HSPCNTL ... 486
 HSPDATA[15..0] ... 485
 HSPERRCNT ... 493
 HSPEXTIN ... 492
 HSPEXTOUT ... 487
 HSPFFSZ ... 489
 HSPID ... 492
 HSPID[7:0] ... 493
 HSPINDEX[15..0] ... 485
 HSPINIT ... 484
 HSPMCLKD ... 488
 HSPPCS[7:0] ... 493
 HSPPCTEL[7:0] ... 493
 HSPRxData ... 490
 HSPSTS ... 491
 HSPTOC ... 488
 HSPTxData ... 485

I

I/O registers ... 33
 ICU ... 31, 291
 ICU registers ... 35, 294
 IE bit ... 212
 IFR ... 517
 Illegal access ... 251
 IMR ... 504
 Index register ... 146
 Initialization interface ... 199
 Instruction cache ... 43, 214
 Instruction cache addressing ... 216
 Instruction formats ... 46, 81
 Instruction pipeline ... 53
 Integer overflow exception ... 189
 Interlock ... 109
 Internal I/O space ... 139
 Interrupt ... 231
 Interrupt control ... 293
 Interrupt Control Unit (ICU) ... 31, 291
 Interrupt enable (IE) ... 212

Interrupt exception ... 190
 Interrupt request signal ... 232
 INTR0REG ... 445
 INTREG ... 420
 IRSR1 ... 507

J

Joint TLB ... 52
 JTLB ... 52
 Jump instruction ... 92, 528

K

Kernel expanded addressing mode ... 211
 Kernel mode ... 127
 Kernel mode address space ... 128
 Keyboard Interface Unit (KIU) ... 32, 423
 KIU ... 32, 423
 KIU registers ... 40, 423
 KIU sequencer ... 427, 428
 KIUDAT0 ... 424
 KIUDAT1 ... 424
 KIUDAT2 ... 424
 KIUDAT3 ... 424
 KIUDAT4 ... 424
 KIUDAT5 ... 424
 KIUGPEN ... 433
 KIUINT ... 431
 KIUINTREG ... 299
 KIURST ... 432
 KIUSCANREP ... 425
 KIUSCANS ... 427
 KIUWKI ... 430
 KIUWKS ... 429

L

LCD ... 140
 LCD control interface ... 250
 LCD interface ... 263
 LCD space ... 140
 LED ... 32, 453
 LED Control Unit (LED) ... 32, 453
 LED registers ... 41, 453
 LEDASTCREG ... 457
 LEDCNTREG ... 456
 LEDHTSREG ... 454
 LEDINTREG ... 458
 LEDLTSREG ... 455
 Load delay ... 102
 Load delay slot ... 82
 Load instruction ... 82, 527
 Load Linked Address (LLAddr) register ... 151

Local loopback ... 473

M

MAUIINTREG ... 305
 MasterOut ... 53
 MCNTREG ... 416
 MCNVRREG ... 417
 MDMADATREG ... 410
 MDSIUINTREG ... 308
 Memory management system (MMU) ... 52, 117
 MFIRINTREG ... 316
 MGIUINTHREG ... 315
 MGIUINTLREG ... 307
 MIDATREG ... 415
 MIRCR ... 511
 MKIUINTREG ... 306
 MODEM Interface Unit (HSP) ... 32, 481
 MODEMREG ... 437
 MPIUINTREG ... 304
 MRXF ... 522
 MSYSINT1REG ... 302
 MSYSINT2REG ... 314

N

NMI exception ... 179
 NMIREG ... 309
 Non-maskable Interrupt (NMI) ... 231

O

Opcode bit encoding ... 674
 Operating modes ... 121
 Operation when unbranched ... 93
 Ordinary Interrupts ... 231
 Ordinary ROM ... 248

P

PageMask register ... 143, 147
 PageROM ... 248
 Parity error prohibit ... 212
 Parity error register ... 170
 PClock ... 53
 Phase lock loop (PLL) ... 43
 Physical address ... 135
 Pin configuration ... 57
 Pin functions ... 57, 62
 Pipeline ... 99
 PIU ... 32, 381
 PIU registers ... 38, 386
 PIUAB0REG ... 400
 PIUAB1REG ... 400
 PIUAB2REG ... 400

PIUAB3REG ... 400
 PIUAMSKREG ... 397
 PIUASCNREG ... 395
 PIUCIVLREG ... 398
 PIUCMDREG ... 393
 PIUCNTREG ... 387
 PIUINTREG (ICU) ... 297
 PIUINTREG (PIU) ... 390
 PIUPB00REG ... 399
 PIUPB01REG ... 399
 PIUPB02REG ... 399
 PIUPB03REG ... 399
 PIUPB04REG ... 399
 PIUPB10REG ... 399
 PIUPB11REG ... 399
 PIUPB12REG ... 399
 PIUPB13REG ... 399
 PIUPB14REG ... 399
 PIUSIVLREG ... 391
 PIUSTBLREG ... 392
 PLL ... 43
 PLL passive components ... 683
 PMU ... 31, 319
 PMU registers ... 35, 327
 PMUCNT2REG ... 333
 PMUCNTREG ... 330
 PMUINT2REG ... 332
 PMUINTREG ... 328
 PORTREG ... 436
 Power Management Unit (PMU) ... 31, 319
 Power mode ... 210, 325
 Power mode state transition ... 325
 Power-on control ... 321
 Power-on sequence ... 205
 Precision of exceptions ... 158
 Priority of exceptions ... 176
 Privilege mode ... 211
 Processor Revision Identifier (PRId) register ... 149

R

Random register ... 146
 RDR ... 503
 Real-time Clock Unit (RTC) ... 31, 335
 Refresh ... 267
 Reserved Instruction exception ... 188
 Reset control ... 319
 Reset function ... 199
 Reverse endian ... 211
 REVIDREG ... 243
 ROM ... 137
 ROM access ... 252

ROM interface ... 248
 ROM space ... 137
 RSTSW ... 201, 319
 RTC ... 31, 335
 RTC registers ... 36, 336
 RTC reset ... 199, 319
 RTCINTREG ... 353
 RTCL1CNTHREG ... 344
 RTCL1CNTLREG ... 343
 RTCL1HREG ... 342
 RTCL1LREG ... 341
 RTCL2CNTHREG ... 348
 RTCL2CNTLREG ... 347
 RTCL2HREG ... 346
 RTCL2LREG ... 345
 RTCLong timer ... 335
 RXB0LREG ... 441
 RXB0RREG ... 440
 RXFL ... 523
 RXIR ... 515
 RXSTS ... 519

S

Scan sequencer ... 383, 425
 SCANLINE ... 434
 SCNTREG ... 413
 SCNVRREG ... 414
 SDMADATREG ... 411
 SEQREG ... 419
 Serial Interface Unit (SIU) ... 32, 461
 Shutdown control ... 320
 SIU ... 32, 461
 SIU registers ... 41, 461
 SIUDLL ... 463
 SIUDLM ... 465
 SIUFC ... 469
 SIUIE ... 464
 SIUIID ... 467
 SIUIRSEL ... 478
 SIULC ... 472
 SIULS ... 474
 SIUMC ... 473
 SIUMS ... 476
 SIURB ... 462
 SIUSC ... 477
 SIUTH ... 462
 Slip conditions ... 114
 SODATREG ... 412
 Soft reset ... 208
 Soft reset exception ... 178
 SOFTINTREG ... 370

Software interrupts ... 232
 Software shutdown ... 203, 320
 Special instructions ... 96
 Stall conditions ... 113
 Standby mode ... 210, 326
 Status after reset ... 164
 Status register ... 162
 Store delay slot ... 82
 Store instruction ... 82, 527
 Supervisor expanded addressing mode ... 211
 Supervisor mode ... 124
 Supervisor mode address space ... 125
 Suspend mode ... 210, 326
 SYSINT1REG ... 295
 SYSINT2REG ... 311
 System Call exception ... 186
 System Control Coprocessor (CP0) ... 44, 49, 141
 System Control Coprocessor (CP0) instructions ... 97, 528

T

TagHi register ... 152
 TagLo register ... 152
 TCLKCNTHREG ... 352
 TCLKCNTLREG ... 351
 TCLKHREG ... 350
 TCLKLREG ... 349
 TClock ... 53
 Tclock Counter ... 335
 TDR ... 502
 TDREG ... 287
 Timer interrupt ... 232
 TLB ... 52, 117
 TLB entry ... 142
 TLB exceptions ... 181
 TLB instructions ... 155
 TLB Invalid exception ... 182
 TLB Misses ... 155
 TLB Modified exception ... 183
 TLB Refill exception ... 181
 Touch panel ... 381
 Touch Panel Interface Unit (PIU) ... 32, 381
 Touch/release detection ... 404
 Translation Lookaside Buffer (TLB) ... 52, 117
 Trap exception ... 188
 TXFL ... 521
 TXIR ... 514
 TXSOLREG ... 443
 TXSORREG ... 442

U

- User expanded addressing mode ... 211
- User mode ... 121
- User mode address space ... 122

V

- Virtual address ... 117
- Virtual-to-physical address translation ... 118

W

- Watch exception ... 189
- WatchHi register ... 168
- WatchLo register ... 168
- Wired register ... 148

X

- XContext register ... 169
- XTLB Refill exception ... 181

Facsimile Message

Although NEC has taken all possible steps to ensure that the documentation supplied to our customers is complete, bug free and up-to-date, we readily accept that errors may occur. Despite all the care and precautions we've taken, you may encounter problems in the documentation. Please complete this form whenever you'd like to report errors or suggest improvements to us.

From:

Name

Company

Tel.

FAX

Address

Thank you for your kind support.

North America

NEC Electronics Inc.
Corporate Communications Dept.
Fax: 1-800-729-9288
1-408-588-6130

Hong Kong, Philippines, Oceania

NEC Electronics Hong Kong Ltd.
Fax: +852-2886-9022/9044

Asian Nations except Philippines

NEC Electronics Singapore Pte. Ltd.
Fax: +65-250-3583

Europe

NEC Electronics (Europe) GmbH
Technical Documentation Dept.
Fax: +49-211-6503-274

Korea

NEC Electronics Hong Kong Ltd.
Seoul Branch
Fax: 02-528-4411

Japan

NEC Corporation
Semiconductor Solution Engineering Division
Technical Information Support Dept.
Fax: 044-548-7900

South America

NEC do Brasil S.A.
Fax: +55-11-6465-6829

Taiwan

NEC Electronics Taiwan Ltd.
Fax: 02-719-5951

I would like to report the following error/make the following suggestion:

Document title: _____

Document number: _____ Page number: _____

If possible, please fax the referenced page or drawing.

Document Rating	Excellent	Good	Acceptable	Poor
Clarity	<input type="checkbox"/>	<input type="checkbox"/>	<input type="checkbox"/>	<input type="checkbox"/>
Technical Accuracy	<input type="checkbox"/>	<input type="checkbox"/>	<input type="checkbox"/>	<input type="checkbox"/>
Organization	<input type="checkbox"/>	<input type="checkbox"/>	<input type="checkbox"/>	<input type="checkbox"/>