

Description

The μ PD41256 is a 262,144-word by 1-bit dynamic RAM designed to operate from a single +5-volt power supply and fabricated with a double polylayer, N-channel, silicon-gate process for high density, high performance, and high reliability. A single-transistor storage cell and advanced dynamic circuitry, including 1024 sense amplifiers, ensure that power dissipation is minimized, while an on-chip circuit generates the negative-voltage substrate bias—automatically and transparently.

The three-state output is controlled by $\overline{\text{CAS}}$ independent of $\overline{\text{RAS}}$. After a valid read or read-modify-write cycle, data is held on the output by holding $\overline{\text{CAS}}$ low. The data output is returned to high impedance by returning $\overline{\text{CAS}}$ high. A hidden refresh feature allows $\overline{\text{CAS}}$ to be held low to maintain output data while $\overline{\text{RAS}}$ is used to execute refresh cycles.

Refreshing may be accomplished by means of $\overline{\text{RAS}}$ -only refresh cycles, hidden refresh cycles, $\overline{\text{CAS}}$ before $\overline{\text{RAS}}$ refresh cycles, or by normal read or write cycles on the 256 address combinations of A_0 through A_7 during a 4-ms refresh period.

Features

- 262,144-word x 1-bit organization
- High-density plastic DIP and PLCC packaging
- Multiplexed address inputs
- Single +5-volt power supply
- On-chip substrate bias generator
- Low power dissipation of 28 mW max (standby)
- Nonlatched, three-state outputs
- Fully TTL-compatible inputs and outputs
- Low input capacitance
- 256 refresh cycles every 4 ms
- Optional page cycle
- $\overline{\text{RAS}}$ -only, hidden, and $\overline{\text{CAS}}$ before $\overline{\text{RAS}}$ refreshing

Pin Configurations

16-Pin Plastic DIP

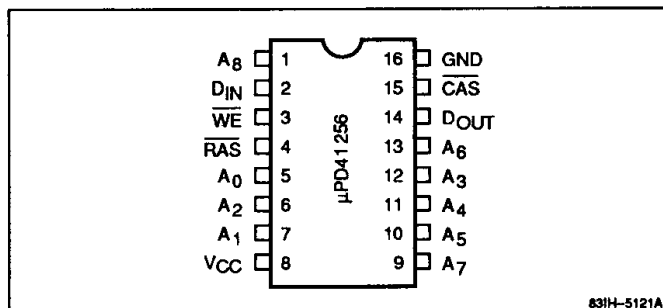

83IH-5121A

18-Pin Plastic Leaded Chip Carrier (PLCC)

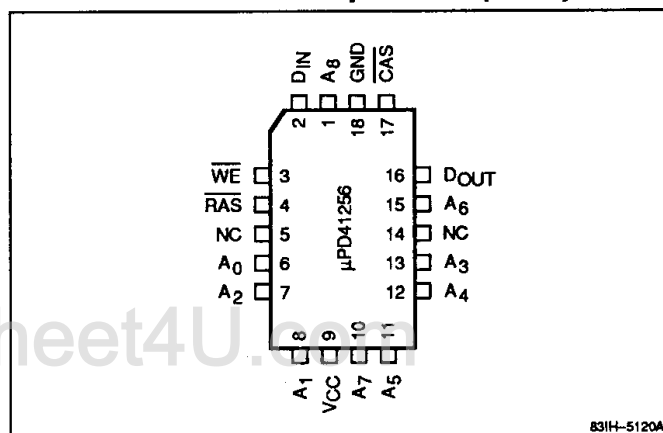

83IH-5120A

3a

μPD41256

Ordering Information

Part Number	Row Access Time (max)	R/W Cycle (min)	Page Cycle (min)	Power Supply Tolerance	Package
μPD41256C-80	80 ns	160 ns	70 ns	±5%	16-pin plastic DIP
C-85	85 ns	165 ns	70 ns		
C-10	100 ns	200 ns	100 ns	±10%	
μPD41256L-80	80 ns	160 ns	70 ns	±5%	18-pin plastic leaded chip carrier
L-85	85 ns	165 ns	70 ns		
L-10	100 ns	200 ns	100 ns	±10%	

Pin Identification

Name	Function
A ₀ - A ₈	Address inputs
CAS	Column address strobe
D _{IN}	Data input
D _{OUT}	Data output
RAS	Row address strobe
WE	Write enable
GND	Ground
V _{CC}	+5-volt power supply
NC	No connection

Capacitance

T_A = 25°C; f = 1 MHz

Parameter	Symbol	Max	Unit	Pins Under Test
Input capacitance	C _{I1}	5	pF	A ₀ - A ₈ , D _{IN}
	C _{I2}	8	pF	RAS, CAS, WE
Output capacitance	C _{OUT}	7	pF	D _{OUT}

DC Characteristics

T_A = 0 to +70°C; V_{CC} = +5.0 V ±10%

Parameter	Symbol	Min	Max	Unit	Test Conditions
Standby supply current	I _{CC2}		5.0	mA	RAS = V _{IH} ; D _{OUT} = high impedance
Input leakage current	I _{I(L)}	-10	10	μA	V _{IN} = 0 V to V _{CC} ; all other pins not under test = 0 V
Output leakage current	I _{O(L)}	-10	10	μA	D _{OUT} disabled; V _{OUT} = 0 V to V _{CC}
Output voltage, low	V _{OL}		0.4	V	I _{OL} = 4.2 mA
Output voltage, high	V _{OH}	2.4		V	I _{OUT} = -5 mA

Absolute Maximum Ratings

Voltage on any pin relative to GND, V _T	-1.0 to +7.0 V
Operating temperature, T _A (ambient)	0 to +70°C
Storage temperature, T _{STG}	-55 to +125°C
Short-circuit output current, I _{OS}	50 mA
Power dissipation, P _D	1.0 W

Exposure to Absolute Maximum Ratings for extended periods may affect device reliability; exceeding the ratings could cause permanent damage. The device should be operated within the limits specified under DC and AC Characteristics.

Recommended Operating Conditions

Parameter	Symbol	Min	Typ	Max	Unit
Supply voltage	V _{CC}	4.5	5.0	5.5	V
Input voltage, high	V _{IH}	2.4		V _{CC} + 1.0	V
Input voltage, low	V _{IL}	-1.0		0.8	V
Ambient temperature	T _A	0		70	°C

Notes:

(1) V_{CC} = +5 V ±5% for the -80 and -85 versions.

Block Diagram

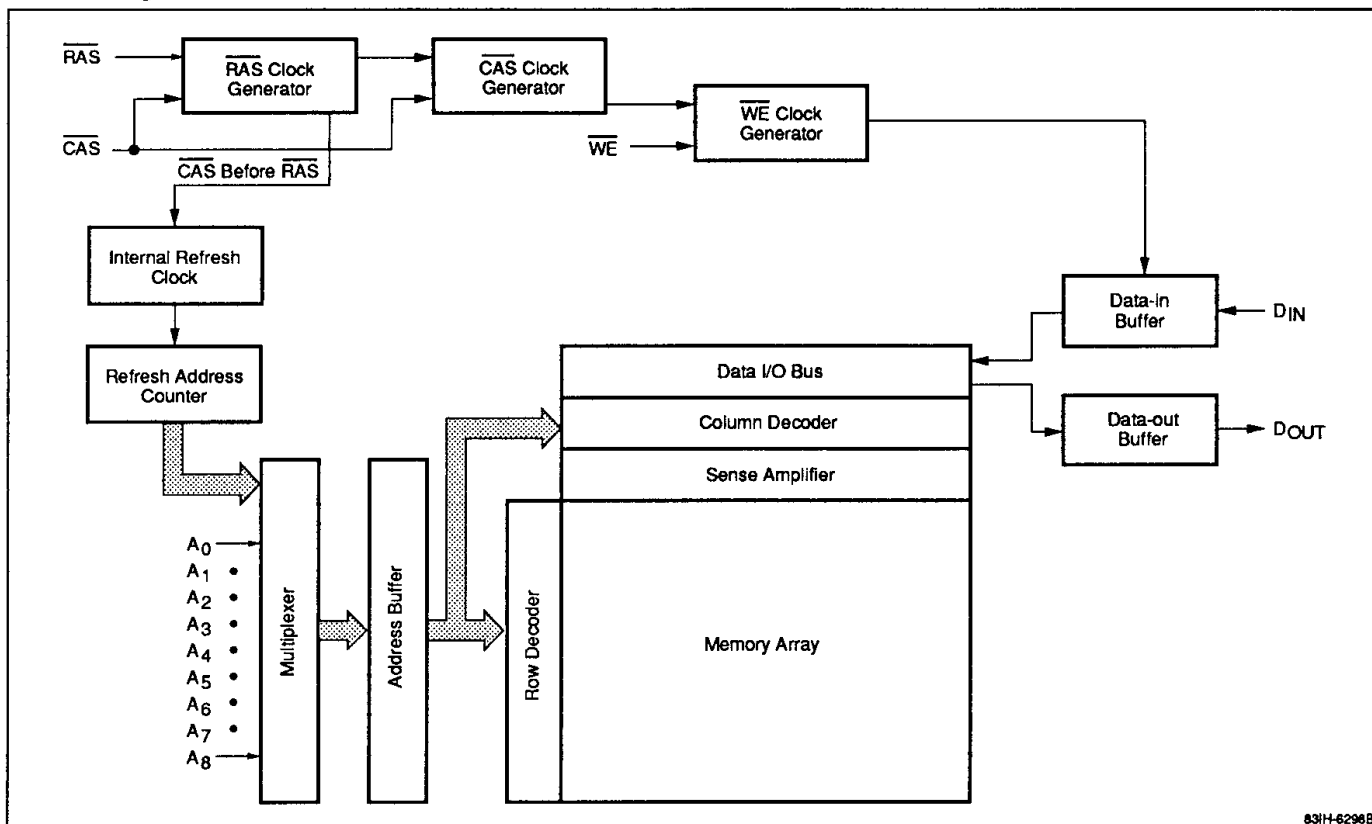

83H-6298B

3a

AC Characteristics

 $T_A = 0 \text{ to } +70^\circ\text{C}$

Parameter	Symbol	μPD41256-80		μPD41256-85		μPD41256-10		Unit	Test Conditions
		Min	Max	Min	Max	Min	Max		
Supply voltage	V_{CC}	4.75	5.25	4.75	5.25	4.5	5.5		
Operating supply current, average	I_{CC1}		90		90		80	mA	\overline{RAS} , \overline{CAS} cycling; $t_{RC} = t_{RC}(\text{min})$; $I_O = 0 \text{ mA}$ (Note 5)
Operating supply current, RAS-only refresh cycle, average	I_{CC3}		80		80		65	mA	\overline{RAS} cycling; $\overline{CAS} \geq V_{IH}$; $t_{RC} = t_{RC}(\text{min})$; $I_O = 0 \text{ mA}$ (Note 5)
Operating supply current, page cycle, average	I_{CC4}		70		70		60	mA	$\overline{RAS} \leq V_{IL}$; \overline{CAS} cycling; $t_{PC} = t_{PC}(\text{min})$; $I_O = 0 \text{ mA}$ (Note 5)
Operating current, \overline{CAS} before \overline{RAS} refresh cycle, average	I_{CC5}		80		80		65	mA	$\overline{CAS} \leq V_{IL}$; \overline{RAS} cycling; $t_{RC} = t_{RC}(\text{min})$; $I/O = 0 \text{ mA}$ (Note 5)
Random read or write cycle time	t_{RC}	180		165		200		ns	(Note 6)
Read-write cycle time	t_{RWC}	185		195		240		ns	(Note 6)
Page cycle time	t_{PC}	70		70		100		ns	(Note 6)
Access time from \overline{RAS}	t_{RAC}		80		85		100	ns	(Notes 7, 8)
Access time from \overline{CAS}	t_{CAC}		40		40		50	ns	(Notes 7, 9)

μPD41256

AC Characteristics (cont)

Parameter	Symbol	μPD41256-80		μPD41256-85		μPD41256-10		Unit	Test Conditions
		Min	Max	Min	Max	Min	Max		
Output buffer turnoff delay	t_{OFF}	0	20	0	20	0	25	ns	(Note 10)
Rise and fall transition time	t_T	3	50	3	50	3	50	ns	(Note 4)
\overline{RAS} precharge time	t_{RP}	70		70		90		ns	
\overline{RAS} pulse width	t_{RAS}	80	16,000	85	16,000	100	10,000	ns	
\overline{RAS} hold time	t_{RSH}	40		40		50		ns	
\overline{CAS} pulse width	t_{CAS}	40	10,000	40	10,000	50	10,000	ns	
\overline{CAS} hold time	t_{CSH}	80		85		100		ns	
\overline{RAS} to \overline{CAS} delay time	t_{RCD}	20	40	20	45	20	50	ns	(Note 11)
\overline{CAS} to \overline{RAS} precharge time	t_{CRP}	10		10		10		ns	(Note 12)
\overline{CAS} precharge time, nonpage cycle	t_{CPN}	25		25		25		ns	
\overline{CAS} precharge time, page cycle	t_{CP}	20		20		40		ns	
\overline{RAS} precharge \overline{CAS} hold time	t_{RPC}	0		0		0		ns	
Row address setup time	t_{ASR}	0		0		0		ns	
Row address hold time	t_{RAH}	10		10		10		ns	
Column address setup time	t_{ASC}	0		0		0		ns	
Column address hold time	t_{CAH}	15		20		15		ns	
Column address hold time referenced to \overline{RAS}	t_{AR}	55		65		65		ns	
Read command setup time	t_{RCS}	0		0		0		ns	
Read command hold time referenced to \overline{RAS}	t_{RRH}	10		10		10		ns	(Note 13)
Read command hold time referenced to \overline{CAS}	t_{RCH}	0		0		0		ns	(Note 13)
Write command hold time	t_{WCH}	20		20		25		ns	
Write command hold time referenced to \overline{RAS}	t_{WCR}	60		65		75		ns	
Write command pulse width	t_{WP}	20		15		15		ns	(Note 17)
Write command to \overline{RAS} lead time	t_{RWL}	20		30		35		ns	
Write command to \overline{CAS} lead time	t_{CWL}	20		30		35		ns	
Data-in setup time	t_{DS}	0		0		0		ns	(Note 14)
Data-in hold time	t_{DH}	20		20		25		ns	(Note 14)
Data-in hold time referenced to \overline{RAS}	t_{DHR}	60		65		75		ns	
Refresh period	t_{REF}		4		4		4	ms	Addresses $A_0 - A_7$
\overline{WE} command setup time	t_{WCS}	0		0		0		ns	(Note 15)
\overline{CAS} to \overline{WE} delay	t_{CWD}	40		40		50		ns	(Note 15)
\overline{RAS} to \overline{WE} delay	t_{RWD}	80		85		100		ns	(Note 15)
\overline{CAS} setup time for \overline{CAS} before \overline{RAS} refresh cycle	t_{CSR}	10		10		10		ns	(Note 16)

AC Characteristics (cont)

Parameter	Symbol	μPD41256-80		μPD41256-85		μPD41256-10		Unit	Test Conditions
		Min	Max	Min	Max	Min	Max		
CAS hold time for CAS before RAS refresh cycle	t _{CHR}	20		15		20		ns	(Note 16)
Read-write cycle time (counter test cycle)	t _{TRC}	N/A		N/A		220		ns	(Note 18)
Read-write cycle time (counter test cycle)	t _{TRWC}	N/A		N/A		260		ns	(Note 18)

Notes:

- (1) All voltages are referenced to GND.
- (2) An initial pause of 100 μs is required after power-up, followed by any eight RAS cycles, before proper device operation is achieved.
- (3) AC measurements assume t_T = 5 ns.
- (4) V_{IH} (min) and V_{IL} (max) are reference levels for measuring the timing of input signals. Transition times are measured between V_{IH} and V_{IL}.
- (5) I_{CC1}, I_{CC3}, I_{CC4}, and I_{CC5} depend on output loading and cycle rates. Specified values are obtained with the output open.
- (6) The minimum specifications are used only to indicate the cycle time at which proper operation over the full temperature range (T_A = 0 to +70°C) is assured.
- (7) Output load = 2 TTL loads and 100 pF
- (8) Assumes that t_{RCD} ≤ t_{RCD} (max). If t_{RCD} is greater than the maximum recommended value shown in this table, t_{RAC} will increase by the amount that t_{RCD} exceeds the value shown.
- (9) Assumes that t_{RCD} ≥ t_{RCD} (max)
- (10) t_{OFF} (max) defines the time at which the output achieves the open-circuit condition and is not referenced to V_{OH} or V_{OL}.
- (11) Operation within the t_{RCD} (max) limit assures that t_{RAC} (max) can be met. t_{RCD} (max) is specified as a reference point only. If t_{RCD} is greater than the specified t_{RCD} (max) limit, then access time is controlled exclusively by t_{CAC}.
- (12) The t_{CRP} requirement should be applicable for RAS/CAS cycles preceded by any cycle.
- (13) Either t_{RRH} or t_{RCH} must be satisfied for a read cycle.
- (14) These parameters are referenced to the leading edge of CAS in early write cycles and to the leading edge of WE in delayed write or read-modify-write cycles.
- (15) t_{WCS}, t_{CWD}, and t_{RWD} are restrictive operating parameters in read-write and read-modify-write cycles only. If t_{WCS} ≥ t_{WCS} (min), the cycle is an early write cycle and the data output will remain open-circuit throughout the entire cycle. If t_{CWD} ≥ t_{CWD} (min) and t_{RWD} ≥ t_{RWD} (min), the cycle is a read-write cycle and the data output will contain data read from the selected cell. If neither of the above conditions is met, the condition of the data output (at access time and until CAS goes back to V_{IH}) is indeterminate.
- (16) DIP products with process codes E, K, P and X do not have the CAS before RAS refresh feature. All other package types and process codes do have CAS before RAS refreshing.
On DIP products with process codes E, K, P and X, the external address inputs are required in hidden refresh cycles and the address timing must satisfy t_{ASR} and t_{RAH}, which are specified with respect to the falling edge of RAS.
- (17) t_{WP} is applicable for a delayed write cycle. If the cycle is early write, it should be satisfied with the specified value of t_{WCH}.
- (18) t_{TRC} and t_{TRWL} are applicable for a CAS before RAS refresh counter test cycle.

3a

μ PD41256

Timing Waveforms

Read Cycle

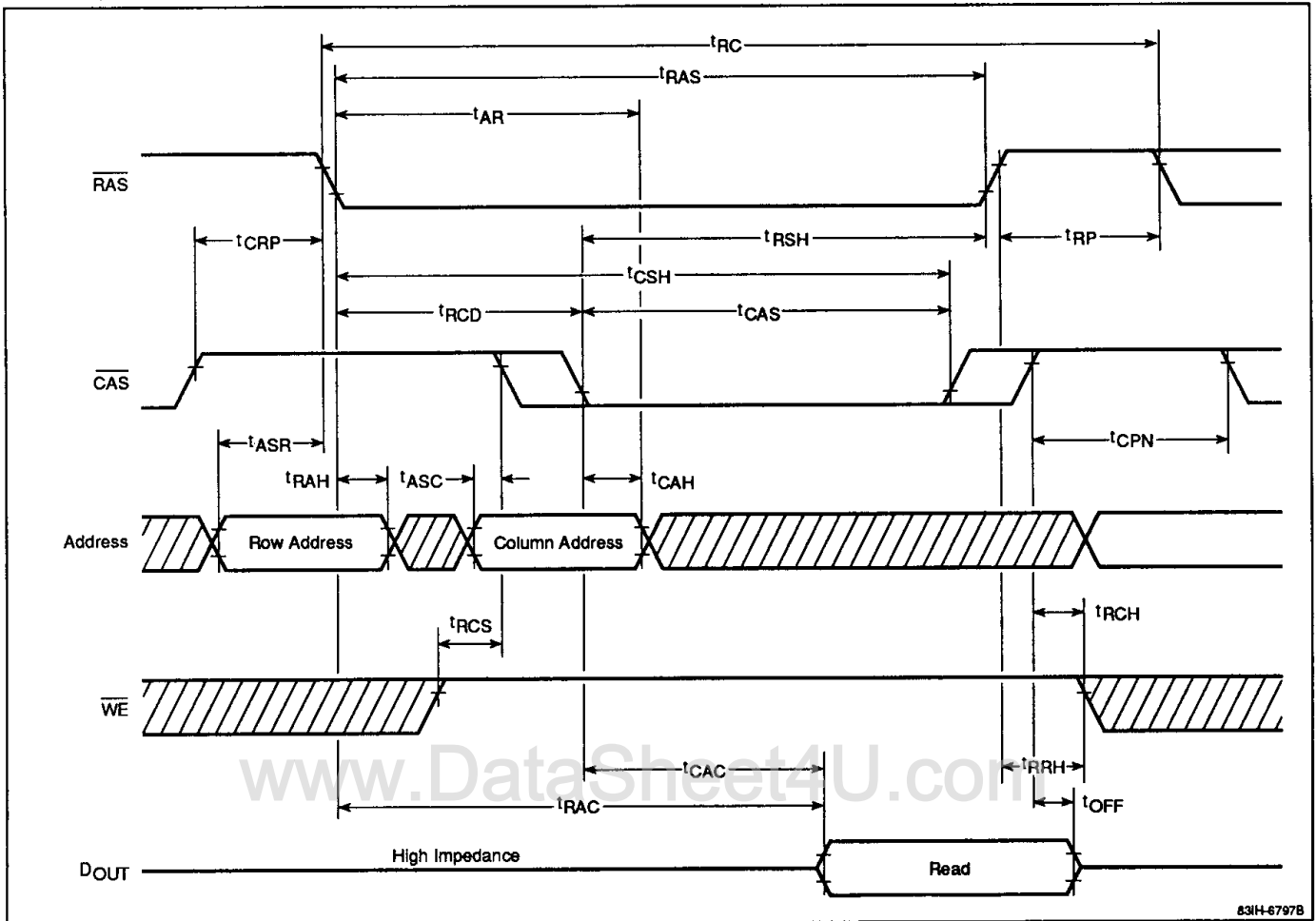

Timing Waveforms (cont)

Early Write Cycle

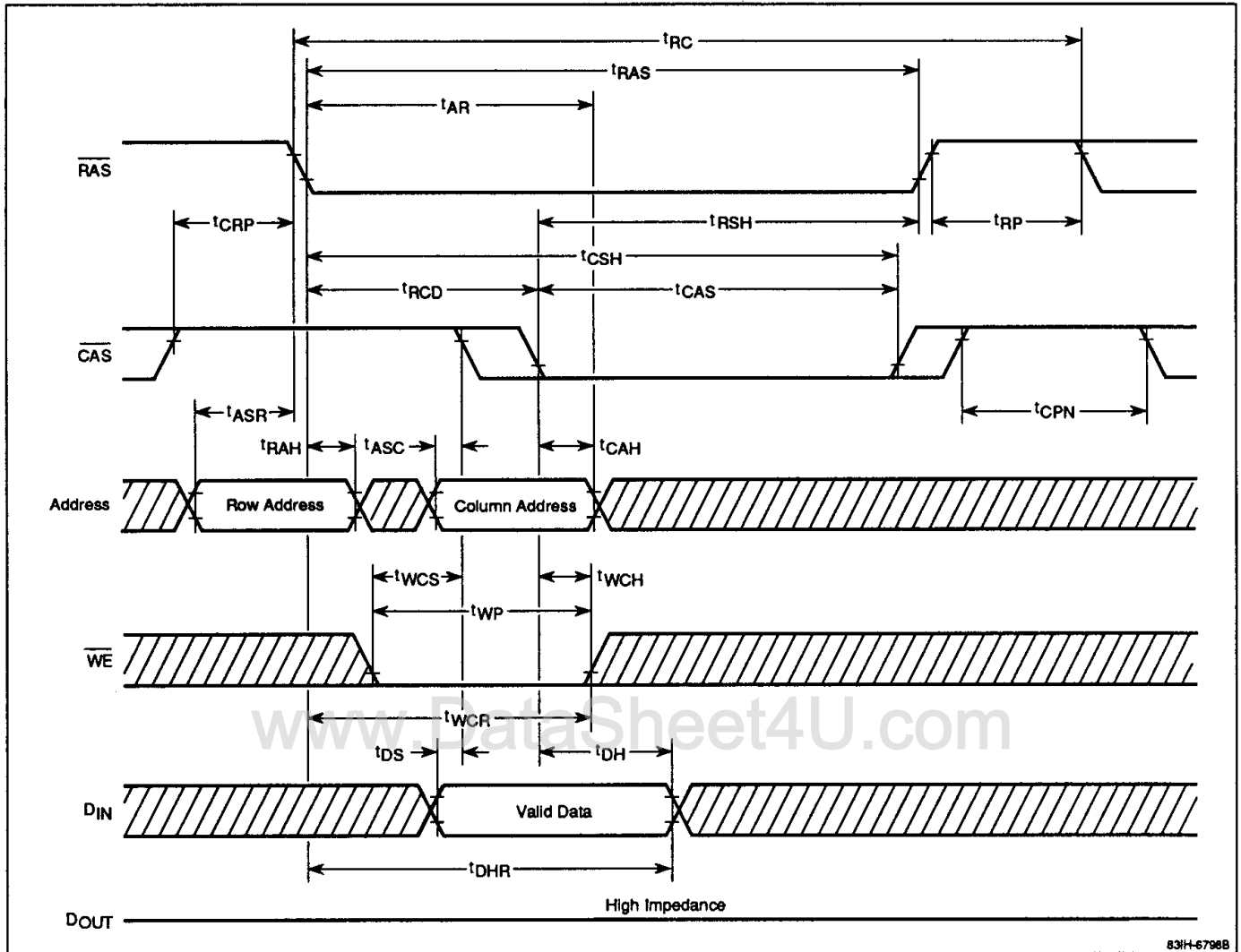

3a

μPD41256

Timing Waveforms (cont)

Hidden Refresh Cycle

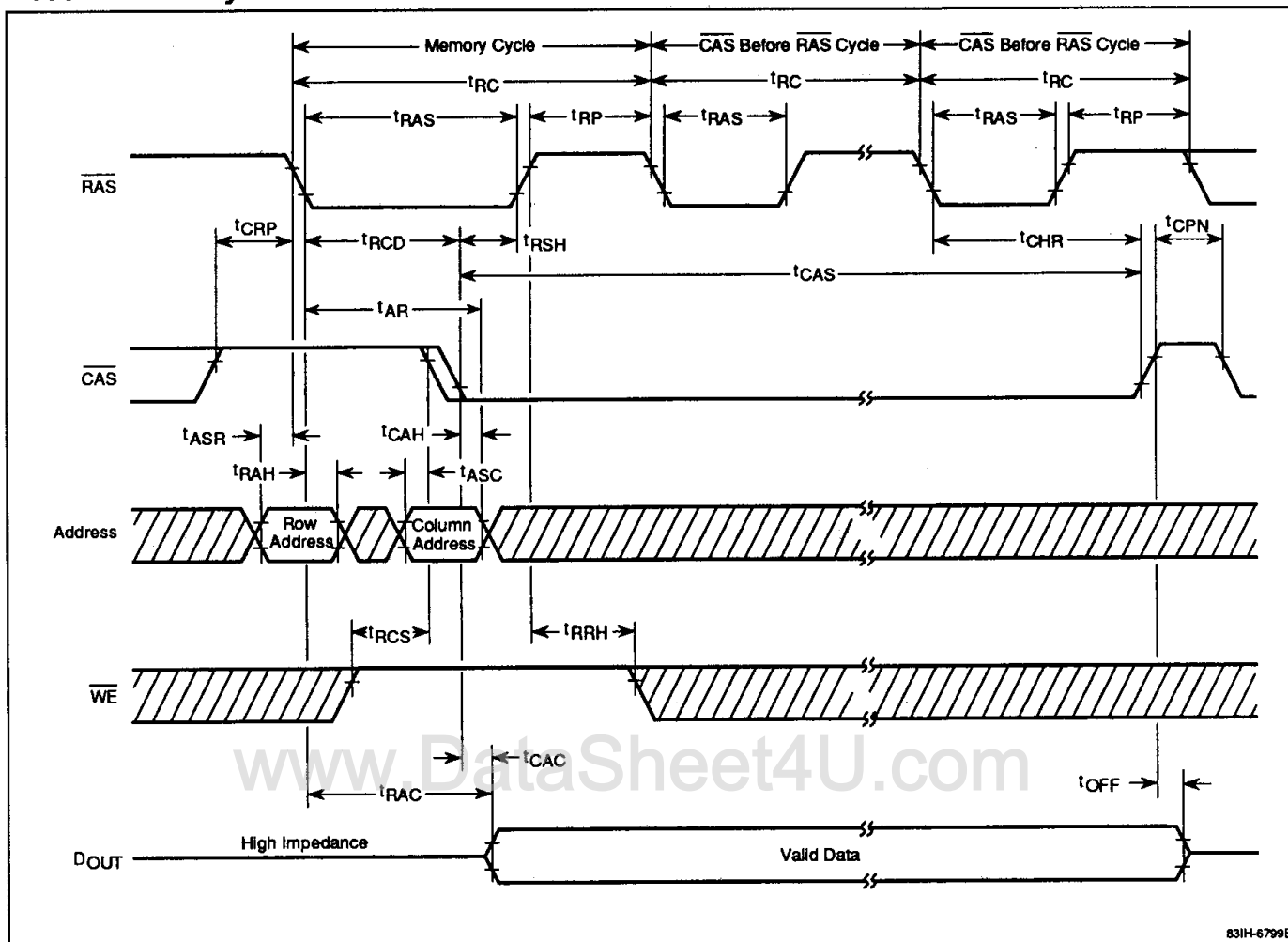

831H-6799B

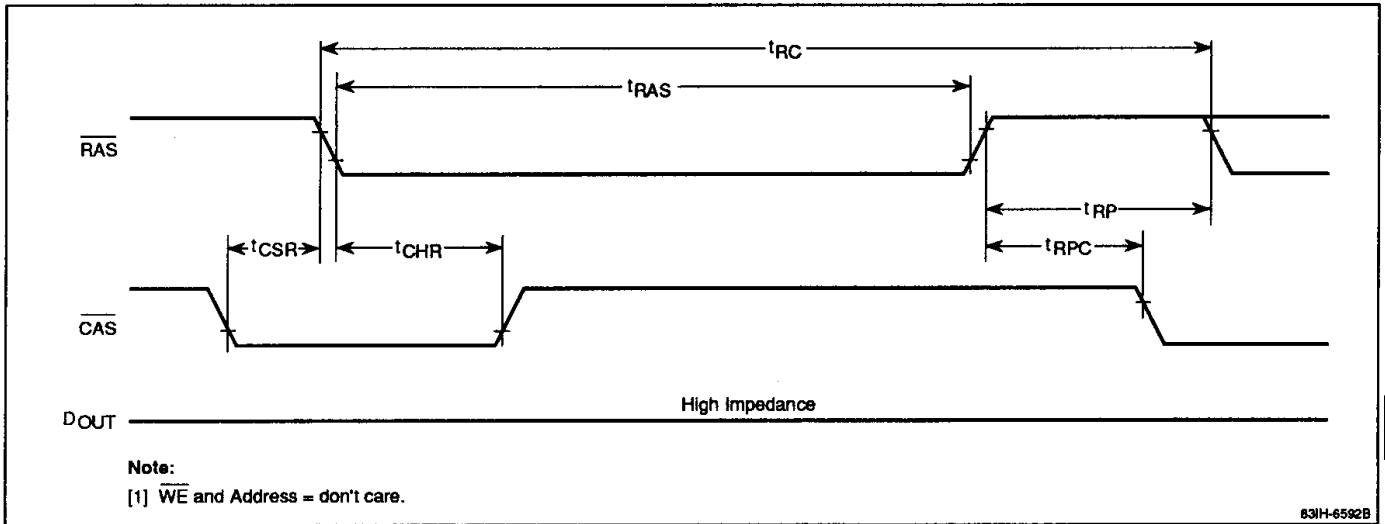
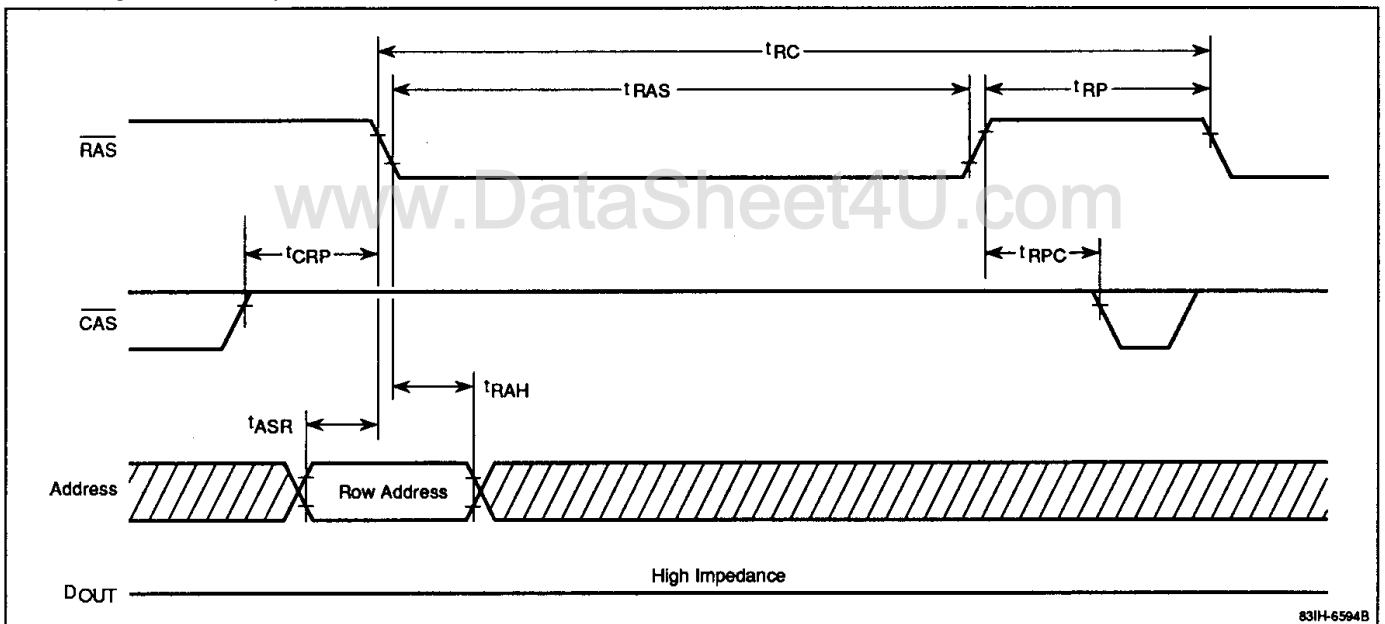
Timing Waveforms (cont) **$\overline{\text{CAS}}$ Before $\overline{\text{RAS}}$ Refresh Cycle****3a** **$\overline{\text{RAS}}$ -Only Refresh Cycle****3A-9**

μPD41256

Timing Waveforms (cont)

Read-Write/Read-Modify-Write Cycle

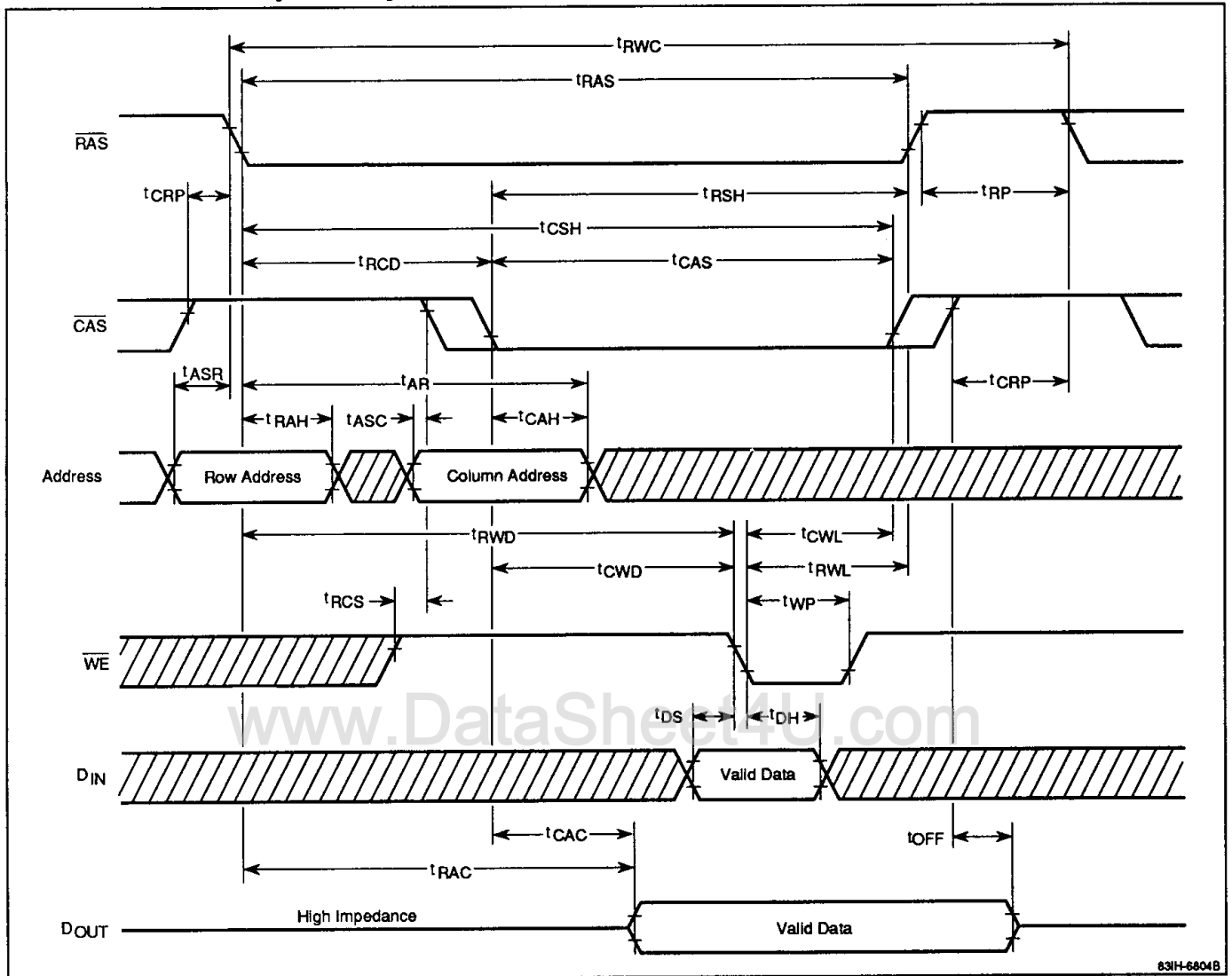

831H-6804B

Timing Waveforms (cont)

Page Read Cycle

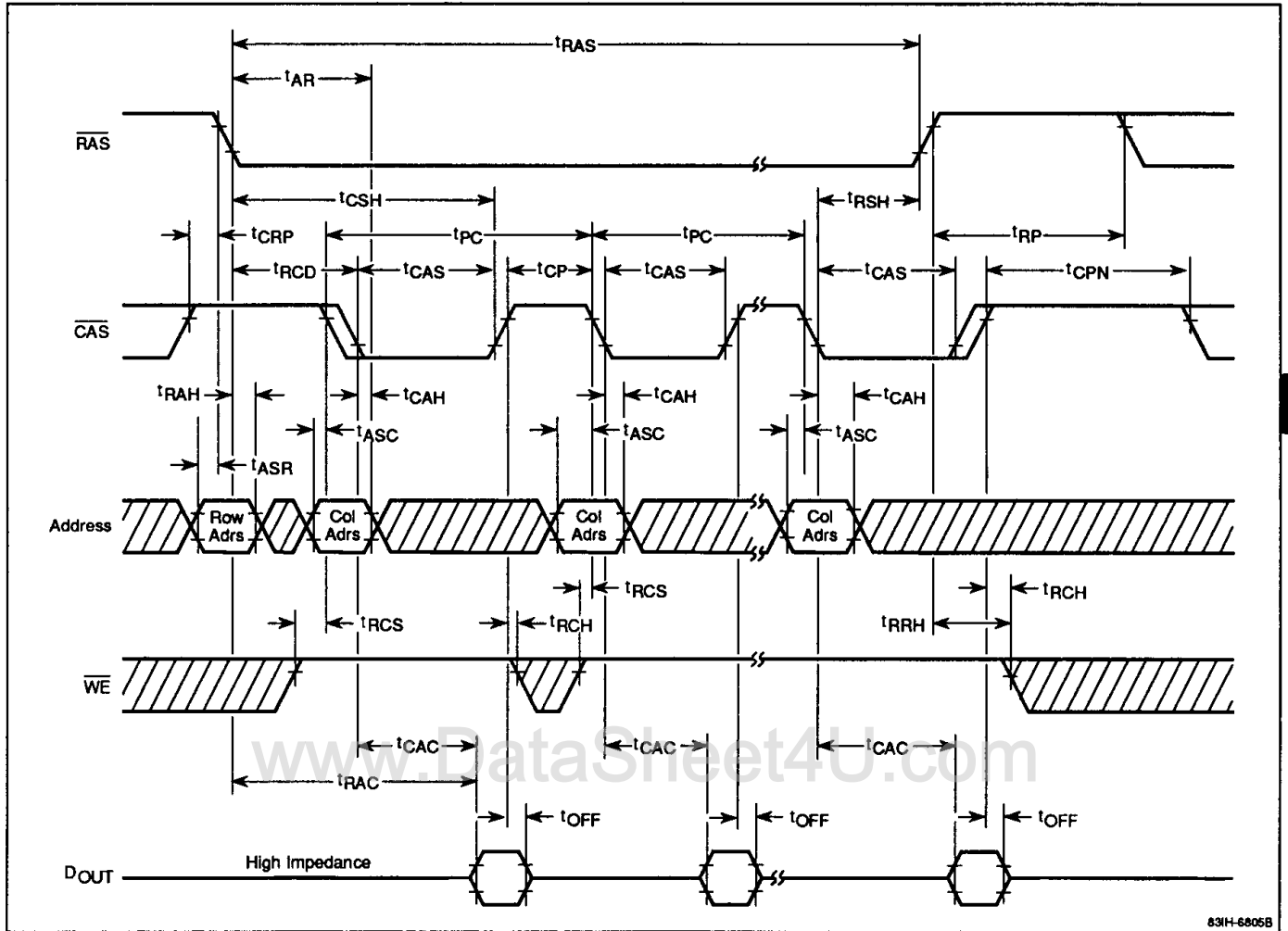

3a

831H-6805B

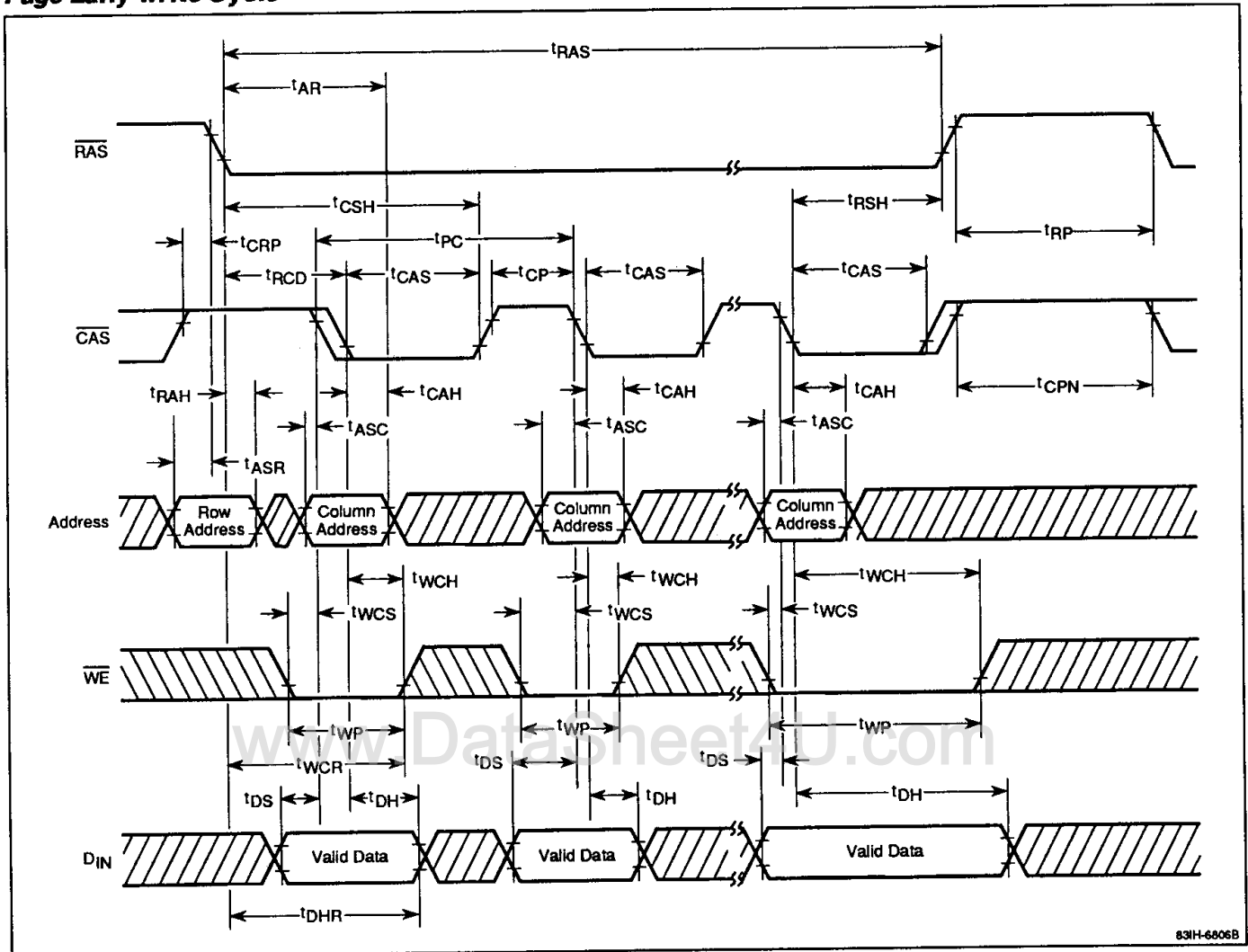
Timing Waveforms (cont)**Page Early Write Cycle**

Timing Waveforms (cont)

Page Read-Write/Read-Modify-Write Cycle

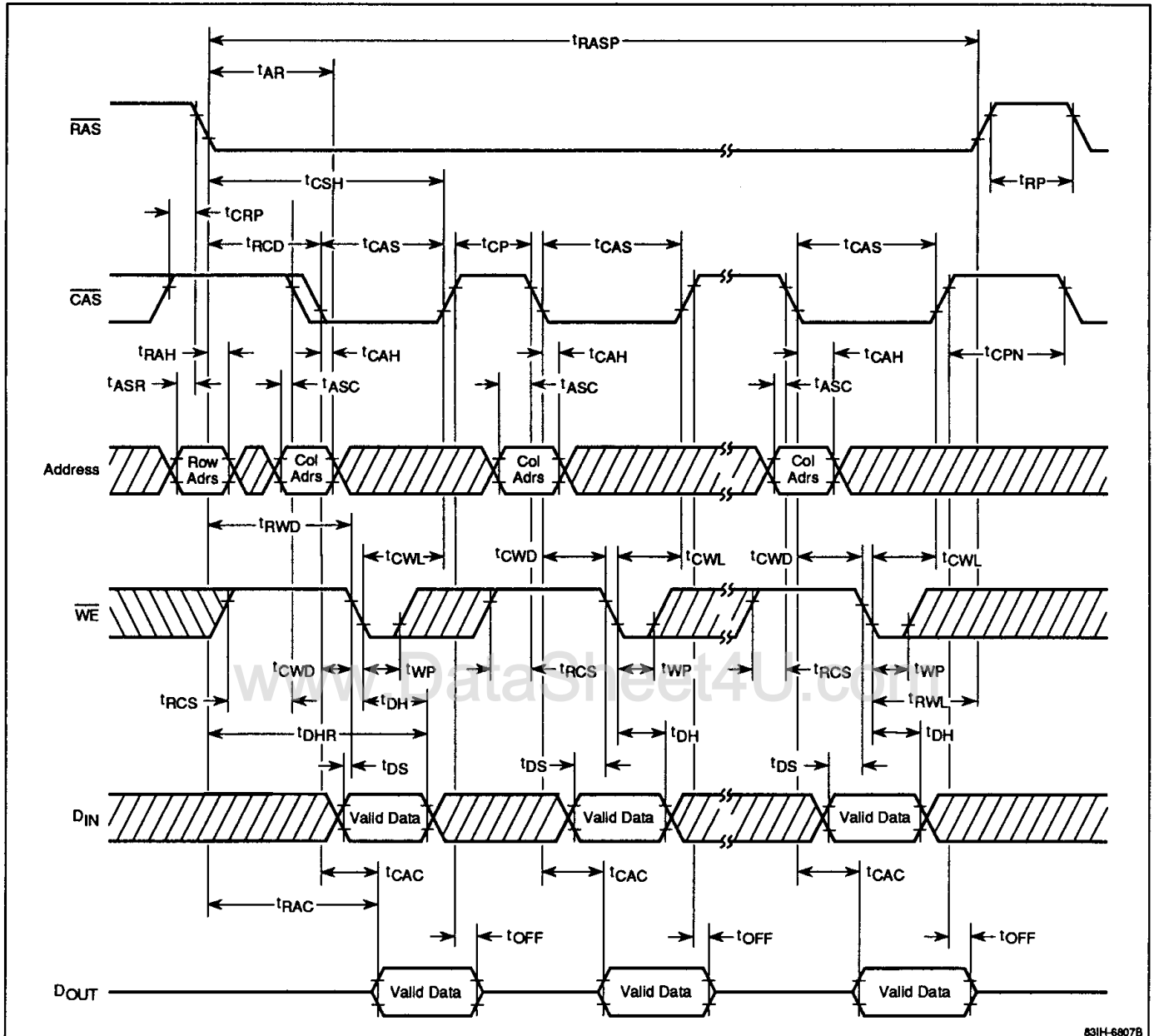

μ PD41256 **$\overline{\text{CAS}}$ Before $\overline{\text{RAS}}$ Refresh Counter Test**

The μ PD41256 provides a method to verify proper operation of the internal address counter used in $\overline{\text{CAS}}$ before $\overline{\text{RAS}}$ refreshing. After a $\overline{\text{CAS}}$ before $\overline{\text{RAS}}$ refresh cycle is initiated, $\overline{\text{CAS}}$ satisfies a hold time (t_{CHR}), a precharge time (t_{CP}), and then returns low while $\overline{\text{RAS}}$ is held low to enable read, write, or read-modify-write operation. As shown in the appropriate timing waveforms, a refresh counter test can be initiated at this point on specified row and column addresses. The row is selected by the internal address counter, and the column is defined by an external address supplied at the second falling edge of $\overline{\text{CAS}}$. Test patterns can be generated in several ways; the following example is one possibility. Any pattern must be preceded by the normal power-up procedure containing a pause of 100 μs and then eight $\overline{\text{RAS}}$ cycles to initialize the internal counter.

- (1) Write "0" into 256 memory cells with 256 $\overline{\text{CAS}}$ before $\overline{\text{RAS}}$ refresh counter test write cycles. Use the same column address in each cycle.
- (2) Use a counter test read-modify-write cycle to read the "0" written in the first cycle of step 1 and then write a "1" into that location in the same cycle. Perform this operation 256 times, until a "1" is written into each of the 256 memory cells. Continue using the same column address as specified in step 1.
- (3) Read each "1" written in step 2 using a counter test read cycle.
- (4) Complement the test pattern and repeat steps 1, 2, and 3.

www.DataSheet4U.com

Timing Waveforms (cont)

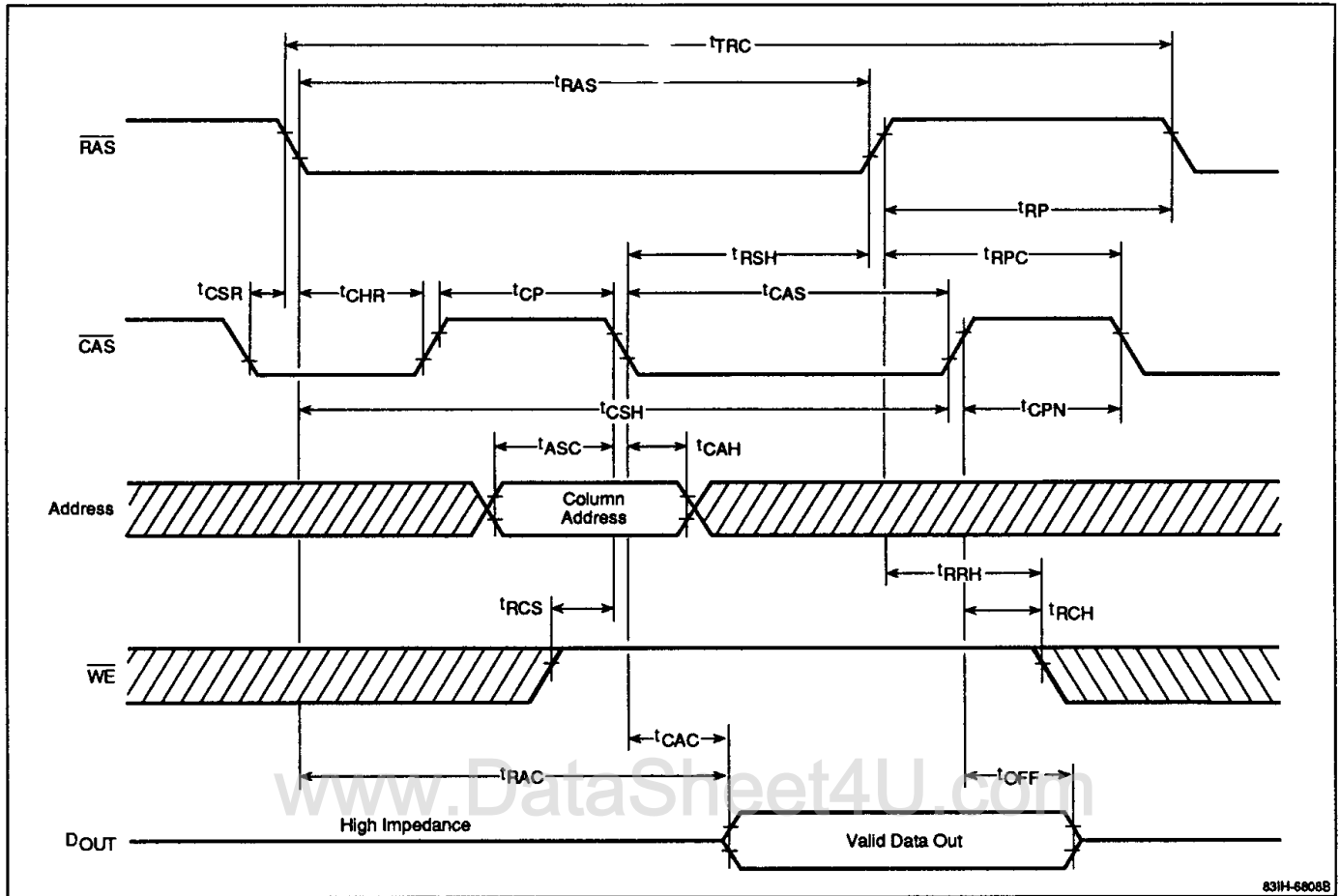
 $\overline{\text{CAS}}$ Before $\overline{\text{RAS}}$ Refresh Counter Test Read Cycle

3a

μ PD41256

Timing Waveforms (cont)

$\overline{\text{CAS}}$ Before $\overline{\text{RAS}}$ Refresh Counter Test Write Cycle

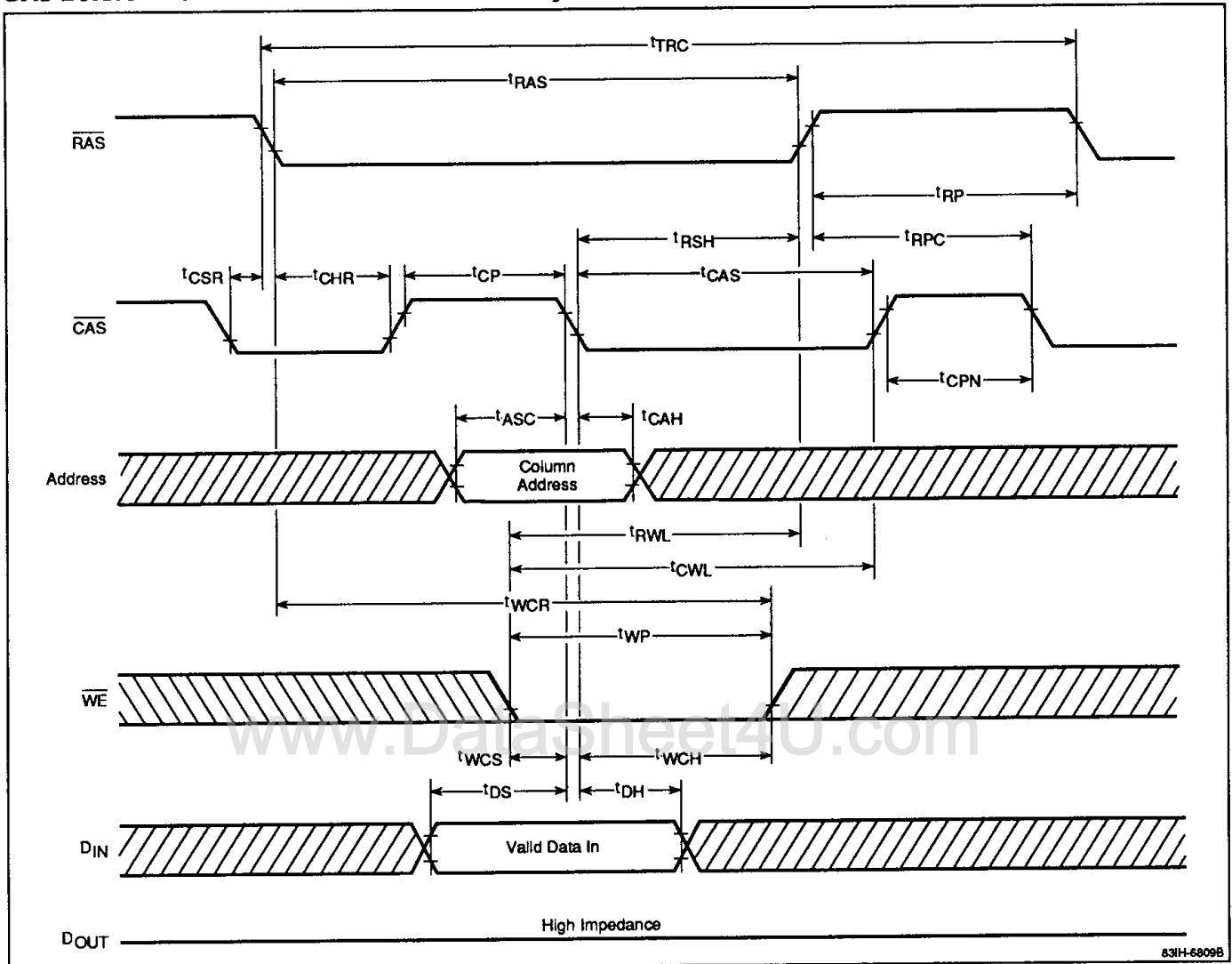

Timing Waveforms (cont)

CAS Before RAS Refresh Counter Test Read-Modify-Write Cycle

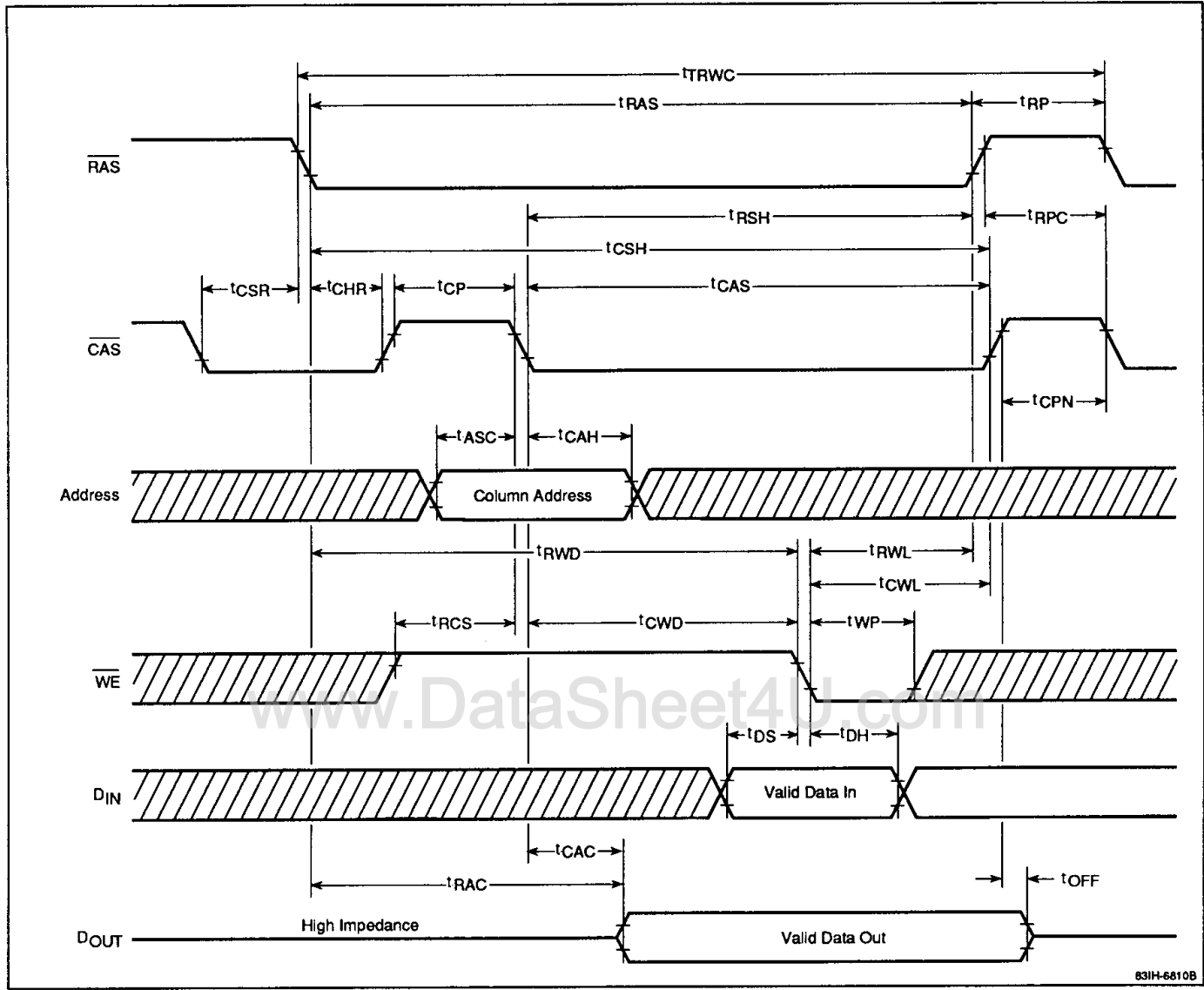

3a