

μ PD42S16165L, 4216165L3.3 V OPERATION 16 M-BIT DYNAMIC RAM
1 M-WORD BY 16-BIT, EDO, BYTE READ/WRITE MODE,**Description**

The μ PD42S16165L, 4216165L are 1,048,576 words by 16 bits CMOS dynamic RAMs with optional EDO.

EDO is a kind of the page mode and is useful for the read operation.

Besides, the μ PD42S16165L can execute $\overline{\text{CAS}}$ before $\overline{\text{RAS}}$ self refresh.

The μ PD42S16165L, 4216165L are packaged in 50-pin plastic TSOP (II) and 42-pin plastic SOJ.

Features

- EDO (Hyper page mode)
- 1,048,576 words by 16 bits organization
- Single +3.3 V \pm 0.3 V power supply
- Fast access and cycle time

Part number	Power consumption Active (MAX.)	Access time (MAX.)	R/W cycle time (MIN.)	EDO (Hyper page mode) cycle time (MIN.)
μ PD42S16165L-A50, 4216165L-A50	432 mW	50 ns	84 ns	20 ns
μ PD42S16165L-A60, 4216165L-A60	396 mW	60 ns	104 ns	25 ns
μ PD42S16165L-A70, 4216165L-A70	360 mW	70 ns	124 ns	30 ns

★

- The μ PD42S16165L can execute $\overline{\text{CAS}}$ before $\overline{\text{RAS}}$ self refresh

Part number	Refresh cycle	Refresh	Power consumption at standby (MAX.)
μ PD42S16165L	4,096 cycles/128 ms	$\overline{\text{CAS}}$ before $\overline{\text{RAS}}$ self refresh, $\overline{\text{CAS}}$ before $\overline{\text{RAS}}$ refresh, $\overline{\text{RAS}}$ only refresh, Hidden refresh	0.54 mW (CMOS level input)
μ PD4216165L	4,096 cycles/64 ms	$\overline{\text{CAS}}$ before $\overline{\text{RAS}}$ refresh, $\overline{\text{RAS}}$ only refresh, Hidden refresh	1.8 mW (CMOS level input)

The information in this document is subject to change without notice.

★ Ordering Information

Part number	Access time (MAX.)	Package	Refresh
μPD42S16165LG5-A50-7JF	50 ns	50-pin plastic TSOP (II) (400 mil)	$\overline{\text{CAS}}$ before $\overline{\text{RAS}}$ self refresh $\overline{\text{CAS}}$ before $\overline{\text{RAS}}$ refresh $\overline{\text{RAS}}$ only refresh Hidden refresh
μPD42S16165LG5-A60-7JF	60 ns		
μPD42S16165LG5-A70-7JF	70 ns		
μPD42S16165LLE-A50	50 ns	42-pin plastic SOJ (400 mil)	
μPD42S16165LLE-A60	60 ns		
μPD42S16165LLE-A70	70 ns		
μPD4216165LG5-A50-7JF	50 ns	50-pin plastic TSOP (II) (400 mil)	$\overline{\text{CAS}}$ before $\overline{\text{RAS}}$ refresh $\overline{\text{RAS}}$ only refresh Hidden refresh
μPD4216165LG5-A60-7JF	60 ns		
μPD4216165LG5-A70-7JF	70 ns		
μPD4216165LLE-A50	50 ns	42-pin plastic SOJ (400 mil)	
μPD4216165LLE-A60	60 ns		
μPD4216165LLE-A70	70 ns		

Pin Configurations (Marking Side)

50-pin Plastic TSOP (II) (400 mil)

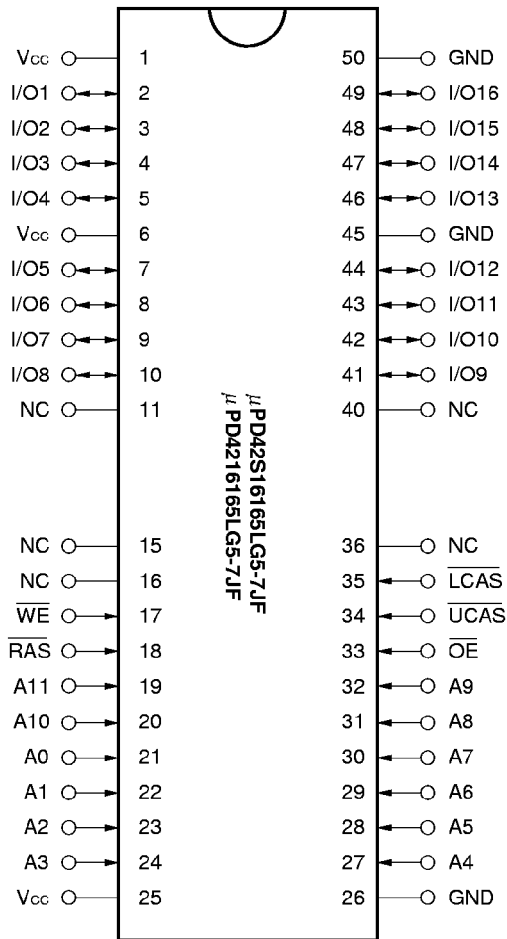

42-pin Plastic SOJ (400 mil)

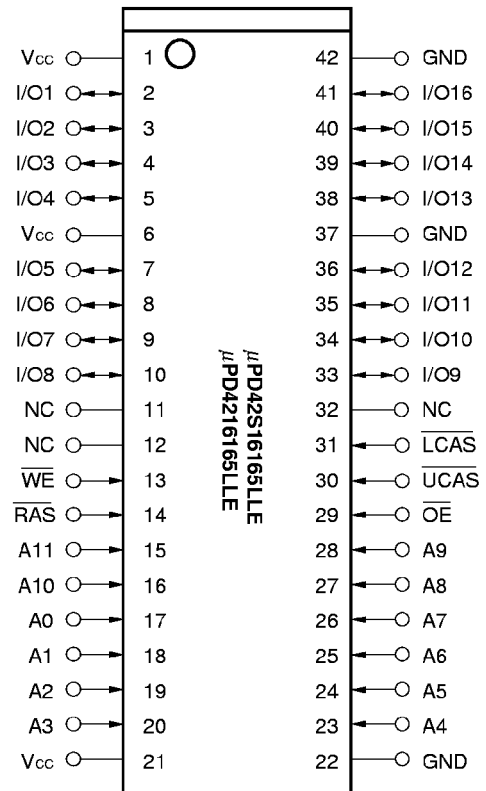

- A0 to A11 : Address Inputs
- I/O1 to I/O16 : Data Inputs/Outputs
- RAS : Row Address Strobe
- UCAS : Column Address Strobe (upper)
- LCAS : Column Address Strobe (lower)
- WE : Write Enable
- OE : Output Enable
- Vcc : Power Supply
- GND : Ground
- NC : No Connection

Block Diagram

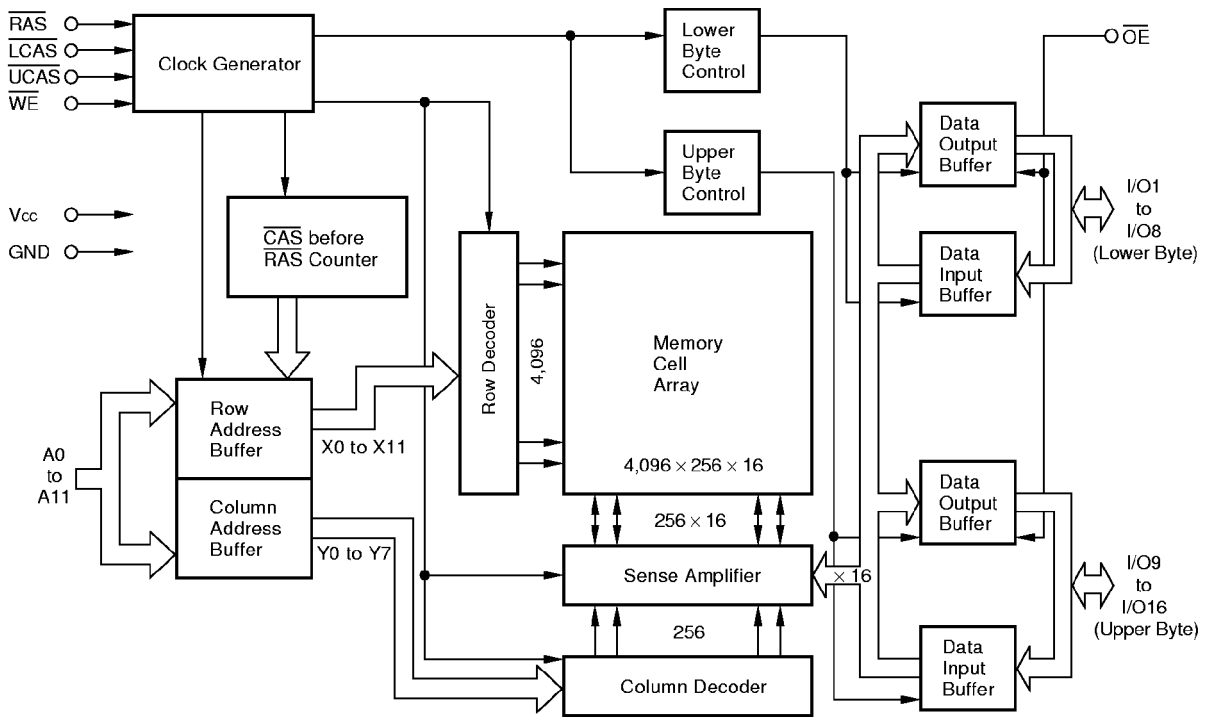

Input/Output Pin Functions

The μPD42S16165L, 4216165L have input pins \overline{RAS} , \overline{CAS} ^{Note}, \overline{WE} , \overline{OE} , A0 to A11 and input/output pins I/O1 to I/O16.

Pin name	Input/Output	Function
\overline{RAS} (Row address strobe)	Input	\overline{RAS} activates the sense amplifier by latching a row address and selecting a corresponding word line. It refreshes memory cell array of one line selected by the row address. It also selects the following function. • \overline{CAS} before \overline{RAS} refresh
\overline{CAS} (Column address strobe)		\overline{CAS} activates data input/output circuit by latching column address and selecting a digit line connected with the sense amplifier.
A0 to A11 (Address inputs)		Address bus. Input total 20-bit of address signal, upper 12-bit and lower 8-bit in sequence (address multiplex method). Therefore, one word is selected from 1,048,576-word by 16-bit memory cell array. In actual operation, latch row address by specifying row address and activating \overline{RAS} . Then, switch the address bus to column address and activate \overline{CAS} . Each address is taken into the device when \overline{RAS} and \overline{CAS} are activated. Therefore, the address input setup time (t_{ASR} , t_{ASC}) and hold time (t_{RAH} , t_{CAH}) are specified for the activation of \overline{RAS} and \overline{CAS} .
\overline{WE} (Write enable)		Write control signal. Write operation is executed by activating \overline{RAS} , \overline{CAS} and \overline{WE} .
\overline{OE} (Output enable)		Read control signal. Read operation can be executed by activating \overline{RAS} , \overline{CAS} and \overline{OE} . If \overline{WE} is activated during read operation, \overline{OE} is to be ineffective in the device. Therefore, read operation cannot be executed.
I/O1 to I/O16 (Data inputs/outputs)	Input/Output	16-bit data bus. I/O1 to I/O16 are used to input/output data.

Note \overline{CAS} means \overline{UCAS} and \overline{LCAS} .

Hyper Page Mode (EDO)

The hyper page mode (EDO) is a kind of page mode with enhanced features. The two major features of the hyper page mode (EDO) are as follows.

1. Data output time is extended.

In the hyper page mode (EDO), the output data is held to the next $\overline{\text{CAS}}$ cycle's falling edge, instead of the rising edge. For this reason, valid data output time in the hyper page mode (EDO) is extended compared with the fast page mode (= data extend function). In the fast page mode, the data output time becomes shorter as the $\overline{\text{CAS}}$ cycle time becomes shorter. Therefore, in the hyper page mode (EDO), the timing margin in read cycle is larger than that of the fast page mode even if the $\overline{\text{CAS}}$ cycle time becomes shorter.

2. The $\overline{\text{CAS}}$ cycle time in the hyper page mode (EDO) is shorter than that in the fast page mode.

In the hyper page mode (EDO), due to the data extend function, the $\overline{\text{CAS}}$ cycle time can be shorter than in the fast page mode if the timing margin is the same.

Taking a device whose t_{RAC} is 60 ns as an example, the $\overline{\text{CAS}}$ cycle time in the fast page mode is 25 ns while that in the hyper page mode is 40 ns.

In the hyper page mode (EDO), read (data out) and write (data in) cycles can be executed repeatedly during one $\overline{\text{RAS}}$ cycle. The hyper page mode (EDO) allows both read and write operations during one cycle.

The following shows a part of the hyper page mode (EDO) read cycle. Specifications to be observed are described in the next page.

Hyper Page Mode (EDO) Read Cycle

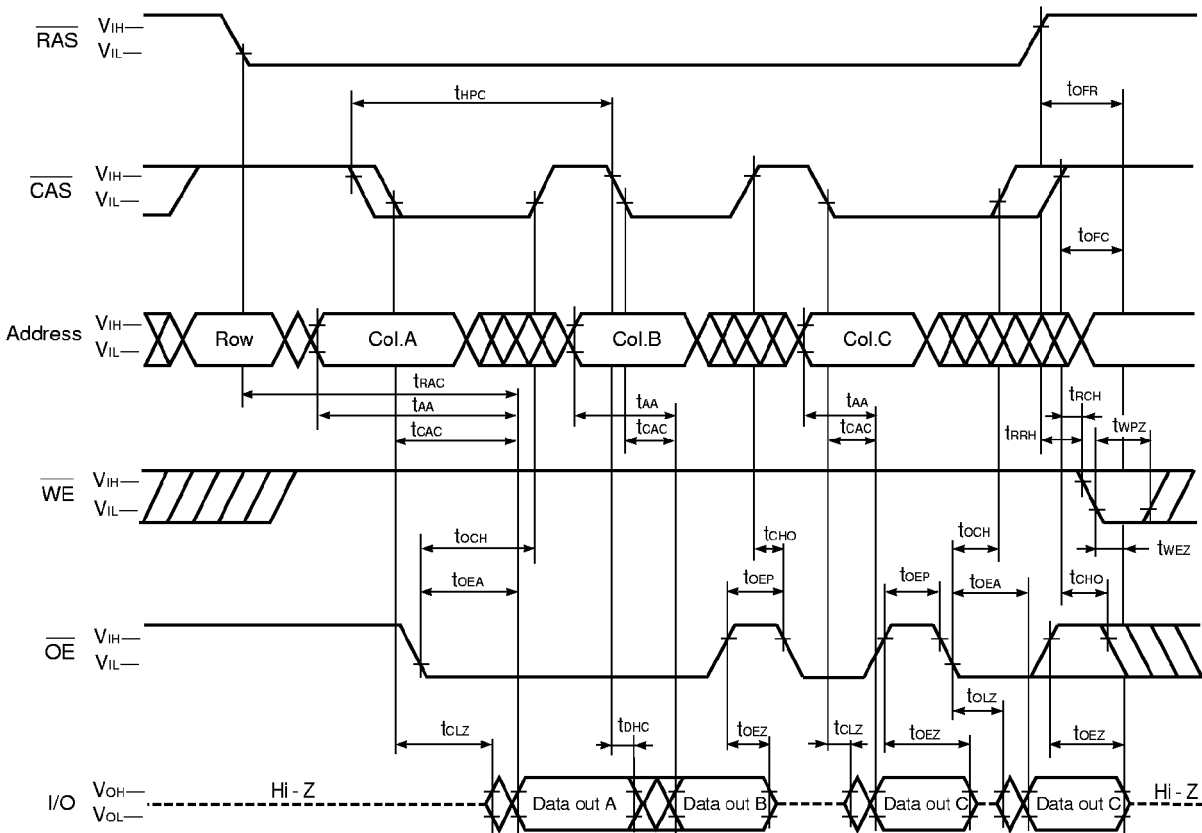

Cautions when using the hyper page mode (EDO)

1. $\overline{\text{CAS}}$ access should be used to operate t_{HPC} at the MIN. value.
2. To make I/Os to Hi-Z in read cycle, it is necessary to control $\overline{\text{RAS}}$, $\overline{\text{CAS}}$, $\overline{\text{WE}}$, $\overline{\text{OE}}$ as follows. The effective specification depends on the state of each signal.
 - (1) Both $\overline{\text{RAS}}$ and $\overline{\text{CAS}}$ are inactive (at the end of read cycle)
 $\overline{\text{WE}}$: inactive, $\overline{\text{OE}}$: active
 t_{OFC} is effective when $\overline{\text{RAS}}$ is inactivated before $\overline{\text{CAS}}$ is inactivated.
 t_{OFR} is effective when $\overline{\text{CAS}}$ is inactivated before $\overline{\text{RAS}}$ is inactivated.
The slower of t_{OFC} and t_{OFR} becomes effective.
 - (2) Both $\overline{\text{RAS}}$ and $\overline{\text{CAS}}$ are active or either $\overline{\text{RAS}}$ or $\overline{\text{CAS}}$ is active (in read cycle)
 $\overline{\text{WE}}$, $\overline{\text{OE}}$: inactive t_{OEZ} is effective.
Both $\overline{\text{RAS}}$ and $\overline{\text{CAS}}$ are inactive or $\overline{\text{RAS}}$ is active and $\overline{\text{CAS}}$ is inactive (at the end of read cycle)
 $\overline{\text{WE}}$, $\overline{\text{OE}}$: active and either t_{RRH} or t_{RCH} must be met t_{WEZ} and t_{WPZ} are effective.
The faster of t_{OEZ} and t_{WEZ} becomes effective.
The faster of (1) and (2) becomes effective.
3. In read cycle, the effective specification depends on the state of $\overline{\text{CAS}}$ signal when controlling data output with the $\overline{\text{OE}}$ signal.
 - (1) $\overline{\text{CAS}}$: inactive, $\overline{\text{OE}}$: active t_{CHO} is effective.
 - (2) $\overline{\text{CAS}}$, $\overline{\text{OE}}$: active t_{CH} is effective.

Electrical Specifications

- $\overline{\text{CAS}}$ means $\overline{\text{UCAS}}$ and $\overline{\text{LCAS}}$.
- All voltages are referenced to GND.
- After power up ($V_{CC} \geq V_{CC(MIN.)}$), wait more than 100 μs ($\overline{\text{RAS}}$, $\overline{\text{CAS}}$ inactive) and then, execute eight $\overline{\text{CAS}}$ before $\overline{\text{RAS}}$ or $\overline{\text{RAS}}$ only refresh cycles as dummy cycles to initialize internal circuit.

Absolute Maximum Ratings

Parameter	Symbol	Condition	Rating	Unit
Voltage on any pin relative to GND	V_T		-0.5 to +4.6	V
Supply voltage	V_{CC}		-0.5 to +4.6	V
Output current	I_O		20	mA
Power dissipation	P_D		1	W
Operating ambient temperature	T_A		0 to +70	°C
Storage temperature	T_{stg}		-55 to +125	°C

Caution Exposing the device to stress above those listed in Absolute Maximum Ratings could cause permanent damage. The device is not meant to be operated under conditions outside the limits described in the operational section of this specification. Exposure to Absolute Maximum Rating conditions for extended periods may affect device reliability.

Recommended Operating Conditions

Parameter	Symbol	Condition	MIN.	TYP.	MAX.	Unit
Supply voltage	V_{CC}		3.0	3.3	3.6	V
High level input voltage	V_{IH}		2.0		$V_{CC} + 0.3$	V
Low level input voltage	V_{IL}		-0.3		+0.8	V
Operating ambient temperature	T_A		0		70	°C

Capacitance ($T_A = 25\text{ °C}$, $f = 1\text{ MHz}$)

Parameter	Symbol	Test condition	MIN.	TYP.	MAX.	Unit
Input capacitance	C_{I1}	Address			5	pF
	C_{I2}	$\overline{\text{RAS}}$, $\overline{\text{CAS}}$, $\overline{\text{WE}}$, $\overline{\text{OE}}$			7	
Data input/output capacitance	$C_{I/O}$	I/O			7	pF

★ DC Characteristics (Recommended operating conditions unless otherwise noted)

Parameter	Symbol	Test condition	MIN.	MAX.	Unit	Notes
Operating current	I _{CC1}	$\overline{\text{RAS}}, \overline{\text{CAS}}$ cycling $t_{\text{RC}} = t_{\text{RC}}(\text{MIN}), I_{\text{O}} = 0 \text{ mA}$	$t_{\text{RAC}} = 50 \text{ ns}$	110	mA	1, 2, 3
			$t_{\text{RAC}} = 60 \text{ ns}$	90		
			$t_{\text{RAC}} = 70 \text{ ns}$	80		
Standby current	μPD42S16165L	$\overline{\text{RAS}}, \overline{\text{CAS}} \geq V_{\text{IH}}(\text{MIN}), I_{\text{O}} = 0 \text{ mA}$ $\overline{\text{RAS}}, \overline{\text{CAS}} \geq V_{\text{CC}} - 0.2 \text{ V}, I_{\text{O}} = 0 \text{ mA}$		0.5	mA	
				0.15		
	μPD4216165L	$\overline{\text{RAS}}, \overline{\text{CAS}} \geq V_{\text{IH}}(\text{MIN}), I_{\text{O}} = 0 \text{ mA}$ $\overline{\text{RAS}}, \overline{\text{CAS}} \geq V_{\text{CC}} - 0.2 \text{ V}, I_{\text{O}} = 0 \text{ mA}$		2.0		
				0.5		
RAS only refresh current	I _{CC3}	$\overline{\text{RAS}}$ cycling, $\overline{\text{CAS}} \geq V_{\text{IH}}(\text{MIN})$ $t_{\text{RC}} = t_{\text{RC}}(\text{MIN}), I_{\text{O}} = 0 \text{ mA}$	$t_{\text{RAC}} = 50 \text{ ns}$	110	mA	1, 2, 3, 4
			$t_{\text{RAC}} = 60 \text{ ns}$	90		
			$t_{\text{RAC}} = 70 \text{ ns}$	80		
Operating current (Hyper page mode (EDO))	I _{CC4}	$\overline{\text{RAS}} \leq V_{\text{IL}}(\text{MAX}), \overline{\text{CAS}}$ cycling $t_{\text{HPC}} = t_{\text{HPC}}(\text{MIN}), I_{\text{O}} = 0 \text{ mA}$	$t_{\text{RAC}} = 50 \text{ ns}$	120	mA	1, 2, 5
			$t_{\text{RAC}} = 60 \text{ ns}$	110		
			$t_{\text{RAC}} = 70 \text{ ns}$	100		
CAS before RAS refresh current	I _{CC5}	$\overline{\text{RAS}}$ cycling $t_{\text{RC}} = t_{\text{RC}}(\text{MIN}), I_{\text{O}} = 0 \text{ mA}$	$t_{\text{RAC}} = 50 \text{ ns}$	110	mA	1, 2
			$t_{\text{RAC}} = 60 \text{ ns}$	90		
			$t_{\text{RAC}} = 70 \text{ ns}$	80		
CAS before RAS long refresh current (4,096 cycles/128 ms, only for the μPD42S16165L)	I _{CC6}	$\overline{\text{CAS}}$ before $\overline{\text{RAS}}$ refresh : $t_{\text{RC}} = 31.3 \mu\text{s}$ $\overline{\text{RAS}}, \overline{\text{CAS}}$: $V_{\text{CC}} - 0.2 \text{ V} \leq V_{\text{IH}} \leq V_{\text{IH}}(\text{MAX})$ $0 \text{ V} \leq V_{\text{IL}} \leq 0.2 \text{ V}$ Standby: $\overline{\text{RAS}}, \overline{\text{CAS}} \geq V_{\text{CC}} - 0.2 \text{ V}$ Address: V_{IH} or V_{IL} $\overline{\text{WE}}, \overline{\text{OE}}: V_{\text{IH}}$ $I_{\text{O}} = 0 \text{ mA}$	$t_{\text{RAS}} \leq 300 \text{ ns}$	400	μA	1, 2
			$t_{\text{RAS}} \leq 1 \mu\text{s}$	500	μA	1, 2
CAS before RAS self refresh current (only for the μPD42S16165L)	I _{CC7}	$\overline{\text{RAS}}, \overline{\text{CAS}}$: $t_{\text{RASS}} = 5 \text{ ms}$ $V_{\text{CC}} - 0.2 \text{ V} \leq V_{\text{IH}} \leq V_{\text{IH}}(\text{MAX})$ $0 \text{ V} \leq V_{\text{IL}} \leq 0.2 \text{ V}$ $I_{\text{O}} = 0 \text{ mA}$		200	μA	2
Input leakage current	I _{I(L)}	$V_{\text{I}} = 0 \text{ to } 3.6 \text{ V}$ All other pins not under test = 0 V	-5	+5	μA	
Output leakage current	I _{O(L)}	$V_{\text{O}} = 0 \text{ to } 3.6 \text{ V}$ Output is disabled (Hi-Z)	-5	+5	μA	
High level output voltage	V _{OH}	$I_{\text{O}} = -2.0 \text{ mA}$	2.4		V	
Low level output voltage	V _{OL}	$I_{\text{O}} = +2.0 \text{ mA}$		0.4	V	

- Notes**
1. I_{CC1}, I_{CC3}, I_{CC4}, I_{CC5} and I_{CC6} depend on cycle rates (t_{RC} and t_{HPC}).
 2. Specified values are obtained with outputs unloaded.
 3. I_{CC1} and I_{CC3} are measured assuming that address can be changed once or less during $\overline{\text{RAS}} \leq V_{\text{IL}}(\text{MAX})$ and $\overline{\text{CAS}} \geq V_{\text{IH}}(\text{MIN})$.
 4. I_{CC3} is measured assuming that all column address inputs are held at either high or low.
 5. I_{CC4} is measured assuming that all column address inputs are switched only once during each hyper page (EDO) cycle.

★ AC Characteristics (Recommended Operating Conditions unless otherwise noted)

AC Characteristics Test Conditions

(1) Input timing specification

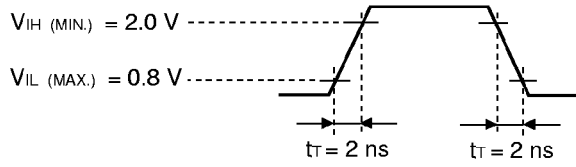

(2) Output timing specification

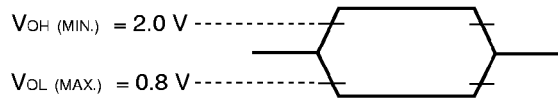

(3) Output load condition

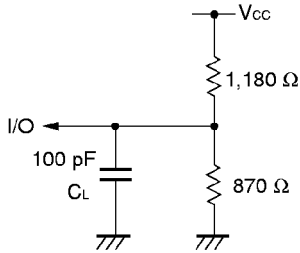

Common to Read, Write, Read Modify Write Cycle

Parameter	Symbol	t _{RAC} = 50 ns		t _{RAC} = 60 ns		t _{RAC} = 70 ns		Unit	Notes	
		MIN.	MAX.	MIN.	MAX.	MIN.	MAX.			
Read / Write cycle time	t _{RC}	84	–	104	–	124	–	ns		
$\overline{\text{RAS}}$ precharge time	t _{RP}	30	–	40	–	50	–	ns		
$\overline{\text{CAS}}$ precharge time	t _{CPN}	8	–	10	–	10	–	ns		
$\overline{\text{RAS}}$ pulse width	t _{RAS}	50	10,000	60	10,000	70	10,000	ns	1	
$\overline{\text{CAS}}$ pulse width	t _{CAS}	8	10,000	10	10,000	12	10,000	ns		
$\overline{\text{RAS}}$ hold time	t _{RSH}	10	–	10	–	12	–	ns		
$\overline{\text{CAS}}$ hold time	t _{CSH}	38	–	40	–	50	–	ns		
$\overline{\text{RAS}}$ to $\overline{\text{CAS}}$ delay time	t _{RCD}	11	37	14	45	14	52	ns	2	
$\overline{\text{RAS}}$ to column address delay time	t _{RAD}	9	25	12	30	12	35	ns	2	
$\overline{\text{CAS}}$ to $\overline{\text{RAS}}$ precharge time	t _{CRP}	5	–	5	–	5	–	ns	3	
Row address setup time	t _{ASR}	0	–	0	–	0	–	ns		
Row address hold time	t _{RAH}	7	–	10	–	10	–	ns		
Column address setup time	t _{ASC}	0	–	0	–	0	–	ns		
Column address hold time	t _{CAH}	7	–	10	–	12	–	ns		
$\overline{\text{OE}}$ lead time referenced to $\overline{\text{RAS}}$	t _{OES}	0	–	0	–	0	–	ns		
$\overline{\text{CAS}}$ to data setup time	t _{CLZ}	0	–	0	–	0	–	ns		
$\overline{\text{OE}}$ to data setup time	t _{OLZ}	0	–	0	–	0	–	ns		
$\overline{\text{OE}}$ to data delay time	t _{OED}	10	–	13	–	15	–	ns		
Masked byte write hold time referenced to $\overline{\text{RAS}}$	t _{MRH}	0	–	0	–	0	–	ns		
Transition time (rise and fall)	t _T	1	50	1	50	1	50	ns		
Refresh time	μPD42S16165L	t _{REF}	–	128	–	128	–	128	ms	4
	μPD4216165L	t _{REF}	–	64	–	64	–	64	ms	

- Notes 1.** In $\overline{\text{CAS}}$ before $\overline{\text{RAS}}$ refresh cycles, $t_{\text{RAS}(\text{MAX.})}$ is 100 μs.
 If $10 \mu\text{s} < t_{\text{RAS}} < 100 \mu\text{s}$, $\overline{\text{RAS}}$ precharge time for $\overline{\text{CAS}}$ before $\overline{\text{RAS}}$ self refresh (t_{RPS}) is applied.
- 2.** For read cycles, access time is defined as follows:

Input conditions	Access time	Access time from $\overline{\text{RAS}}$
$t_{\text{RAD}} \leq t_{\text{RAD}(\text{MAX.})}$ and $t_{\text{RCD}} \leq t_{\text{RCD}(\text{MAX.})}$	$t_{\text{RAC}(\text{MAX.})}$	$t_{\text{RAC}(\text{MAX.})}$
$t_{\text{RAD}} > t_{\text{RAD}(\text{MAX.})}$ and $t_{\text{RCD}} \leq t_{\text{RCD}(\text{MAX.})}$	$t_{\text{AA}(\text{MAX.})}$	$t_{\text{RAD}} + t_{\text{AA}(\text{MAX.})}$
$t_{\text{RCD}} > t_{\text{RCD}(\text{MAX.})}$	$t_{\text{CAC}(\text{MAX.})}$	$t_{\text{RCD}} + t_{\text{CAC}(\text{MAX.})}$

$t_{\text{RAD}(\text{MAX.})}$ and $t_{\text{RCD}(\text{MAX.})}$ are specified as reference points only; they are not restrictive operating parameters. They are used to determine which access time (t_{RAC} , t_{AA} or t_{CAC}) is to be used for finding out when output data will be available. Therefore, the input conditions $t_{\text{RAD}} \geq t_{\text{RAD}(\text{MAX.})}$ and $t_{\text{RCD}} \geq t_{\text{RCD}(\text{MAX.})}$ will not cause any operation problems.

- 3.** $t_{\text{CRP}(\text{MIN.})}$ requirement is applied to $\overline{\text{RAS}}$, $\overline{\text{CAS}}$ cycles.
- 4.** This specification is applied only to the μPD42S16165L.

Read Cycle

Parameter	Symbol	$t_{\text{RAC}} = 50 \text{ ns}$		$t_{\text{RAC}} = 60 \text{ ns}$		$t_{\text{RAC}} = 70 \text{ ns}$		Unit	Notes
		MIN.	MAX.	MIN.	MAX.	MIN.	MAX.		
Access time from $\overline{\text{RAS}}$	t_{RAC}	–	50	–	60	–	70	ns	1
Access time from $\overline{\text{CAS}}$	t_{CAC}	–	15	–	17	–	18	ns	1
Access time from column address	t_{AA}	–	25	–	30	–	35	ns	1
Access time from $\overline{\text{OE}}$	t_{OEA}	–	13	–	15	–	18	ns	
Column address lead time referenced to $\overline{\text{RAS}}$	t_{RAL}	25	–	30	–	35	–	ns	
Read command setup time	t_{RCS}	0	–	0	–	0	–	ns	
Read command hold time referenced to $\overline{\text{RAS}}$	t_{RRH}	0	–	0	–	0	–	ns	2
Read command hold time referenced to $\overline{\text{CAS}}$	t_{RCH}	0	–	0	–	0	–	ns	2
Output buffer turn-off delay time from $\overline{\text{OE}}$	t_{OEZ}	0	10	0	13	0	15	ns	3
$\overline{\text{CAS}}$ hold time to $\overline{\text{OE}}$	t_{CHO}	5	–	5	–	5	–	ns	4

- Notes 1.** For read cycles, access time is defined as follows:

Input conditions	Access time	Access time from $\overline{\text{RAS}}$
$t_{\text{RAD}} \leq t_{\text{RAD}(\text{MAX.})}$ and $t_{\text{RCD}} \leq t_{\text{RCD}(\text{MAX.})}$	$t_{\text{RAC}(\text{MAX.})}$	$t_{\text{RAC}(\text{MAX.})}$
$t_{\text{RAD}} > t_{\text{RAD}(\text{MAX.})}$ and $t_{\text{RCD}} \leq t_{\text{RCD}(\text{MAX.})}$	$t_{\text{AA}(\text{MAX.})}$	$t_{\text{RAD}} + t_{\text{AA}(\text{MAX.})}$
$t_{\text{RCD}} > t_{\text{RCD}(\text{MAX.})}$	$t_{\text{CAC}(\text{MAX.})}$	$t_{\text{RCD}} + t_{\text{CAC}(\text{MAX.})}$

$t_{\text{RAD}(\text{MAX.})}$ and $t_{\text{RCD}(\text{MAX.})}$ are specified as reference points only; they are not restrictive operating parameters. They are used to determine which access time (t_{RAC} , t_{AA} or t_{CAC}) is to be used for finding out when output data will be available. Therefore, the input conditions $t_{\text{RAD}} \geq t_{\text{RAD}(\text{MAX.})}$ and $t_{\text{RCD}} \geq t_{\text{RCD}(\text{MAX.})}$ will not cause any operation problems.

- 2.** Either $t_{\text{RCH}(\text{MIN.})}$ or $t_{\text{RRH}(\text{MIN.})}$ should be met in read cycles.
- 3.** $t_{\text{OEZ}(\text{MAX.})}$ defines the time when the output achieves the condition of Hi-Z and is not referenced to V_{OH} or V_{OL} .
- 4.** $\overline{\text{WE}}$: inactive (in read cycle)
 $\overline{\text{CAS}}$: inactive, $\overline{\text{OE}}$: active t_{CHO} is effective.
 CAS , $\overline{\text{OE}}$: active t_{OCH} is effective.

Write Cycle

Parameter	Symbol	t _{RAC} = 50 ns		t _{RAC} = 60 ns		t _{RAC} = 70 ns		Unit	Notes
		MIN.	MAX.	MIN.	MAX.	MIN.	MAX.		
\overline{WE} hold time referenced to \overline{CAS}	t _{WCH}	7	–	10	–	10	–	ns	1
\overline{WE} pulse width	t _{WP}	8	–	10	–	10	–	ns	1
\overline{WE} lead time referenced to \overline{RAS}	t _{RWL}	10	–	10	–	12	–	ns	
\overline{WE} lead time referenced to \overline{CAS}	t _{cWL}	8	–	10	–	12	–	ns	
\overline{WE} setup time	t _{WCS}	0	–	0	–	0	–	ns	2
\overline{OE} hold time	t _{OEH}	0	–	0	–	0	–	ns	
Data-in setup time	t _{DS}	0	–	0	–	0	–	ns	3
Data-in hold time	t _{DH}	7	–	10	–	10	–	ns	3

- Notes**
1. t_{WP (MIN.)} is applied to late write cycles or read modify write cycles. In early write cycles, t_{WCH (MIN.)} should be met.
 2. If t_{WCS} ≥ t_{WCS (MIN.)}, the cycle is an early write cycle and the data out will remain Hi-Z through the entire cycle.
 3. t_{DS (MIN.)} and t_{DH (MIN.)} are referenced to the \overline{CAS} falling edge in early write cycles. In late write cycles and read modify write cycles, they are referenced to the \overline{WE} falling edge.

Read Modify Write Cycle

Parameter	Symbol	t _{RAC} = 50 ns		t _{RAC} = 60 ns		t _{RAC} = 70 ns		Unit	Notes
		MIN.	MAX.	MIN.	MAX.	MIN.	MAX.		
Read modify write cycle time	t _{RWC}	107	–	133	–	157	–	ns	
\overline{RAS} to \overline{WE} delay time	t _{RWD}	64	–	77	–	89	–	ns	1
\overline{CAS} to \overline{WE} delay time	t _{cWD}	27	–	32	–	37	–	ns	1
Column address to \overline{WE} delay time	t _{AWD}	39	–	47	–	54	–	ns	1

- Note**
1. If t_{WCS} ≥ t_{WCS (MIN.)}, the cycle is an early write cycle and the data out will remain Hi-Z through the entire cycle. If t_{RWD} ≥ t_{RWD (MIN.)}, t_{cWD} ≥ t_{cWD (MIN.)}, t_{AWD} ≥ t_{AWD (MIN.)} and t_{CPWD} ≥ t_{CPWD (MIN.)}, the cycle is a read modify write cycle and the data out will contain data read from the selected cell. If neither of the above conditions is met, the state of the data out is indeterminate.

Hyper Page Mode (EDO)

Parameter	Symbol	t _{RAC} = 50 ns		t _{RAC} = 60 ns		t _{RAC} = 70 ns		Unit	Notes
		MIN.	MAX.	MIN.	MAX.	MIN.	MAX.		
Read / Write cycle time	t _{HPC}	20	–	25	–	30	–	ns	1
$\overline{\text{RAS}}$ pulse width	t _{RASP}	50	125,000	60	125,000	70	125,000	ns	
$\overline{\text{CAS}}$ pulse width	t _{HCAS}	8	10,000	10	10,000	12	10,000	ns	
$\overline{\text{CAS}}$ precharge time	t _{CP}	8	–	10	–	10	–	ns	
Access time from $\overline{\text{CAS}}$ precharge	t _{ACP}	–	30	–	35	–	40	ns	
$\overline{\text{CAS}}$ precharge to $\overline{\text{WE}}$ delay time	t _{CPWD}	41	–	52	–	59	–	ns	2
$\overline{\text{RAS}}$ hold time from $\overline{\text{CAS}}$ precharge	t _{RHCP}	30	–	35	–	40	–	ns	
Read modify write cycle time	t _{HPRWC}	52	–	66	–	75	–	ns	
Data output hold time	t _{DHC}	5	–	5	–	5	–	ns	
$\overline{\text{OE}}$ to $\overline{\text{CAS}}$ hold time	t _{COH}	5	–	5	–	5	–	ns	3
$\overline{\text{OE}}$ precharge time	t _{OEP}	5	–	5	–	5	–	ns	
Output buffer turn-off delay from $\overline{\text{WE}}$	t _{WEZ}	0	10	0	13	0	15	ns	4,5
$\overline{\text{WE}}$ pulse width	t _{WPZ}	7	–	10	–	10	–	ns	5
Output buffer turn-off delay from $\overline{\text{RAS}}$	t _{OFR}	0	10	0	13	0	15	ns	4,5
Output buffer turn-off delay from $\overline{\text{CAS}}$	t _{OFC}	0	10	0	13	0	15	ns	4,5

Notes 1. t_{HPC} (MIN.) is applied to $\overline{\text{CAS}}$ access.

2. If t_{WCS} ≥ t_{WCS} (MIN.), the cycle is an early write cycle and the data out will remain Hi-Z through the entire cycle. If t_{RWD} ≥ t_{RWD} (MIN.), t_{CWD} ≥ t_{CWD} (MIN.), t_{AWD} ≥ t_{AWD} (MIN.) and t_{CPWD} ≥ t_{CPWD} (MIN.), the cycle is a read modify write cycle and the data out will contain data read from the selected cell. If neither of the above conditions is met, the state of the data out is indeterminate.
 3. $\overline{\text{WE}}$: inactive (in read cycle)
 $\overline{\text{CAS}}$: inactive, $\overline{\text{OE}}$: active t_{CHO} is effective.
 $\overline{\text{CAS}}$, $\overline{\text{OE}}$: active t_{COH} is effective.
 4. t_{OFC} (MAX.), t_{OFR} (MAX.) and t_{WEZ} (MAX.) define the time when the output achieves the conditions of Hi-Z and is not referenced to V_{OH} or V_{OL}.
 5. To make I/Os to Hi-Z in read cycle, it is necessary to control $\overline{\text{RAS}}$, $\overline{\text{CAS}}$, $\overline{\text{WE}}$, $\overline{\text{OE}}$ as follows. The effective specification depends on state of each signal.
 - (1) Both $\overline{\text{RAS}}$ and $\overline{\text{CAS}}$ are inactive (at the end of the read cycle)
 $\overline{\text{WE}}$: inactive, $\overline{\text{OE}}$: active
 t_{OFC} is effective when $\overline{\text{RAS}}$ is inactivated before $\overline{\text{CAS}}$ is inactivated.
 t_{OFR} is effective when $\overline{\text{CAS}}$ is inactivated before $\overline{\text{RAS}}$ is inactivated.
 The slower of t_{OFC} and t_{OFR} becomes effective.
 - (2) Both $\overline{\text{RAS}}$ and $\overline{\text{CAS}}$ are active or either $\overline{\text{RAS}}$ or $\overline{\text{CAS}}$ is active (in read cycle)
 $\overline{\text{WE}}$, $\overline{\text{OE}}$: inactive t_{OEZ} is effective.
 Both $\overline{\text{RAS}}$ and $\overline{\text{CAS}}$ are inactive or $\overline{\text{RAS}}$ is active and $\overline{\text{CAS}}$ is inactive (at the end of read cycle)
 $\overline{\text{WE}}$, $\overline{\text{OE}}$: active and either t_{RRH} or t_{TRCH} must be met t_{WEZ} and t_{WPZ} are effective.
 The faster of t_{OEZ} and t_{WEZ} becomes effective.
- The faster of (1) and (2) becomes effective.

Refresh Cycle

Parameter	Symbol	t _{RAC} = 50 ns		t _{RAC} = 60 ns		t _{RAC} = 70 ns		Unit	Notes
		MIN.	MAX.	MIN.	MAX.	MIN.	MAX.		
$\overline{\text{CAS}}$ setup time	t _{CSR}	5	–	5	–	5	–	ns	
$\overline{\text{CAS}}$ hold time ($\overline{\text{CAS}}$ before $\overline{\text{RAS}}$ refresh)	t _{CHR}	10	–	10	–	10	–	ns	
$\overline{\text{RAS}}$ precharge $\overline{\text{CAS}}$ hold time	t _{RPC}	5	–	5	–	5	–	ns	
$\overline{\text{RAS}}$ pulse width ($\overline{\text{CAS}}$ before $\overline{\text{RAS}}$ self refresh)	t _{RASS}	100	–	100	–	100	–	μs	1
$\overline{\text{RAS}}$ precharge time ($\overline{\text{CAS}}$ before $\overline{\text{RAS}}$ self refresh)	t _{RPS}	90	–	110	–	130	–	ns	1
$\overline{\text{CAS}}$ hold time ($\overline{\text{CAS}}$ before $\overline{\text{RAS}}$ self refresh)	t _{CHS}	–50	–	–50	–	–50	–	ns	1
$\overline{\text{WE}}$ hold time	t _{WHR}	15	–	15	–	15	–	ns	

Note 1. This specification is applied only to the μPD42S16165L.

Read Cycle

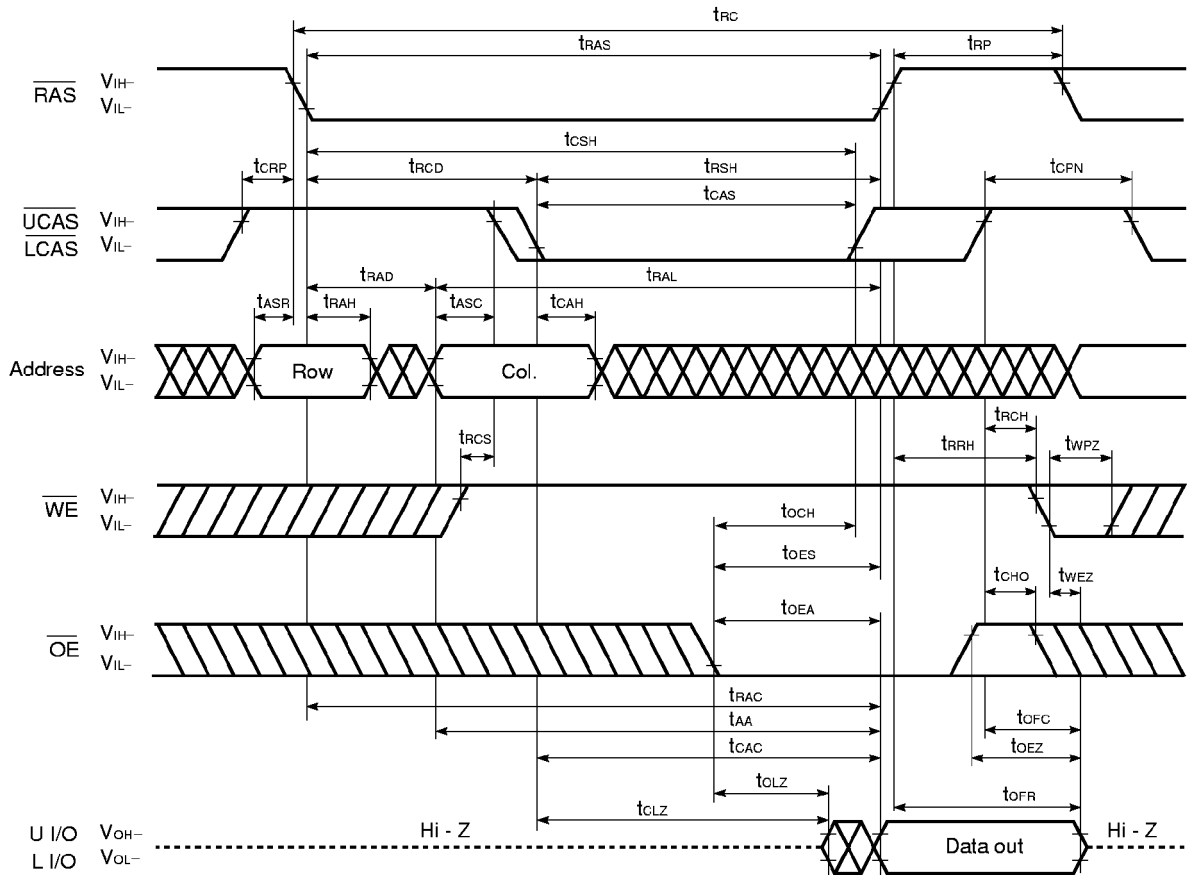

Upper Byte Read Cycle

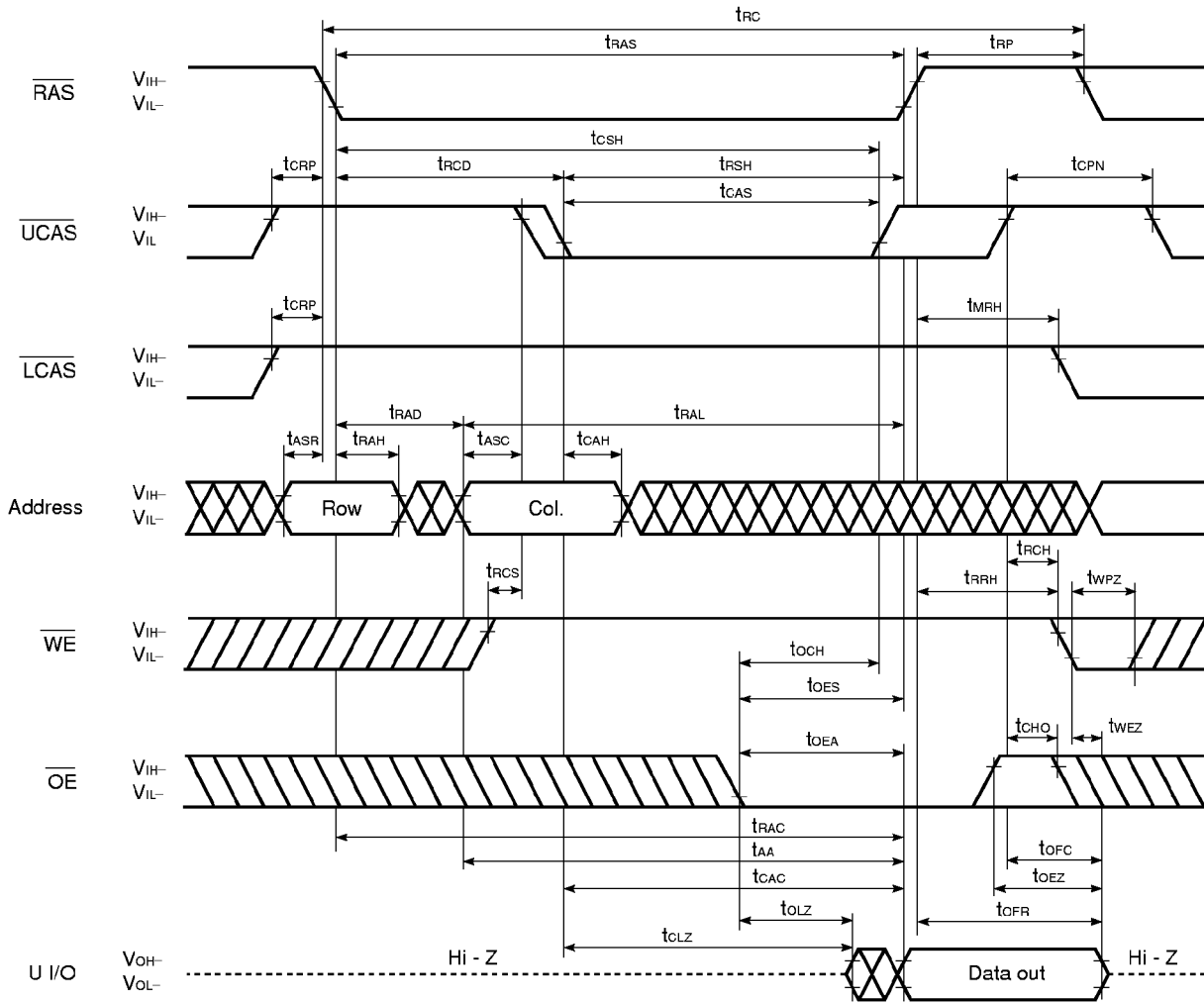

Remark L I/O: Hi-Z

Lower Byte Read Cycle

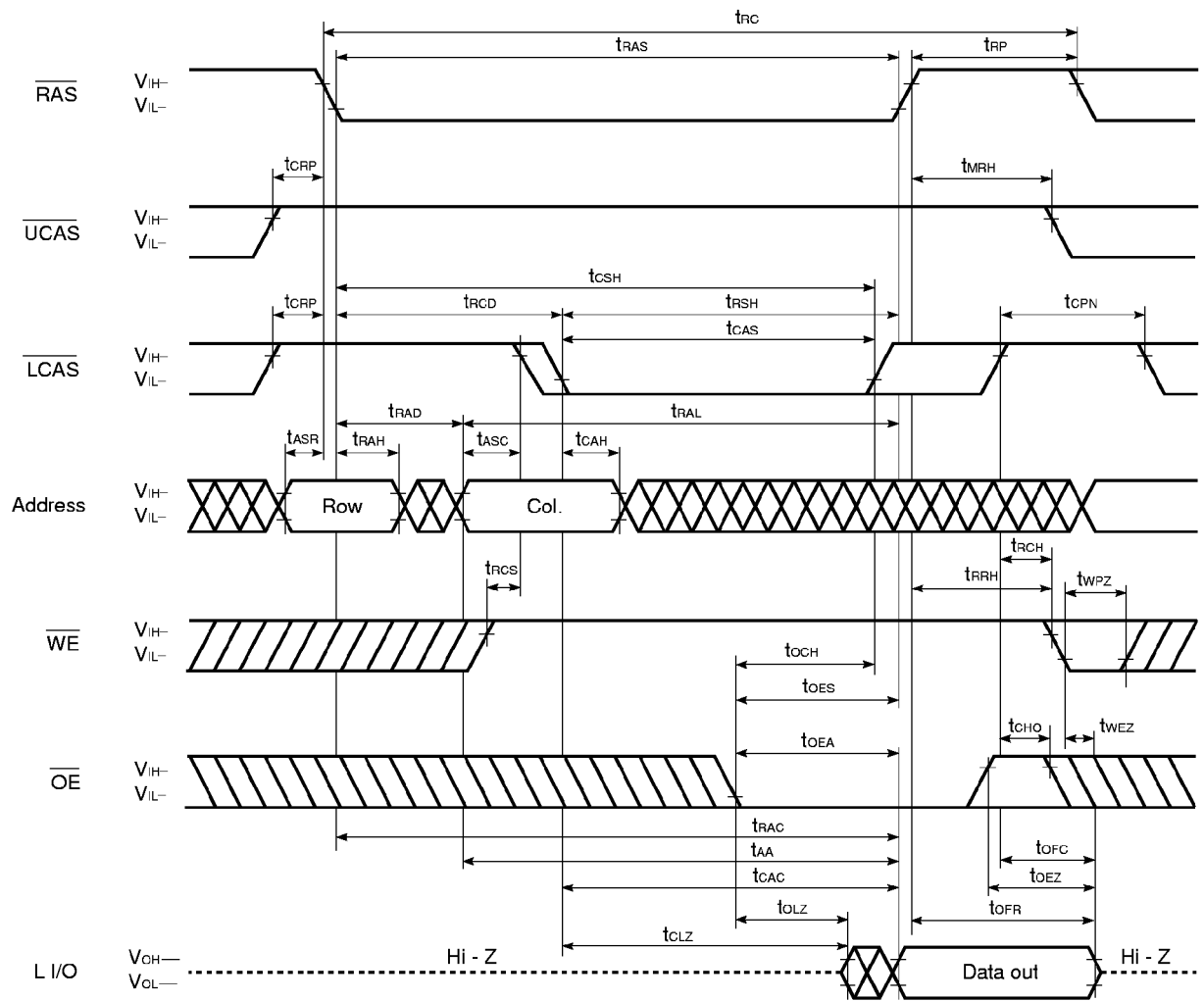

Remark U I/O: Hi-Z

Early Write Cycle

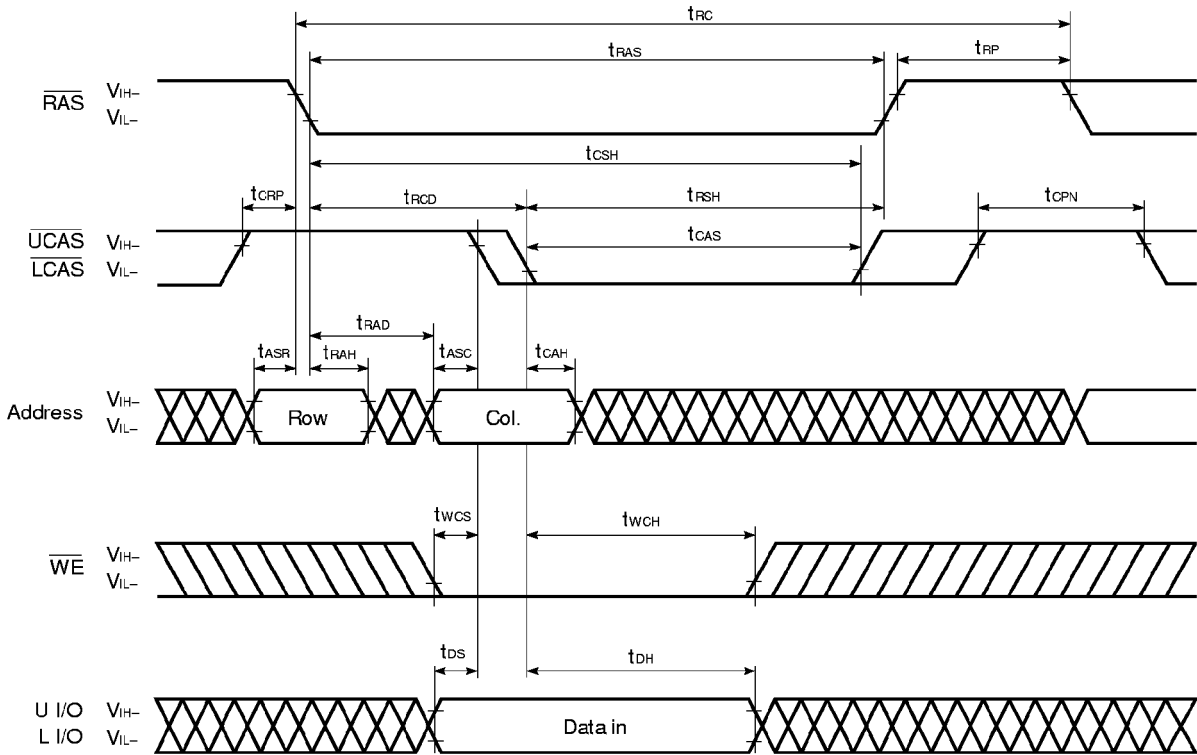

Remark \overline{OE} : Don't care

Upper Byte Early Write Cycle

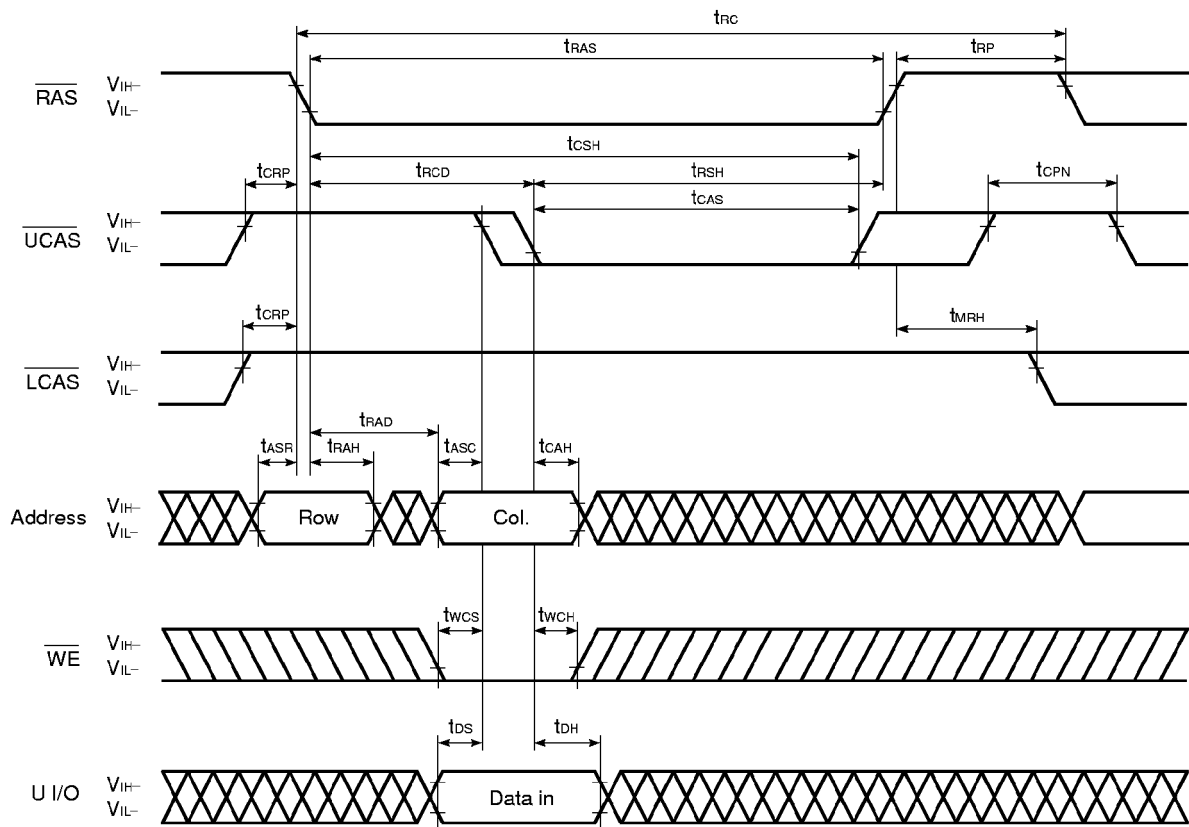

Remark \overline{OE} , L I/O: Don't care

Lower Byte Early Write Cycle

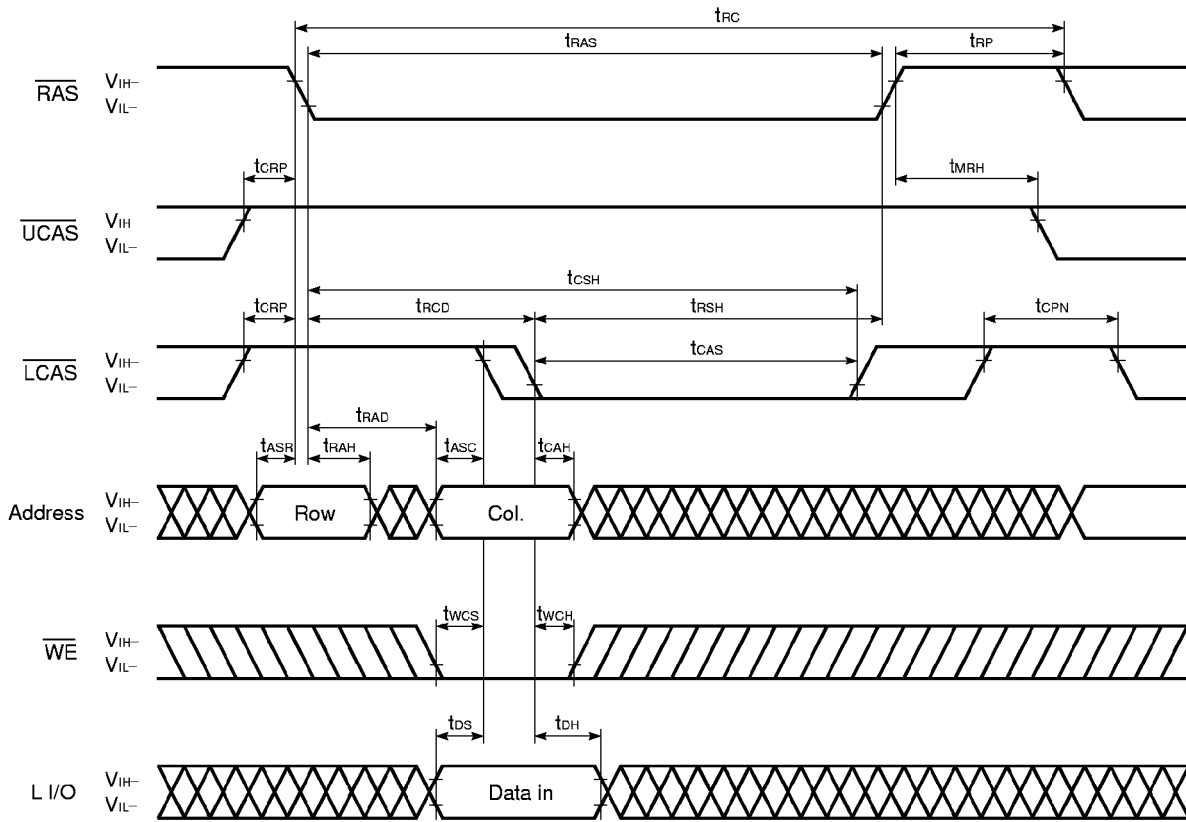

Remark \overline{OE} , U I/O: Don't care

Late Write Cycle

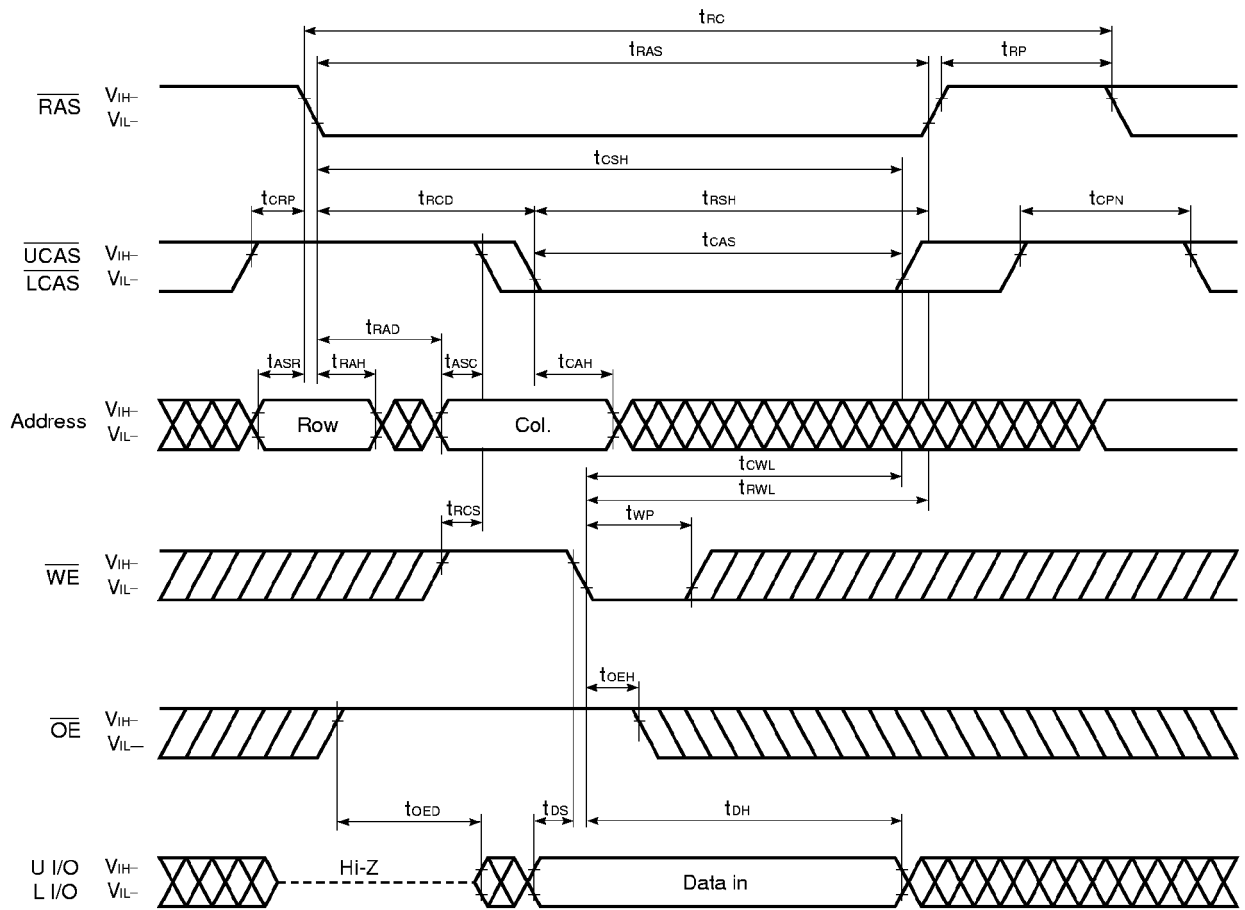

Upper Byte Late Write Cycle

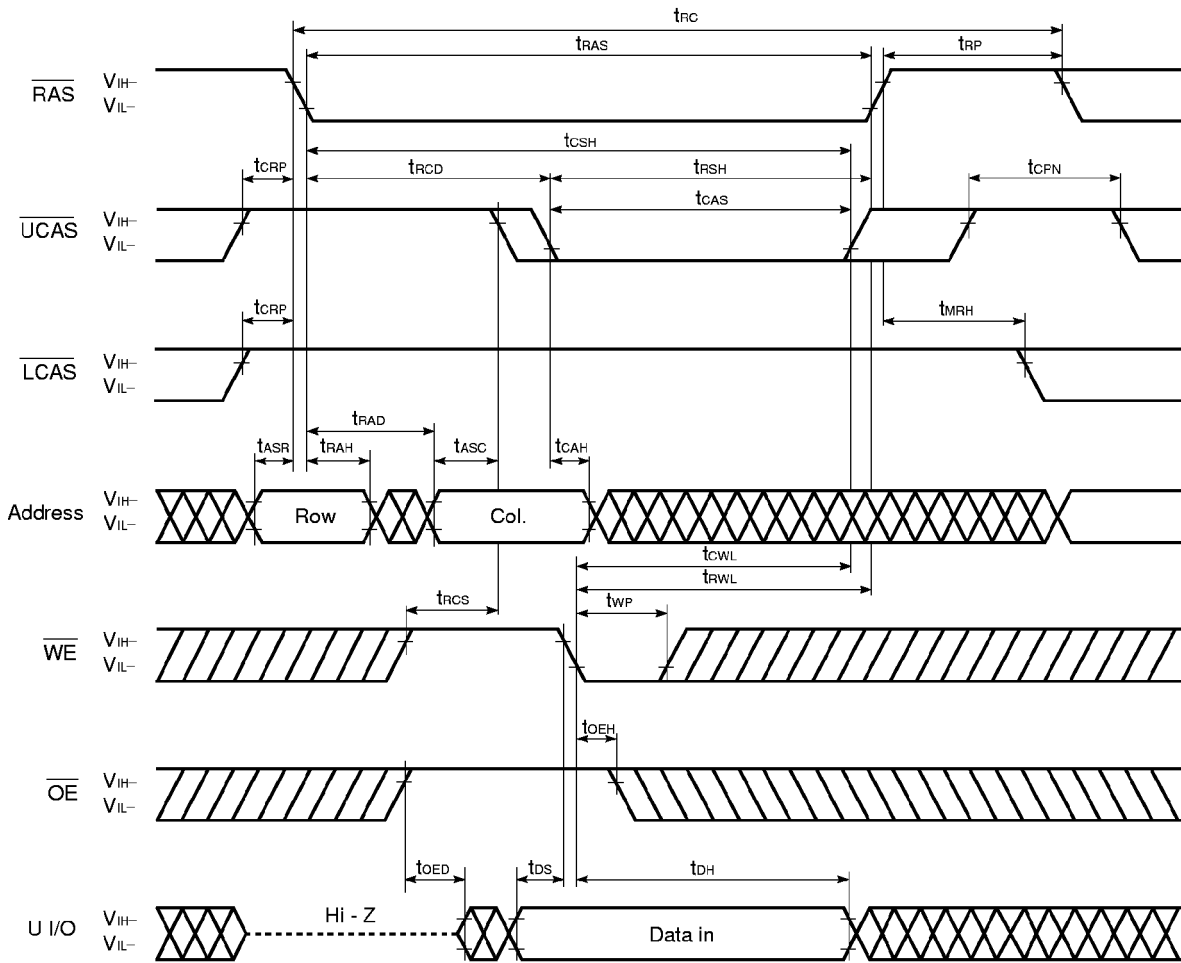

Remark L I/O: Don't care

Lower Byte Late Write Cycle

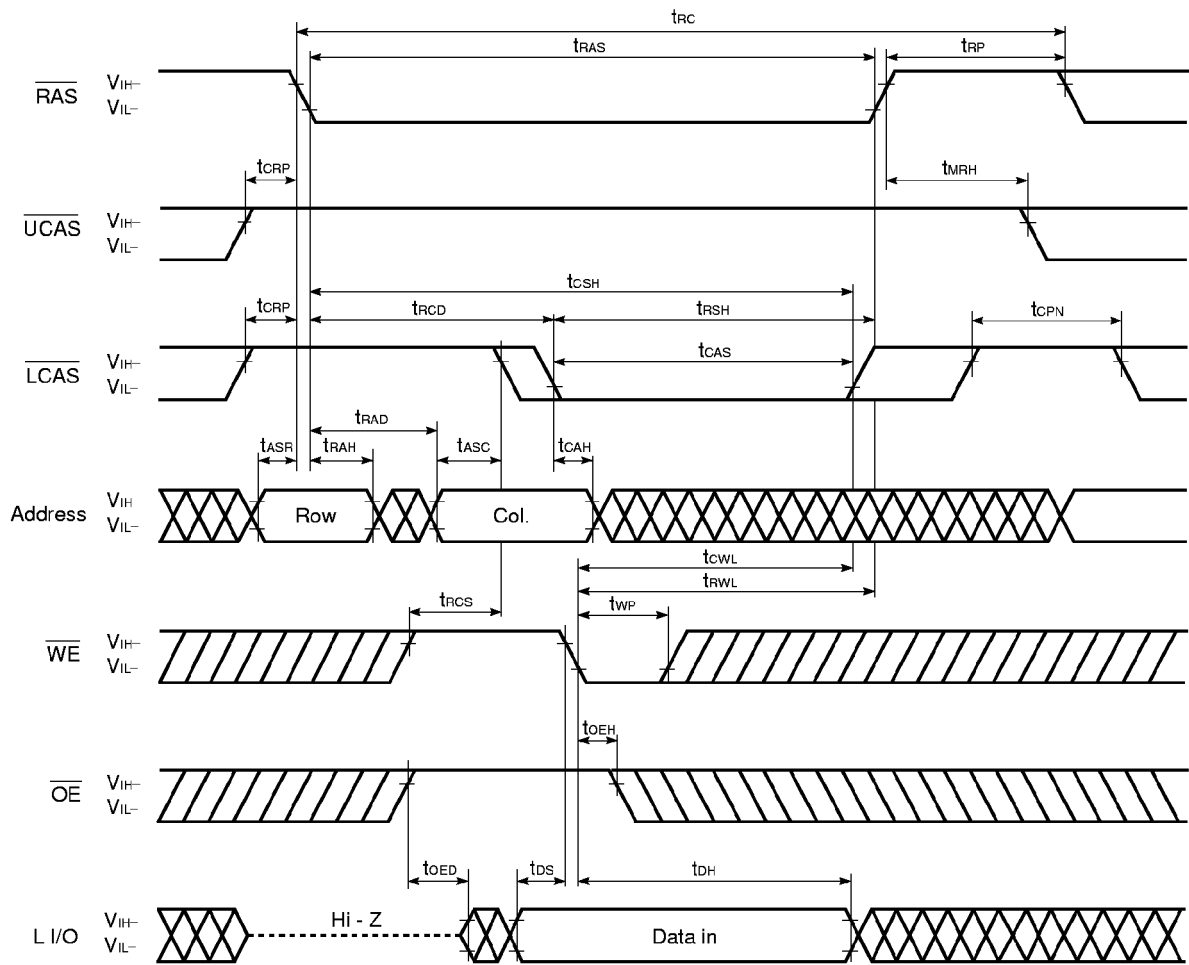

Remark U I/O: Don't care

Read Modify Write Cycle

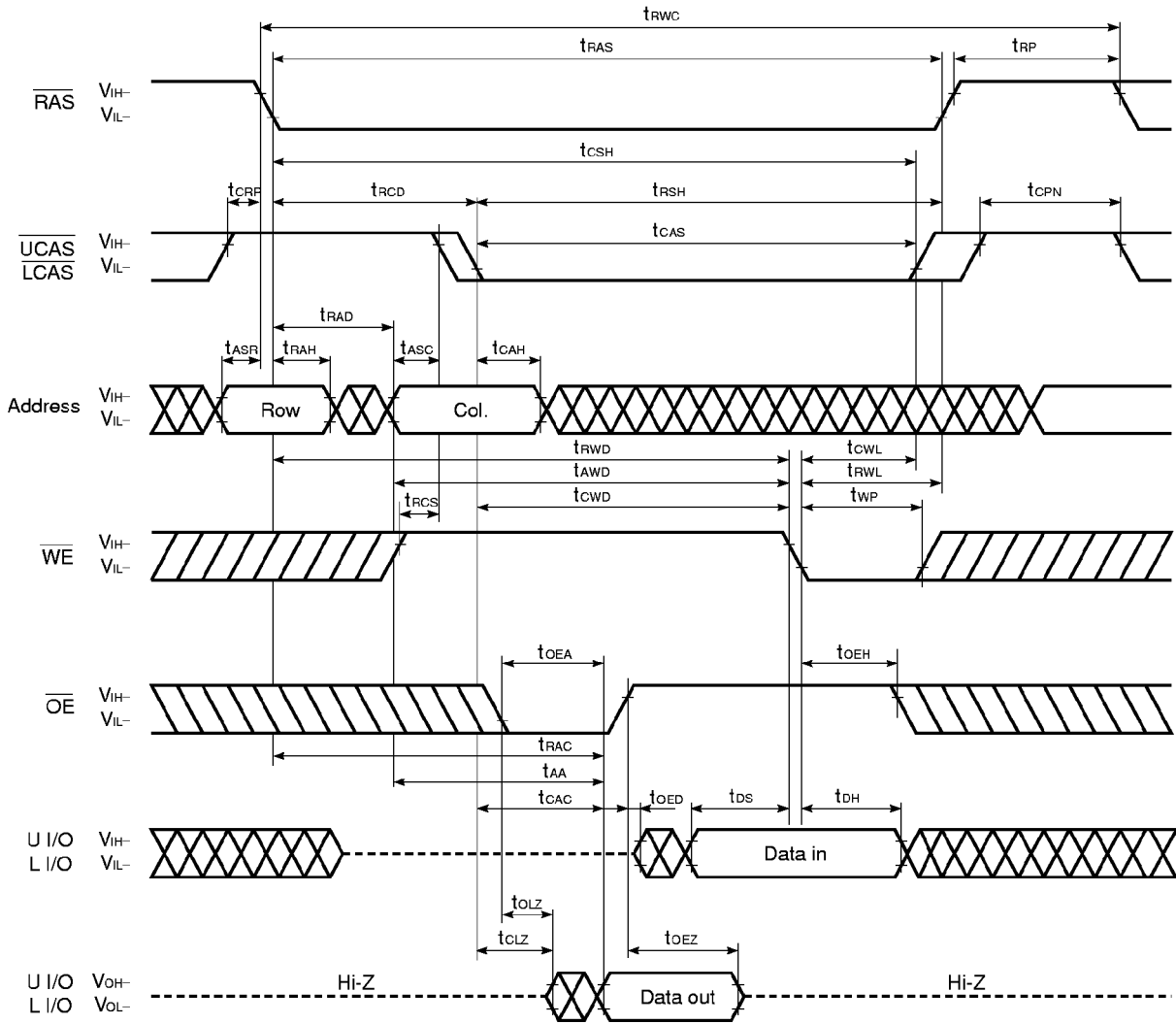

Upper Byte Read Modify Write Cycle

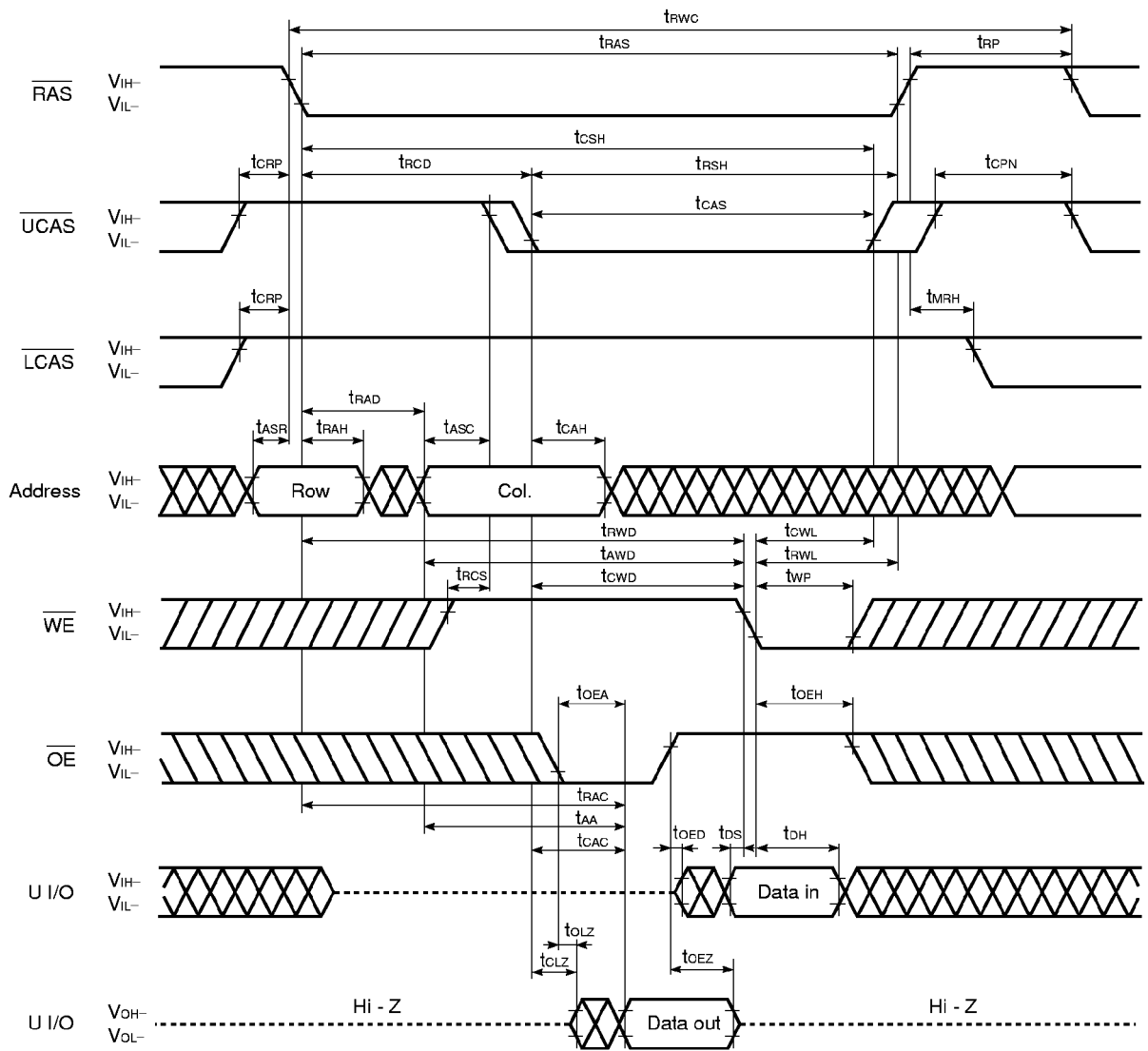

Remark In this cycle, the input data to Lower I/O is ineffective. The data out of that remains Hi-Z.

Lower Byte Read Modify Write Cycle

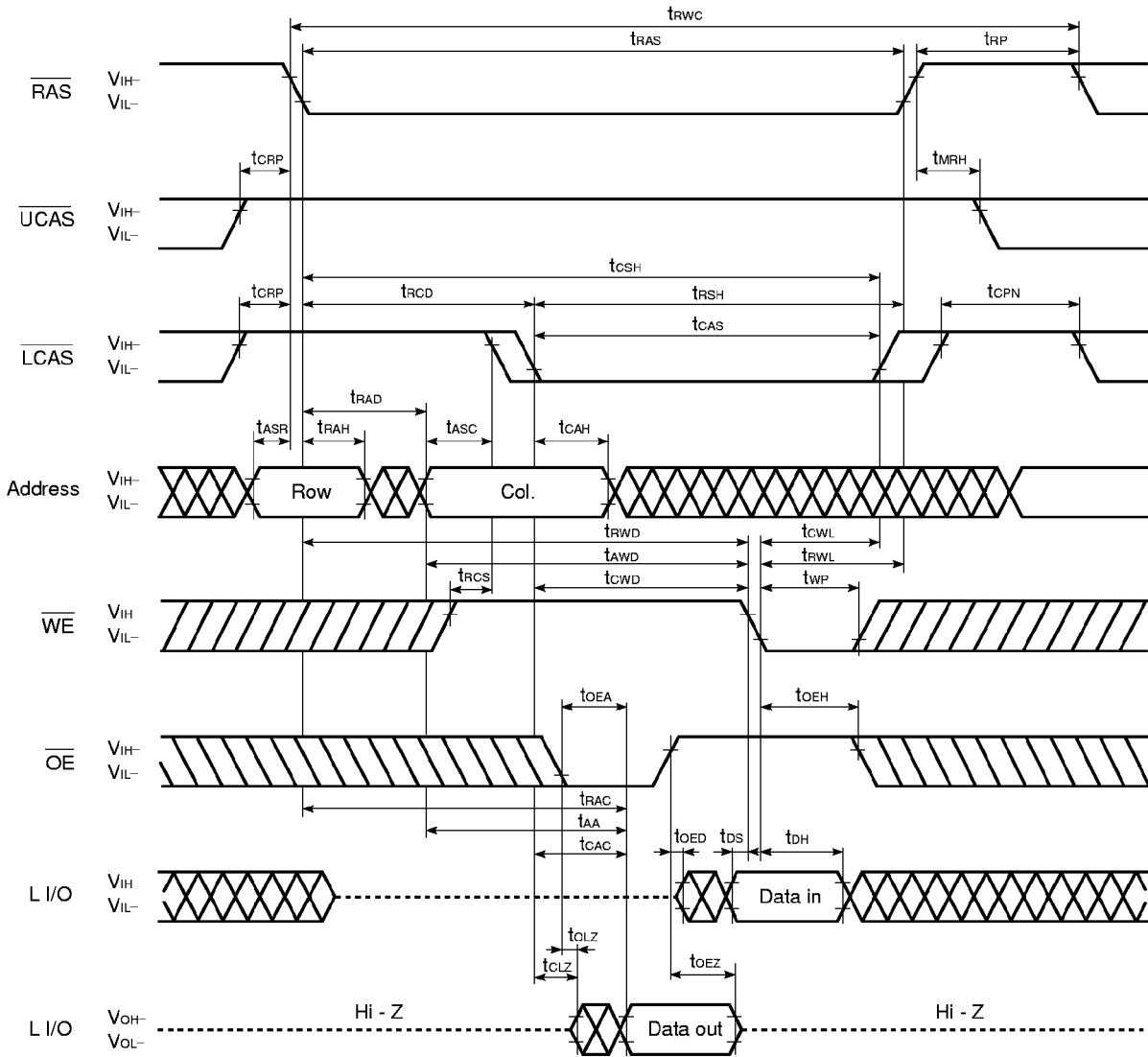

Remark In this cycle, the input data to Upper I/O is ineffective. The data out of that remains Hi-Z.

Hyper Page Mode (EDO) Read Cycle

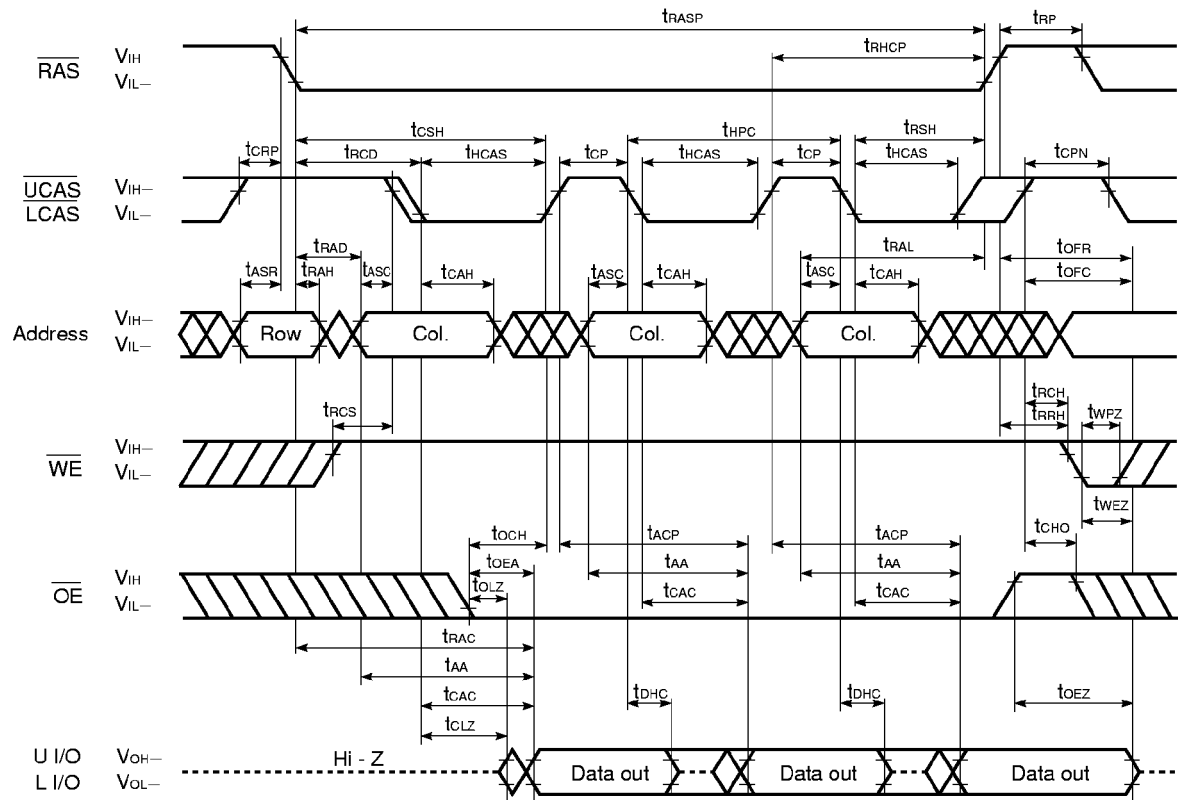

Remark In the hyper page mode (EDO), read, write and read modify write cycles are available for each of the consecutive \overline{CAS} cycles within the same \overline{RAS} cycle.

Hyper Page Mode (EDO) Read Cycle (\overline{OE} Control)

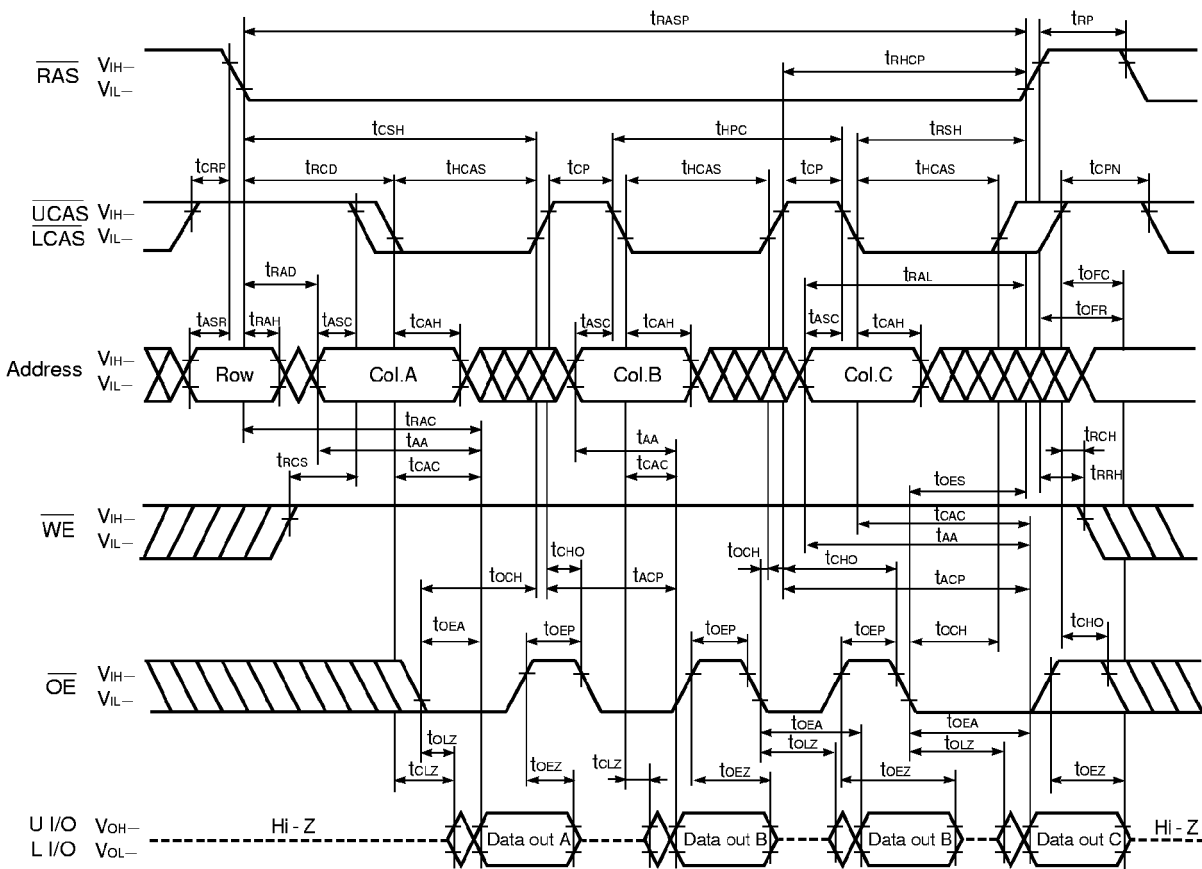

Remark In the hyper page mode (EDO), read, write and read modify write cycles are available for each of the consecutive CAS cycles within the same RAS cycle.

Hyper Page Mode (EDO) Early Write Cycle

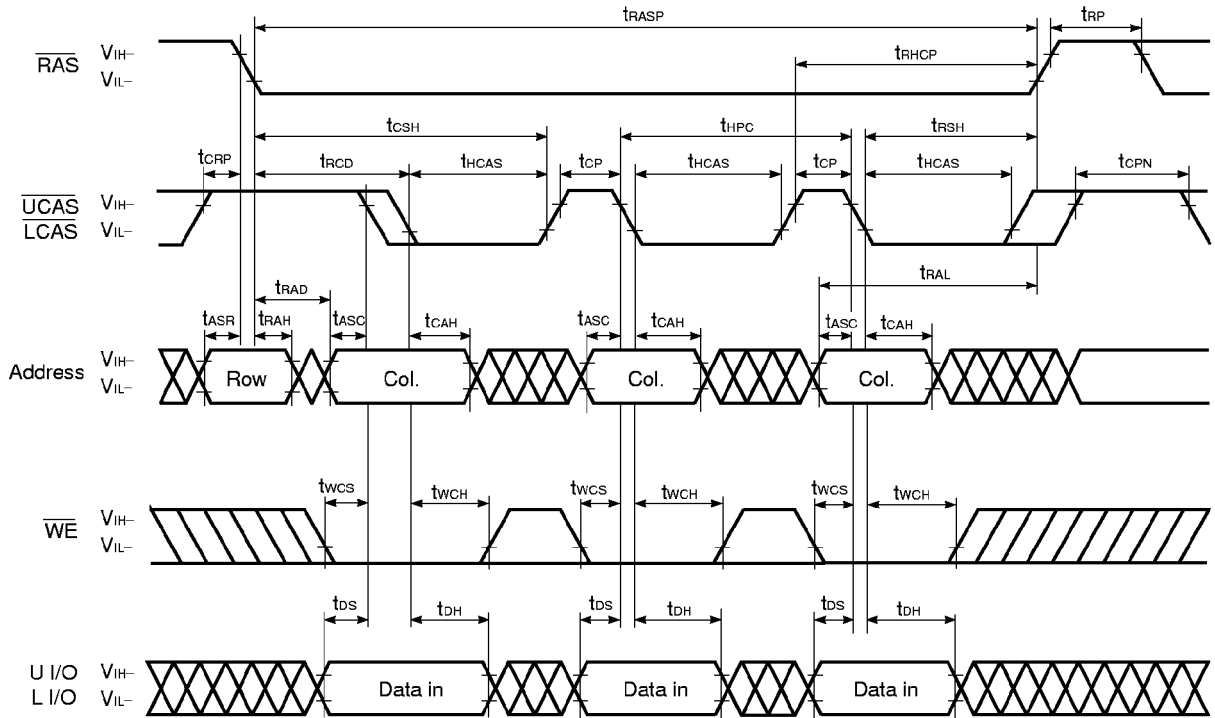

- Remarks**
1. \overline{OE} : Don't care
 2. In the hyper page mode (EDO), read, write and read modify write cycles are available for each of the consecutive CAS cycles within the same RAS cycle.

Hyper Page Mode (EDO) Byte Early Write Cycle

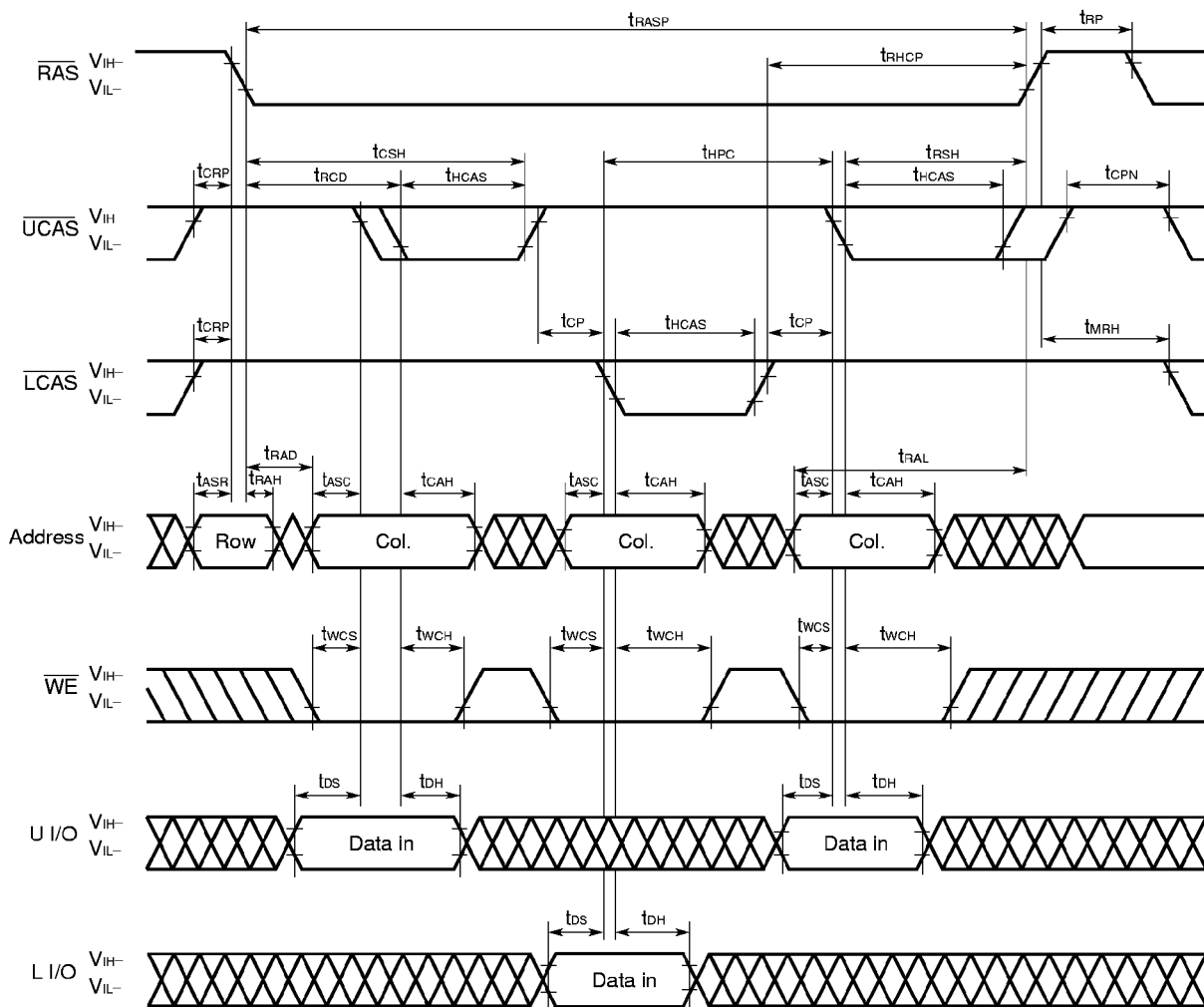

- Remarks**
1. \overline{OE} : Don't care
 2. In the hyper page mode (EDO), read, write and read modify write cycles are available for each of the consecutive \overline{CAS} cycles within the same \overline{RAS} cycle.
 3. This cycle can be used to control either \overline{UCAS} or \overline{LCAS} only. Or, it can be used to control \overline{UCAS} or \overline{LCAS} simultaneously, or at random.

Hyper Page Mode (EDO) Late Write Cycle

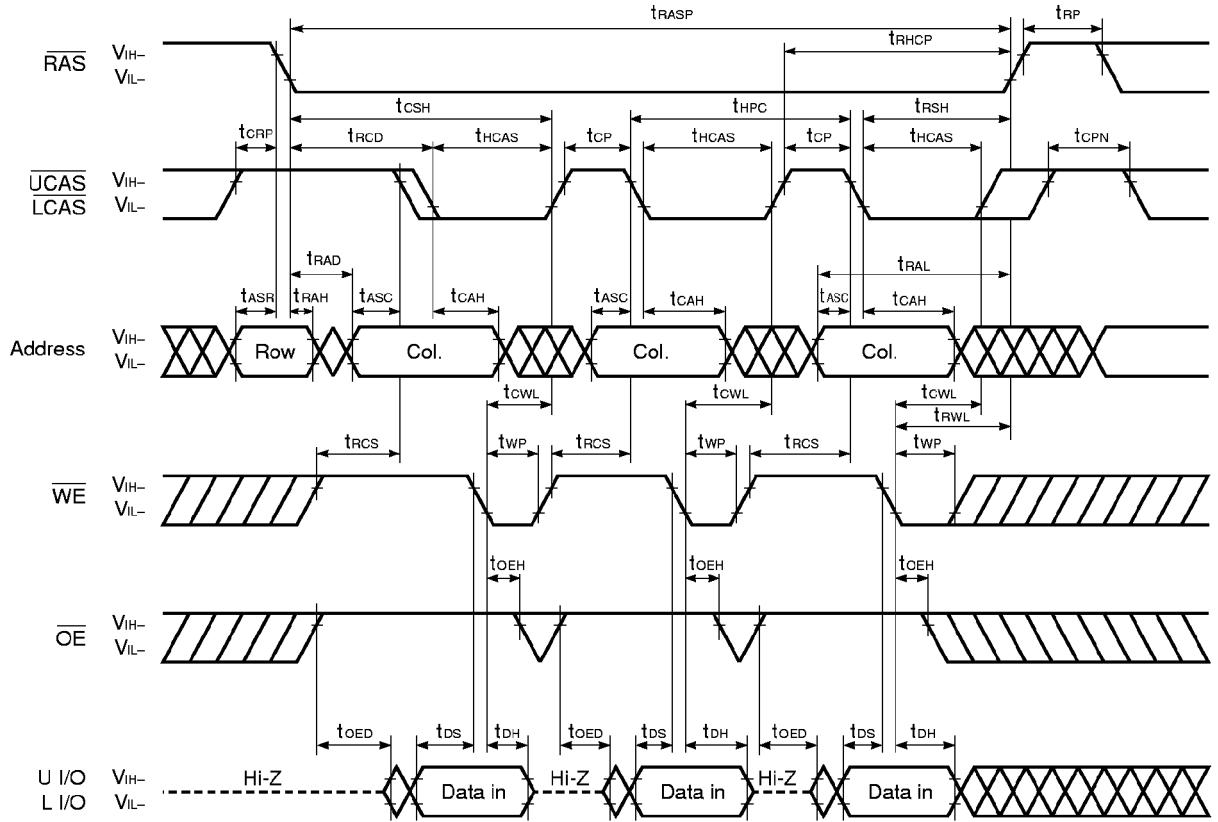

Remark In the hyper page mode (EDO), read, write and read modify write cycles are available for each of the consecutive $\overline{\text{CAS}}$ cycles within the same $\overline{\text{RAS}}$ cycle.

Hyper Page Mode (EDO) Byte Late Write Cycle

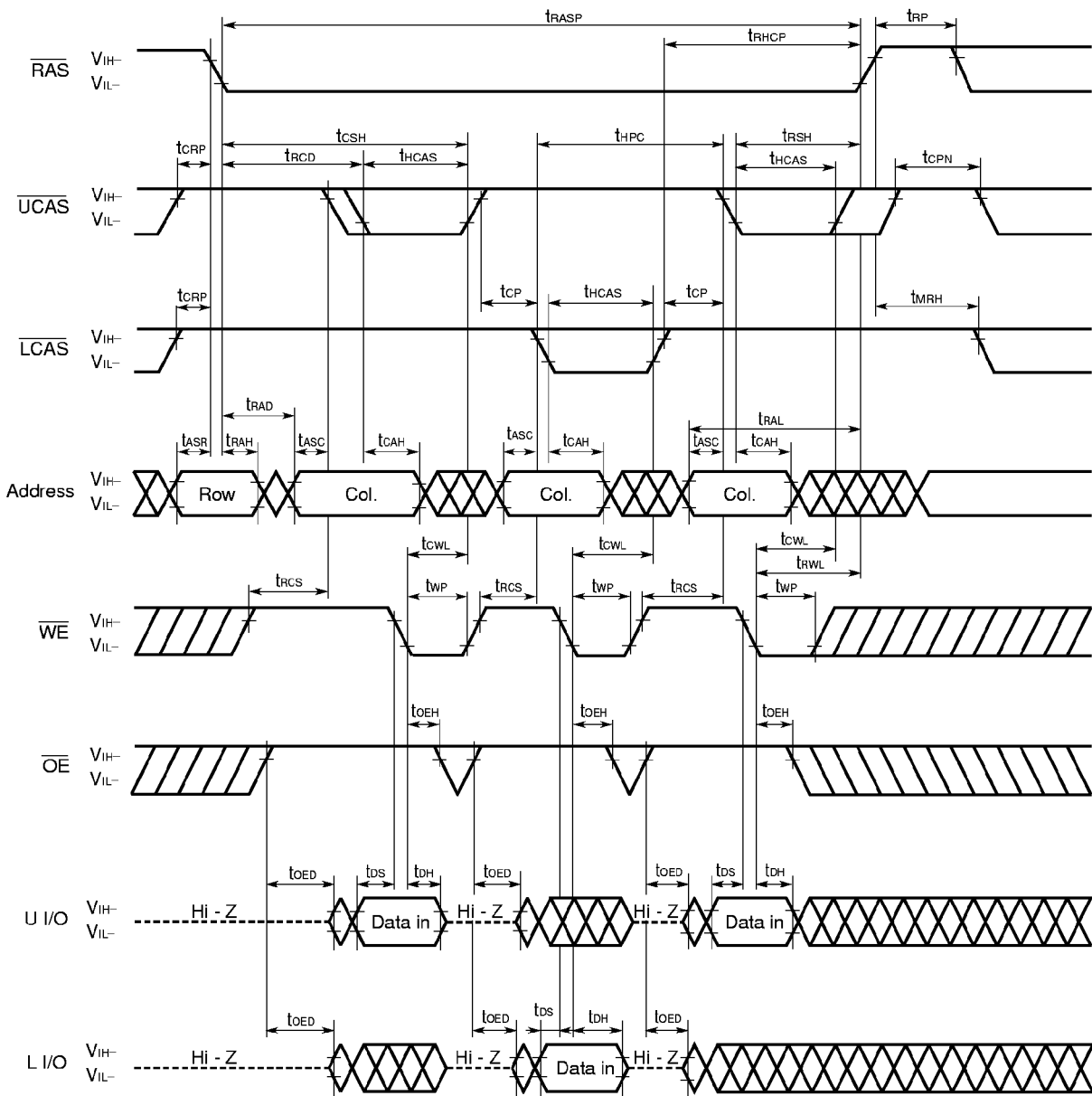

- Remarks**
1. In the hyper page mode (EDO), read, write and read modify write cycles are available for each of the consecutive CAS cycles within the same RAS cycle.
 2. This cycle can be used to control either UCAS or LCAS only. Or, it can be used to control UCAS or LCAS simultaneously, or at random.

Hyper Page Mode (EDO) Read Modify Write Cycle

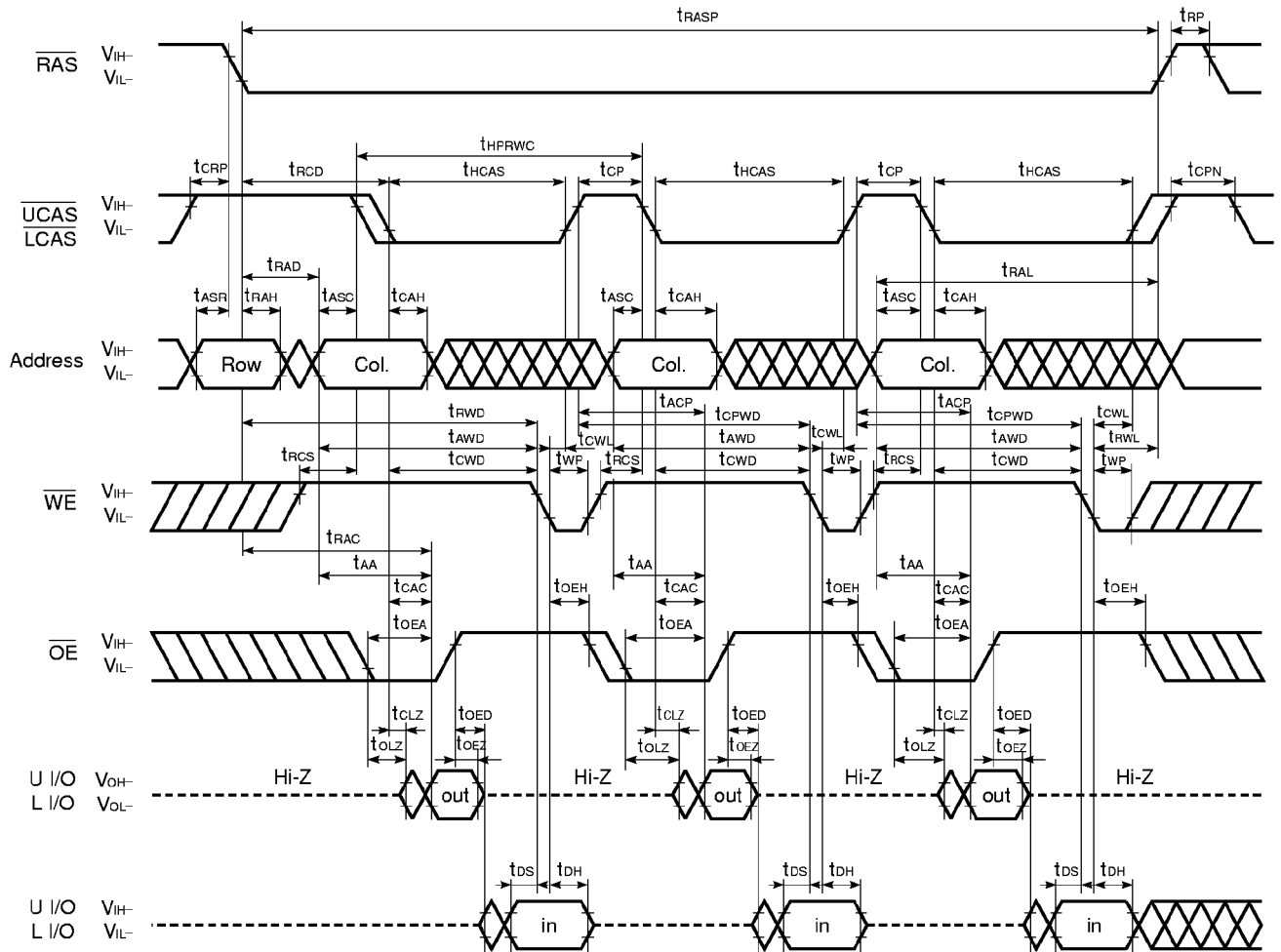

Remark In the hyper page mode (EDO), read, write and read modify write cycles are available for each of the consecutive CAS cycles within the same RAS cycle.

Hyper Page Mode (EDO) Byte Read Modify Write Cycle

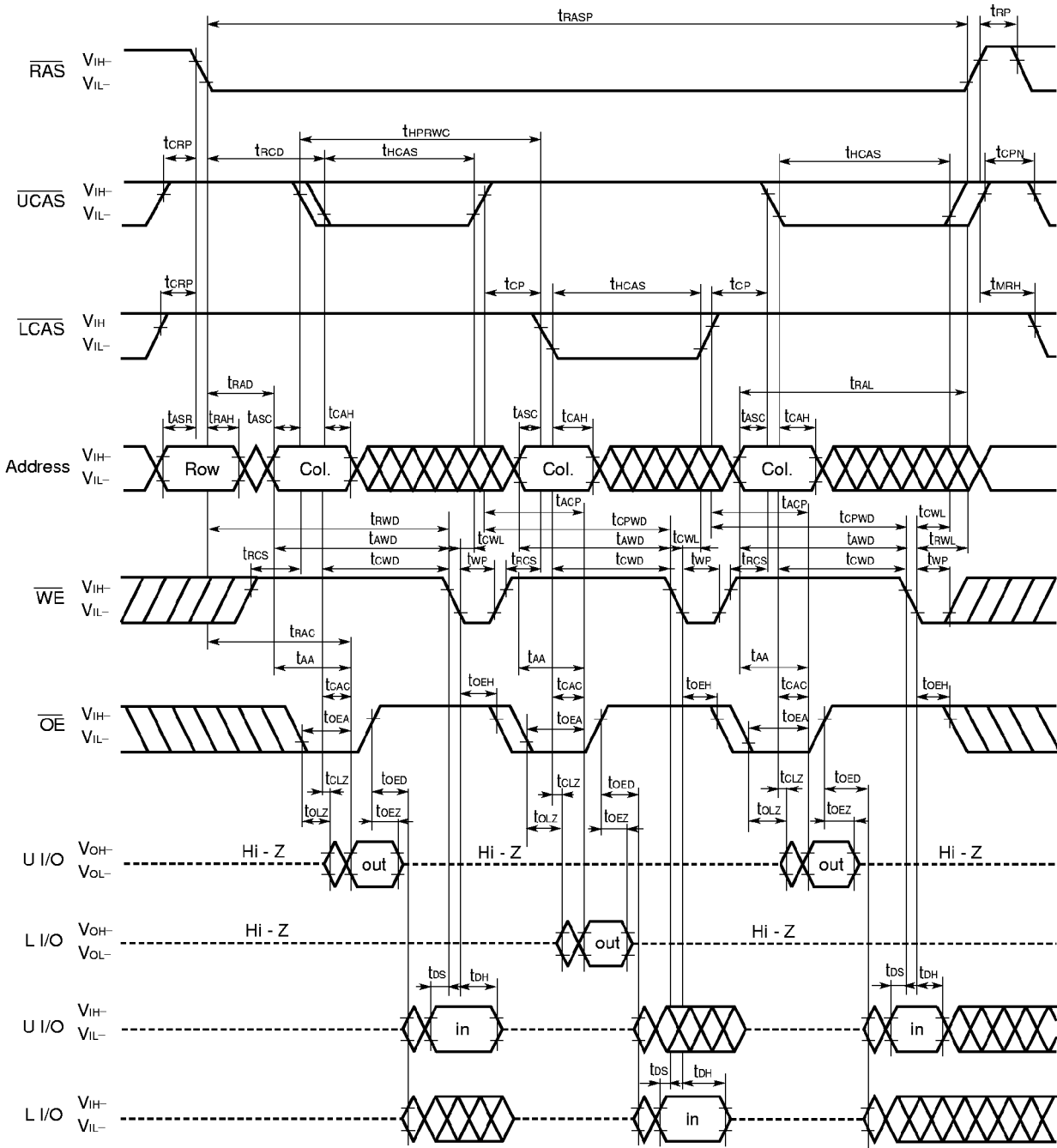

- Remarks**
1. In the hyper page mode (EDO), read, write and read modify write cycles are available for each of the consecutive \overline{CAS} cycles within the same \overline{RAS} cycle.
 2. This cycle can be used to control either \overline{UCAS} or \overline{LCAS} only. Or, it can be used to control \overline{UCAS} or \overline{LCAS} simultaneously, or at random.

Hyper Page Mode (EDO) Read and Write Cycle

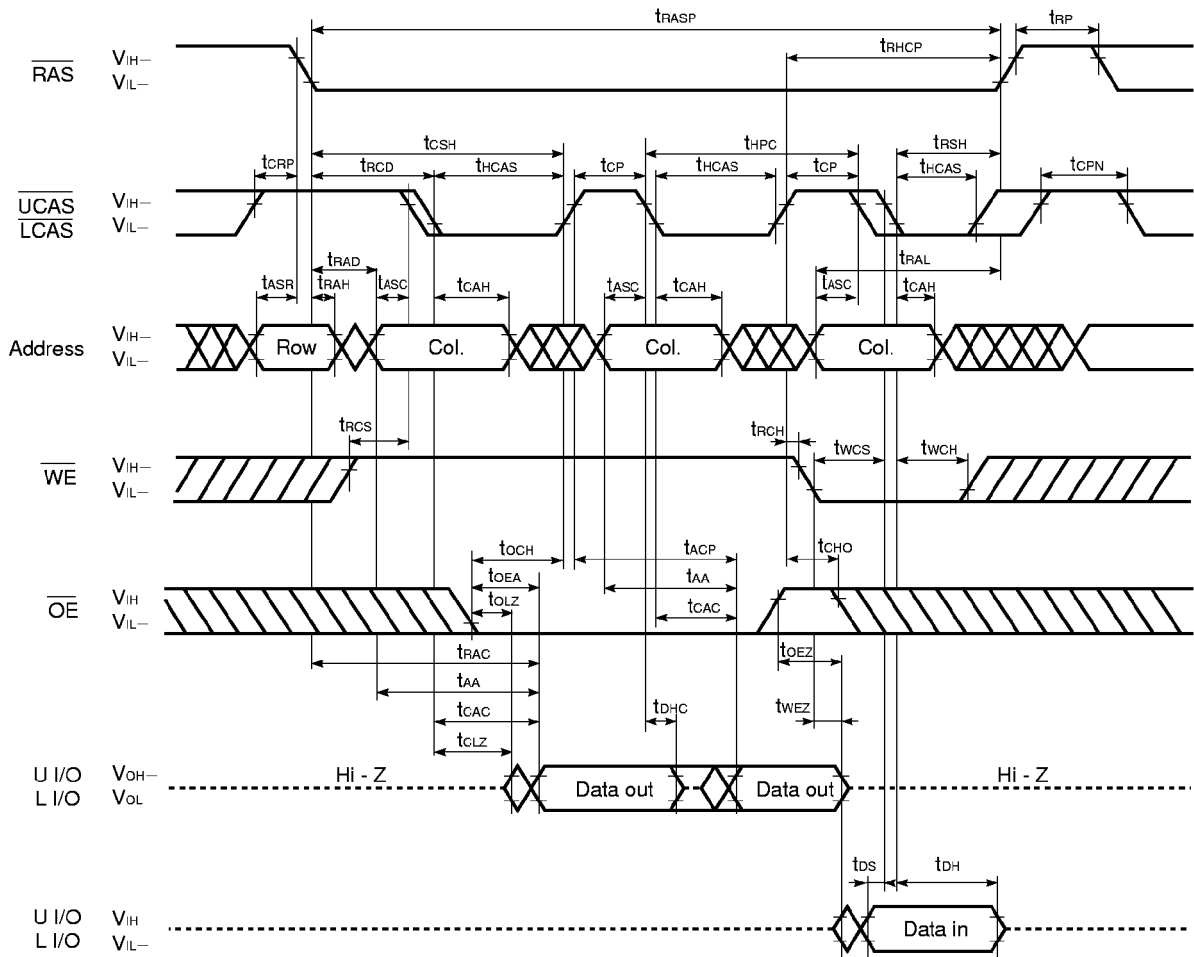

Remark In the hyper page mode (EDO), read, write and read modify write cycles are available for each of the consecutive CAS cycles within the same RAS cycle.

CAS Before RAS Self Refresh Cycle (Only for the μPD42S16165L)

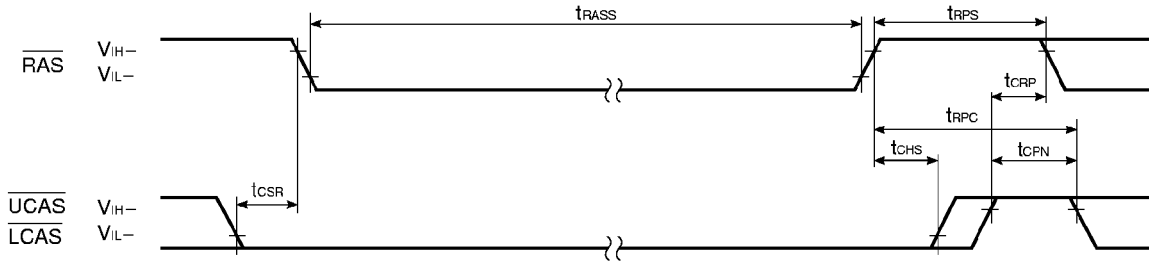

Remark Address, \overline{WE} , \overline{OE} : Don't care L I/O, U I/O: Hi-Z

Cautions on Use of CAS Before RAS Self Refresh

CAS before RAS self refresh can be used independently when used in combination with distributed CAS before RAS long refresh; However, when used in combination with burst CAS before RAS long refresh or with long RAS only refresh (both distributed and burst), the following cautions must be observed.

- (1) **Normal Combined Use of CAS Before RAS Self Refresh and Burst CAS Before RAS Long Refresh**
When CAS before RAS self refresh and burst CAS before RAS long refresh are used in combination, please perform CAS before RAS refresh 4,096 times within a 64 ms interval just before and after setting CAS before RAS self refresh.
- (2) **Normal Combined Use of CAS Before RAS Self Refresh and Long RAS Only Refresh**
When CAS before RAS self refresh and RAS only refresh are used in combination, please perform RAS only refresh 4,096 times within a 64 ms interval just before and after setting CAS before RAS self refresh.
- (3) If $t_{RASS(MIN.)}$ is not satisfied at the beginning of CAS before RAS self refresh cycles ($t_{RAS} < 100 \mu s$), CAS before RAS refresh cycles will be executed one time.
If $10 \mu s < t_{RAS} < 100 \mu s$, RAS precharge time for CAS before RAS self refresh (t_{RPS}) is applied.
And refresh cycles (4,096/128 ms) should be met.

For details, please refer to **How to use DRAM** User's Manual.

CAS Before RAS Refresh Cycle

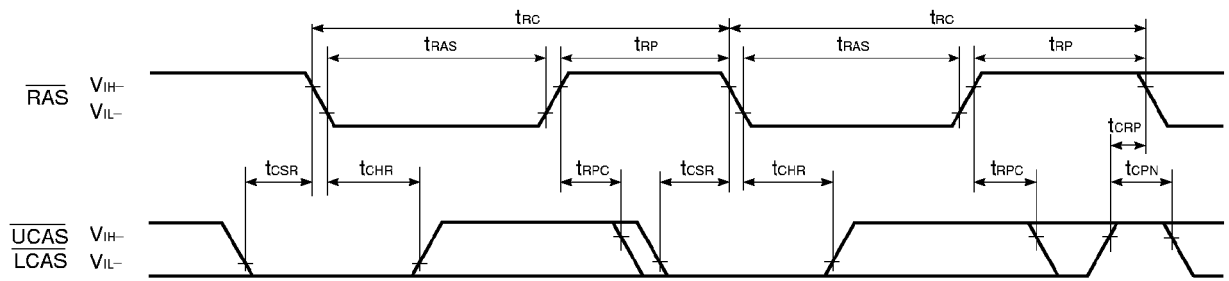

Remark Address, \overline{WE} , \overline{OE} : Don't care L I/O, U I/O: Hi-Z

RAS Only Refresh Cycle

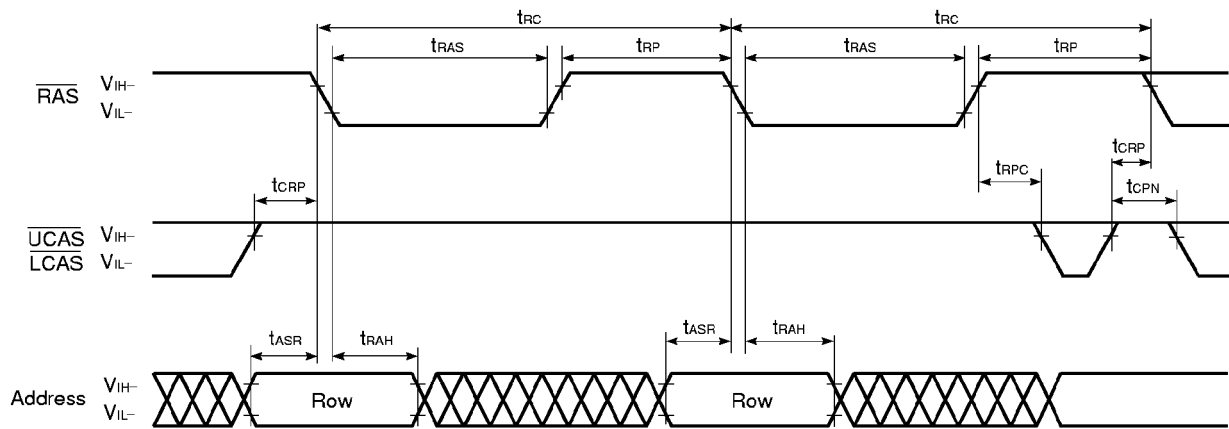

Remark \overline{WE} , \overline{OE} : Don't care L I/O, U I/O: Hi-Z

Hidden Refresh Cycle (Read)

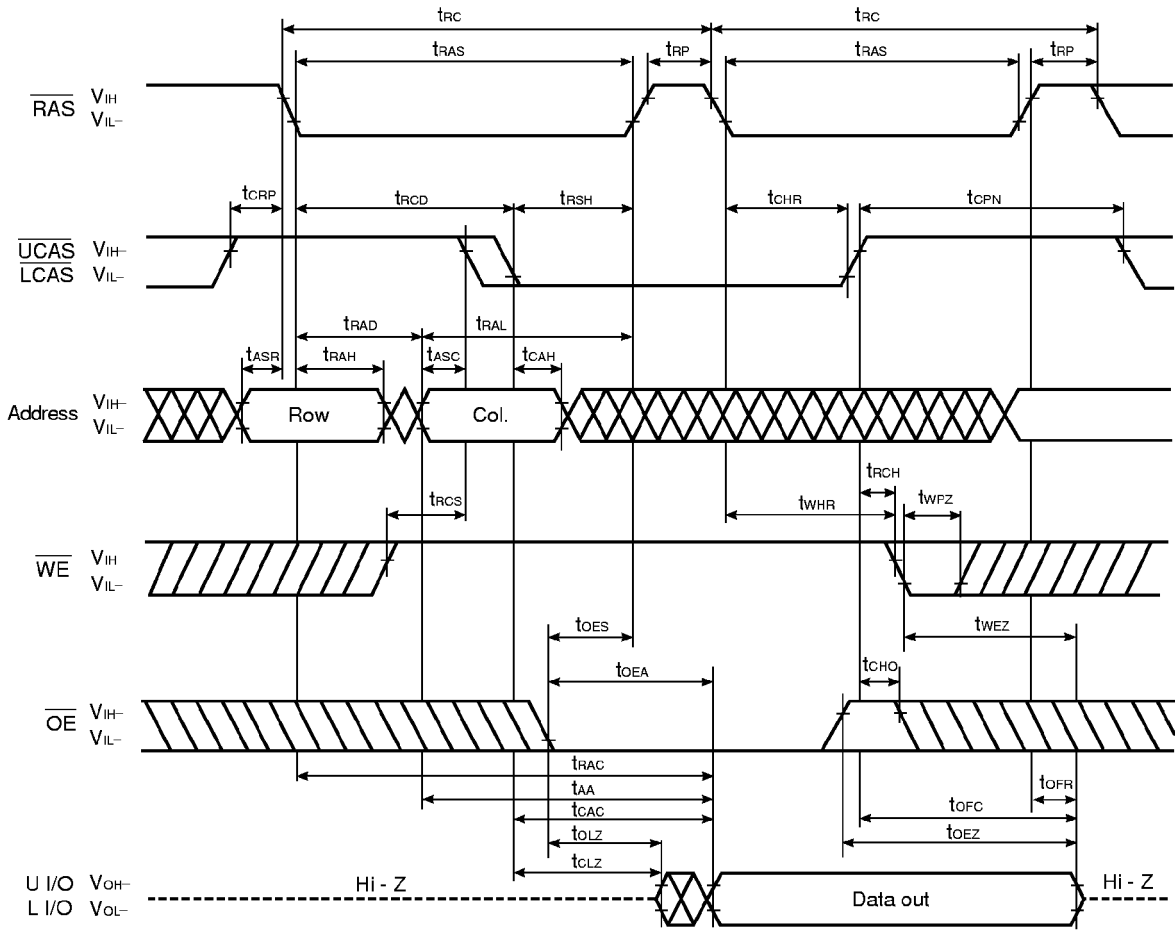

Hidden Refresh Cycle (Write)

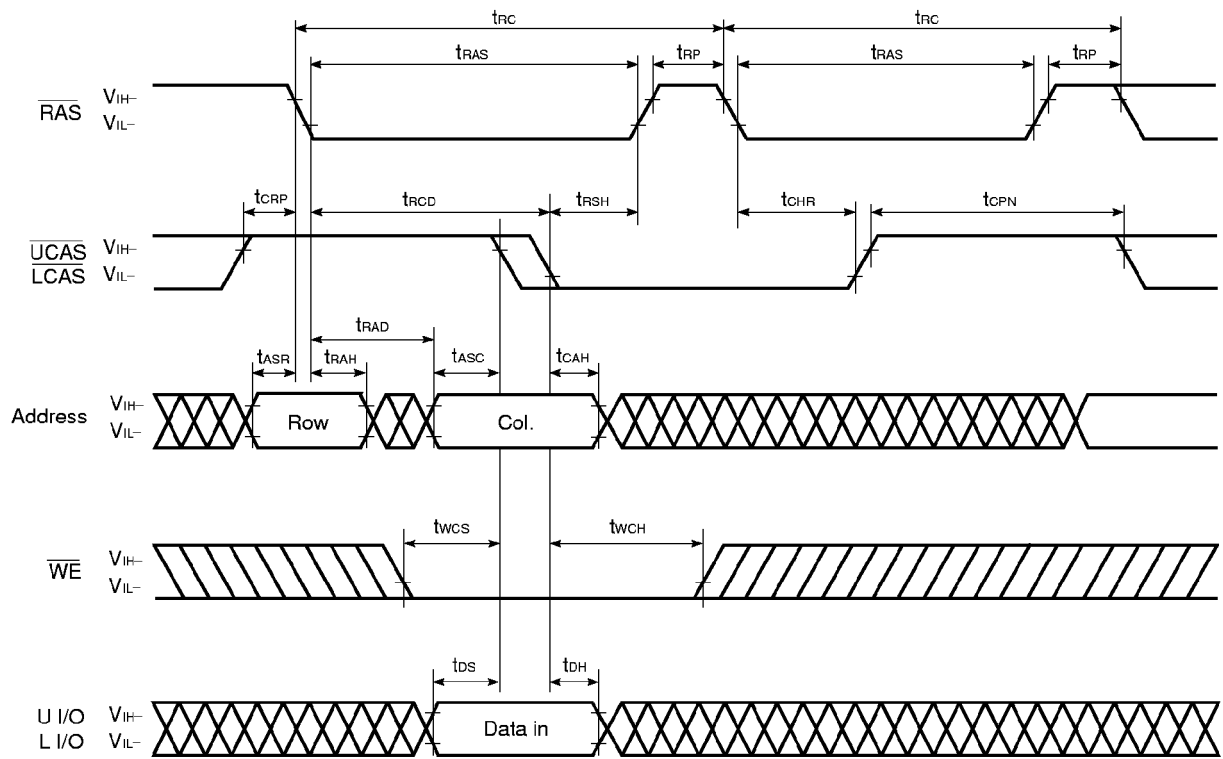

Remark $\overline{\text{OE}}$: Don't care

Package Drawings

50PIN PLASTIC TSOP(II) (400 mil)

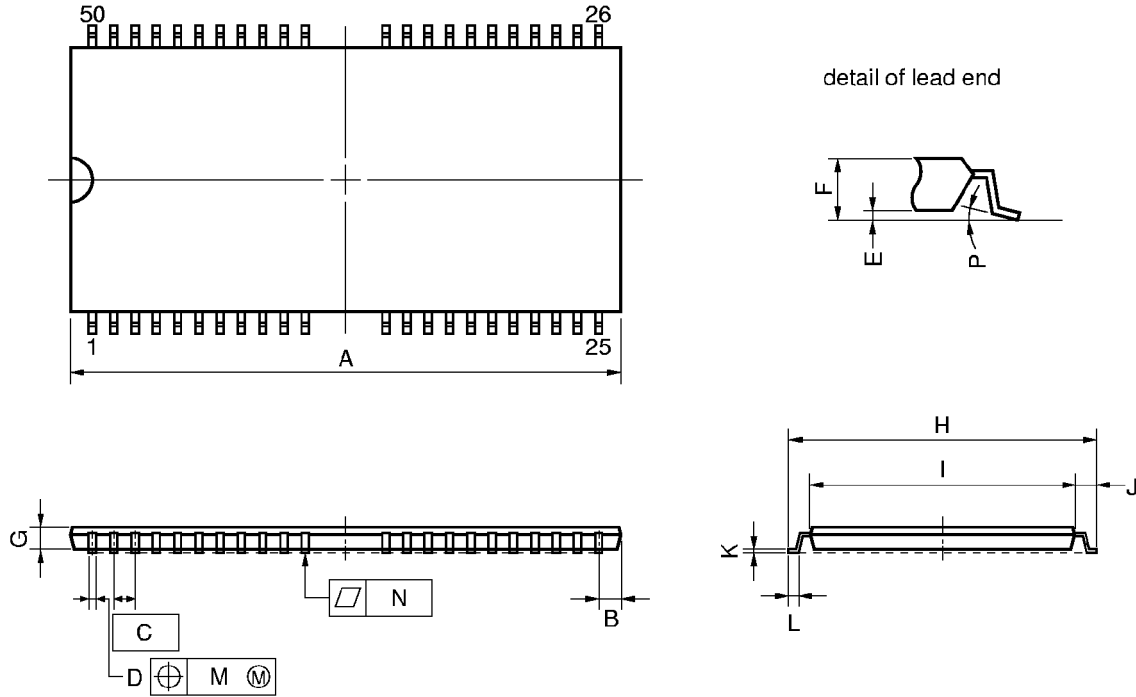

NOTE
 Each lead centerline is located within 0.13 mm (0.005 inch) of its true position (T.P.) at maximum material condition.

ITEM	MILLIMETERS	INCHES
A	21.17 MAX.	0.834 MAX.
B	1.0 MAX.	0.040 MAX.
C	0.8 (T.P.)	0.031 (T.P.)
D	0.32 ^{+0.08} / _{-0.07}	0.013±0.003
E	0.1±0.05	0.004±0.002
F	1.2 MAX.	0.048 MAX.
G	0.97	0.038
H	11.76±0.2	0.463±0.008
I	10.16±0.1	0.400±0.004
J	0.8±0.2	0.031 ^{+0.009} / _{-0.008}
K	0.145 ^{+0.025} / _{-0.015}	0.006±0.001
L	0.5±0.1	0.020 ^{+0.004} / _{-0.005}
M	0.13	0.005
N	0.10	0.004
P	3° ^{+7°} / _{-3°}	3° ^{+7°} / _{-3°}

S50G5-80-7JF4

42 PIN PLASTIC SOJ (400 mil)

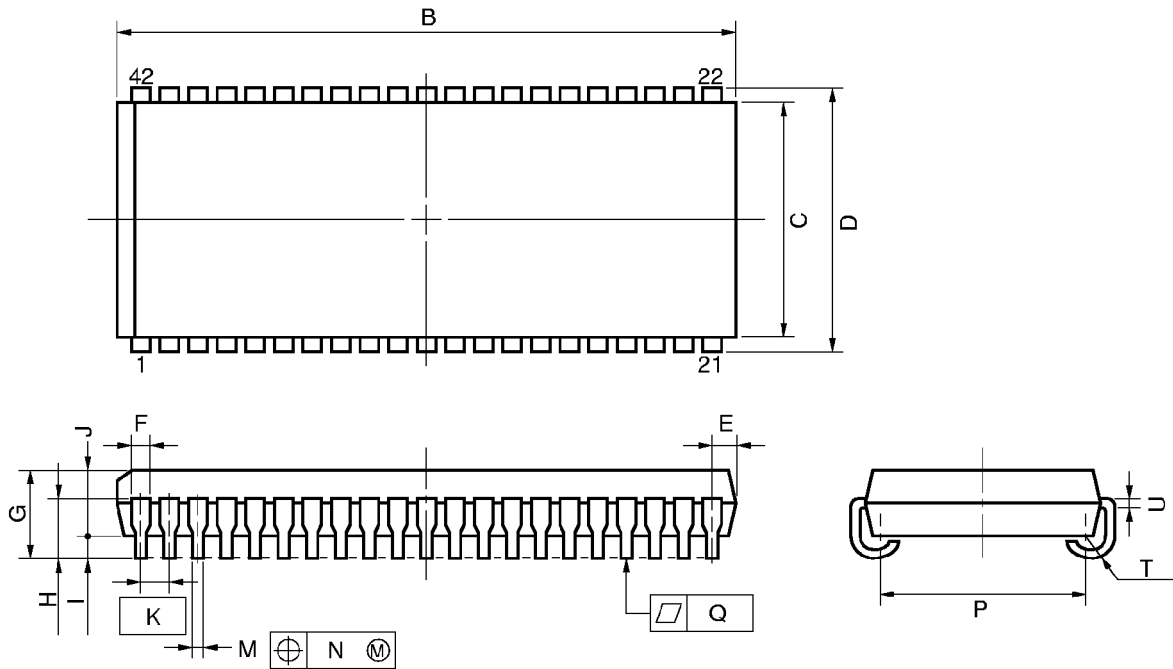

P42LE-400A

NOTE

Each lead centerline is located within 0.12 mm (0.005 inch) of its true position (T.P.) at maximum material condition.

ITEM	MILLIMETERS	INCHES
B	27.56 ^{+0.2} _{-0.35}	1.085 ^{+0.008} _{-0.014}
C	10.16	0.400
D	11.18±0.2	0.440±0.008
E	1.08±0.15	0.043 ^{+0.006} _{-0.007}
F	0.74	0.029
G	3.5±0.2	0.138±0.008
H	2.545±0.2	0.100±0.008
I	0.8 MIN.	0.031 MIN.
J	2.6	0.102
K	1.27 (T.P.)	0.050 (T.P.)
M	0.40±0.10	0.016 ^{+0.004} _{-0.005}
N	0.12	0.005
P	9.4±0.20	0.370±0.008
Q	0.10	0.004
T	R 0.85	R 0.033
U	0.20 ^{+0.10} _{-0.05}	0.008 ^{+0.004} _{-0.002}

★ **Recommended Soldering Conditions**

The following conditions (see tables below and next page) must be met for soldering conditions of the μ PD42S16165L, 4216165L.

For more details, refer to our document “SEMICONDUCTOR DEVICE MOUNTING TECHNOLOGY MANUAL” (C10535E).

Please consult with our sales offices in case other soldering process is used, or in case the soldering is done under different conditions.

Types of Surface Mount Device

μ PD42S16165LG5-7JF, 4216165LG5-7JF: 50-pin plastic TSOP (II) (400 mil)

Soldering process	Soldering conditions	Symbol
Infrared ray reflow	Peak temperature of package surface: 235 °C or lower, Reflow time: 30 seconds or less (210 °C or higher), Number of reflow processes: MAX. 3 Exposure limit: 7 days ^{Note} (10 hours pre-baking is required at 125 °C afterwards)	IR35-107-3
VPS	Peak temperature of package: 215 °C or lower, Reflow time: 40 seconds or less (200 °C or higher), Number of reflow processes: MAX. 3 Exposure limit: 7 days ^{Note} (10 hours pre-baking is required at 125 °C afterwards)	VP15-107-3
Partial heating method	Terminal temperature: 300 °C or lower, Time: 3 seconds or lower (Per side of the package).	—

Note Exposure limit before soldering after dry-pack package is opened.
Storage conditions: 25 °C and relative humidity at 65 % or less.

Caution Do not apply more than one soldering method at any one time, except for “Partial heating method”.

μPD42S16165LLE, 4216165LLE: 42-pin plastic SOJ (400 mil)

Soldering process	Soldering conditions	Symbol
Infrared ray reflow	Peak temperature of package surface: 235 °C or lower, Reflow time: 30 seconds or less (210 °C or higher), Number of reflow processes: MAX. 3 Exposure limit: 7 days ^{Note} (20 hours pre-baking is required at 125 °C afterwards)	IR35-207-3
VPS	Peak temperature of package: 215 °C or lower, Reflow time: 40 seconds or less (200 °C or higher), Number of reflow processes: MAX. 3 Exposure limit: 7 days ^{Note} (20 hours pre-baking is required at 125 °C afterwards)	VP15-207-3
Partial heating method	Terminal temperature: 300 °C or lower, Time: 3 seconds or less (Per side of the package).	—

Note Exposure limit before soldering after dry-pack package is opened.
Storage conditions: 25 °C and relative humidity at 65 % or less.

Caution Do not apply more than one soldering method at any one time, except for “Partial heating method”.