

**MOS INTEGRATED CIRCUIT**  
 **$\mu$ PD44164082, 44164182, 44164362****18M-BIT DDRII SRAM**  
**2-WORD BURST OPERATION****Description**

The  $\mu$ PD44164082 is a 2,097,152-word by 8-bit, the  $\mu$ PD44164182 is a 1,048,576-word by 18-bit and the  $\mu$ PD44164362 is a 524,288-word by 36-bit synchronous double data rate static RAM fabricated with advanced CMOS technology using full CMOS six-transistor memory cell.

The  $\mu$ PD44164082,  $\mu$ PD44164182 and  $\mu$ PD44164362 integrates unique synchronous peripheral circuitry and a burst counter. All input registers controlled by an input clock pair (K and /K) are latched on the positive edge of K and /K.

These products are suitable for application which require synchronous operation, high speed, low voltage, high density and wide bit configuration.

These products are packaged in 165-pin PLASTIC BGA.

**Features**

- $1.8 \pm 0.1$  V power supply and HSTL I/O
- DLL circuitry for wide output data valid window and future frequency scaling
- Pipelined double data rate operation
- Common data input/output bus
- Two-tick burst for low DDR transaction size
- Two input clocks (K and /K) for precise DDR timing at clock rising edges only
- Two output clocks (C and /C) for precise flight time  
and clock skew matching-clock and data delivered together to receiving device
- Internally self-timed write control
- Clock-stop capability with  $\mu$ s restart
- User programmable impedance output
- Fast clock cycle time : 4.0 ns (250 MHz), 5.0 ns (200 MHz), 6.0 ns (167 MHz)
- Simple control logic for easy depth expansion
- JTAG boundary scan

The information in this document is subject to change without notice. Before using this document, please confirm that this is the latest version.  
Not all products and/or types are available in every country. Please check with an NEC Electronics sales representative for availability and additional information.

★ Ordering Information

Part number	Cycle Time ns	Clock Frequency MHz	Organization (word x bit)	Core Supply Voltage V	I/O Interface	Package
μPD44164082F5-E40-EQ1	4.0	250	2 M x 8-bit	1.8 ± 0.1	HSTL	165-pin PLASTIC BGA (13 x 15)
μPD44164082F5-E50-EQ1	5.0	200				
μPD44164082F5-E60-EQ1	6.0	167				
μPD44164182F5-E40-EQ1	4.0	250	1 M x 18-bit			
μPD44164182F5-E50-EQ1	5.0	200				
μPD44164182F5-E60-EQ1	6.0	167				
μPD44164362F5-E50-EQ1	5.0	200	512 K x 36-bit			
μPD44164362F5-E60-EQ1	6.0	167				

Pin Configurations

/xxx indicates active low signal.

165-pin PLASTIC BGA (13 x 15)

(Top View)

[μPD44164082F5-EQ1]

	1	2	3	4	5	6	7	8	9	10	11
A	/CQ	V <sub>SS</sub>	A	R, /W	/NW1	/K	NC	/LD	A	V <sub>SS</sub>	CQ
B	NC	NC	NC	A	NC	K	/NW0	A	NC	NC	DQ3
C	NC	NC	NC	V <sub>SS</sub>	A	A	A	V <sub>SS</sub>	NC	NC	NC
D	NC	NC	NC	V <sub>SS</sub>	V <sub>SS</sub>	V <sub>SS</sub>	V <sub>SS</sub>	V <sub>SS</sub>	NC	NC	NC
E	NC	NC	DQ4	V <sub>DDQ</sub>	V <sub>SS</sub>	V <sub>SS</sub>	V <sub>SS</sub>	V <sub>DDQ</sub>	NC	NC	DQ2
F	NC	NC	NC	V <sub>DDQ</sub>	V <sub>DD</sub>	V <sub>SS</sub>	V <sub>DD</sub>	V <sub>DDQ</sub>	NC	NC	NC
G	NC	NC	DQ5	V <sub>DDQ</sub>	V <sub>DD</sub>	V <sub>SS</sub>	V <sub>DD</sub>	V <sub>DDQ</sub>	NC	NC	NC
H	/DLL	V <sub>REF</sub>	V <sub>DDQ</sub>	V <sub>DDQ</sub>	V <sub>DD</sub>	V <sub>SS</sub>	V <sub>DD</sub>	V <sub>DDQ</sub>	V <sub>DDQ</sub>	V <sub>REF</sub>	ZQ
J	NC	NC	NC	V <sub>DDQ</sub>	V <sub>DD</sub>	V <sub>SS</sub>	V <sub>DD</sub>	V <sub>DDQ</sub>	NC	DQ1	NC
K	NC	NC	NC	V <sub>DDQ</sub>	V <sub>DD</sub>	V <sub>SS</sub>	V <sub>DD</sub>	V <sub>DDQ</sub>	NC	NC	NC
L	NC	DQ6	NC	V <sub>DDQ</sub>	V <sub>SS</sub>	V <sub>SS</sub>	V <sub>SS</sub>	V <sub>DDQ</sub>	NC	NC	DQ0
M	NC	NC	NC	V <sub>SS</sub>	V <sub>SS</sub>	V <sub>SS</sub>	V <sub>SS</sub>	V <sub>SS</sub>	NC	NC	NC
N	NC	NC	NC	V <sub>SS</sub>	A	A	A	V <sub>SS</sub>	NC	NC	NC
P	NC	NC	DQ7	A	A	C	A	A	NC	NC	NC
R	TDO	TCK	A	A	A	/C	A	A	A	TMS	TDI

- |            |                             |                  |                              |
|------------|-----------------------------|------------------|------------------------------|
| A          | : Address inputs            | TMS              | : IEEE 1149.1 Test input     |
| DQ0 to DQ7 | : Data inputs / outputs     | TDI              | : IEEE 1149.1 Test input     |
| /LD        | : Synchronous load          | TCK              | : IEEE 1149.1 Clock input    |
| R, /W      | : Read Write input          | TDO              | : IEEE 1149.1 Test output    |
| /NW0, /NW1 | : Nibble Write data select  | V <sub>REF</sub> | : HSTL input reference input |
| K, /K      | : Input clock               | V <sub>DD</sub>  | : Power Supply               |
| C, /C      | : Output clock              | V <sub>DDQ</sub> | : Power Supply               |
| CQ, /CQ    | : Echo clock                | V <sub>SS</sub>  | : Ground                     |
| ZQ         | : Output impedance matching | NC               | : No connection              |
| /DLL       | : DLL disable               |                  |                              |

Remark Refer to Package Drawing for the index mark.

165-pin PLASTIC BGA (13 x 15)

(Top View)

[μPD44164182F5-EQ1]

	1	2	3	4	5	6	7	8	9	10	11
A	/CQ	V <sub>SS</sub>	A	R, /W	/BW1	/K	NC	/LD	A	V <sub>SS</sub>	CQ
B	NC	DQ9	NC	A	NC	K	/BW0	A	NC	NC	DQ8
C	NC	NC	NC	V <sub>SS</sub>	A	A0	A	V <sub>SS</sub>	NC	DQ7	NC
D	NC	NC	DQ10	V <sub>SS</sub>	V <sub>SS</sub>	V <sub>SS</sub>	V <sub>SS</sub>	V <sub>SS</sub>	NC	NC	NC
E	NC	NC	DQ11	V <sub>DDQ</sub>	V <sub>SS</sub>	V <sub>SS</sub>	V <sub>SS</sub>	V <sub>DDQ</sub>	NC	NC	DQ6
F	NC	DQ12	NC	V <sub>DDQ</sub>	V <sub>DD</sub>	V <sub>SS</sub>	V <sub>DD</sub>	V <sub>DDQ</sub>	NC	NC	DQ5
G	NC	NC	DQ13	V <sub>DDQ</sub>	V <sub>DD</sub>	V <sub>SS</sub>	V <sub>DD</sub>	V <sub>DDQ</sub>	NC	NC	NC
H	/DLL	V <sub>REF</sub>	V <sub>DDQ</sub>	V <sub>DDQ</sub>	V <sub>DD</sub>	V <sub>SS</sub>	V <sub>DD</sub>	V <sub>DDQ</sub>	V <sub>DDQ</sub>	V <sub>REF</sub>	ZQ
J	NC	NC	NC	V <sub>DDQ</sub>	V <sub>DD</sub>	V <sub>SS</sub>	V <sub>DD</sub>	V <sub>DDQ</sub>	NC	DQ4	NC
K	NC	NC	DQ14	V <sub>DDQ</sub>	V <sub>DD</sub>	V <sub>SS</sub>	V <sub>DD</sub>	V <sub>DDQ</sub>	NC	NC	DQ3
L	NC	DQ15	NC	V <sub>DDQ</sub>	V <sub>SS</sub>	V <sub>SS</sub>	V <sub>SS</sub>	V <sub>DDQ</sub>	NC	NC	DQ2
M	NC	NC	NC	V <sub>SS</sub>	V <sub>SS</sub>	V <sub>SS</sub>	V <sub>SS</sub>	V <sub>SS</sub>	NC	DQ1	NC
N	NC	NC	DQ16	V <sub>SS</sub>	A	A	A	V <sub>SS</sub>	NC	NC	NC
P	NC	NC	DQ17	A	A	C	A	A	NC	NC	DQ0
R	TDO	TCK	A	A	A	/C	A	A	A	TMS	TDI

- |             |                             |                  |                              |
|-------------|-----------------------------|------------------|------------------------------|
| A0, A       | : Address inputs            | TMS              | : IEEE 1149.1 Test input     |
| DQ0 to DQ17 | : Data inputs / outputs     | TDI              | : IEEE 1149.1 Test input     |
| /LD         | : Synchronous load          | TCK              | : IEEE 1149.1 Clock input    |
| R, /W       | : Read Write input          | TDO              | : IEEE 1149.1 Test output    |
| /BW0, /BW1  | : Byte Write data select    | V <sub>REF</sub> | : HSTL input reference input |
| K, /K       | : Input clock               | V <sub>DD</sub>  | : Power Supply               |
| C, /C       | : Output clock              | V <sub>DDQ</sub> | : Power Supply               |
| CQ, /CQ     | : Echo clock                | V <sub>SS</sub>  | : Ground                     |
| ZQ          | : Output impedance matching | NC               | : No connection              |
| /DLL        | : DLL disable               |                  |                              |

**Remark** Refer to **Package Drawing** for the index mark.

165-pin PLASTIC BGA (13 x 15)

(Top View)

[μPD44164362F5-EQ1]

	1	2	3	4	5	6	7	8	9	10	11
A	/CQ	V <sub>SS</sub>	NC	R, /W	/BW2	/K	/BW1	/LD	A	V <sub>SS</sub>	CQ
B	NC	DQ27	DQ18	A	/BW3	K	/BW0	A	NC	NC	DQ8
C	NC	NC	DQ28	V <sub>SS</sub>	A	A0	A	V <sub>SS</sub>	NC	DQ17	DQ7
D	NC	DQ29	DQ19	V <sub>SS</sub>	V <sub>SS</sub>	V <sub>SS</sub>	V <sub>SS</sub>	V <sub>SS</sub>	NC	NC	DQ16
E	NC	NC	DQ20	V <sub>DDQ</sub>	V <sub>SS</sub>	V <sub>SS</sub>	V <sub>SS</sub>	V <sub>DDQ</sub>	NC	DQ15	DQ6
F	NC	DQ30	DQ21	V <sub>DDQ</sub>	V <sub>DD</sub>	V <sub>SS</sub>	V <sub>DD</sub>	V <sub>DDQ</sub>	NC	NC	DQ5
G	NC	DQ31	DQ22	V <sub>DDQ</sub>	V <sub>DD</sub>	V <sub>SS</sub>	V <sub>DD</sub>	V <sub>DDQ</sub>	NC	NC	DQ14
H	/DLL	V <sub>REF</sub>	V <sub>DDQ</sub>	V <sub>DDQ</sub>	V <sub>DD</sub>	V <sub>SS</sub>	V <sub>DD</sub>	V <sub>DDQ</sub>	V <sub>DDQ</sub>	V <sub>REF</sub>	ZQ
J	NC	NC	DQ32	V <sub>DDQ</sub>	V <sub>DD</sub>	V <sub>SS</sub>	V <sub>DD</sub>	V <sub>DDQ</sub>	NC	DQ13	DQ4
K	NC	NC	DQ23	V <sub>DDQ</sub>	V <sub>DD</sub>	V <sub>SS</sub>	V <sub>DD</sub>	V <sub>DDQ</sub>	NC	DQ12	DQ3
L	NC	DQ33	DQ24	V <sub>DDQ</sub>	V <sub>SS</sub>	V <sub>SS</sub>	V <sub>SS</sub>	V <sub>DDQ</sub>	NC	NC	DQ2
M	NC	NC	DQ34	V <sub>SS</sub>	V <sub>SS</sub>	V <sub>SS</sub>	V <sub>SS</sub>	V <sub>SS</sub>	NC	DQ11	DQ1
N	NC	DQ35	DQ25	V <sub>SS</sub>	A	A	A	V <sub>SS</sub>	NC	NC	DQ10
P	NC	NC	DQ26	A	A	C	A	A	NC	DQ9	DQ0
R	TDO	TCK	A	A	A	/C	A	A	A	TMS	TDI

- |              |                             |                  |                              |
|--------------|-----------------------------|------------------|------------------------------|
| A0, A        | : Address inputs            | TMS              | : IEEE 1149.1 Test input     |
| DQ0 to DQ35  | : Data inputs / outputs     | TDI              | : IEEE 1149.1 Test input     |
| /LD          | : Synchronous load          | TCK              | : IEEE 1149.1 Clock input    |
| R, /W        | : Read Write input          | TDO              | : IEEE 1149.1 Test output    |
| /BW0 to /BW3 | : Byte Write data select    | V <sub>REF</sub> | : HSTL input reference input |
| K, /K        | : Input clock               | V <sub>DD</sub>  | : Power Supply               |
| C, /C        | : Output clock              | V <sub>DDQ</sub> | : Power Supply               |
| CQ, /CQ      | : Echo clock                | V <sub>SS</sub>  | : Ground                     |
| ZQ           | : Output impedance matching | NC               | : No connection              |
| /DLL         | : DLL disable               |                  |                              |

**Remark** Refer to **Package Drawing** for the index mark.

Pin Identification

Symbol	Description
A0 A	Synchronous Address Inputs: These inputs are registered and must meet the setup and hold times around the rising edge of K. Balls 3A, 10A, and 2A are reserved for the next higher-order address inputs on future devices. All transactions operate on a burst of two words (one clock period of bus activity). A0 is used as the lowest order address bit permitting a random starting address within the burst operation. These inputs are ignored when device is deselected.
DQ0 to DQxx	Synchronous Data IOs: Input data must meet setup and hold times around the rising edges of K and /K. Output data is synchronized to the respective C and /C data clocks or to K and /K if C and /C are tied to HIGH. x8 device uses DQ0 to DQ7. x18 device uses DQ0 to DQ17. x36 device uses DQ0 to DQ35.
/LD	Synchronous Load: This input is brought LOW when a bus cycle sequence is to be defined. This definition includes address and read/write direction. All transactions operate on a burst of 2 data (one clock period of bus activity).
R, /W	Synchronous Read/Write Input: When /LD is LOW, this input designates the access type (READ when R, /W is HIGH, WRITE when R, /W is LOW) for the loaded address. R, /W must meet the setup and hold times around the rising edge of K.
/BWx /NWx	Synchronous Byte Writes (Nibble Writes on x8): When LOW these inputs cause their respective byte or nibble to be registered and written during WRITE cycles. These signals must meet setup and hold times around the rising edges of K and /K for each of the two rising edges comprising the WRITE cycle. See Pin Configurations for signal to data relationships.
K, /K	Input Clock: This input clock pair registers address and control inputs on the rising edge of K, and registers data on the rising edge of K and the rising edge of /K. /K is ideally 180 degrees out of phase with K. All synchronous inputs must meet setup and hold times around the clock rising edges.
C, /C	Output Clock: This clock pair provides a user controlled means of tuning device output data. The rising edge of /C is used as the output timing reference for first output data. The rising edge of C is used as the output reference for second output data. Ideally, /C is 180 degrees out of phase with C. C and /C may be tied HIGH to force the use of K and /K as the output reference clocks instead of having to provide C and /C clocks. If tied HIGH, C and /C must remain HIGH and not be toggled during device operation.
CQ, /CQ	Synchronous Echo Clock Outputs. The rising edges of these outputs are tightly matched to the synchronous data outputs and can be used as a data valid indication. These signals run freely and do not stop when Q tristates.
ZQ	Output Impedance Matching Input: This input is used to tune the device outputs to the system data bus impedance. DQ and CQ output impedance are set to $0.2 \times RQ$ , where RQ is a resistor from this bump to ground. This pin cannot be connected directly to GND or left unconnected. Also, in this product, there is no function to minimize the output impedance by connecting ZQ directly to V <sub>DDQ</sub> .
/DLL	DLL Disable: When LOW, this input causes the DLL to be bypassed for stable low frequency operation.
TMS TDI	IEEE 1149.1 Test Inputs: 1.8V I/O levels. These balls may be left Not Connected if the JTAG function is not used in the circuit.
TCK	IEEE 1149.1 Clock Input: 1.8V I/O levels. This pin must be tied to V <sub>SS</sub> if the JTAG function is not used in the circuit.
TDO	IEEE 1149.1 Test Output: 1.8V I/O level.
VREF	HSTL Input Reference Voltage: Nominally V <sub>DDQ</sub> /2. Provides a reference voltage for the input buffers.
VDD	Power Supply: 1.8V nominal. See DC Characteristics and Operating Conditions for range.
V <sub>DDQ</sub>	Power Supply: Isolated Output Buffer Supply. Nominally 1.5V. 1.8V is also permissible. See DC Characteristics and Operating Conditions for range.
V <sub>SS</sub>	Power Supply: Ground
NC	No Connect: These signals are internally connected and appear in the JTAG scan chain as the logic level applied to the ball sites. These signals may be connected to ground to improve package heat dissipation.

Block Diagram

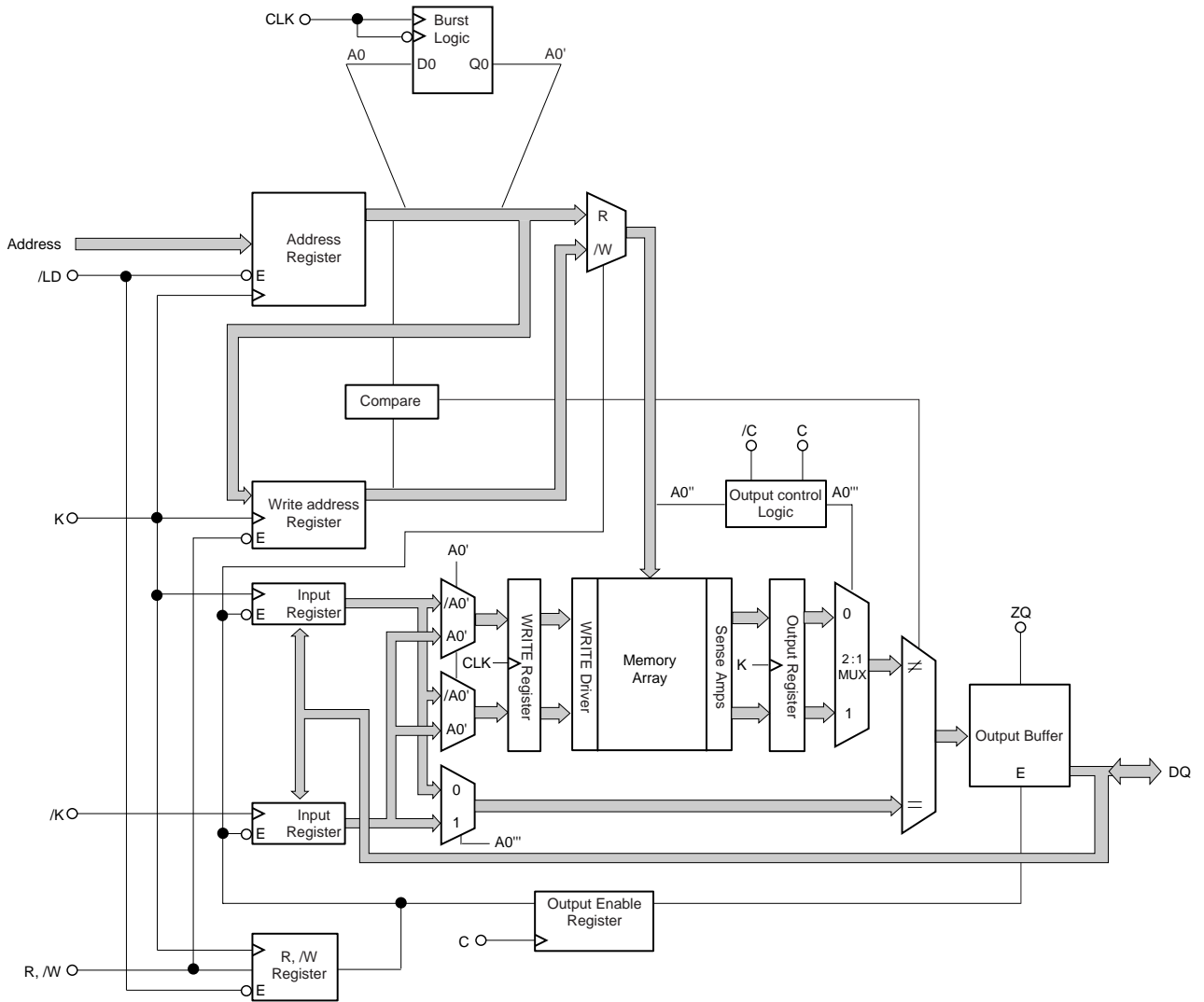

**Burst Sequence**

**Linear Burst Sequence Table**

[μPD44164182, μPD44164362]

	A0	A0
External Address	0	1
1st Internal Burst Address	1	0

**Truth Table**

Operation	/LD	R, /W	CLK	DQ		
WRITE cycle Load address, input write data on two consecutive K and /K rising edge	L	L	L → H	Data in		
				Input data	D(A1)	D(A2)
				Input clock	K(t+1) ↑	/K(t+1) ↑
READ cycle Load address, read data on two consecutive C and /C rising edge	L	H	L → H	Data out		
				Output data	Q(A1)	Q(A2)
				Output clock	/C(t+1) ↑	C(t+2) ↑
NOP (No operation)	H	X	L → H	High-Z		
STANDBY(Clock stopped)	X	X	Stopped	Previous state		

- Remarks**
1. H : High level, L : Low level, x : don't care, ↑ : rising edge.
  2. Data inputs are registered at K and /K rising edges. Data outputs are delivered at C and /C rising edges except if C and /C are HIGH then Data outputs are delivered at K and /K rising edges.
  3. All control inputs in the truth table must meet setup/hold times around the rising edge (LOW to HIGH) of K. All control inputs are registered during the rising edge of K.
  4. This device contains circuitry that will ensure the outputs will be in high impedance during power-up.
  5. Refer to state diagram and timing diagrams for clarification.
  6. A1 refers to the address input during a WRITE or READ cycle. A2 refers to the next internal burst address in accordance with the linear burst sequence.
  7. It is recommended that K = /K = C = /C when clock is stopped. This is not essential but permits most rapid restart by overcoming transmission line charging symmetrically.



Byte Write Operation

[μPD44164082]

Operation	K	/K	/NW0	/NW1
Write DQ0 to DQ7	L → H	–	0	0
	–	L → H	0	0
Write DQ0 to DQ3	L → H	–	0	1
	–	L → H	0	1
Write DQ4 to DQ7	L → H	–	1	0
	–	L → H	1	0
Write nothing	L → H	–	1	1
	–	L → H	1	1

**Remark** H : High level, L : Low level, → : rising edge.

[μPD44164182]

Operation	K	/K	/BW0	/BW1
Write DQ0 to DQ17	L → H	–	0	0
	–	L → H	0	0
Write DQ0 to DQ8	L → H	–	0	1
	–	L → H	0	1
Write DQ9 to DQ17	L → H	–	1	0
	–	L → H	1	0
Write nothing	L → H	–	1	1
	–	L → H	1	1

**Remark** H : High level, L : Low level, → : rising edge.

[μPD44164362]

Operation	K	/K	/BW0	/BW1	/BW2	/BW3
Write DQ0 to DQ35	L → H	–	0	0	0	0
	–	L → H	0	0	0	0
Write DQ0 to DQ8	L → H	–	0	1	1	1
	–	L → H	0	1	1	1
Write DQ9 to DQ17	L → H	–	1	0	1	1
	–	L → H	1	0	1	1
Write DQ18 to DQ26	L → H	–	1	1	0	1
	–	L → H	1	1	0	1
Write DQ27 to DQ35	L → H	–	1	1	1	0
	–	L → H	1	1	1	0
Write nothing	L → H	–	1	1	1	1
	–	L → H	1	1	1	1

**Remark** H : High level, L : Low level, → : rising edge.

Bus Cycle State Diagram

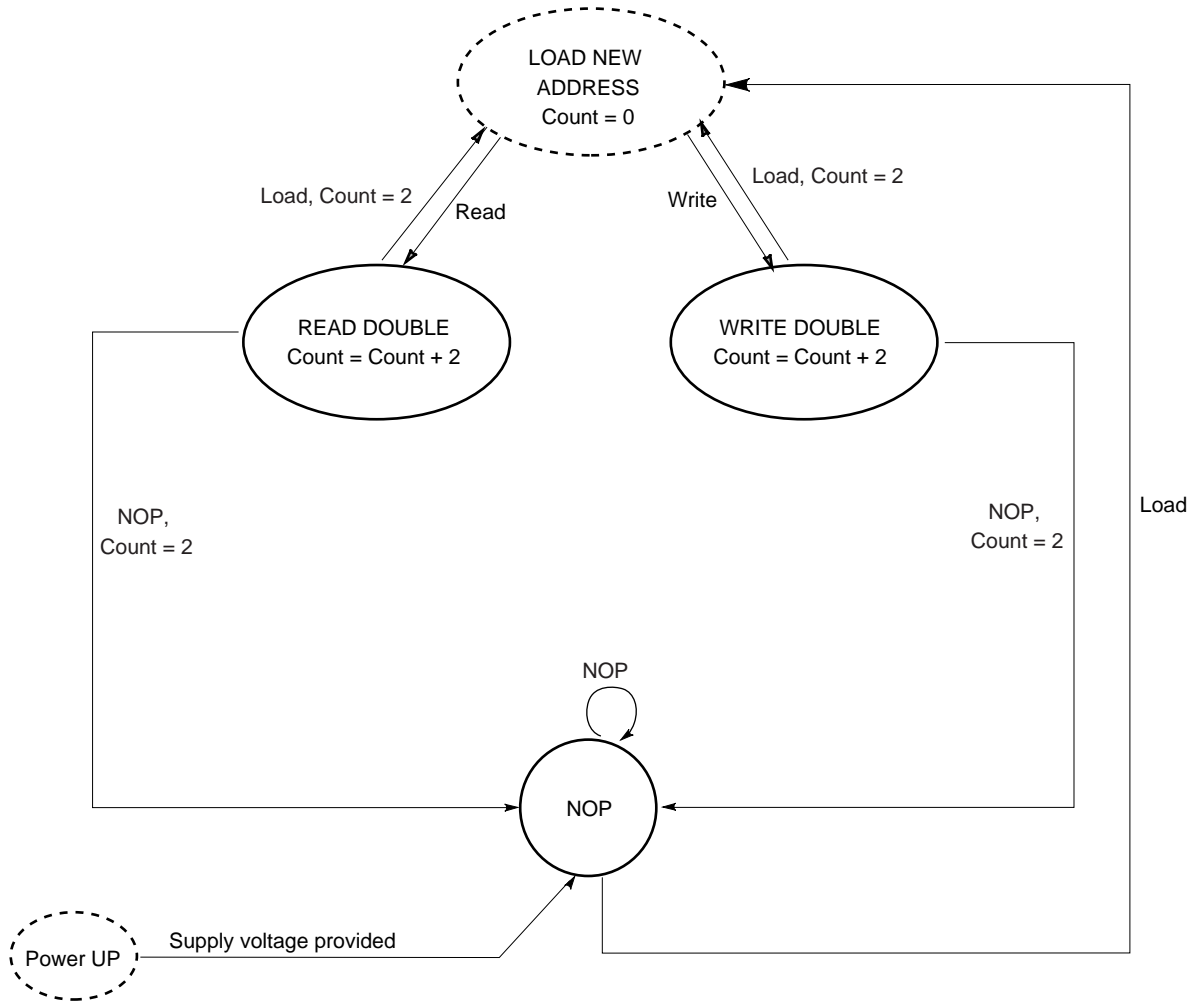

- Remarks**
1. A0 is internally advanced in accordance with the burst order table.  
Bus cycle is terminated after burst count = 2.
  2. State machine control timing sequence is controlled by K.

**Electrical Specifications**

**Absolute Maximum Ratings**

Parameter	Symbol	Conditions	MIN.	TYP.	MAX.	Unit
Supply voltage	V <sub>DD</sub>		-0.5		+2.9	V
Output supply voltage	V <sub>DDQ</sub>		-0.5		V <sub>DD</sub>	V
Input voltage	V <sub>IN</sub>		-0.5		V <sub>DD</sub> + 0.5 (2.9 V MAX.)	V
Input / Output voltage	V <sub>I/O</sub>		-0.5		V <sub>DDQ</sub> + 0.5 (2.9 V MAX.)	V
Operating ambient temperature	T <sub>A</sub>		0		70	°C
Storage temperature	T <sub>stg</sub>		-55		+125	°C

**Caution** Exposing the device to stress above those listed in Absolute Maximum Ratings could cause permanent damage. The device is not meant to be operated under conditions outside the limits described in the operational section of this specification. Exposure to Absolute Maximum Rating conditions for extended periods may affect device reliability.

**Recommended DC Operating Conditions (T<sub>A</sub> = 0 to 70 °C)**

Parameter	Symbol	Conditions	MIN.	TYP.	MAX.	Unit	Note
Supply voltage	V <sub>DD</sub>		1.7		1.9	V	
Output supply voltage	V <sub>DDQ</sub>		1.4		V <sub>DD</sub>	V	1
High level input voltage	V <sub>IH</sub> (DC)		V <sub>REF</sub> + 0.1		V <sub>DDQ</sub> + 0.3	V	1, 2
Low level input voltage	V <sub>IL</sub> (DC)		-0.3		V <sub>REF</sub> - 0.1	V	1, 2
Clock input voltage	V <sub>IN</sub>		-0.3		V <sub>DDQ</sub> + 0.3	V	1, 2
Reference voltage	V <sub>REF</sub>		0.68		0.95	V	

- Notes**
1. During normal operation, V<sub>DDQ</sub> must not exceed V<sub>DD</sub>.
  2. Power-up: V<sub>IH</sub> ≤ V<sub>DDQ</sub> + 0.3 V and V<sub>DD</sub> ≤ 1.7 V and V<sub>DDQ</sub> ≤ 1.4 V for t ≤ 200 ms

**Recommended AC Operating Conditions (T<sub>A</sub> = 0 to 70 °C)**

Parameter	Symbol	Conditions	MIN.	TYP.	MAX.	Unit	Note
High level input voltage	V <sub>IH</sub> (AC)		V <sub>REF</sub> + 0.2		-	V	1
Low level input voltage	V <sub>IL</sub> (AC)		-		V <sub>REF</sub> - 0.2	V	1

- Note 1.** Overshoot: V<sub>IH</sub> (AC) ≤ V<sub>DD</sub> + 0.7 V for t ≤ TKHKH/2  
 Undershoot: V<sub>IL</sub> (AC) ≥ - 0.5 V for t ≤ TKHKH/2  
 Control input signals may not have pulse widths less than TKHKL (MIN.) or operate at cycle rates less than TKHKH (MIN.).

DC Characteristics (T<sub>A</sub> = 0 to 70°C, V<sub>DD</sub> = 1.8 ± 0.1 V)

Parameter	Symbol	Test condition	MIN.	TYP.	MAX.		Unit	Note
					x8, x18	x36		
Input leakage current	I <sub>LI</sub>		-2	-	+2		μA	
I/O leakage current	I <sub>LO</sub>		-2	-	+2		μA	
★ Operating supply current (Read Write cycle)	I <sub>DD</sub>	V <sub>IN</sub> ≤ V <sub>IL</sub> or V <sub>IN</sub> ≥ V <sub>IH</sub> , I <sub>I/O</sub> = 0 mA Cycle = MAX.	-E40		650	-	mA	
-E50				550	650			
-E60				480	570			
★ Standby supply current (NOP)	I <sub>SB1</sub>	V <sub>IN</sub> ≤ V <sub>IL</sub> or V <sub>IN</sub> ≥ V <sub>IH</sub> , I <sub>I/O</sub> = 0 mA Cycle = MAX.	-E40		320	-	mA	
-E50				270				
-E60				250				
High level output voltage	V <sub>OH(Low)</sub>	I <sub>OH</sub>   ≤ 0.1 mA	V <sub>DDQ</sub> - 0.2	-	V <sub>DDQ</sub>		V	3, 4
	V <sub>OH</sub>	Note1	V <sub>DDQ</sub> /2 - 0.12	-	V <sub>DDQ</sub> /2 + 0.12		V	3, 4
Low level output voltage	V <sub>OL(Low)</sub>	I <sub>OL</sub> ≤ 0.1 mA	V <sub>SS</sub>	-	0.2		V	3, 4
	V <sub>OL</sub>	Note2	V <sub>DDQ</sub> /2 - 0.12	-	V <sub>DDQ</sub> /2 + 0.12		V	3, 4

- Notes**
1. Outputs are impedance-controlled. |I<sub>OH</sub>| = (V<sub>DDQ</sub>/2)/(R<sub>Q</sub>/5) for values of 175 Ω ≤ R<sub>Q</sub> ≤ 350 Ω.
  2. Outputs are impedance-controlled. I<sub>OL</sub> = (V<sub>DDQ</sub>/2)/(R<sub>Q</sub>/5) for values of 175 Ω ≤ R<sub>Q</sub> ≤ 350 Ω.
  3. AC load current is higher than the shown DC values.
  4. HSTL outputs meet JEDEC HSTL Class I and Class II standards.

Capacitance (T<sub>A</sub> = 25 °C, f = 1MHz)

Parameter	Symbol	Test conditions	MIN.	TYP.	MAX.	Unit
Input capacitance	C <sub>IN</sub>	V <sub>IN</sub> = 0 V		4	5	pF
Input / Output capacitance	C <sub>I/O</sub>	V <sub>I/O</sub> = 0 V		6	7	pF
Clock Input capacitance	C <sub>clk</sub>	V <sub>clk</sub> = 0 V		5	6	pF

**Remark** These parameters are periodically sampled and not 100% tested.

AC Characteristics ( $T_A = 0$  to  $70$  °C,  $V_{DD} = 1.8 \pm 0.1$  V)

AC Test Conditions

Input waveform (Rise / Fall time  $\leq 0.3$  ns)

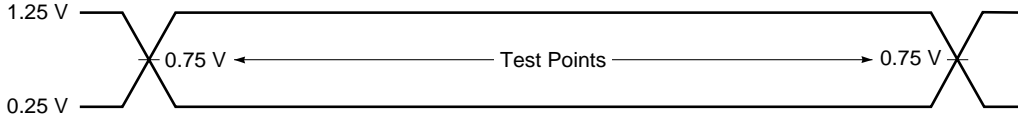

Output waveform

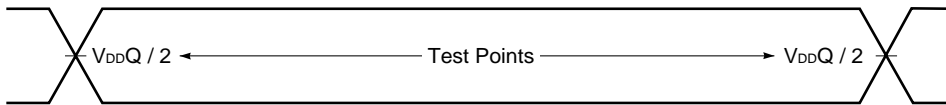

Output load condition

Figure 1. External load at test

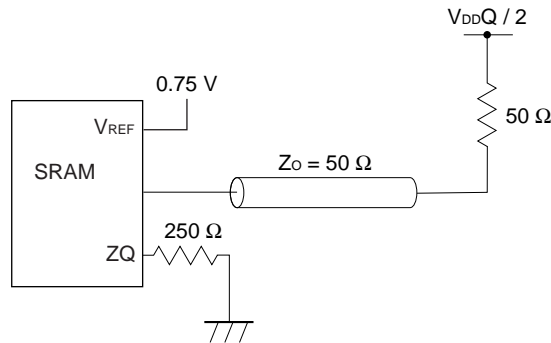

Read and Write Cycle

Parameter	Symbol	-E40 (250 MHz)		-E50 (200 MHz)		-E60 (167 MHz)		Unit	Note	
		MIN.	MAX.	MIN.	MAX.	MIN.	MAX.			
<b>Clock</b>										
Average Clock cycle time (K, /K, C, /C)	TKHKH	4.0	8.4	5.0	8.4	6.0	8.4	ns	1	
Clock phase jitter (K, /K, C, /C)	TKC var	–	0.2	–	0.2	–	0.2	ns	2	
Clock HIGH time (K, /K, C, /C)	TKHKL	1.6	–	2.0	–	2.4	–	ns		
Clock LOW time (K, /K, C, /C)	TKLKH	1.6	–	2.0	–	2.4	–	ns		
Clock to /clock (K→/K., C→/C.)	TKH /KH	1.8	–	2.2	–	2.7	–	ns		
Clock to /clock (/K→K., /C→C.)	T /KHKH	1.8	–	2.2	–	2.7	–	ns		
Clock to data clock (K→C., /K→/C.)	TKHCH	200 to 250 MHz	0	1.8	–	–	–	–	ns	
		167 to 200 MHz	0	2.3	0	2.3	–	–		
		133 to 167 MHz	0	2.8	0	2.8	0	2.8		
		< 133 MHz	0	3.55	0	3.55	0	3.55		
DLL lock time (K, C)	TKC lock	1,024	–	1,024	–	1,024	–	Cycle	3	
K static to DLL reset	TKC reset	30	–	30	–	30	–	ns		
<b>Output Times</b>										
C, /C HIGH to output valid	TCHQV	–	0.45	–	0.45	–	0.5	ns		
C, /C HIGH to output hold	TCHQX	–0.45	–	–0.45	–	–0.5	–	ns		
C, /C HIGH to echo clock valid	TCHCQV	–	0.45	–	0.45	–	0.5	ns		
C, /C HIGH to echo clock hold	TCHCQX	–0.45	–	–0.45	–	–0.5	–	ns		
CQ, /CQ HIGH to output valid	TCQHQV	–	0.3	–	0.35	–	0.4	ns	4	
CQ, /CQ HIGH to output hold	TCQHQX	–0.3	–	–0.35	–	–0.4	–	ns	4	
C HIGH to output High-Z	TCHQZ	–	0.45	–	0.45	–	0.5	ns		
C HIGH to output Low-Z	TCHQX1	–0.45	–	–0.45	–	–0.5	–	ns		
<b>Setup Times</b>										
Address valid to K rising edge	TAVKH	0.5	–	0.6	–	0.7	–	ns	5	
Synchronous load input (/LD), read write input (R, /W) valid to K rising edge	TIVKH	0.5	–	0.6	–	0.7	–	ns	5	
Data inputs and write data select inputs (/BWx, /NWx) valid to K, /K rising edge	TDVKH	0.35	–	0.4	–	0.5	–	ns	5	
<b>Hold Times</b>										
K rising edge to address hold	TKHAX	0.5	–	0.6	–	0.7	–	ns	5	
K rising edge to synchronous load input (/LD), read write input (R, /W) hold	TKHIX	0.5	–	0.6	–	0.7	–	ns	5	
K, /K rising edge to data inputs and write data select inputs (/BWx, /NWx) hold	TKHDX	0.35	–	0.4	–	0.5	–	ns	5	

- Notes**
1. The device will operate at clock frequencies slower than TKHKH(MAX.).
  2. Clock phase jitter is the variance from clock rising edge to the next expected clock rising edge.
  3.  $V_{DD}$  slew rate must be less than 0.1 V DC per 50 ns for DLL lock retention.  
DLL lock time begins once  $V_{DD}$  and input clock are stable.  
It is recommended that the device is kept inactive during these cycles.
  4. Echo clock is very tightly controlled to data valid / data hold. By design, there is a  $\pm 0.1$  ns variation from echo clock to data. The data sheet parameters reflect tester guardbands and test setup variations.
  5. This is a synchronous device. All addresses, data and control lines must meet the specified setup and hold times for all latching clock edges.

- Remarks**
1. This parameter is sampled.
  2. Test conditions as specified with the output loading as shown in AC Test Conditions unless otherwise noted.
  3. Control input signals may not be operated with pulse widths less than TKHKL (MIN.).
  4. If C, /C are tied HIGH, K, /K become the references for C, /C timing parameters.
  5.  $V_{DDQ}$  is 1.5 V DC.

Read and Write Timing

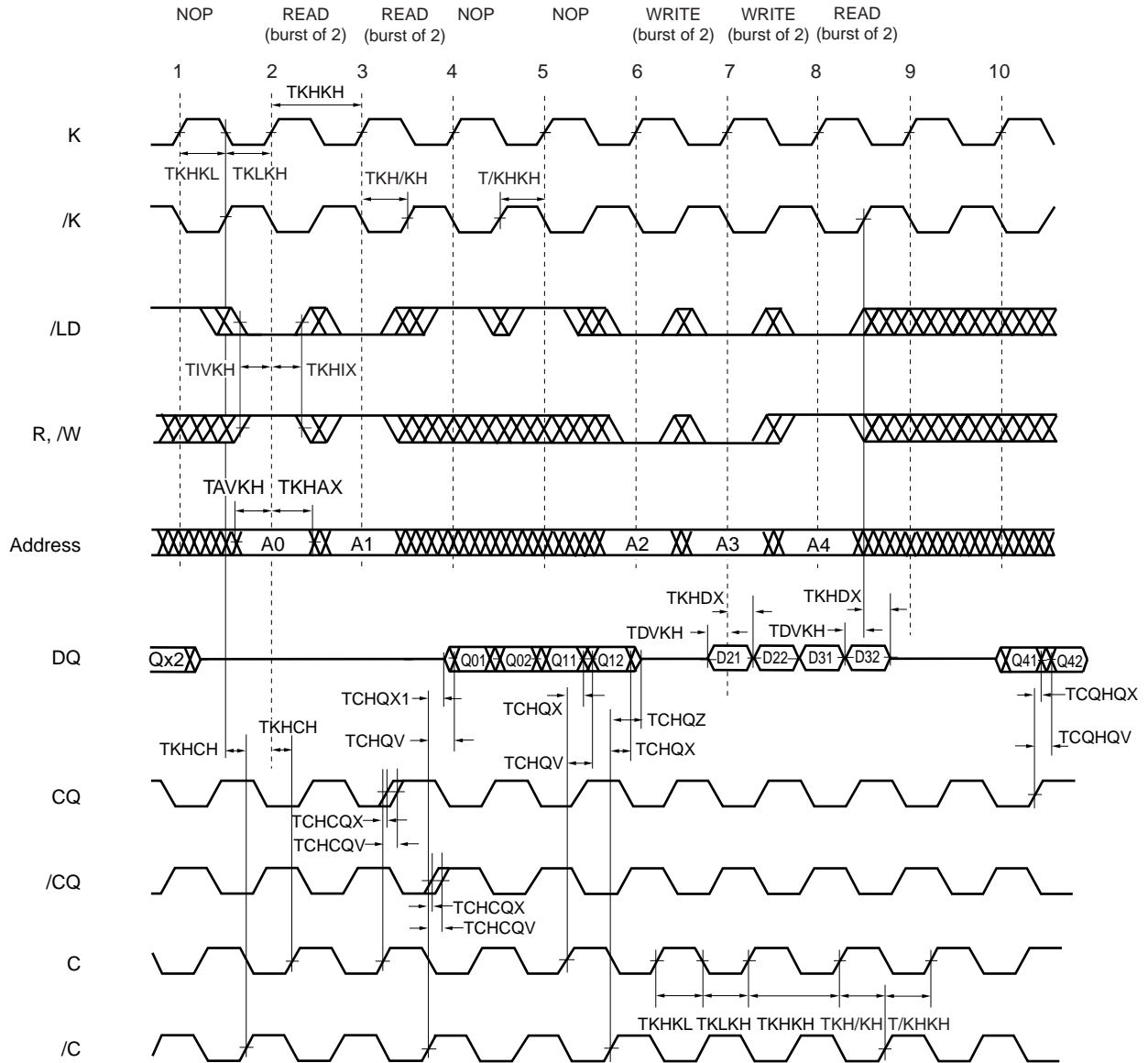

- Remarks**
1. Q01 refers to output from address A0.  
Q02 refers to output from the next internal burst address following A0, etc.
  2. Outputs are disable (high impedance) one clock cycle after a NOP.
  3. The second NOP cycle is not necessary for correct device operation;  
however, at high clock frequencies it may be required to prevent bus contention.



**JTAG Specification**

These products support a limited set of JTAG functions as in IEEE standard 1149.1.

**Test Access Port (TAP) Pins**

Pin name	Pin assignments	Description
TCK	2R	Test Clock Input. All input are captured on the rising edge of TCK and all outputs propagate from the falling edge of TCK.
TMS	10R	Test Mode Select. This is the command input for the TAP controller state machine.
TDI	11R	Test Data Input. This is the input side of the serial registers placed between TDI and TDO. The register placed between TDI and TDO is determined by the state of the TAP controller state machine and the instruction that is currently loaded in the TAP instruction.
TDO	1R	Test Data Output. Output changes in response to the falling edge of TCK. This is the output side of the serial registers placed between TDI and TDO.

**Remark** The device does not have TRST (TAP reset). The Test-Logic Reset state is entered while TMS is held high for five rising edges of TCK. The TAP controller state is also reset on the SRAM POWER-UP.

**JTAG DC Characteristics (T<sub>A</sub> = 0 to 70°C, V<sub>DD</sub> = 1.8 ± 0.1 V, unless otherwise noted)**

Parameter	Symbol	Conditions	MIN.	TYP.	MAX.	Unit	Note
JTAG Input leakage current	I <sub>LI</sub>	0 V ≤ V <sub>IN</sub> ≤ V <sub>DD</sub>	-5.0	-	+5.0	μA	
JTAG I/O leakage current	I <sub>LO</sub>	0 V ≤ V <sub>IN</sub> ≤ V <sub>DDQ</sub> , Outputs disabled	-5.0	-	+5.0	μA	
JTAG input high voltage	V <sub>IH</sub>		1.3	-	V <sub>DD</sub> + 0.3	V	
JTAG input low voltage	V <sub>IL</sub>		-0.3	-	+0.5	V	
JTAG output high voltage	V <sub>OH1</sub>	I <sub>OH</sub> C   = 100 μA	1.6	-	-	V	
	V <sub>OH2</sub>	I <sub>OH</sub> T   = 2 mA	1.4	-	-	V	
JTAG output low voltage	V <sub>OL1</sub>	I <sub>OL</sub> C = 100 μA	-	-	0.2	V	
	V <sub>OL2</sub>	I <sub>OL</sub> T = 2 mA	-	-	0.4	V	

JTAG AC Test Conditions

Input waveform (Rise / Fall time ≤ 1 ns)

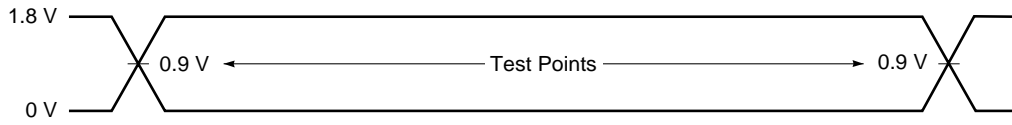

Output waveform

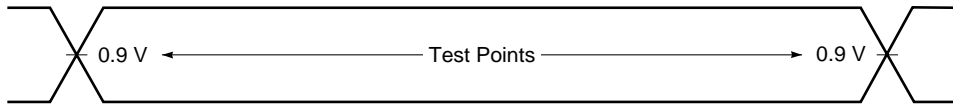

Output load

Figure 2. External load at test

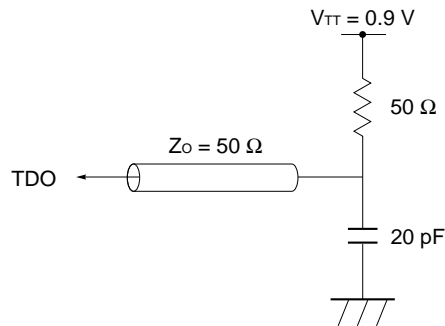

JTAG AC Characteristics (T<sub>A</sub> = 0 to 70 °C)

Parameter	Symbol	Conditions	MIN.	TYP.	MAX.	Unit	Note
<b>Clock</b>							
Clock cycle time	t <sub>THTH</sub>		100	–	–	ns	
Clock frequency	f <sub>TF</sub>		–	–	10	MHz	
Clock high time	t <sub>THTL</sub>		40	–	–	ns	
Clock low time	t <sub>TLTH</sub>		40	–	–	ns	
<b>Output time</b>							
TCK low to TDO unknown	t <sub>TLOX</sub>		0	–	–	ns	
TCK low to TDO valid	t <sub>TLOV</sub>		–	–	20	ns	
TDI valid to TCK high	t <sub>DVTH</sub>		10	–	–	ns	
TCK high to TDI invalid	t <sub>THDX</sub>		10	–	–	ns	
<b>Setup time</b>							
TMS setup time	t <sub>MVTH</sub>		10	–	–	ns	
Capture setup time	t <sub>CS</sub>		10	–	–	ns	
<b>Hold time</b>							
TMS hold time	t <sub>THMX</sub>		10	–	–	ns	
Capture hold time	t <sub>CH</sub>		10	–	–	ns	

JTAG Timing Diagram

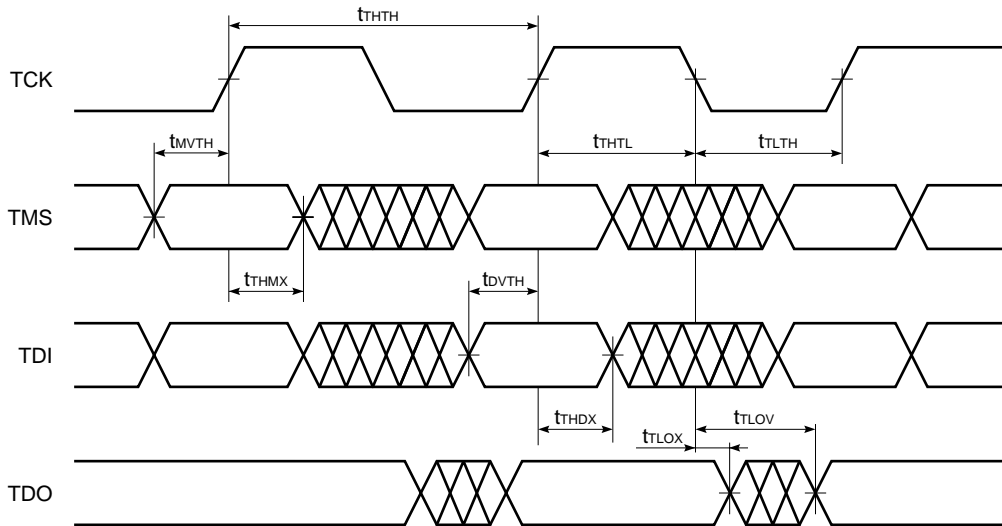

**Scan Register Definition (1)**

Register name	Description
Instruction register	The instruction register holds the instructions that are executed by the TAP controller when it is moved into the run-test/idle or the various data register state. The register can be loaded when it is placed between the TDI and TDO pins. The instruction register is automatically preloaded with the IDCODE instruction at power-up whenever the controller is placed in test-logic-reset state.
Bypass register	The bypass register is a single bit register that can be placed between TDI and TDO. It allows serial test data to be passed through the RAMs TAP to another device in the scan chain with as little delay as possible.
ID register	The ID Register is a 32 bit register that is loaded with a device and vendor specific 32 bit code when the controller is put in capture-DR state with the IDCODE command loaded in the instruction register. The register is then placed between the TDI and TDO pins when the controller is moved into shift-DR state.
Boundary register	The boundary register, under the control of the TAP controller, is loaded with the contents of the RAMs I/O ring when the controller is in capture-DR state and then is placed between the TDI and TDO pins when the controller is moved to shift-DR state. Several TAP instructions can be used to activate the boundary register.  The Scan Exit Order tables describe which device bump connects to each boundary register location. The first column defines the bit's position in the boundary register. The second column is the name of the input or I/O at the bump and the third column is the bump number.

**Scan Register Definition (2)**

Register name	Bit size	Unit
Instruction register	3	bit
Bypass register	1	bit
ID register	32	bit
Boundary register	107	bit

**ID Register Definition**

Part number	Organization	ID [31:28] vendor revision no.	ID [27:12] part no.	ID [11:1] vendor ID no.	ID [0] fix bit
μPD44164082	2M x 8	XXXX	0000 0000 0001 0010	00000010000	1
μPD44164182	1M x 18	XXXX	0000 0000 0001 0011	00000010000	1
μPD44164362	512K x 36	XXXX	0000 0000 0001 0100	00000010000	1

SCAN Exit Order

Bit no.	Signal name			Bump ID
	x8	x18	x36	
1	/C			6R
2	C			6P
3	A			6N
4	A			7P
5	A			7N
6	A			7R
7	A			8R
8	A			8P
9	A			9R
10	NC	DQ0	DQ0	11P
11	NC	NC	DQ9	10P
12	NC	NC	NC	10N
13	NC	NC	NC	9P
14	NC	DQ1	DQ11	10M
15	NC	NC	DQ10	11N
16	NC	NC	NC	9M
17	NC	NC	NC	9N
18	DQ0	DQ2	DQ2	11L
19	NC	NC	DQ1	11M
20	NC	NC	NC	9L
21	NC	NC	NC	10L
22	NC	DQ3	DQ3	11K
23	NC	NC	DQ12	10K
24	NC	NC	NC	9J
25	NC	NC	NC	9K
26	DQ1	DQ4	DQ13	10J
27	NC	NC	DQ4	11J
28	ZQ			11H
29	NC	NC	NC	10G
30	NC	NC	NC	9G
31	NC	DQ5	DQ5	11F
32	NC	NC	DQ14	11G
33	NC	NC	NC	9F
34	NC	NC	NC	10F
35	DQ2	DQ6	DQ6	11E
36	NC	NC	DQ15	10E

Bit no.	Signal name			Bump ID
	x8	x18	x36	
37	NC	NC	NC	10D
38	NC	NC	NC	9E
39	NC	DQ7	DQ17	10C
40	NC	NC	DQ16	11D
41	NC	NC	NC	9C
42	NC	NC	NC	9D
43	DQ3	DQ8	DQ8	11B
44	NC	NC	DQ7	11C
45	NC	NC	NC	9B
46	NC	NC	NC	10B
47	CQ			11A
48	-			Internal
49	A			9A
50	A			8B
51	A			7C
52	A	A0	A0	6C
53	/LD			8A
54	NC	NC	/BW1	7A
55	/NW0	/BW0	/BW0	7B
56	K			6B
57	/K			6A
58	NC	NC	/BW3	5B
59	/NW1	/BW1	/BW2	5A
60	R, /W			4A
61	A			5C
62	A			4B
63	A	A	NC	3A
64	/DLL			1H
65	/CQ			1A
66	NC	DQ9	DQ27	2B
67	NC	NC	DQ18	3B
68	NC	NC	NC	1C
69	NC	NC	NC	1B
70	NC	DQ10	DQ19	3D
71	NC	NC	DQ28	3C
72	NC	NC	NC	1D

Bit no.	Signal name			Bump ID
	x8	x18	x36	
73	NC	NC	NC	2C
74	DQ4	DQ11	DQ20	3E
75	NC	NC	DQ29	2D
76	NC	NC	NC	2E
77	NC	NC	NC	1E
78	NC	DQ12	DQ30	2F
79	NC	NC	DQ21	3F
80	NC	NC	NC	1G
81	NC	NC	NC	1F
82	DQ5	DQ13	DQ22	3G
83	NC	NC	DQ31	2G
84	NC	NC	NC	1J
85	NC	NC	NC	2J
86	NC	DQ14	DQ23	3K
87	NC	NC	DQ32	3J
88	NC	NC	NC	2K
89	NC	NC	NC	1K
90	DQ6	DQ15	DQ33	2L
91	NC	NC	DQ24	3L
92	NC	NC	NC	1M
93	NC	NC	NC	1L
94	NC	DQ16	DQ25	3N
95	NC	NC	DQ34	3M
96	NC	NC	NC	1N
97	NC	NC	NC	2M
98	DQ7	DQ17	DQ26	3P
99	NC	NC	DQ35	2N
100	NC	NC	NC	2P
101	NC	NC	NC	1P
102	A			3R
103	A			4R
104	A			4P
105	A			5P
106	A			5N
107	A			5R

**JTAG Instructions**

Instructions	Description
EXTEST	The EXTEST instruction allows circuitry external to the component package to be tested. Boundary-scan register cells at output pins are used to apply test vectors, while those at input pins capture test results. Typically, the first test vector to be applied using the EXTEST instruction will be shifted into the boundary scan register using the PRELOAD instruction. Thus, during the update-IR state of EXTEST, the output driver is turned on and the PRELOAD data is driven onto the output pins.
IDCODE	The IDCODE instruction causes the ID ROM to be loaded into the ID register when the controller is in capture-DR mode and places the ID register between the TDI and TDO pins in shift-DR mode. The IDCODE instruction is the default instruction loaded in at power up and any time the controller is placed in the test-logic-reset state.
BYPASS	The BYPASS instruction is loaded in the instruction register when the bypass register is placed between TDI and TDO. This occurs when the TAP controller is moved to the shift-DR state. This allows the board level scan path to be shortened to facilitate testing of other devices in the scan path.
SAMPLE / PRELOAD	SAMPLE / PRELOAD is a Standard 1149.1 mandatory public instruction. When the SAMPLE / PRELOAD instruction is loaded in the instruction register, moving the TAP controller into the capture-DR state loads the data in the RAMs input and DQ pins into the boundary scan register. Because the RAM clock(s) are independent from the TAP clock (TCK) it is possible for the TAP to attempt to capture the I/O ring contents while the input buffers are in transition (i.e., in a metastable state). Although allowing the TAP to sample metastable input will not harm the device, repeatable results cannot be expected. RAM input signals must be stabilized for long enough to meet the TAPs input data capture setup plus hold time ( $t_{CS}$ plus $t_{CH}$ ). The RAMs clock inputs need not be paused for any other TAP operation except capturing the I/O ring contents into the boundary scan register. Moving the controller to shift-DR state then places the boundary scan register between the TDI and TDO pins.
SAMPLE-Z	If the SAMPLE-Z instruction is loaded in the instruction register, all RAM DQ pins are forced to an inactive drive state (high impedance) and the boundary register is connected between TDI and TDO when the TAP controller is moved to the shift-DR state.

**JTAG Instruction Coding**

IR2	IR1	IR0	Instruction	Note
0	0	0	EXTEST	
0	0	1	IDCODE	
0	1	0	SAMPLE-Z	1
0	1	1	RESERVED	
1	0	0	SAMPLE / PRELOAD	
1	0	1	RESERVED	
1	1	0	RESERVED	
1	1	1	BYPASS	

**Note 1.** TRISTATE all DQ pins and CAPTURE the pad values into a SERIAL SCAN LATCH.

TAP Controller State Diagram

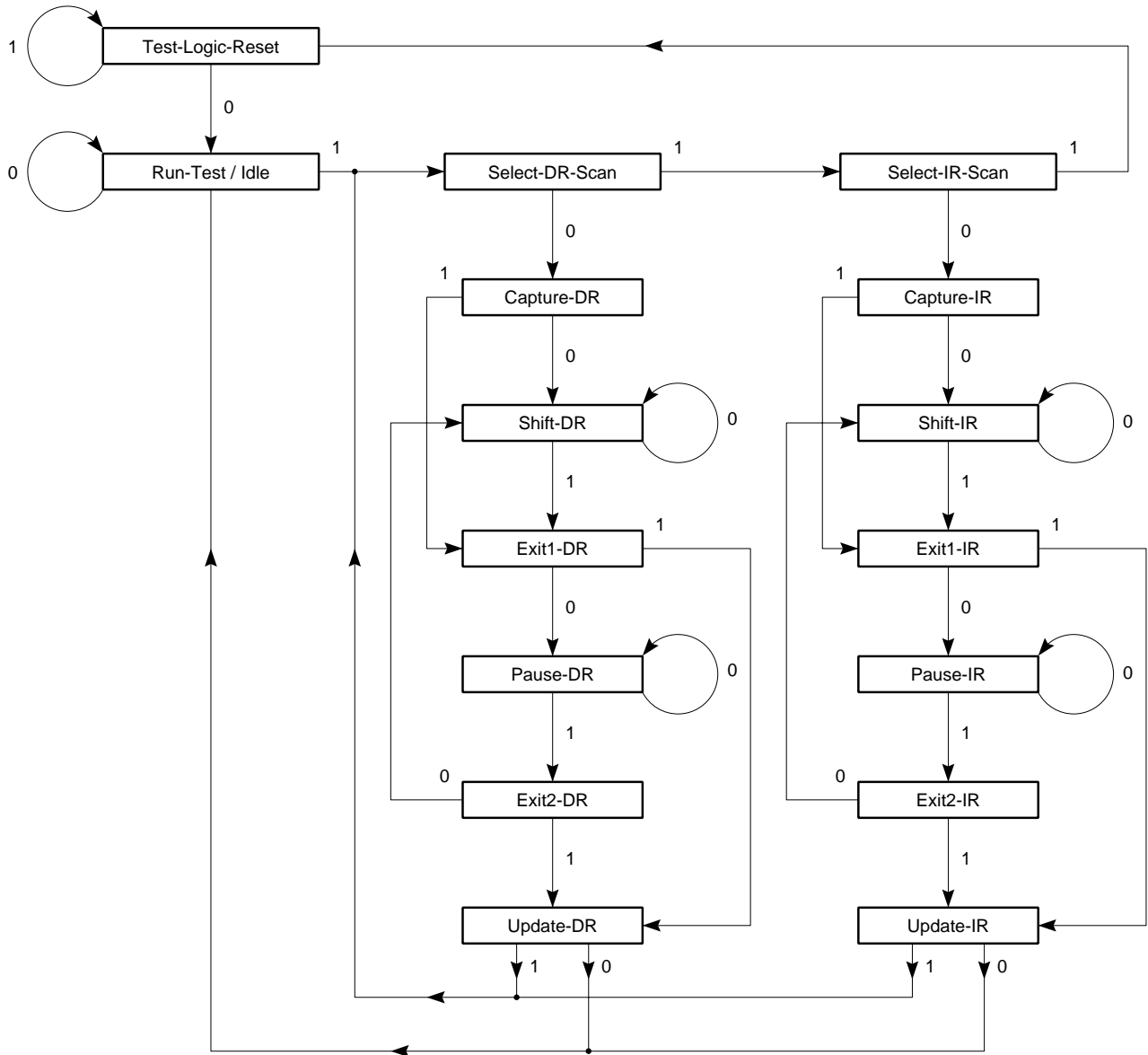

**Disabling the Test Access Port**

It is possible to use this device without utilizing the TAP. To disable the TAP Controller without interfering with normal operation of the device, TCK must be tied to Vss to preclude mid level inputs.

TDI and TMS are designed so an undriven input will produce a response identical to the application of a logic 1, and may be left unconnected. But they may also be tied to VDD through a 1 kΩ resistor.

TDO should be left unconnected.

Test Logic Operation (Instruction Scan)

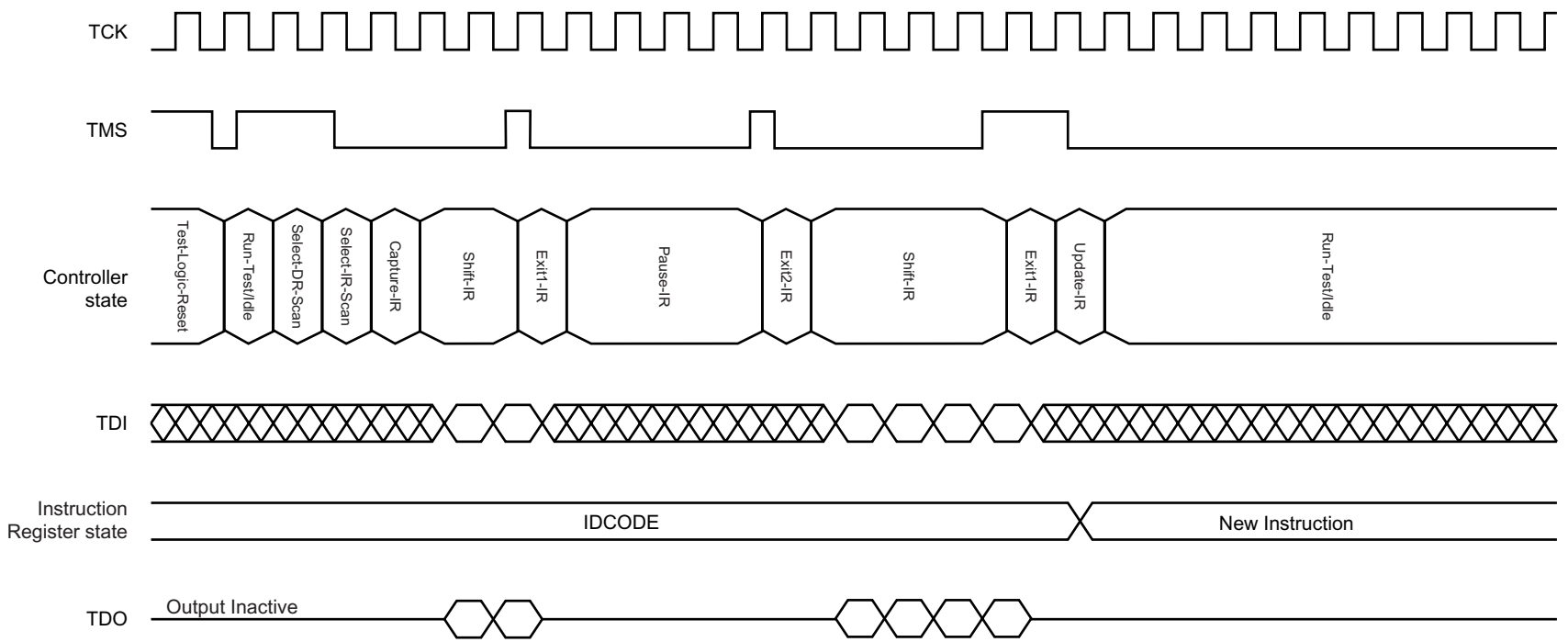



Test Logic (Data Scan)

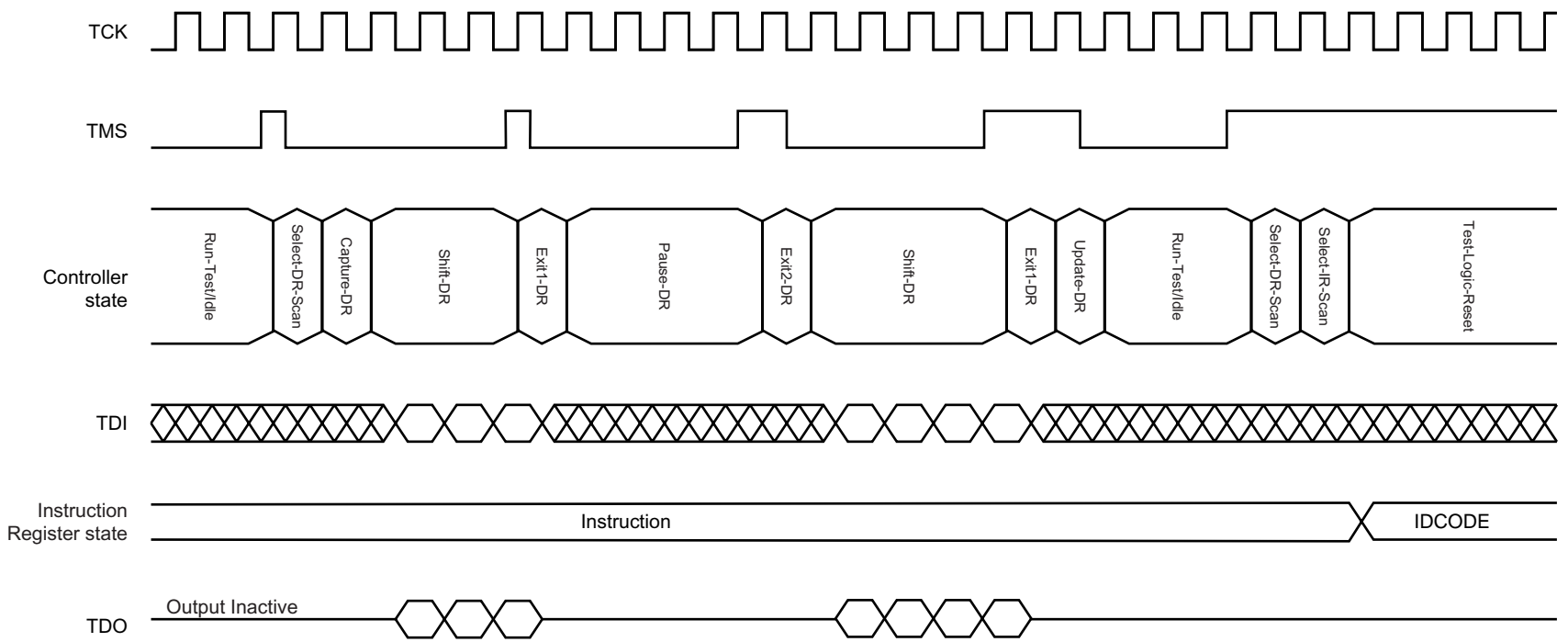

★ Package Drawing

165-PIN PLASTIC BGA (13x15)

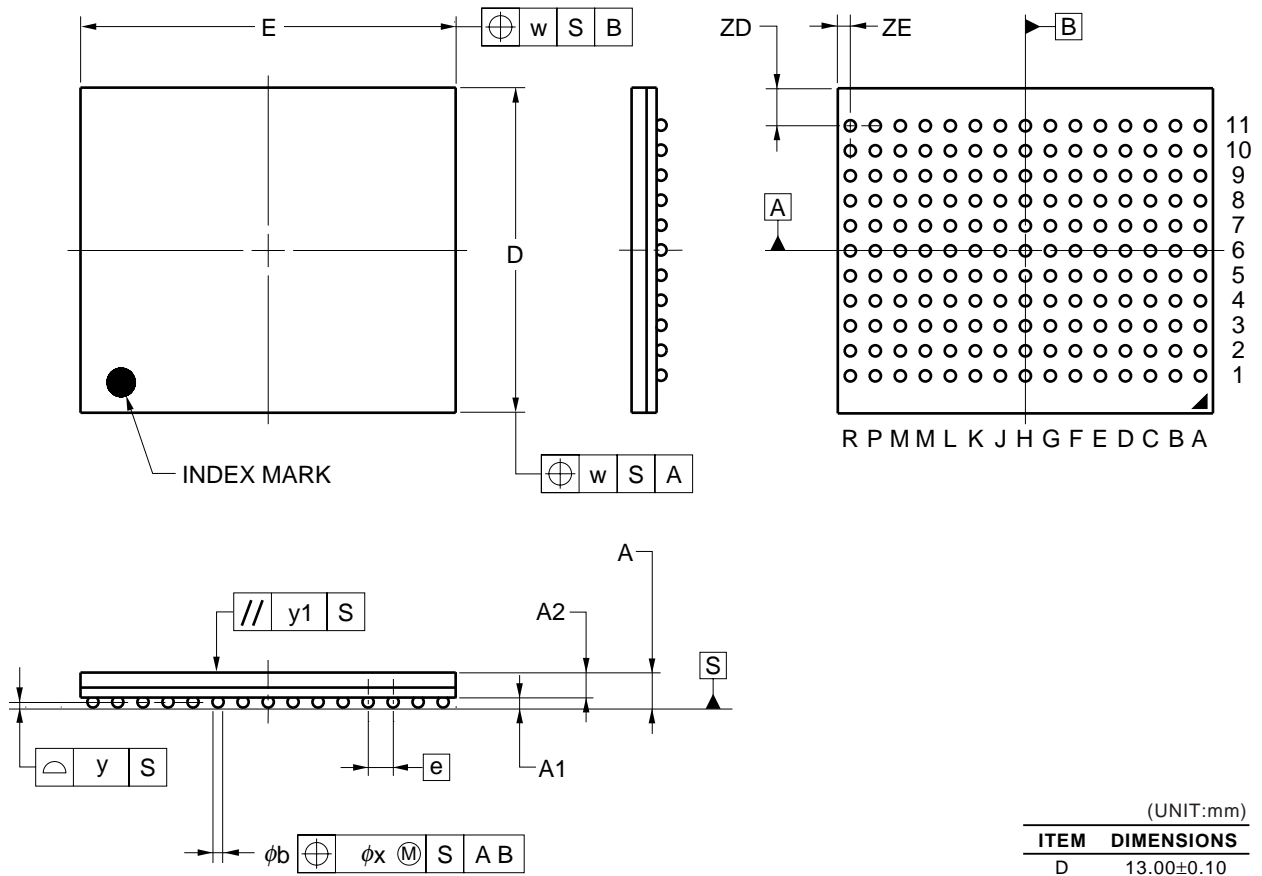

(UNIT:mm)

ITEM	DIMENSIONS
D	13.00±0.10
E	15.00±0.10
w	0.15
e	1.00
A	1.40±0.11
A1	0.40±0.05
A2	1.00
b	0.50±0.05
x	0.08
y	0.10
y1	0.20
ZD	1.50
ZE	0.50

P165F5-100-EQ1

**Recommended Soldering Condition**

Please consult with our sales offices for soldering conditions of these products.

**Types of Surface Mount Devices**

$\mu$ PD44164082F5-EQ1: 165-pin PLASTIC BGA (13 x 15)

$\mu$ PD44164182F5-EQ1: 165-pin PLASTIC BGA (13 x 15)

$\mu$ PD44164362F5-EQ1: 165-pin PLASTIC BGA (13 x 15)

Revision History

Edition/ Date	Page		Type of revision	Location	Description (Previous edition → This edition)																																
	This edition	Previous edition																																			
7th edition/ Feb. 2004	Throughout	Throughout	Deletion	Ordering Information	μPD44164362F5-E40-EQ1																																
	p.12	p.12	Modification	DC Characteristics I <sub>DD</sub> (MAX.)	<table border="1"> <thead> <tr> <th rowspan="2"></th> <th colspan="2">MAX.</th> <th rowspan="2">Unit</th> </tr> <tr> <th>x8, x18</th> <th>x36</th> </tr> </thead> <tbody> <tr> <td>-E40</td> <td>600</td> <td>TBD</td> <td rowspan="3">mA</td> </tr> <tr> <td>-E50</td> <td>500</td> <td>600</td> </tr> <tr> <td>-E60</td> <td>430</td> <td>520</td> </tr> </tbody> </table> <span style="font-size: 2em; vertical-align: middle;">→</span> <table border="1"> <thead> <tr> <th rowspan="2"></th> <th colspan="2">MAX.</th> <th rowspan="2">Unit</th> </tr> <tr> <th>x8, x18</th> <th>x36</th> </tr> </thead> <tbody> <tr> <td>-E40</td> <td>650</td> <td>-</td> <td rowspan="3">mA</td> </tr> <tr> <td>-E50</td> <td>550</td> <td>650</td> </tr> <tr> <td>-E60</td> <td>480</td> <td>570</td> </tr> </tbody> </table>		MAX.		Unit	x8, x18	x36	-E40	600	TBD	mA	-E50	500	600	-E60	430	520		MAX.		Unit	x8, x18	x36	-E40	650	-	mA	-E50	550	650	-E60	480	570
	MAX.		Unit																																		
	x8, x18	x36																																			
-E40	600	TBD	mA																																		
-E50	500	600																																			
-E60	430	520																																			
	MAX.		Unit																																		
	x8, x18	x36																																			
-E40	650	-	mA																																		
-E50	550	650																																			
-E60	480	570																																			
				DC Characteristics I <sub>SB1</sub> (MAX.)	<table border="1"> <thead> <tr> <th rowspan="2"></th> <th colspan="2">MAX.</th> <th rowspan="2">Unit</th> </tr> <tr> <th>x8, x18</th> <th>x36</th> </tr> </thead> <tbody> <tr> <td>-E40</td> <td colspan="2">250</td> <td rowspan="3">mA</td> </tr> <tr> <td>-E50</td> <td colspan="2">210</td> </tr> <tr> <td>-E60</td> <td colspan="2">190</td> </tr> </tbody> </table> <span style="font-size: 2em; vertical-align: middle;">→</span> <table border="1"> <thead> <tr> <th rowspan="2"></th> <th colspan="2">MAX.</th> <th rowspan="2">Unit</th> </tr> <tr> <th>x8, x18</th> <th>x36</th> </tr> </thead> <tbody> <tr> <td>-E40</td> <td>320</td> <td>-</td> <td rowspan="3">mA</td> </tr> <tr> <td>-E50</td> <td colspan="2">270</td> </tr> <tr> <td>-E60</td> <td colspan="2">250</td> </tr> </tbody> </table>		MAX.		Unit	x8, x18	x36	-E40	250		mA	-E50	210		-E60	190			MAX.		Unit	x8, x18	x36	-E40	320	-	mA	-E50	270		-E60	250	
	MAX.		Unit																																		
	x8, x18	x36																																			
-E40	250		mA																																		
-E50	210																																				
-E60	190																																				
	MAX.		Unit																																		
	x8, x18	x36																																			
-E40	320	-	mA																																		
-E50	270																																				
-E60	250																																				
	p.26	p.26	Modification	Package Drawing	Preliminary version → Standardized version																																

[MEMO]

[MEMO]

## NOTES FOR CMOS DEVICES

**① VOLTAGE APPLICATION WAVEFORM AT INPUT PIN**

Waveform distortion due to input noise or a reflected wave may cause malfunction. If the input of the CMOS device stays in the area between  $V_{IL}$  (MAX) and  $V_{IH}$  (MIN) due to noise, etc., the device may malfunction. Take care to prevent chattering noise from entering the device when the input level is fixed, and also in the transition period when the input level passes through the area between  $V_{IL}$  (MAX) and  $V_{IH}$  (MIN).

**② HANDLING OF UNUSED INPUT PINS**

Unconnected CMOS device inputs can be cause of malfunction. If an input pin is unconnected, it is possible that an internal input level may be generated due to noise, etc., causing malfunction. CMOS devices behave differently than Bipolar or NMOS devices. Input levels of CMOS devices must be fixed high or low by using pull-up or pull-down circuitry. Each unused pin should be connected to  $V_{DD}$  or GND via a resistor if there is a possibility that it will be an output pin. All handling related to unused pins must be judged separately for each device and according to related specifications governing the device.

**③ PRECAUTION AGAINST ESD**

A strong electric field, when exposed to a MOS device, can cause destruction of the gate oxide and ultimately degrade the device operation. Steps must be taken to stop generation of static electricity as much as possible, and quickly dissipate it when it has occurred. Environmental control must be adequate. When it is dry, a humidifier should be used. It is recommended to avoid using insulators that easily build up static electricity. Semiconductor devices must be stored and transported in an anti-static container, static shielding bag or conductive material. All test and measurement tools including work benches and floors should be grounded. The operator should be grounded using a wrist strap. Semiconductor devices must not be touched with bare hands. Similar precautions need to be taken for PW boards with mounted semiconductor devices.

**④ STATUS BEFORE INITIALIZATION**

Power-on does not necessarily define the initial status of a MOS device. Immediately after the power source is turned ON, devices with reset functions have not yet been initialized. Hence, power-on does not guarantee output pin levels, I/O settings or contents of registers. A device is not initialized until the reset signal is received. A reset operation must be executed immediately after power-on for devices with reset functions.

**⑤ POWER ON/OFF SEQUENCE**

In the case of a device that uses different power supplies for the internal operation and external interface, as a rule, switch on the external power supply after switching on the internal power supply. When switching the power supply off, as a rule, switch off the external power supply and then the internal power supply. Use of the reverse power on/off sequences may result in the application of an overvoltage to the internal elements of the device, causing malfunction and degradation of internal elements due to the passage of an abnormal current.

The correct power on/off sequence must be judged separately for each device and according to related specifications governing the device.

**⑥ INPUT OF SIGNAL DURING POWER OFF STATE**

Do not input signals or an I/O pull-up power supply while the device is not powered. The current injection that results from input of such a signal or I/O pull-up power supply may cause malfunction and the abnormal current that passes in the device at this time may cause degradation of internal elements. Input of signals during the power off state must be judged separately for each device and according to related specifications governing the device.

- **The information in this document is current as of August, 2004. The information is subject to change without notice. For actual design-in, refer to the latest publications of NEC Electronics data sheets or data books, etc., for the most up-to-date specifications of NEC Electronics products. Not all products and/or types are available in every country. Please check with an NEC Electronics sales representative for availability and additional information.**
- No part of this document may be copied or reproduced in any form or by any means without the prior written consent of NEC Electronics. NEC Electronics assumes no responsibility for any errors that may appear in this document.
- NEC Electronics does not assume any liability for infringement of patents, copyrights or other intellectual property rights of third parties by or arising from the use of NEC Electronics products listed in this document or any other liability arising from the use of such products. No license, express, implied or otherwise, is granted under any patents, copyrights or other intellectual property rights of NEC Electronics or others.
- Descriptions of circuits, software and other related information in this document are provided for illustrative purposes in semiconductor product operation and application examples. The incorporation of these circuits, software and information in the design of a customer's equipment shall be done under the full responsibility of the customer. NEC Electronics assumes no responsibility for any losses incurred by customers or third parties arising from the use of these circuits, software and information.
- While NEC Electronics endeavors to enhance the quality, reliability and safety of NEC Electronics products, customers agree and acknowledge that the possibility of defects thereof cannot be eliminated entirely. To minimize risks of damage to property or injury (including death) to persons arising from defects in NEC Electronics products, customers must incorporate sufficient safety measures in their design, such as redundancy, fire-containment and anti-failure features.
- NEC Electronics products are classified into the following three quality grades: "Standard", "Special" and "Specific".  
The "Specific" quality grade applies only to NEC Electronics products developed based on a customer-designated "quality assurance program" for a specific application. The recommended applications of an NEC Electronics product depend on its quality grade, as indicated below. Customers must check the quality grade of each NEC Electronics product before using it in a particular application.  
"Standard": Computers, office equipment, communications equipment, test and measurement equipment, audio and visual equipment, home electronic appliances, machine tools, personal electronic equipment and industrial robots.  
"Special": Transportation equipment (automobiles, trains, ships, etc.), traffic control systems, anti-disaster systems, anti-crime systems, safety equipment and medical equipment (not specifically designed for life support).  
"Specific": Aircraft, aerospace equipment, submersible repeaters, nuclear reactor control systems, life support systems and medical equipment for life support, etc.

The quality grade of NEC Electronics products is "Standard" unless otherwise expressly specified in NEC Electronics data sheets or data books, etc. If customers wish to use NEC Electronics products in applications not intended by NEC Electronics, they must contact an NEC Electronics sales representative in advance to determine NEC Electronics' willingness to support a given application.

(Note)

- (1) "NEC Electronics" as used in this statement means NEC Electronics Corporation and also includes its majority-owned subsidiaries.
- (2) "NEC Electronics products" means any product developed or manufactured by or for NEC Electronics (as defined above).