

5. ELECTRIC CHARACTERISTICS

Absolute maximum ratings ($T_a=25^\circ\text{C}$)

Parameter	Symbol	Test condition	Ratings	Units
Power supply voltage	V_{DD}		-0.5 to +7.0	V
	AV_{REF}		-0.5 to $V_{DD}+0.5$	V
	AV_{SS}		-0.5 to +0.5	V
Input voltage	V_{I1}		-0.5 to $V_{DD}+0.5$	V
	V_{I2}	(Note)	-0.5 to $AV_{REF}+0.5$	V
Output voltage	V_O		-0.5 to $V_{DD}+0.5$	V
Output low current	I_{OL}	Per pin	15	mA
		Total, all outputs	100	mA
Output high current	I_{OH}	Per pin	-10	mA
		Total, all outputs	-50	mA
Operation temperature	T_{opt}		-10 to +70	$^\circ\text{C}$
Storage temperature	T_{stg}		-65 to +150	$^\circ\text{C}$

Note: Pins of P70/ANI0-P75/ANI5, P66/ $\overline{\text{WAIT}}$ /ANI6, and P67/ $\overline{\text{REFRQ}}$ /ANI7 are used as A/D converter input pins. However, the absolute maximum rating of V_{I1} must also be satisfied.

Caution: If even one parameter exceeds the absolute maximum rating, even instantaneously, the quality of the product may be damaged. The absolute maximum rating is a rated threshold value at which the product can be physically damaged. Be sure to use the product within the absolute maximum ratings.

Operation conditions

Clock frequency	Operation temperature (T_{opt})	Power supply voltage (V_{DD})
$4\text{MHz} \leq f_{XX} \leq 12\text{MHz}$	-10 to +70 $^\circ\text{C}$	+5V \pm 10%

Capacitance ($T_a=25^\circ\text{C}$, $V_{DD}=V_{SS}=0\text{ V}$)

Parameter	Symbol	Test condition	MIN.	TYP.	MAX.	Units
Input capacitance	C_I	$f=1\text{MHz}$ Unmeasured pins returned to 0 V			20	pF
Output capacitance	C_O				20	pF
Input/output capacitance	C_{IO}				20	pF

Oscillator Characteristics ($T_a=-40\text{ to }+85^\circ\text{C}$, $V_{DD}=+5\text{V}\pm 10\%$, $V_{SS}=0\text{V}$)

Resonator	Recommended constants	Item	MIN.	MAX.	Units
Ceramic oscillator or cristal resonator		Oscillation frequency (f_{xx})	4	12	MHz
External clock		X1 input frequency (f_x)	4	12	MHz
		X1 input rise time/fall time (t_{XR} , t_{XF})	0	30	ns
		X1 input high/low level width (t_{WXH} , t_{WXL})	30	130	ns

Caution: To use the clock oscillator, wire the portions surrounded by [] to avoid wiring capacitance affection, etc., as follows:

- Make wiring as extremely short as possible.
- Do not cross the oscillator and any other signal line over each other.
- Do not put the oscillator near any line where high current fluctuates.
- Be sure to place oscillator capacitor ground point in the same potential as the V_{SS} pin.
Do not connect to any ground pattern where high current flows.
- Do not take out any signal from the oscillator.

Recommended oscillator constants

Ceramic oscillator

Manufacturer	Frequency [MHz]	Product name	Recommended constants	
			C1[pF]	C2[pF]
MURATA	12	CSA12.OMTZ	30	30
		CST12.OMTW	Contained a condenser	

DC characteristics (Ta=-10°C to +70°C, V_{DD}=+5V±10%, V_{SS}=0 V)

Parameter	Symbol	Test condition	MIN.	TYP.	MAX.	Units	
Input low voltage	V _{IL}		0		0.8	V	
Input high voltage	V _{IH1}	Pins except for listed in Note 1 or 2	2.2		V _{DD}	V	
	V _{IH2}	Pins listed in Note 1	2.2		A _{VREF}	V	
	V _{IH3}	Pins listed in Note 2	0.8V _{DD}		V _{DD}	V	
Output low voltage	V _{OL1}	I _{OL} =2.0mA			0.45	V	
	V _{OL2}	I _{OL} =8.0mA (Note 3)			1.0	V	
Output high voltage	V _{OH1}	I _{OH} =-1.0mA	V _{DD} -1.0			V	
	V _{OH2}	I _{OH} =-100uA	V _{DD} -0.5			V	
	V _{OH3}	I _{OH} =-5.0mA (Note 4)	2.0			V	
X1 input low current	I _{IL}	0 ≤ V _I ≤ V _{IL}			-100	uA	
X1 input high current	I _{IH}	V _{IH3} ≤ V _I ≤ V _{DD}			100	uA	
Input leakage current	I _{LI}	0V ≤ V _I ≤ V _{DD}			±10	uA	
Output leakage current	I _{LO}	0 V ≤ V _O ≤ V _{DD}			±10	uA	
A _{VREF} current	A _{IREF}	Operation mode f _{xx} =12MHz		1.5	5.0	mA	
V _{DD} supply current power	I _{DD1}	Operation mode f _{xx} =12MHz		20	40	mA	
	I _{DD2}	HALT mode f _{xx} =12MHz		7	20	mA	
Data retention voltage	V _{DDDR}	STOP mode	2.5		5.5	V	
Data retention current	I _{DDDR}	STOP mode	V _{DDDR} =2.5V		2	20	uA
			V _{DDDR} =5V±10%		5	50	uA
Pull-up resistor	R _L	V _I =0 V	15	40	80	kΩ	
EEPROM write voltage		4MHz ≤ f _{xx} ≤ 12MHz	4.5		5.5	V	

Notes 1: Pins of P70/ANI0-P75/ANI5, P66/WAIT/ANI6, and P67/REFRQ/ANI7 except are used as A/D converter input pins.

2: X1, X2, RESET, P20/NMI, P21/INTP0, P22/INTP1, P23/INTP2/CI, P24/INTP3, P25/INTP4/ASCK, P26/INTP5, P27/SI, P32/SCK, P33/SO/SB0, and EA pins.

3: P40/AD0-P47/AD7 and P50/A8-P57/A15 pins.

4: P00-P07 pins.

AC characteristics ($T_a = -10^\circ\text{C}$ to $+70^\circ\text{C}$, $V_{DD} = +5\text{V} \pm 10\%$, $V_{SS} = 0\text{ V}$)

Read/write operation (1/2)

Parameter	Symbol	Test condition	MIN.	MAX.	Units
X1 input clock cycle time	t_{CYX}		82	250	ns
Address setup time to $\overline{\text{ASTB}}$ ↓	t_{SAST}^*		52		ns
Address hold time from $\overline{\text{ASTB}}$ ↓ (Note)	t_{HSTA}		25		ns
Address hold time from $\overline{\text{RD}}$ ↓	t_{HRA}		30		ns
Address hold time from $\overline{\text{WR}}$ ↓	t_{HWA}		30		ns
Address → $\overline{\text{RD}}$ ↓ delay time	t_{DAR}^*		129		ns
Address float time $\overline{\text{RD}}$ ↓	t_{FAR}^*		11		ns
Address → data input time	t_{DAID}^*	Wait count=0		228	ns
$\overline{\text{ASTB}}$ ↓ → data input time	t_{DSTID}^*	Wait count=0		181	ns
$\overline{\text{RD}}$ ↓ → data input time	t_{DRID}^*	Wait count=0		100	ns
$\overline{\text{ASTB}}$ ↓ → $\overline{\text{RD}}$ ↓ delay time	t_{DSTR}^*		52		ns
Data hold time from $\overline{\text{RD}}$ ↓	t_{HRID}		0		ns
$\overline{\text{RD}}$ ↓ → address active time	t_{DRA}^*		124		ns
$\overline{\text{RD}}$ ↓ → $\overline{\text{ASTB}}$ ↓ delay time	t_{DRST}^*		124		ns
$\overline{\text{RD}}$ low level width	t_{WRL}^*	Wait count=0	124		ns
$\overline{\text{ASTB}}$ high level width	t_{WSTH}^*		52		ns
Address → $\overline{\text{WR}}$ ↓ delay time	t_{DAW}^*		129		ns
$\overline{\text{ASTB}}$ ↓ → data output time	t_{DSTOD}^*			142	ns
$\overline{\text{WR}}$ ↓ → data output time	t_{DWOD}			60	ns
$\overline{\text{ASTB}}$ ↓ → $\overline{\text{WR}}$ ↓ delay time	t_{DSTW1}^*	When refresh is disabled.	52		ns
	t_{DSTW2}^*	When refresh is enabled.	129		ns
Data setup time to $\overline{\text{WR}}$ ↓	t_{SODWR}^*	Wait count=0	146		ns
Data setup time to $\overline{\text{WR}}$ ↓	t_{SODWF}^*	When refresh is enabled.	22		ns
Data hold time from $\overline{\text{WR}}$ ↓ (Note)	t_{HWOD}		20		ns
$\overline{\text{WR}}$ ↓ → $\overline{\text{ASTB}}$ ↓ delay time	t_{DWST}^*		42		ns
$\overline{\text{WR}}$ low level width	t_{WWL1}^*	Wait count=0 when refresh is disabled.	196		ns
	t_{WWL2}^*	Wait count=0 when refresh is enabled.	114		ns
Address → $\overline{\text{WAIT}}$ ↓ input time	t_{DAWT}^*			146	ns
$\overline{\text{ASTB}}$ ↓ → $\overline{\text{WAIT}}$ ↓ input time	t_{DSTWT}^*			84	ns

Note: The hold time contains the V_{OH} , V_{OL} holding time under the load conditions of $C_L = 100\text{ pF}$ and $R_L = 2\text{ k}\Omega$.

Remarks 1: The numeric values listed in the table are values when $f_{XX} = 12\text{ MHz}$ and $C_L = 100\text{ pF}$.

2: For the parameters with an asterisk under Symbol, also see T_{CYX} -dependent Bus Timing Definition.

Read/write operation (2/2)

Parameter	Symbol	Test condition	MIN.	MAX.	Units
$\overline{\text{ASTB}} \downarrow \rightarrow \overline{\text{WAIT}}$ retention time	t_{BSTWT}^*	External wait count=1	174		ns
$\overline{\text{ASTB}} \downarrow \rightarrow \overline{\text{WAIT}} \uparrow$ delay time	t_{DSTWTE}^*	External wait count=1		273	ns
$\overline{\text{RD}} \downarrow \rightarrow \overline{\text{WAIT}} \downarrow$ input time	t_{DRWTL}^*			22	ns
$\overline{\text{RD}} \downarrow \rightarrow \overline{\text{WAIT}}$ retention time	t_{HRWT}^*	External wait count=1	87		ns
$\overline{\text{RD}} \downarrow \rightarrow \overline{\text{WAIT}} \uparrow$ delay time	t_{DRWTE}^*	External wait count=1		186	ns
$\overline{\text{WAIT}} \uparrow \rightarrow$ data input time	t_{DWTID}^*			62	ns
$\overline{\text{WAIT}} \uparrow \rightarrow \overline{\text{WR}} \uparrow$ delay time	t_{DWTW}^*		154		ns
$\overline{\text{WAIT}} \uparrow \rightarrow \overline{\text{RD}} \uparrow$ delay time	t_{DWTIR}^*		72		ns
$\overline{\text{WR}} \downarrow \rightarrow \overline{\text{WAIT}} \downarrow$ input time (when refresh is disabled)	t_{DWWTL}^*			22	ns
$\overline{\text{WR}} \downarrow \rightarrow$ $\overline{\text{WAIT}}$ retention time	When refresh is disabled	t_{HWT1}^*	External wait count=1	87	ns
	When refresh is enabled	t_{HWT2}^*	External wait count=1	5	ns
$\overline{\text{WR}} \downarrow \rightarrow$ $\overline{\text{WAIT}} \uparrow$ delay time	When refresh is disabled	t_{DWWTE1}^*	External wait count=1		186
	When refresh is enabled	t_{DWWTE2}^*	External wait count=1		104
$\overline{\text{RD}} \uparrow \rightarrow \overline{\text{REFRQ}} \downarrow$ delay time	t_{DRRFQ}^*		154		ns
$\overline{\text{WR}} \uparrow \rightarrow \overline{\text{REFRQ}} \downarrow$ delay time	t_{DWRFQ}^*		72		ns
$\overline{\text{REFRQ}}$ low level width	t_{WRFQL}^*		120		ns
$\overline{\text{REFRQ}} \uparrow \rightarrow \overline{\text{ASTB}} \uparrow$ delay time	t_{DRFQST}^*		280		ns

Remarks 1: The numeric values in the table apply when $f_{\text{XX}}=12$ MHz and $C_L=100$ pF.

2: For the parameters with an asterisk under the Symbol, also see t_{CYX} -dependent Bus Timing Definition.

Serial operation

Parameter	Symbol	Test condition	MIN.	MAX.	Units	
Serial clock cycle time	t_{CYSK}	Input External clock	1.0		us	
		Output	Internal divide by 16	1.3		us
			Internal divide by 64	5.3		us
Serial clock low level width	t_{WSKL}	Input External clock	420		ns	
		Output	Internal divide by 16	556		ns
			Internal divide by 64	2.5		us
Serial clock high level width	t_{WSKH}	Input External clock	420		ns	
		Output	Internal divide by 16	556		ns
			Internal divide by 64	2.5		us
SI, SBO setup time to $\overline{SCK} \downarrow$	t_{SSSK}		150		ns	
SI, SBO hold time from $\overline{SCK} \downarrow$	t_{HSSK}		400		ns	
SO/SBO output delay time from $\overline{SCK} \downarrow$	t_{DSBSK1}	CMOS push-pull output (3-line serial I/O mode)	0	300	ns	
	t_{DSBSK2}	Open drain output (SBI mode), $R_L=1k\Omega$	0	800	ns	
SBO high hold time from $\overline{SCK} \downarrow$	t_{HSBSK}	SBI mode	4		t_{CYX}	
SBO low setup time to $\overline{SCK} \downarrow$	t_{SSBSK}		4		t_{CYX}	
SBO low level width	t_{WSBL}		4		t_{CYX}	
SBO high level width	t_{WSBH}		4		t_{CYX}	

Remarks: The numeric values listed in the table are values when $f_{XX}=12$ MHz and $C_L=100$ pF.

Other operations

Parameter	Symbol	Test condition	MIN.	MAX.	Units
NMI low level width	t_{WNIL}		10		us
NMI high level width	t_{WNIH}		10		us
INTP0-INTP5 low level width	t_{WITL}		24		t_{CYX}
INTP0-INTP5 high level width	t_{WITH}		24		t_{CYX}
$\overline{\text{RESET}}$ low level width	t_{WRSL}		10		us
$\overline{\text{RESET}}$ high level width	t_{WRSH}		10		us

External clock timing

Parameter	Symbol	Test condition	MIN.	MAX.	Units
X1 input low level width	t_{WXL}		30	130	ns
X1 input high level width	t_{WXH}		30	130	ns
X1 input rise time	t_{XR}		0	30	ns
X1 input fall time	t_{XF}		0	30	ns
X1 input clock cycle time	t_{CYX}		82	250	ns

A/D converter characteristics (Ta=-10°C to +70°C, V_{DD}=+5V±10%,
V_{SS}=AV_{SS}=0 V)

Parameter	Symbol	Test condition	MIN.	TYP.	MAX.	Units
Resolution			8			bit
(Note 1) Total error		4.0V±AV _{REF} ≤V _{DD}			0.4	%
		3.6V±AV _{REF} ≤V _{DD}			0.8	%
Quantization error					±1/2	LSB
Conversion time	t _{CONV}	82ns≤t _{CYX} <125ns When ADM FR bit is 0	360			t _{CYX}
		125ns≤t _{CYX} <250ns When ADM FR bit is 1	240			t _{CYX}
Sampling time	t _{SAMP}	82ns≤t _{CYX} <125ns When ADM FR bit is 0	72			t _{CYX}
		125ns≤t _{CYX} <250ns When ADM FR bit is 1	48			t _{CYX}
Analog input voltage	V _{IAN}		-0.3		AV _{REF} +0.3	V
Analog input impedance	R _{AN}			1000		MΩ
Reference voltage	AV _{REF}		3.6		V _{DD}	V
AV _{REF} current	AI _{REF}	f _{xx} =12MHz		1.5	5.0	mA
		(Note 2)		0.2	1.5	mA

Notes 1: It does not contain a quantization error. It is represented by a ratio to the full scale value.

2: When the ADM register CS bit is 0.

t_{CYX} -dependent bus timing definition (1/2)

Parameter	Symbol	Test condition	MIN./MAX.	12MHz	Units
X1 input clock cycle time	t_{CYX}		MIN	82	ns
Address setup time to $ASTB\downarrow$	t_{SAST}	$t_{CYX}-30$	MIN.	52	ns
Address hold time from $RD\downarrow$	t_{HRA}		MIN.	30	ns
Address hold time from $WR\downarrow$	t_{HWA}		MIN.	30	ns
Address $\rightarrow RD\downarrow$ delay time	t_{DAR}	$2t_{CYX}-35$	MIN.	129	ns
Address float time to $RD\downarrow$	t_{FAR}	$t_{CYX}/2-30$	MIN.	11	ns
Address \rightarrow data input time	t_{DAID}	$(4+2n)t_{CYX}-100$	MAX.	228 (Note)	ns
$ASTB\downarrow \rightarrow$ data input time	t_{DSTID}	$(3+2n)t_{CYX}-65$	MAX.	181 (Note)	ns
$RD\downarrow \rightarrow$ data input time	t_{DRID}	$(2+2n)t_{CYX}-64$	MAX.	100 (Note)	ns
$ASTB\downarrow \rightarrow RD\downarrow$ delay time	t_{DSTR}	$t_{CYX}-30$	MIN.	52	ns
$RD \rightarrow$ address active time	t_{DRA}	$2t_{CYX}-40$	MIN.	124	ns
$RD\downarrow \rightarrow ASTB\downarrow$ delay time	t_{DRST}	$2t_{CYX}-40$	MIN.	124	ns
RD low level width	t_{WRL}	$(2+2n)t_{CYX}-40$	MIN.	124 (Note)	ns
$ASTB$ high level width	t_{WSTH}	$t_{CYX}-30$	MIN.	52	ns
Address $\rightarrow WR\downarrow$ delay time	t_{DAW}	$2t_{CYX}-35$	MIN.	129	ns
$ASTB\downarrow \rightarrow$ data output time	t_{DSTOD}	$t_{CYX}+60$	MAX.	142	ns
$ASTB\downarrow \rightarrow WR\downarrow$ delay time	t_{DSTW1}	$t_{CYX}-30$ (When refresh is disabled.)	MIN.	52	ns
	t_{DSTW2}	$2t_{CYX}-35$ (When refresh is enabled.)	MIN.	129	ns
Data setup time to $WR\downarrow$	t_{SODWR}	$(3+2n)t_{CYX}-100$	MIN.	146 (Note)	ns
Data setup time to $WR\downarrow$	t_{SODWF}	$t_{CYX}-60$ (When refresh is enabled.)	MIN.	22	ns
$WR\downarrow \rightarrow ASTB\downarrow$ delay time	t_{DWST}	$t_{CYX}-40$	MIN.	42	ns
WR low level width	t_{WWL1}	$(3+2n)t_{CYX}-50$ (When refresh is disabled.)	MIN.	196 (Note)	ns
	t_{WWL2}	$(2+2n)t_{CYX}-50$ (When refresh is enabled.)	MIN.	114 (Note)	ns
Address $\rightarrow WAIT\downarrow$ input time	t_{DAWT}	$3t_{CYX}-100$	MAX.	146	ns
$ASTB\downarrow \rightarrow WAIT\downarrow$ input time	t_{DSTWT}	$2t_{CYX}-80$	MAX.	84	ns

Remarks: n denotes the number of wait states.

Note: When n=0.

t_{CYX} -dependent bus timing definition (2/2)

Parameter	Symbol	Test condition	MIN./MAX.	12MHz	Units
$\overline{ASTB} \downarrow \rightarrow \overline{WAIT}$ retention time	t_{HSTWT}	$2Xt_{CYX}+10$	MIN.	174 (Note)	ns
$\overline{ASTB} \downarrow \rightarrow \overline{WAIT} \uparrow$ delay time	t_{DSTWTE}	$2(1+X)t_{CYX}-55$	MAX.	273 (Note)	ns
$\overline{RD} \downarrow \rightarrow \overline{WAIT} \downarrow$ input time	t_{DRWTL}	$t_{CYX}-60$	MAX.	22	ns
$\overline{RD} \downarrow \rightarrow \overline{WAIT}$ retention time	t_{HRWT}	$(2X-1)t_{CYX}+5$	MIN.	87 (Note)	ns
$\overline{RD} \downarrow \rightarrow \overline{WAIT} \uparrow$ delay time	t_{DRWTE}	$(2X+1)t_{CYX}-60$	MAX.	186 (Note)	ns
$\overline{WAIT} \uparrow \rightarrow$ data input time	t_{DWTID}	$t_{CYX}-20$	MAX.	62	ns
$\overline{WAIT} \uparrow \rightarrow \overline{WR} \uparrow$ delay time	t_{DWTW}	$2t_{CYX}-10$	MIN.	154	ns
$\overline{WAIT} \uparrow \rightarrow \overline{RD} \uparrow$ delay time	t_{DWTR}	$t_{CYX}-10$	MIN.	72	ns
$\overline{WR} \downarrow \rightarrow \overline{WAIT} \downarrow$ input time (when refresh is disabled)	t_{DWWTL}	$t_{CYX}-60$	MAX.	22	ns
$\overline{WR} \downarrow \rightarrow$ \overline{WAIT} retention time	When refresh is disabled	t_{HWT1}	MIN.	87 (Note)	ns
	When refresh is enabled	t_{HWT2}	MIN.	5 (Note)	ns
$\overline{WR} \downarrow \rightarrow$ $\overline{WAIT} \uparrow$ delay time	When refresh is disabled	t_{DWWTH1}	MAX.	186 (Note)	ns
	When refresh is enabled	t_{DWWTH2}	MAX.	104 (Note)	ns
$\overline{RD} \downarrow \rightarrow \overline{REFRQ} \downarrow$ delay time	t_{DRRFQ}	$2t_{CYX}-10$	MIN.	154	ns
$\overline{WR} \downarrow \rightarrow \overline{REFRQ} \downarrow$ delay time	t_{DWRFQ}	$t_{CYX}-10$	MIN.	72	ns
\overline{REFRQ} low level width	t_{WRFQL}	$2t_{CYX}-44$	MIN.	120	ns
$\overline{REFRQ} \downarrow \rightarrow \overline{ASTB} \downarrow$ delay time	t_{DRFQST}	$4t_{CYX}-48$	MIN.	280	ns

Remarks 1: X: Number of external wait cycles (1, 2, ...)

2: $t_{CYX} \cong 82\text{ns}$ ($f_{XX}=12\text{MHz}$)

3: n denotes the number of wait cycles.

Note: When X=1.

Data retention characteristics (Ta = -10°C to 70°C)

Parameter	Symbol	Test condition	MIN.	TYP.	MAX.	Units
Data retention voltage	V _{DDDR}	STOP mode	2.5		5.5	V
Data retention current	I _{DDDR}	V _{DDDR} =2.5V		2	20	uA
		V _{DDDR} =5V±10%		5	50	uA
V _{DD} rise time	t _{RVD}		200			us
V _{DD} fall time	t _{FVD}		200			us
V _{DD} retention time from STOP mode setting	t _{HVD}		0			ms
STOP release signal input time	t _{DREL}		0			ms
Oscillation stable wait time	t _{WAIT}	Crystal resonator	30			ms
		Ceramic oscillator	5			ms
Input low voltage	V _{IL}	Specific pins (Note)	0		0.1 V _{DDDR}	V
Input high voltage	V _{IH}		0.9 V _{DDDR}		V _{DDDR}	V

Note: $\overline{\text{RESET}}$, P20/NMI, P21/INTP0, P22/INTP1, P23/INTP2/CI, P24/INTP3, P25/INTP4/ASCK, P26/INTP5, P27/SI, P32/ $\overline{\text{SCK}}$, P33/SO/SB0, and $\overline{\text{EA}}$ pins

AC Timing Test Points

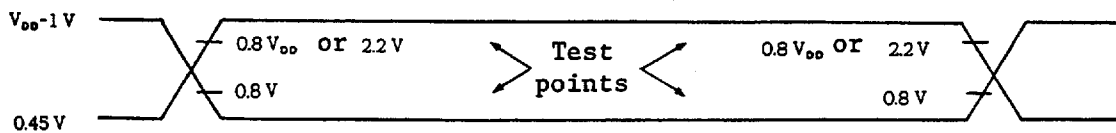

Timing Waveforms

Read operation

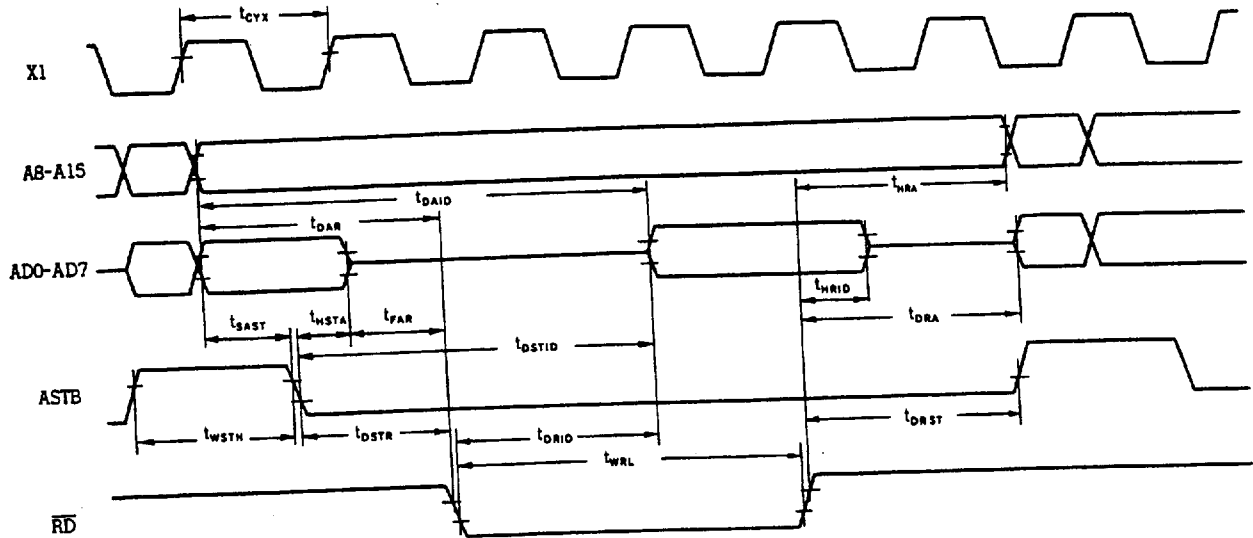

Write operation

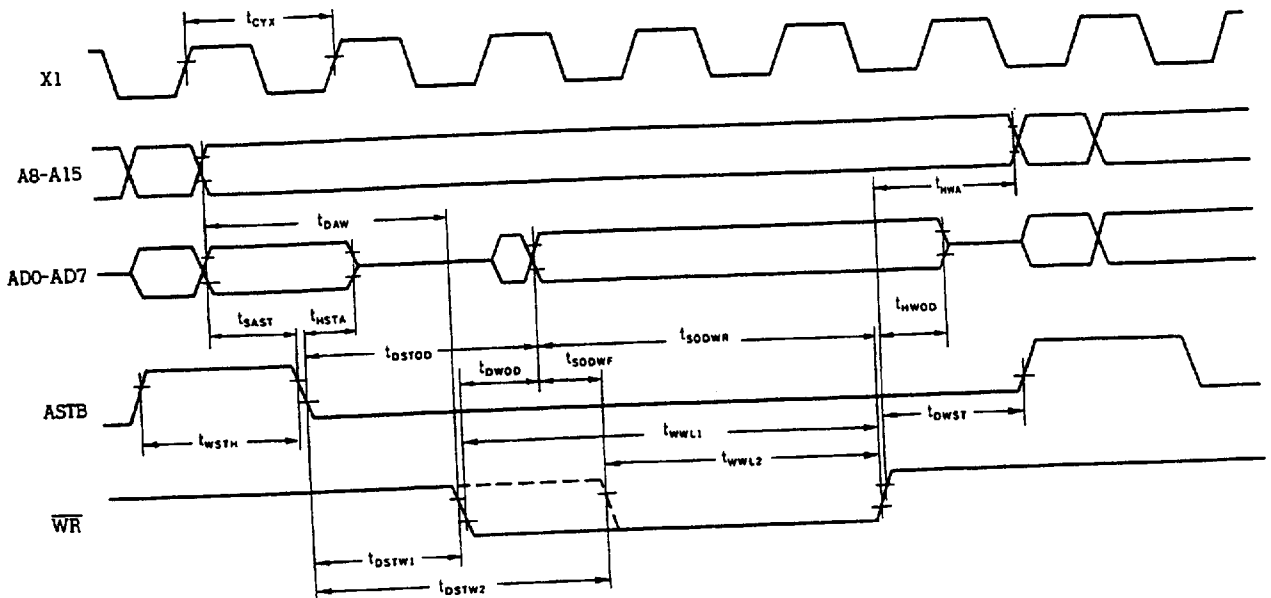

External WAIT Signal Input Timing

Read operation

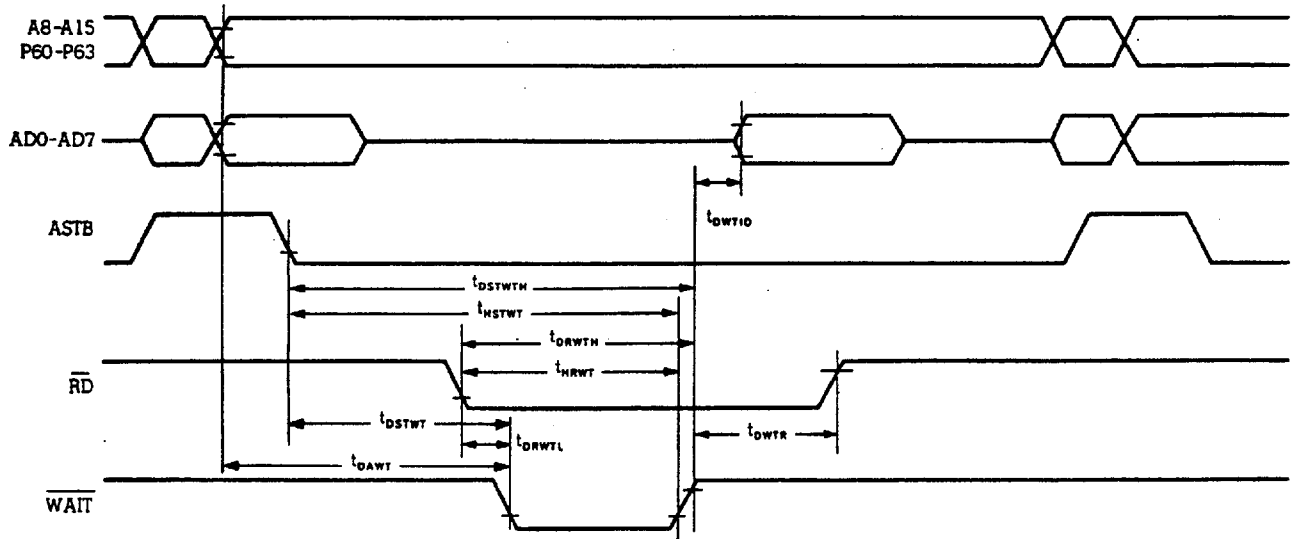

Write operation

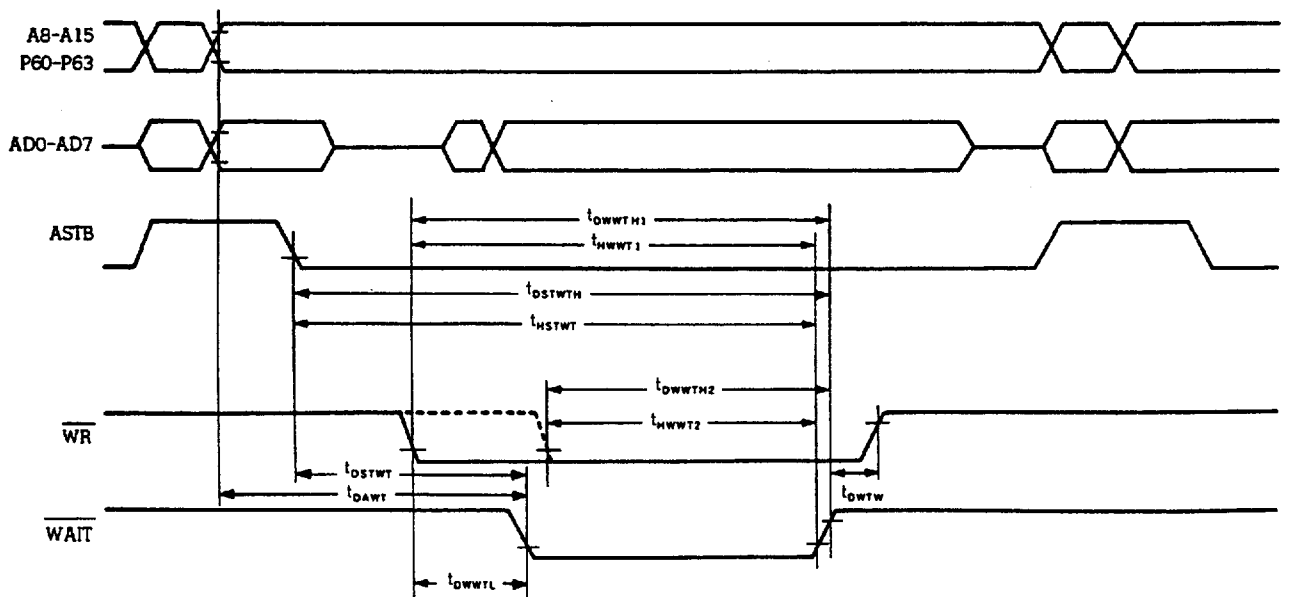

Refresh Timing Waveforms

Refresh after read

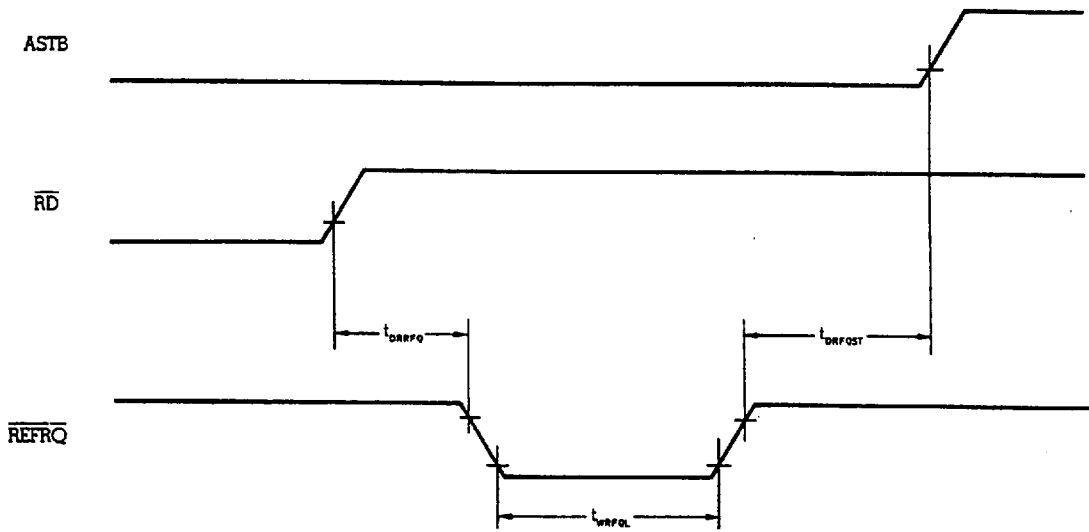

Refresh after write

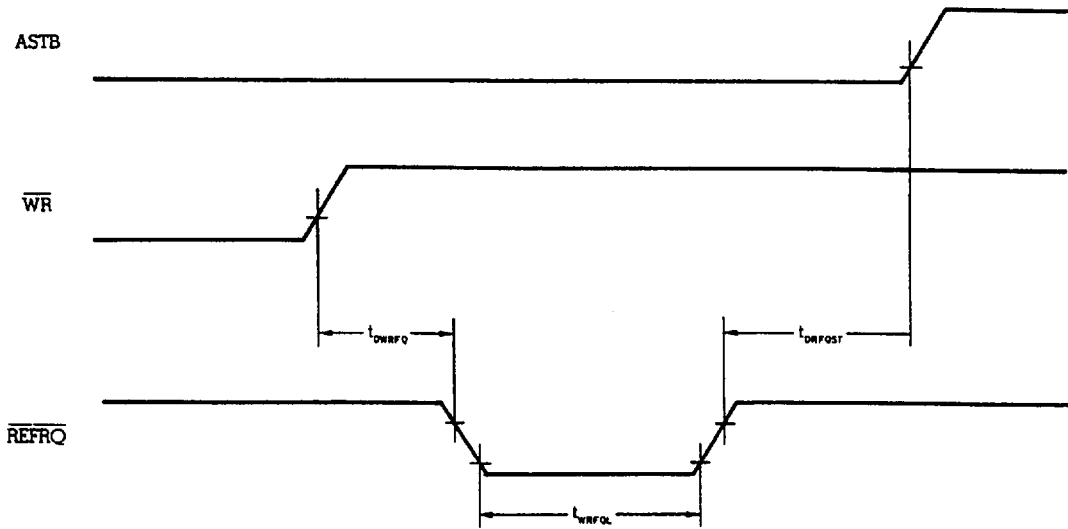

Serial Operation
3-line serial I/O mode

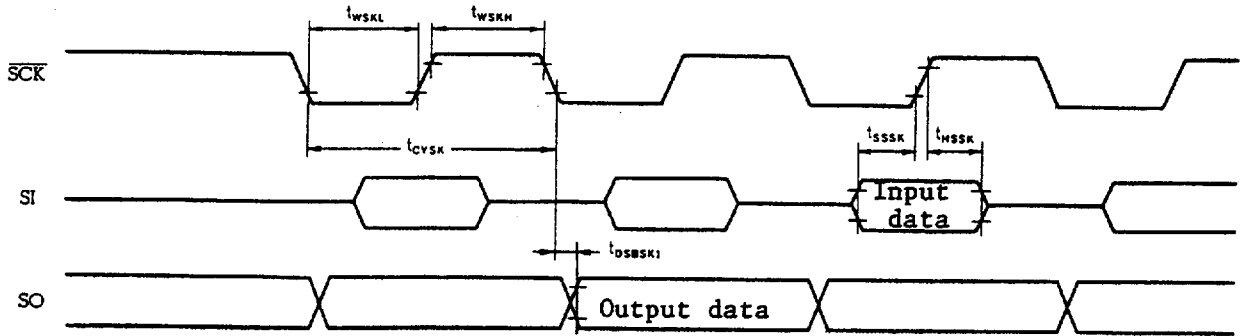

SBI Mode
Bus release signal transfer

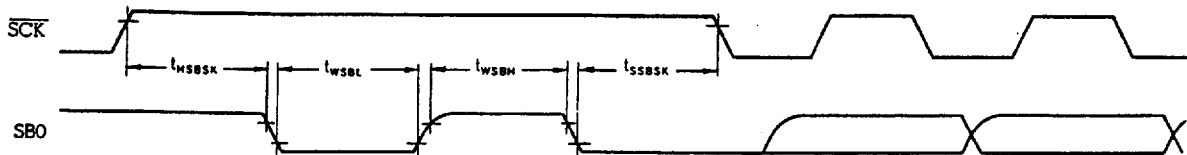

Command signal transfer

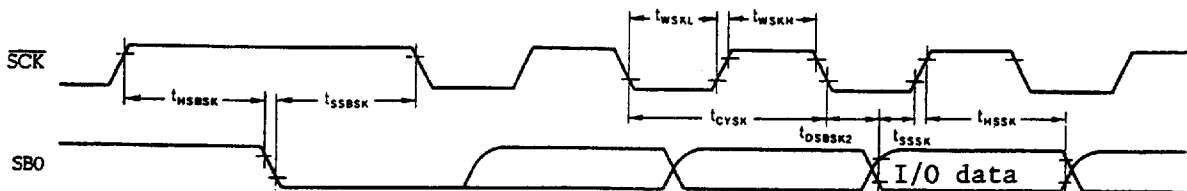

Interrupt Input Timing

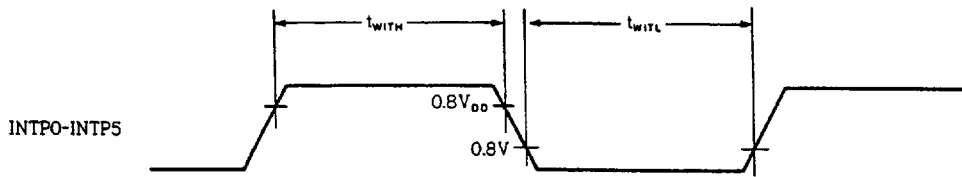
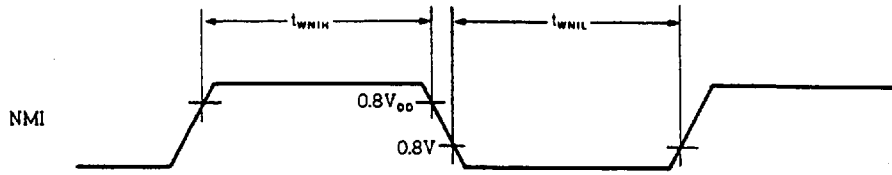

Reset Input Timing

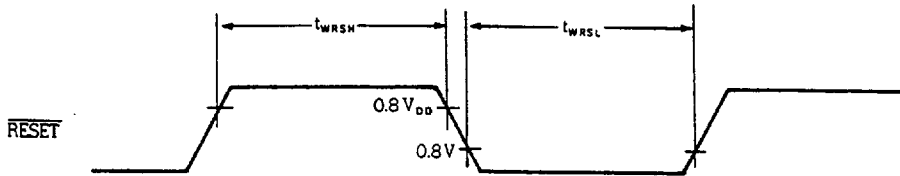

External Clock Timing

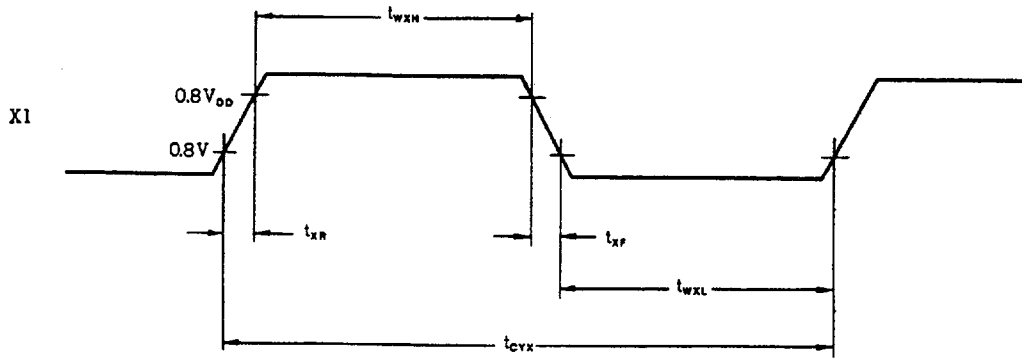

Data Retention Characteristics

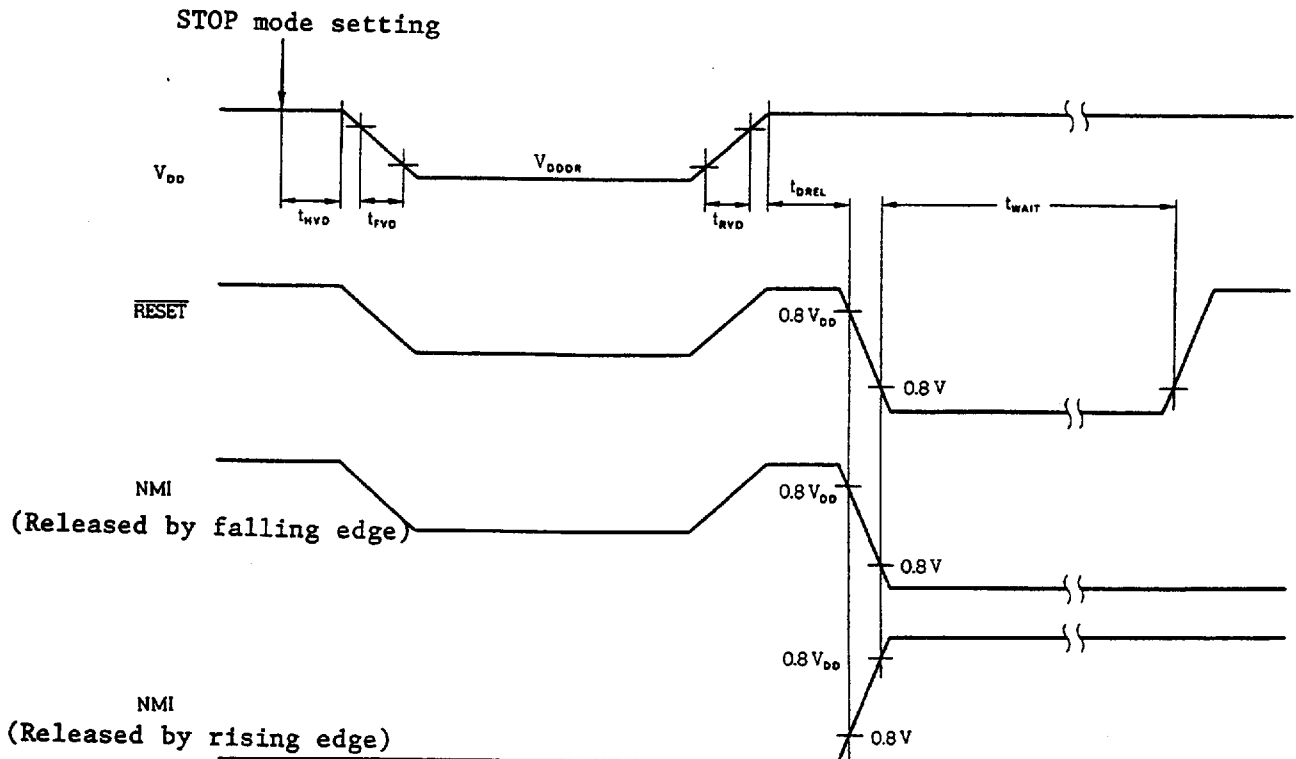

6. PACKAGE INFORMATION

64PIN PLASTIC SHRINK DIP (750 mil)

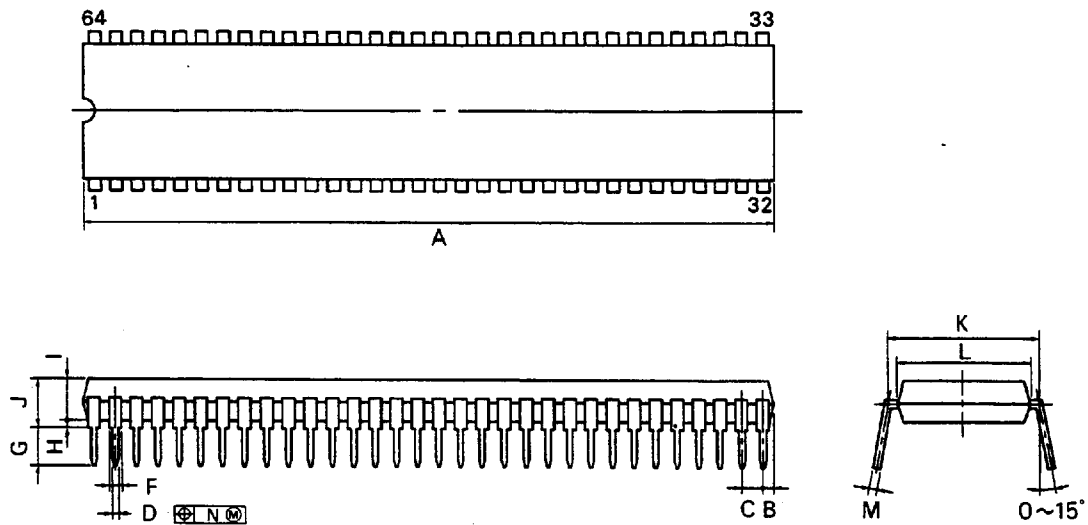

P64C-70-750A.C

NOTES

- 1) Each lead centerline is located within 0.17 mm (0.007 inch) of its true position (T.P.) at maximum material condition.
- 2) Item "K" to center of leads when formed parallel.

ITEM	MILLIMETERS	INCHES
A	58.68 MAX.	2.311 MAX.
B	1.78 MAX.	0.070 MAX.
C	1.778 (T.P.)	0.070 (T.P.)
D	0.50 ± 0.10	0.020 ± 0.004
F	0.9 MIN.	0.035 MIN.
G	3.2 ± 0.3	0.126 ± 0.012
H	0.51 MIN.	0.020 MIN.
I	4.31 MAX.	0.170 MAX.
J	5.08 MAX.	0.200 MAX.
K	19.05 (T.P.)	0.750 (T.P.)
L	17.0	0.669
M	0.25 ± 0.10	0.010 ± 0.003
N	0.17	0.007

64 PIN PLASTIC QFP (□14)

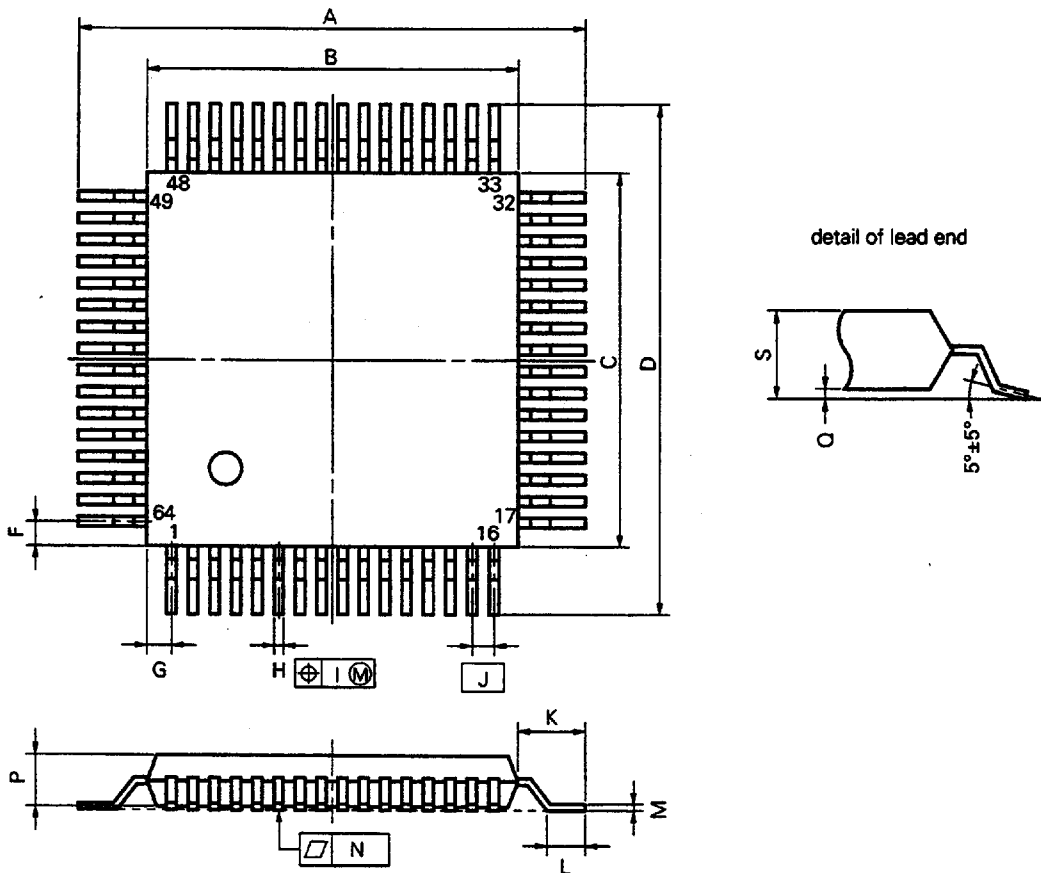

NOTE

Each lead centerline is located within 0.15 mm (0.006 inch) of its true position (T.P.) at maximum material condition.

P64GC-80-AB8-3

ITEM	MILLIMETERS	INCHES
A	17.6±0.4	0.693±0.016
B	14.0±0.2	0.551 ^{+0.009} _{-0.008}
C	14.0±0.2	0.551 ^{+0.009} _{-0.008}
D	17.6±0.4	0.693±0.016
F	1.0	0.039
G	1.0	0.039
H	0.35±0.10	0.014 ^{+0.004} _{-0.005}
I	0.15	0.006
J	0.8 (T.P.)	0.031 (T.P.)
K	1.8±0.2	0.071±0.008
L	0.8±0.2	0.031 ^{+0.009} _{-0.008}
M	0.15 ^{+0.10} _{-0.05}	0.006 ^{+0.004} _{-0.003}
N	0.10	0.004
P	2.55	0.100
Q	0.1±0.1	0.004±0.004
S	2.85 MAX.	0.112 MAX.