

NEC**MOS INTEGRATED CIRCUIT**
 μ PD78F0034**8-BIT SINGLE-CHIP MICROCONTROLLER****DESCRIPTION**

The μ PD78F0034 is a product of the μ PD780034 Subseries in the 78K/0 Series and equivalent to the μ PD780034 with a flash memory in place of internal ROM.

Because this device can be programmed without being removed from the substrate, it is suited for applications involving the evaluation of systems in development stages, small-scale production of many different products, and rapid development and time-to-market of a new product.

Functions are described in detail in the following user's manuals, which should be read when carrying out design work.

μ PD780024, 780024Y, 780034, 780034Y Subseries User's Manual: to be published soon
78K/0 Series User's Manual Instruction: IEU-1372

FEATURES

- Pin-compatible with mask ROM versions (except V_{PP} pin)
- Flash memory : 32 Kbytes
- Internal high-speed RAM : 1024 bytes^{Note}
- Operable with the same power supply voltage as that of mask ROM version ($V_{DD} = 1.8$ to 5.5 V)

Note The flash memory and internal high-speed RAM capacities can be changed with the memory size switching register (IMS).

Remark For the differences between the flash memory versions and the mask ROM versions, refer to 1. **DIFFERENCES BETWEEN μ PD78F0034 AND MASK ROM VERSIONS.**

ORDERING INFORMATION

Part Number	Package	Internal ROM
μ PD78F0034CW	64-pin plastic shrink DIP (750 mil)	Flash memory
μ PD78F0034GC-AB8	64-pin plastic QFP (14 × 14 mm)	Flash memory
μ PD78F0034GK-8A8 ^{Note}	64-pin plastic LQFP (12 × 12 mm)	Flash memory

Note Under planning

The information contained in this document is being issued in advance of the production cycle for the device. The parameters for the device may change before final production or NEC Corporation, at its own discretion, may withdraw the device prior to its production.

78K/0 SERIES DEVELOPMENT

The products in the 78K/0 series are listed below. The names enclosed in boxes are subseries names.

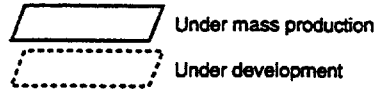

Y subseries supports I²C bus.

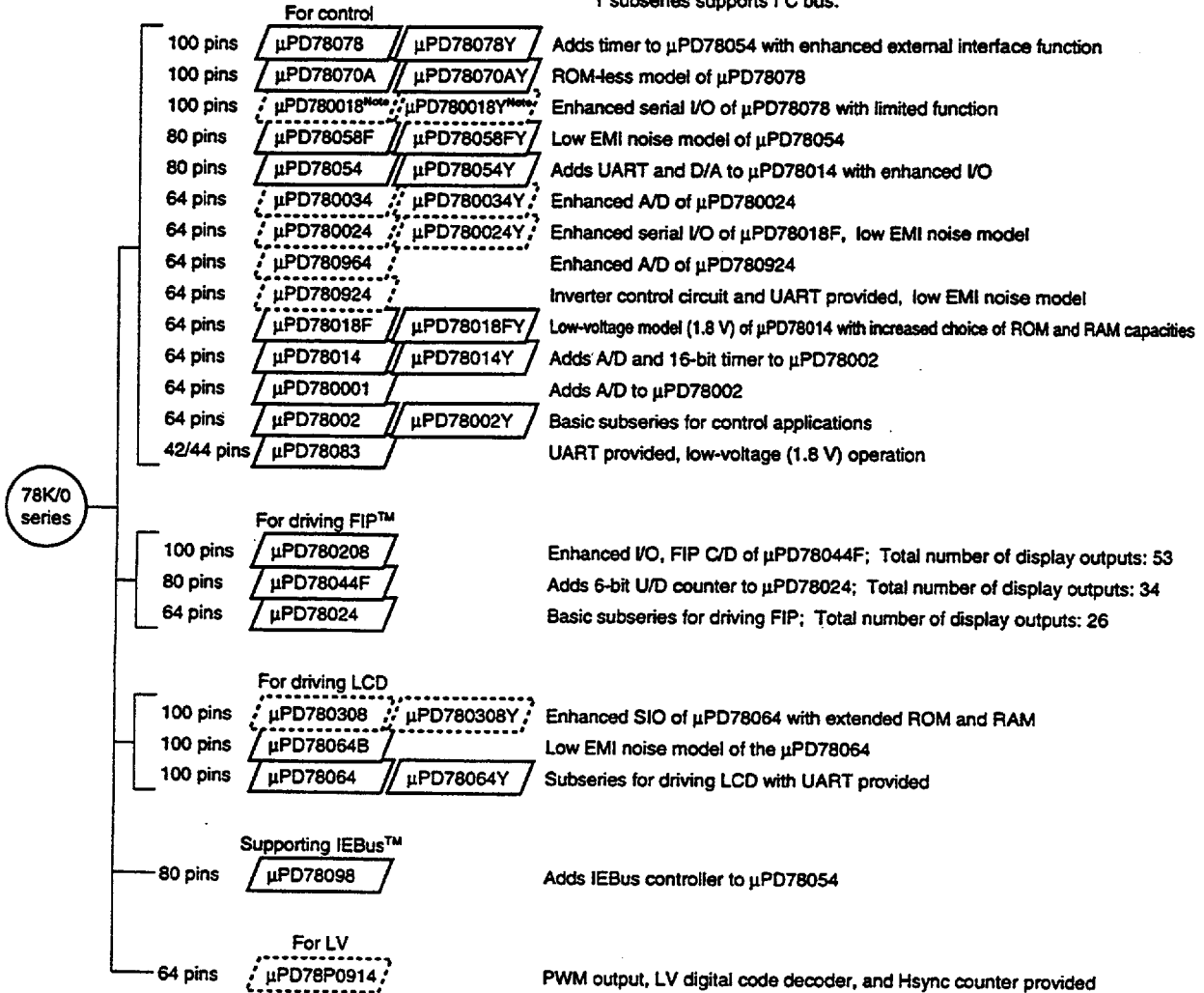

Note Under planning

The following lists the main functional differences.

Subseries	Function	ROM Capacity	Timer				8-bit	10-bit	8-bit	Serial Interface	I/O	V _{DD} MIN. Value	External Expansion						
			8-bit	16-bit	Watch	WDT	A/D	A/D	D/A										
For control	μPD78078	32 K to 60 K	4 ch	1 ch	1 ch	1 ch	8 ch	—	2 ch	3 ch (UART: 1 ch)	88	1.8 V	√						
	μPD78070A	—									61			2.7 V					
	μPD780018	48 K to 60 K	2 ch	—	—	—	—	8 ch	—	2 ch (Time division 3-wire: 1 ch)	88	1.8 V	—						
	μPD780034	8 K to 32 K								3 ch	Note			—	—	8 ch	3 ch (UART: 1 ch, Time division 3-wire: 1 ch)	51	
	μPD780024														8 ch	—	2 ch (UART: 2 ch)	47	2.7 V
	μPD780964														—	8 ch			
	μPD780924	8 ch								—									
	μPD78058F	48 K to 60 K								2 ch	—			—	—	—	—	2 ch	3 ch (UART: 1 ch)
	μPD78054	16 K to 60 K	—	2 ch	53	1.8 V	2.7 V												
	μPD78018F	8 K to 60 K																	
	μPD78014	8 K to 32 K																	
	μPD780001	8 K	—	—	—	—	—	1 ch	39	—	—								
	μPD78002	8 K to 16 K	—	1 ch	—	—	—	—	53	√	—								
μPD78083	8 K	—	—	—	—	8 ch	—	—	1 ch (UART: 1 ch)	33	1.8 V	—							
For FIP driving	μPD780208	32 K to 60 K	2 ch	1 ch	1 ch	1 ch	8 ch	—	—	2 ch	74	2.7 V	—						
	μPD78044F	16 K to 40 K									68								
	μPD78024	24 K to 32 K									54								
For LCD driving	μPD780308	48 K to 60 K	2 ch	1 ch	1 ch	1 ch	8 ch	—	—	3 ch (Time division UART: 1 ch)	57	1.8 V	—						
	μPD78064B	32 K									2 ch (UART: 1 ch)			2.0 V					
	μPD78064	16 K to 32 K																	
For IEBus	μPD78098	32 K to 60 K	2 ch	1 ch	1 ch	1 ch	8 ch	—	2 ch	3 ch (UART: 1 ch)	69	2.7 V	√						
For LV	μPD78P0914	32 K	6 ch	—	—	1 ch	8 ch	—	—	2 ch	54	4.5 V	√						

Note 10-bit timer: 1 channel

OVERVIEW OF FUNCTION

Item		Function
Internal memory	Flash memory	32 Kbytes ^{Note}
	High-speed RAM	1024 bytes ^{Note}
Memory space		64 Kbytes
General-purpose registers		8 bits x 32 registers (8 bits x 8 registers x 4 banks)
Instruction cycle		On-chip instruction execution time cycle modification function
	When main system clock selected	0.24 μs/0.48 μs/0.95 μs/1.91 μs/3.81 μs (at 8.38-MHz operation)
	When subsystem clock selected	122 μs (at 32.768-kHz operation)
Instruction set		<ul style="list-style-type: none"> • 16-bit operation • Multiplication/division (8 bits x 8 bits, 16 bits + 8 bits) • Bit manipulation (set, reset, test, boolean operation) • BCD correction, etc.
I/O ports		Total : 51 <ul style="list-style-type: none"> • CMOS input : 8 • CMOS I/O : 39 • N-ch open drain I/O (5-V resistance) : 4
A/D converter		<ul style="list-style-type: none"> • 10-bit resolution x 8 channels • Operable over a wide power supply voltage range: AV_{DD} = 1.8 to 5.5 V
Serial interface		<ul style="list-style-type: none"> • UART mode : 1 channel • 3-wire serial I/O mode : 2 channels
Timer		<ul style="list-style-type: none"> • 16-bit timer/event counter : 1 channel • 8-bit timer/event counter : 2 channels • Watch timer : 1 channel • Watchdog timer : 1 channel
Timer output		3 (8-bit PWM output capable: 2)
Clock output		131 kHz, 262 kHz, 524 kHz, 1.05 MHz, 2.10 MHz, 4.19 MHz, 8.38 MHz (main system clock: at 8.38-MHz operation) 32.768 kHz (subsystem clock: at 32.768-kHz operation)
Buzzer output		1.02 kHz, 2.05 kHz, 4.10 kHz, 8.19 kHz (main system clock: at 8.38-MHz operation)
Vectored-interrupt source	Maskable	Internal : 14 External : 4
	Non-maskable	Internal : 1
	Software	1
Test input		Internal : 1 External : 1
Power supply voltage		V _{DD} = 1.8 to 5.5 V
Operating ambient temperature		T _A = -40 to +85°C
Package		<ul style="list-style-type: none"> • 64-pin plastic shrink DIP (750 mil) • 64-pin plastic QFP (14 x 14 mm) • 64-pin plastic LQFP (12 x 12 mm, Under planning)

Note The capacities of the flash memory and the internal high-speed RAM can be changed with the memory size switching register (IMS).

PIN CONFIGURATION (TOP VIEW)

- 64-Pin Plastic Shrink DIP (750 mil)
μPD78F0034CW

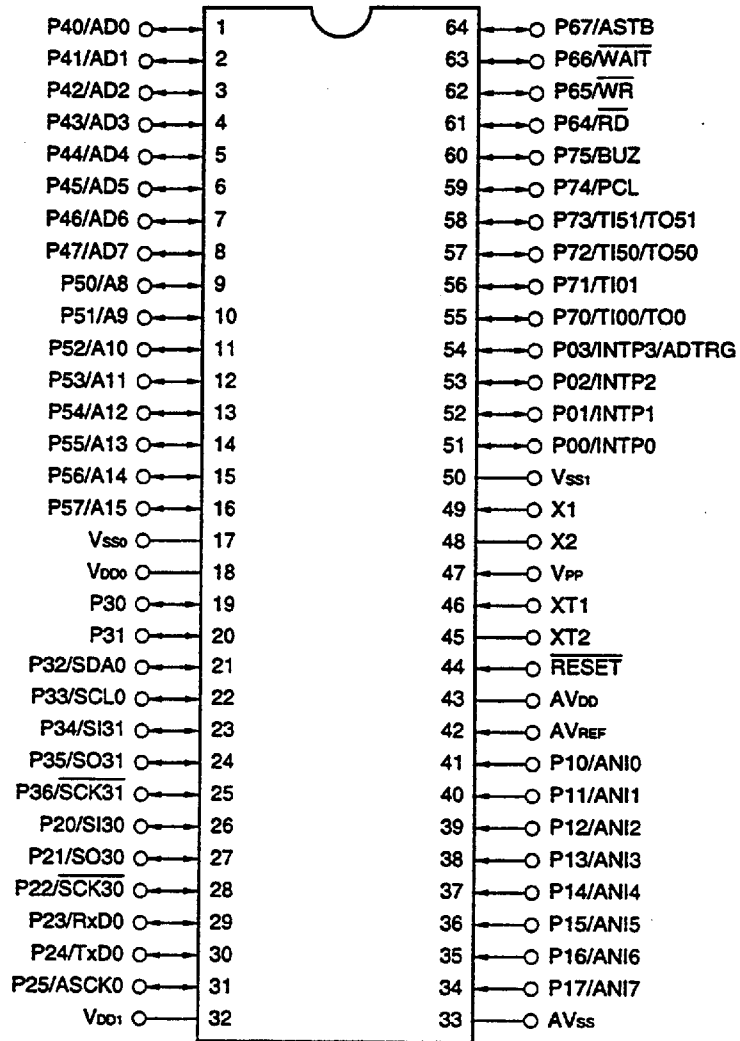

- Cautions**
1. Connect the Vpp pin directly to Vss0 in normal operation mode.
 2. Connect the AVss pin to Vss0.

Remark When the μPD78F0034 is used in application fields that require reduction of the noise generated from inside the microcontroller, the implementation of noise reduction measures, such as supplying voltage to Vdd0 and Vdd1 individually and connecting Vss0 and Vss1 to different ground lines, is recommended.

- 64-Pin Plastic QFP (14 × 14 mm)
μPD78F0034GC-AB8
- 64-Pin Plastic LQFP (12 × 12 mm)
μPD78F0034GK-8A8^{Note}

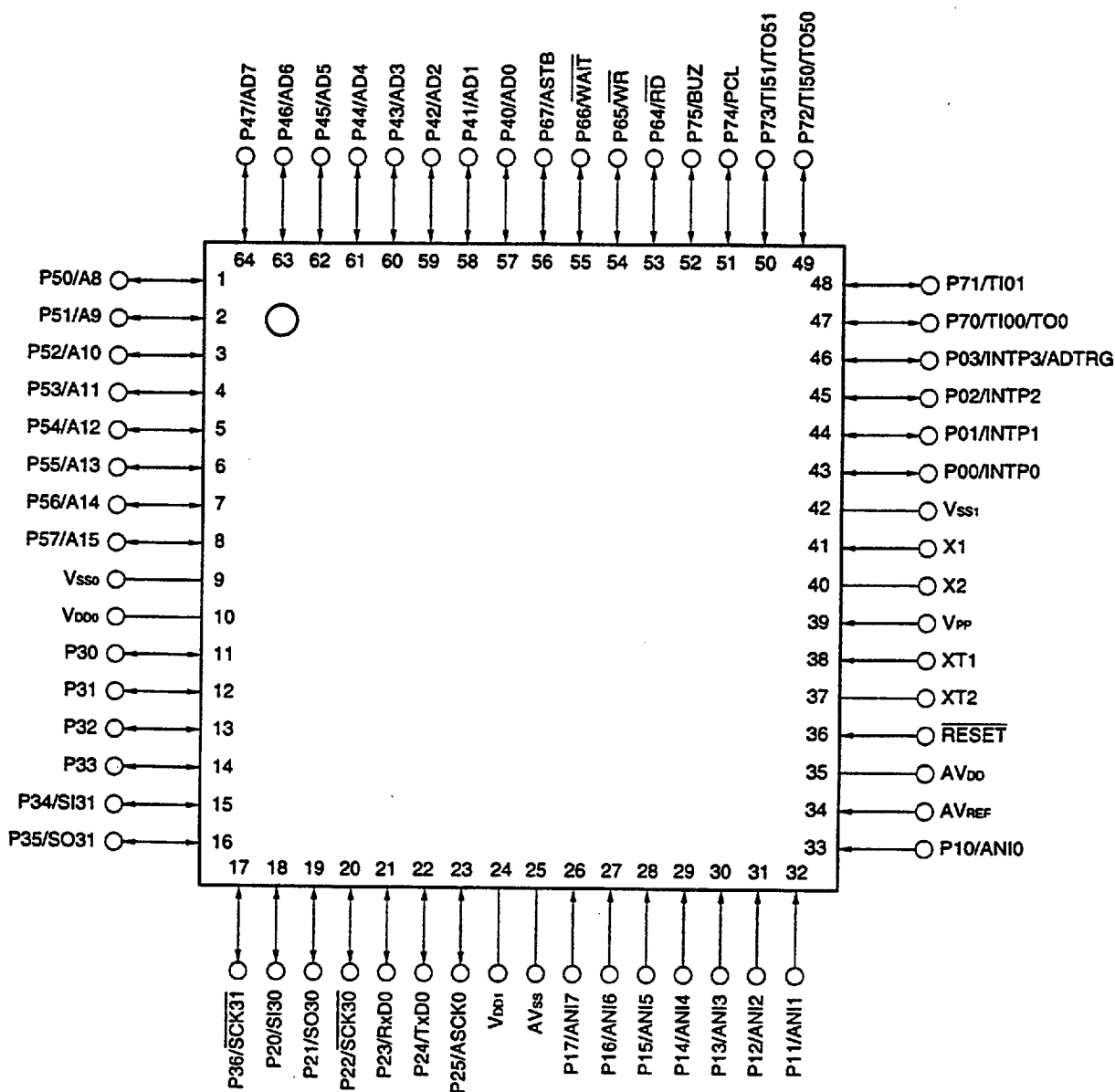

Note Under planning

- Cautions**
1. Connect the VPP pin directly to VSS0 in normal operation mode.
 2. Connect the AVSS pin to VSS0.

Remark When the μPD78F0034 is used in application fields that require reduction of the noise generated from inside the microcontroller, the implementation of noise reduction measures, such as supplying voltage to VDD0 and VDD1 individually and connecting VSS0 and VSS1 to different ground lines, is recommended.

A8 to A15	: Address Bus	P70 to P75	: Port 7
AD0 to AD7	: Address/Data Bus	PCL	: Programmable Clock
ADTRG	: AD Trigger Input	\overline{RD}	: Read Strobe
ANI0 to ANI7	: Analog Input	\overline{RESET}	: Reset
ASCK0	: Asynchronous Serial Clock	RxD0	: Receive Data
ASTB	: Address Strobe	$\overline{SCK30}, \overline{SCK31}$: Serial Clock
AV _{DD}	: Analog Power Supply	SI30, SI31	: Serial Input
AV _{REF}	: Analog Reference Voltage	SO30, SO31	: Serial Output
AV _{SS}	: Analog Ground	TI00, TI01, TI50, TI51	: Timer Input
BUZ	: Buzzer Clock	TO0, TO50, TO51	: Timer Output
INTP1 to INTP3	: Interrupt from Peripherals	TxD0	: Transmit Data
P00 to P03	: Port 0	V _{DD0} , V _{DD1}	: Power Supply
P10 to P17	: Port 1	V _{PP}	: Programming Power Supply
P20 to P25	: Port 2	V _{SS0} , V _{SS1}	: Ground
P30 to P36	: Port 3	\overline{WAIT}	: Wait
P40 to P47	: Port 4	\overline{WR}	: Write Strobe
P50 to P57	: Port 5	X1, X2	: Crystal (Main System Clock)
P64 to P67	: Port 6	XT1, XT2	: Crystal (Subsystem Clock)

BLOCK DIAGRAM

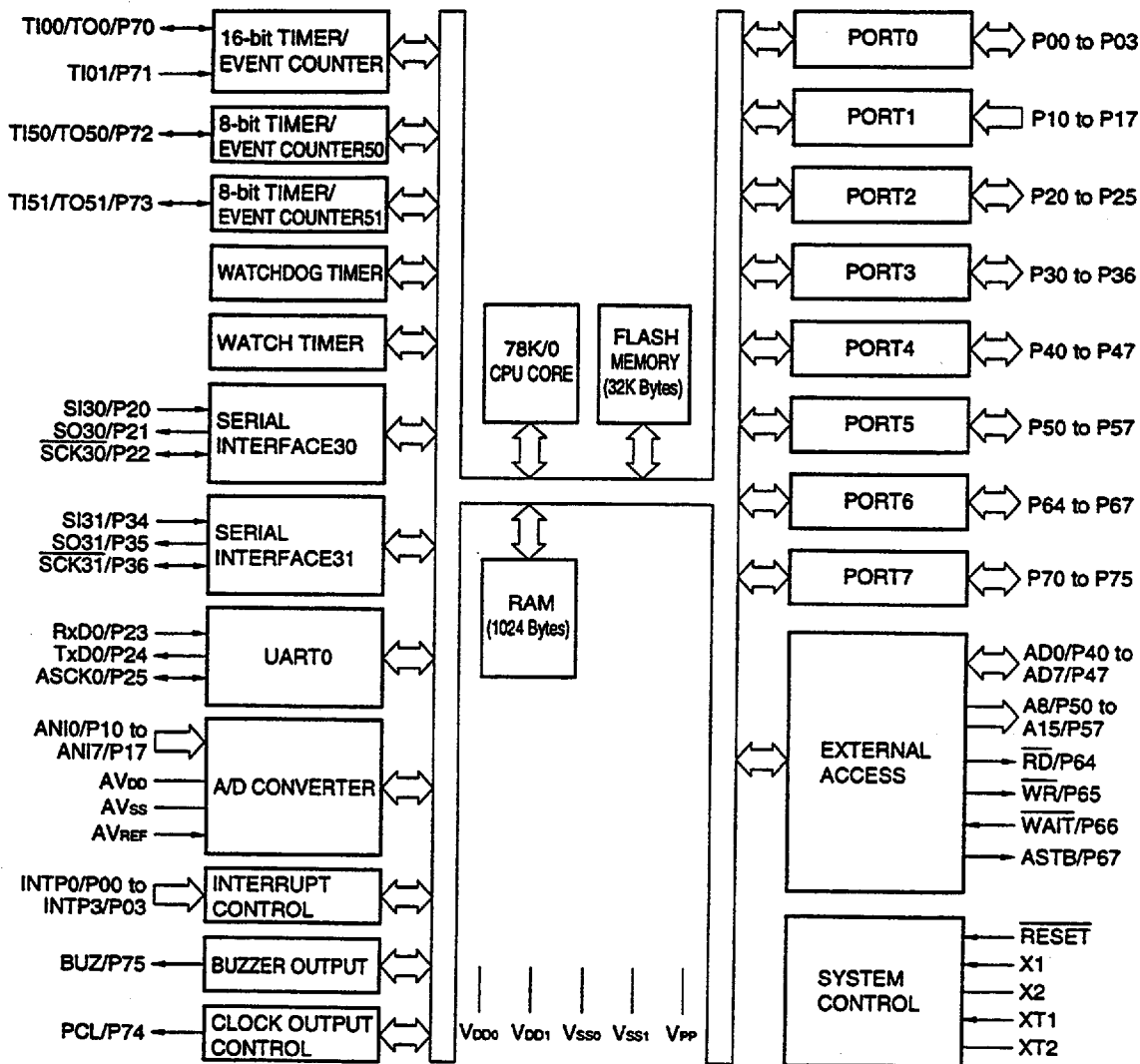

CONTENTS

1. DIFFERENCES BETWEEN μPD78F0034 AND MASK ROM VERSIONS 10

2. PIN FUNCTIONS..... 11

2.1 Port Pins..... 11

2.2 Non-Port Pins 12

2.3 Recommended Connection of Unused Pins..... 14

3. MEMORY SIZE SWITCHING REGISTER (IMS)..... 15

4. FLASH MEMORY PROGRAMMING 16

4.1 Selection of Transmission Method 16

4.2 Function of Flash Memory Programming 17

4.3 Connection of Flashpro 17

5. PACKAGE DRAWINGS..... 19

APPENDIX A. DEVELOPMENT TOOLS 22

APPENDIX B. RELATED DOCUMENTS 24

1. DIFFERENCES BETWEEN μPD78F0034 AND MASK ROM VERSIONS

The μPD78F0034 is a product provided with a flash memory which enables on-board reading, erasing, and rewriting of programs with device mounted on target system.

The functions of the μPD78F0034 (except the functions specified for flash memory) can be made the same as those of the mask ROM versions by setting the memory size switching register (IMS).

Table 1-1 shows the differences between the flash memory version (μPD78F0034) and the mask ROM versions (μPD780031, 780032, 780033, and 780034).

Table 1-1. Differences between μPD78F0034 and Mask ROM Versions

Item	μPD78F0034	Mask ROM Versions
Internal ROM structure	Flash memory	Mask ROM
Internal ROM capacity	32 Kbytes	μPD780031 : 8 Kbytes μPD780032 : 16 Kbytes μPD780033 : 24 Kbytes μPD780034 : 32 Kbytes
Internal high-speed RAM capacity	1024 bytes	μPD780031 : 512 bytes μPD780032 : 512 bytes μPD780033 : 1024 bytes μPD780034 : 1024 bytes
Internal ROM and internal high-speed RAM capacity changeable/not changeable with memory size switching register	Changeable ^{Note}	Not changeable
IC pin	Not provided	Provided
V _{PP} pin	Provided	Not provided
Electrical specifications	Refer to the data sheet of individual products.	

Note Flash memory is set to 32 Kbytes and internal high-speed RAM is set to 1024 bytes by $\overline{\text{RESET}}$ input.

2. PIN FUNCTIONS

2.1 Port Pins (1/2)

Pin Name	I/O	Function		After Reset	Alternate Function
P00	I/O	Port 0 4-bit input/output port. Input/output can be specified bit-wise. When used as an input port, an internal pull-up resistor can be connected by software.		Input	INTP0
P01					INTP1
P02					INTP2
P03					INTP3/ADTRG
P10 to P17	Input	Port 1 8-bit input only port.		Input	ANI0 to ANI7
P20	I/O	Port 2 6-bit input/output port. Input/output can be specified bit-wise. When used as an input port, an internal pull-up resistor can be connected by software.		Input	SI30
P21					SO30
P22					SCK30
P23					RxD0
P24					TxD0
P25					ASCK0
P30	I/O	Port 3 7-bit input/output port. Input/output can be specified bit-wise.	N-ch open drain input/output port. LED can be driven directly. When used as an input port, an internal pull-up resistor can be connected by software.	Input	—
P31					
P32					
P33					
P34					
P35					SI31
P36					SO31
P40 to P47	I/O	Port 4 8-bit input/output port. Input/output can be specified bit-wise. When used as an input port, an internal pull-up resistor can be connected by software. Test input flag (KRIF) is set to 1 by the falling edge detection.		Input	AD0 to AD7
P50 to P57	I/O	Port 5 8-bit input/output port. LED can be driven directly. Input/output can be specified bit-wise. When used as an input port, an internal pull-up resistor can be connected by software.		Input	A8 to A15
P64	I/O	Port 6 4-bit input/output port. Input/output can be specified bit-wise. When used as an input port, an internal pull-up resistor can be connected by software.		Input	\overline{RD}
P65					\overline{WR}
P66					\overline{WAIT}
P67					ASTB

2.1 Port Pins (2/2)

Pin Name	I/O	Function	After Reset	Alternate Function
P70	I/O	Port 7 6-bit input/output port. Input/output can be specified bit-wise. When used as an input port, an internal pull-up resistor can be connected by software.	Input	TI00/TO0
P71				TI01
P72				TI50/TO50
P73				TI51/TO51
P74				PCL
P75				BUZ

2.2 Non-Port Pins (1/2)

Pin Name	I/O	Function	After Reset	Alternate Function
INTP0	Input	External interrupt input by which the effective edge (rising edge, falling edge, or both rising edge and falling edge) can be specified.	Input	P00
INTP1				P01
INTP2				P02
INTP3				P03/ADTRG
SI30	Input	Serial interface serial data input.	Input	P20
SI31				P34
SO30	Output	Serial interface serial data output.	Input	P21
SO31				P35
SCK30	I/O	Serial interface serial clock input/output.	Input	P22
SCK31				P36
RxD0	Input	Serial data input for asynchronous serial interface.	Input	P23
TxD0	Output	Serial data output for asynchronous serial interface.	Input	P24
ASCK0	Input	Serial clock input for asynchronous serial interface.	Input	P25
TI00	Input	External count clock input to 16-bit timer (TM0).	Input	P70/TO0
TI01				P71
TI50		External count clock input to 8-bit timer (TM50).		P72/TO50
TI51				P73/TO51
TO0	Output	16-bit timer (TM0) output.	Input	P70/TO0
TO50		8-bit timer (TM50) output (shared with 8-bit PWM output).		P72/TO50
TO51		8-bit timer (TM51) output (shared with 8-bit PWM output).		P73/TO51
PCL	Output	Clock output (for trimming of main system clock and subsystem clock).	Input	P74
BUZ	Output	Buzzer output.	Input	P75
AD0 to AD7	I/O	Lower address/data bus for extending memory externally.	Input	P40 to P47
A8 to A15	Output	Higher address bus for extending memory externally.	Input	P50 to P57
RD	Output	Strobe signal output for read operation of external memory.	Input	P64
WR		Strobe signal output for write operation of external memory.		P65
WAIT	Input	Inserting wait for accessing external memory.	Input	P66
ASTB	Output	Strobe output which externally latches address information output to port 4 and port 5 to access external memory.	Input	P67

2.2 Non-Port Pins (2/2)

Pin Name	I/O	Function	After Reset	Alternate Function
ANI0 to ANI7	Input	A/D converter analog input.	Input	P10 to P17
ADTRG	Input	A/D converter trigger signal input.	Input	P03/INTP3
AVREF	Input	A/D converter reference voltage input.	—	—
AVDD	—	A/D converter analog power supply. Voltage equal to VDD0 or VDD1.	—	—
AVSS	—	A/D converter ground potential. Voltage equal to VSS0 or VSS1.	—	—
RESET	Input	System reset input.	—	—
X1	Input	Connecting crystal resonator for main system clock oscillation.	—	—
X2	—		—	—
XT1	Input	Connecting crystal resonator for subsystem clock oscillation.	—	—
XT2	—		—	—
VDD0	—	Positive power supply voltage for ports.	—	—
VSS0	—	Ground potential of ports.	—	—
VDD1	—	Positive power supply (except ports).	—	—
VSS1	—	Ground potential (except ports).	—	—
VPP	—	Applying high-voltage for program write/verify. Connected directly to VSS0 in normal operation mode.	—	—

2.3 Recommended Connection of Unused Pins

Table 2-1 shows the recommended connection of unused pins.

Table 2-1. Recommended Connection of Unused Pins

Pin Name	I/O	Recommended Connection when Not Used	
P00/INTP0	I/O	Independently connected to V _{SS0} through a resistor.	
P01/INTP1			
P02/INTP2			
P03/INTP3/ADTRG			
P10/ANI0 to P17/ANI7	Input	Independently connected to V _{DD0} or V _{SS0} through a resistor.	
P20/SI30	I/O		
P21/SO30			
P22/SCK30			
P23/RxD0			
P24/TxD0			
P25/ASCK0			
P30 to P33			
P34/SI31			
P35/SO31			
P36/SCK31			
P40/AD0 to P47/AD7			Independently connected to V _{DD0} through a resistor.
P50/A8 to P57/A15			Independently connected to V _{DD0} or V _{SS0} through a resistor.
P64/RD			
P65/WR			
P66/WAIT			
P67/ASTB			
P70/TI00/TO0			
P71/TI01			
P72/TI50/TO50			
P73/TI51/TO51			
P74/PCL			
P75/BUZ			
RESET	Input	—	
XT1	—	Connected to V _{DD0} .	
XT2		Left open.	
AV _{REF}		Connected to V _{SS0} .	
AV _{DD}		Connected to V _{DD0} .	
AV _{SS}		Connected to V _{SS0} .	
V _{PP}		Connected directly to V _{SS0} .	

3. MEMORY SIZE SWITCHING REGISTER (IMS)

This register sets a part of internal memory unused by software. The memory mapping can be made the same as that of mask ROM versions with different types of internal memory (ROM and RAM).

The IMS is set with an 8-bit memory manipulation instruction.

RESET input sets the IMS to C8H.

Figure 3-1. Format of Memory Size Switching Register

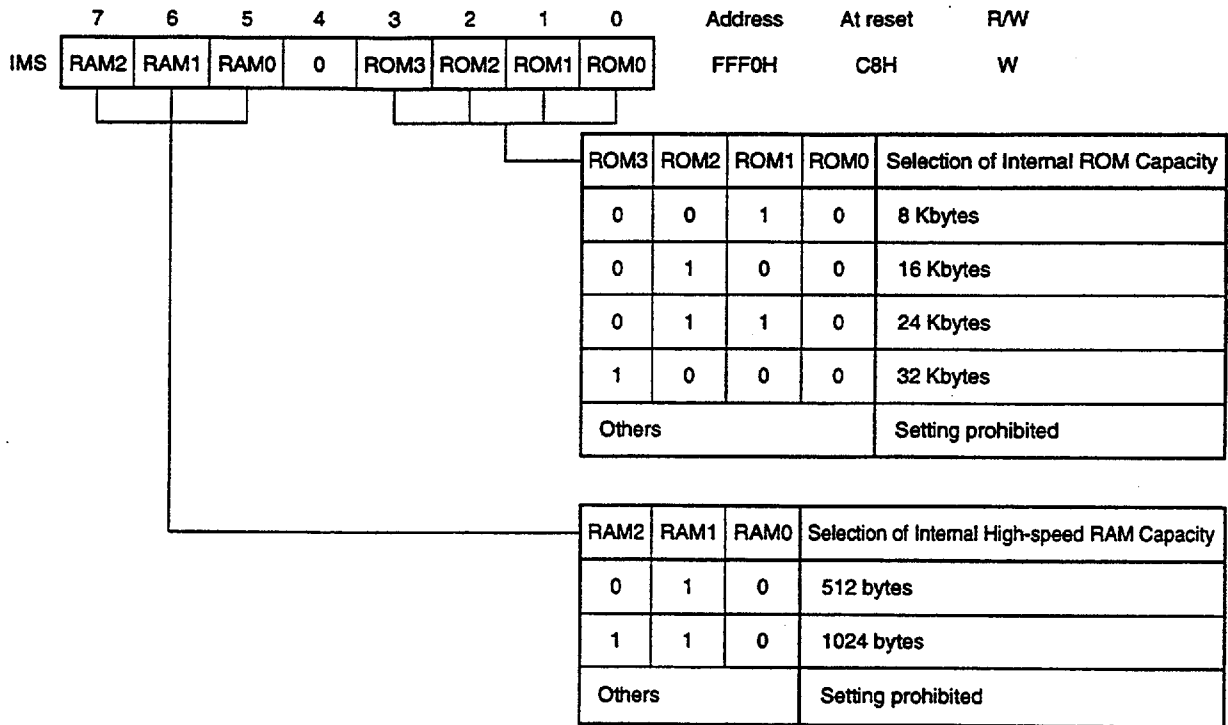

Table 3-1 shows the IMS set value to make the memory mapping the same as those of mask ROM versions.

Table 3-1. Set Value of Memory Size Switching Register

Target Mask ROM Versions	IMS Set Value
μPD780031	42H
μPD780032	44H
μPD780033	C6H
μPD780034	C8H

4. FLASH MEMORY PROGRAMMING

Writing to a flash memory can be performed without removing the memory from the target system. Writing is performed connecting the dedicated flash programmer (Flashpro) to the host machine and the target system.

Remark Flashpro is a product of Naitou Densai Machidaseisakusho Co., Ltd.

4.1 Selection of Transmission Method

Writing to a flash memory is performed using the Flashpro with a serial transmission mode. One of the transmission method is selected from those in Table 4-1. The selection of the transmission method is made by using the format shown in Figure 4-1. Each transmission method is selected by the number of V_{PP} pulses shown in Table 4-1.

Table 4-1. List of Transmission Method

Transmission Method	Channels	Pin	V _{PP} Pulses
3-wire serial I/O	2	SI30/P20 SO30/P21 SCK30/P22	0
		SI31/P34 SO31/P35 SCK31/P36	1
UART	1	RxD0/P23 TxD0/P24 ASCK0/P25	8
Pseudo 3-wire serial I/O	1	P72/TI50/TO50 (serial clock input) P71/TI01 (serial data output) P70/TI00/TO0 (serial data input)	12

Caution Select a communication system always using the number of V_{PP} pulses shown in Table 4-1.

Figure 4-1. Format of Transmission Method Selection

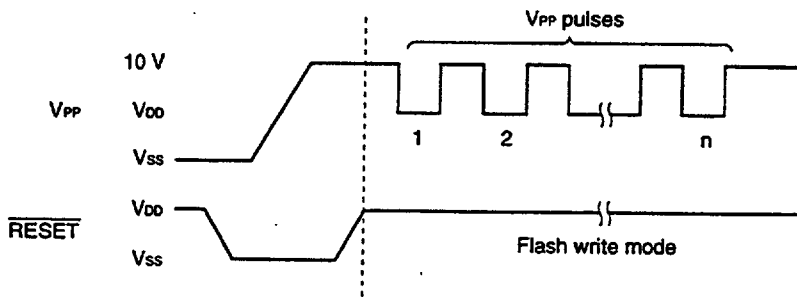

4.2 Function of Flash Memory Programming

Operations such as writing to a flash memory are performed by various command/data transmission and reception operations according to the selected transmission method. Table 4-2 shows major functions of flash memory programming.

Table 4-2. Major Functions of Flash Memory Programming

Functions	Descriptions
Reset	Used to stop write operation and detect transmission cycle.
Batch verify	Compares the entire memory contents with the input data.
Batch delete	Deletes the entire memory contents.
Batch blank check	Checks the deletion status of the entire memory.
High-speed write	Performs write to the flash memory based on the write start address and the number of data to be written (number of bytes).
Continuous write	Performs continuous write based on the information input with high-speed write operation.
Status	Used to confirm the current operating mode and operation end.
Oscillation frequency setting	Sets the frequency of the resonator.
Delete time setting	Sets the memory delete time.
Silicon signature read	Outputs the device name and memory capacity, and device block information.

4.3 Connection of Flashpro

The connection of the Flashpro and the μPD78F0034 differs according to the transmission method (3-wire serial I/O, UART pseudo 3-wire serial I/O). The connection for each transmission method is shown in Figures 4-2 and 4-3, respectively.

Figure 4-2. Connection of Flashpro for 3-wire Serial I/O System

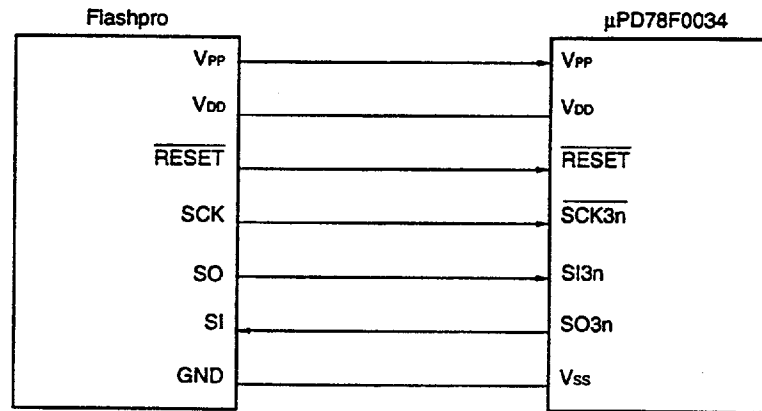

n = 0, 1

Figure 4-3. Connection of the Flashpro for UART System

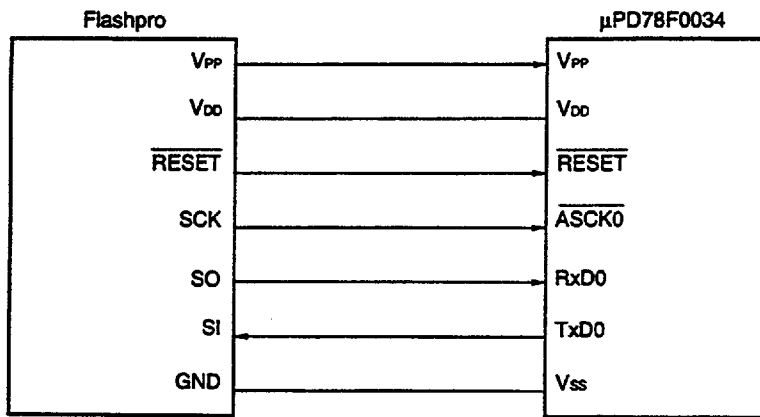
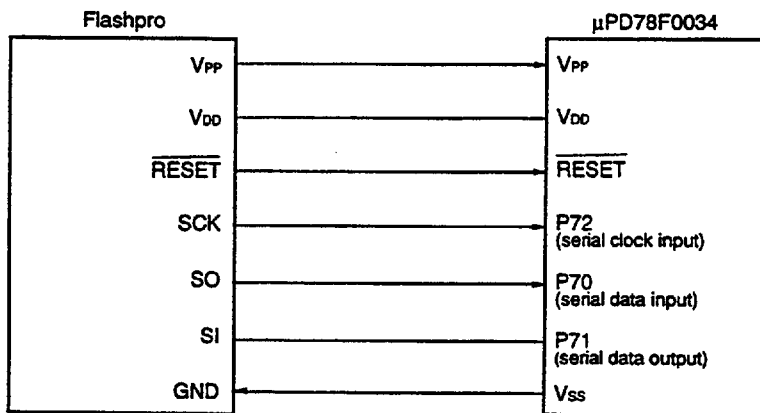
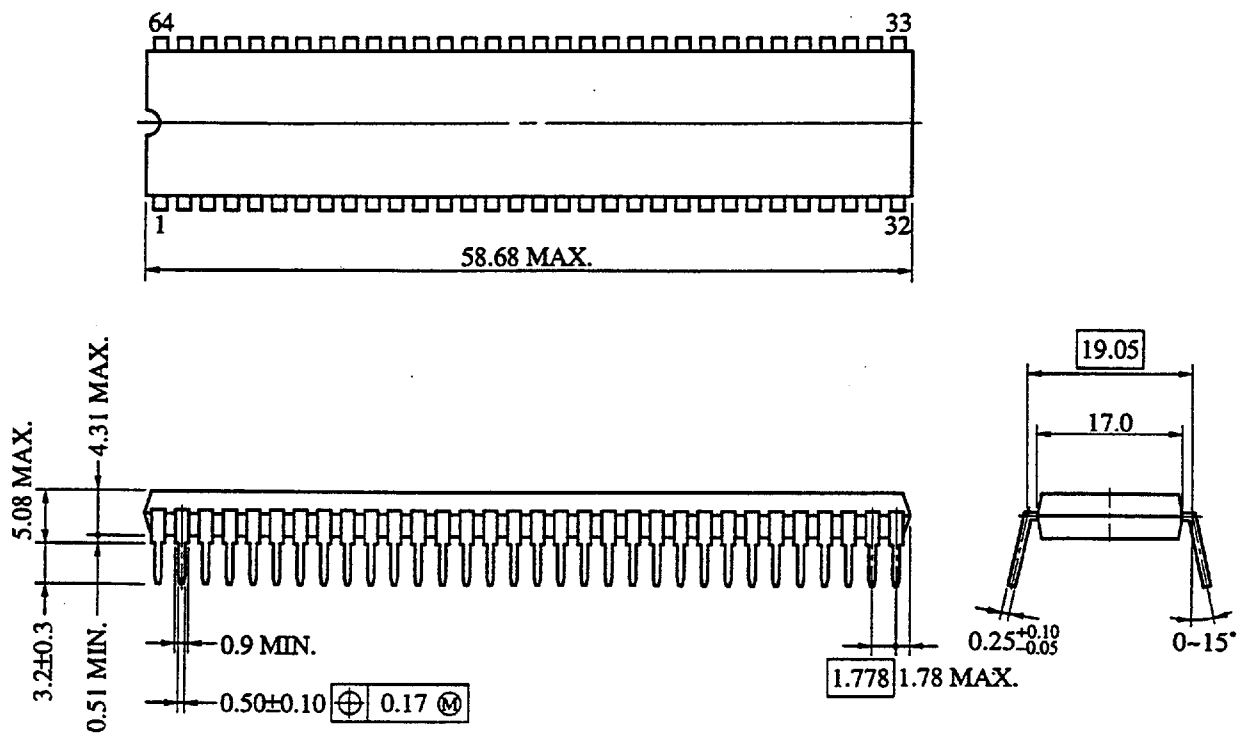

Figure 4-4. Connection of Flashpro Using Pseudo 3-Wire Serial I/O Method



5. PACKAGE DRAWINGS

64-PIN PLASTIC SHRINK DIP (750 mil) (Unit: mm)



P64C-70-750A,C-1

64-PIN PLASTIC QFP (14 x 14) (Unit: mm)

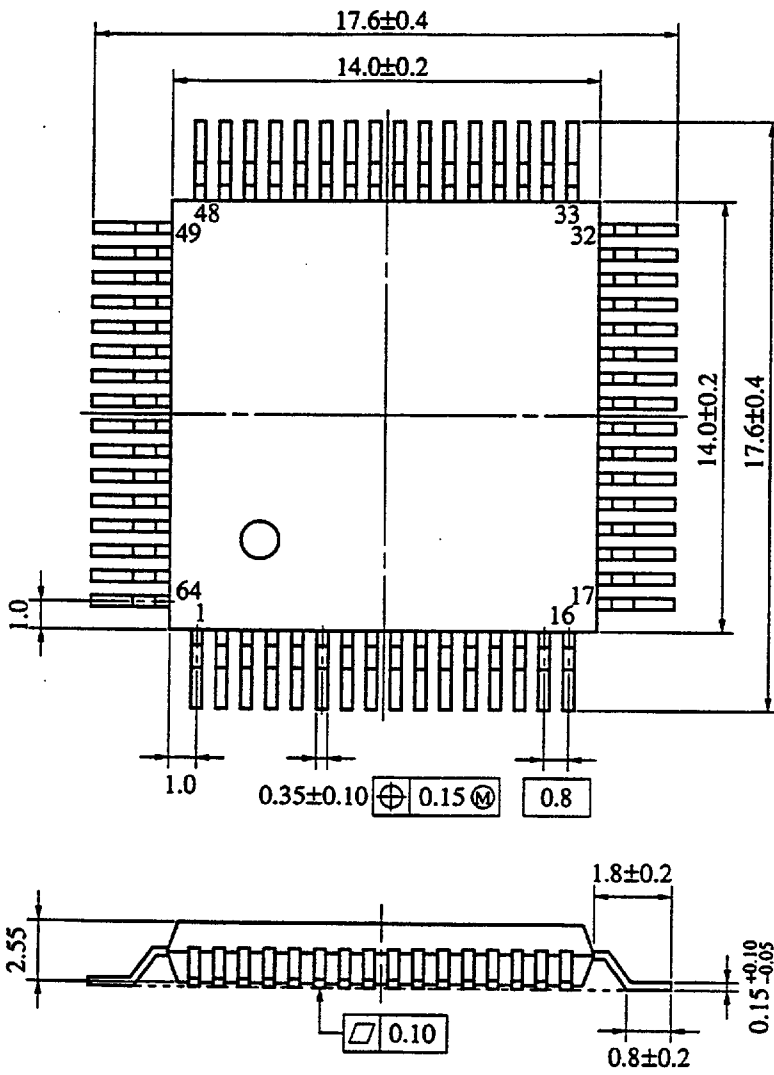

detail of lead end

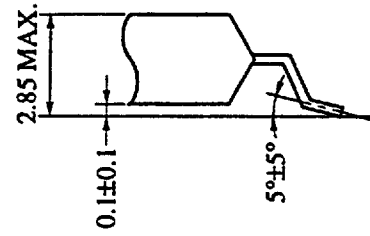

P64GC-80-AB8-3

64-PIN PLASTIC LQFP (12 x 12) (Unit: mm)

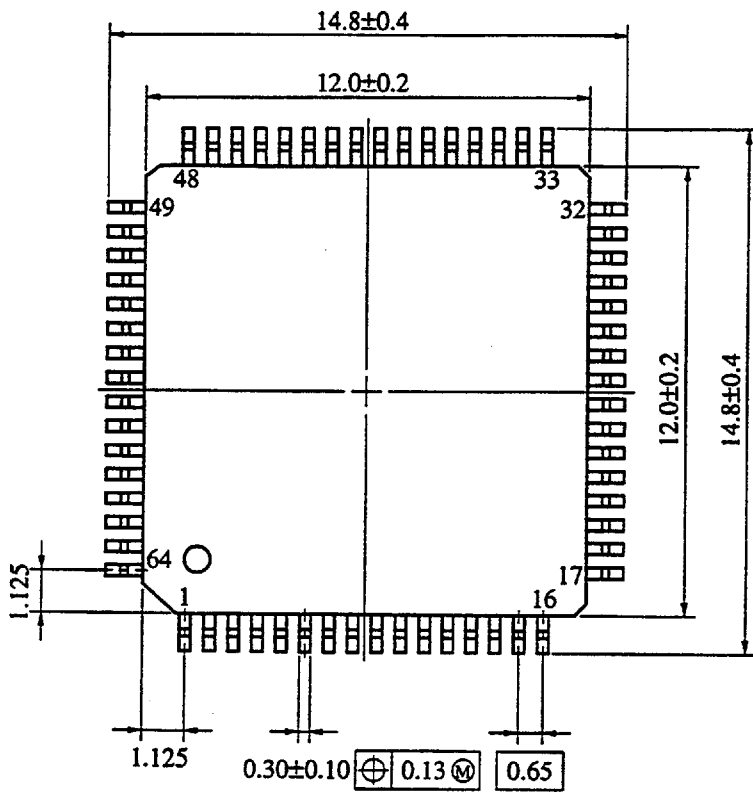

detail of lead end

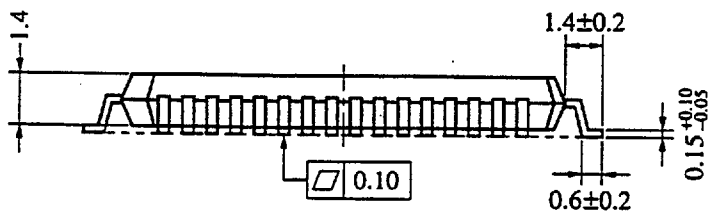
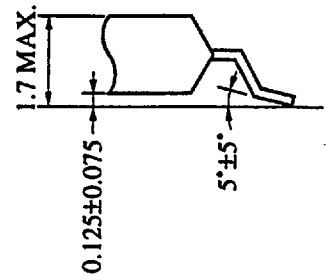

P64GK-65-8A8-1

APPENDIX A. DEVELOPMENT TOOLS

The following development tools are available for system development using the μPD78F0034.

Language Processing Software

RA78K/0 ^{Notes 1, 2, 3, 4}	78K/0 Series common assembler package
CC78K/0 ^{Notes 1, 2, 3, 4}	78K/0 Series common C compiler package
DF780034 ^{Notes 1, 2, 3, 4, 5}	Device file for μPD780034 subseries
CC78K/0-L ^{Notes 1, 2, 3, 4}	78K/0 Series common C compiler library source file

Flash Memory Writing Tools

Flashpro	Dedicated flash writer Product of Naitou Densai Machidaseisakusho Co., Ltd.
PA-FLASH64CW (Tentative name) ^{Note 5}	Adapter for flash writing
PA-FLASH64GC (Tentative name) ^{Note 5}	Product of Naitou Densai Machidaseisakusho Co., Ltd.
PA-FLASH64GK (Tentative name) ^{Note 5}	

Debugging Tool

IE-780000-SL ^{Note 5}	75XL, 78K/0S, 78K/0, and 78K/IV Series common in-circuit emulator
IE-78K0-SL-EM ^{Note 5}	78K/0 Series common CPU core board
IE-78K0-SL-P01 ^{Note 5}	78K/0 Series common emulation board
IE-780034-SL-EM4 ^{Note 5}	Probe board for μPD780034 Subseries emulation
EP-64CW-SL ^{Note 5}	Emulation probe for 64-pin plastic shrink DIP (CW type)
EP-64GC-SL ^{Note 5}	Emulation probe for 64-pin plastic QFP (GC-8A8 type)
EV-9200GC-64	Socket to be mounted on a target system board made for the 64-pin plastic QFP (GC-8A8 type)
EP-64GK-SL ^{Note 5}	Emulation probe for 64-pin plastic LQFP (GK-8A8 type)
TGK-064SBW	Adapter to be mounted on a target system board made for the 64-pin plastic LQFP (GK-8A8 type) Product of Tokyo Eletech Corporation
SM78K0 ^{Notes 5, 6, 7}	78K/0 Series common system simulator
ID78K0 ^{Notes 4, 5, 6, 7}	78K/0 Series common integrated debugger
DF780034 ^{Notes 1, 2, 5, 6, 7, 8}	Device file for μPD780034 Subseries

Real-time OS

RX78K0 ^{Notes 1, 2, 3, 4}	78K/0 series real-time OS
MX78K0 ^{Notes 1, 2, 3, 4}	78K/0 series OS

Fuzzy Inference Development Support System

FE9000 ^{Note 1} /FE9200 ^{Note 8}	Fuzzy knowledge data creation tool
FT9080 ^{Note 1} /FT9085 ^{Note 2}	Translator
FI78K0 ^{Notes 1, 2}	Fuzzy inference module
FD78K0 ^{Notes 1, 2}	Fuzzy inference debugger

- Notes**
1. PC-9800 Series (MS-DOS™) based
 2. IBM PC/AT™ and compatibles (PC DOS™/IBM DOS™/MS-DOS) based
 3. HP9000 Series 300™ (HP-UX™) based
 4. HP9000 Series 700™ (HP-UX) based, SPARCstation™ (SunOS™) based, EWS4800 Series (EWS-UX/V) based
 5. PC-9800 Series (MS-DOS + Windows™) based
 6. IBM PC/AT and compatibles (PC DOS/IBM DOS/MS-DOS + Windows) based
 7. NEWS™ (NEWS-OS™) based
 8. Under development

- Remarks**
1. For third party development tools, refer to the 78K/0 Series Selection Guide (U11126E)
 2. The RA78K/0, CC78K/0, SM78K0, ID78K0, and RX78K/0 are used in combination with the DF780034.

APPENDIX B. RELATED DOCUMENTS

Device Related Documents

Document Name	Document No. (English)	Document No. (Japanese)
μPD780024, 780024Y, 780034, 780034Y Subseries User's Manual	Planned	Planned
μPD78F0034 Preliminary Product Information	This manual	U11860J
78K/0 Series User's Manual Instruction	IEU-1372	IEU-849
78K/0 Series Instruction Table	—	U10903J
78K/0 Series Instruction Set	—	U10904J
μPD780034 Subseries Special Function Register Table	—	Planned

Development Tools Documents (User's Manual)

Document Name	Document No. (English)	Document No. (Japanese)
RA78K Series Assembler Package	Operation	EEU-1399
	Language	EEU-1404
RA78K Series Structured Assembler Preprocessor	EEU-1402	EEU-817
CC78K Series C Compiler	Operation	EEU-1280
	Language	EEU-1284
CC78K/0 C Compiler	Operation	—
	Language	—
CC78K/0 C Compiler Application Note	Programming Know-how	EEA-1208
CC78K Series Library Source File	—	EEU-777
IE-780000-SL	Planned	Planned
IE-78K0-SL-P01	Planned	Planned
IE-780034-SL-EM4	Planned	Planned
EP-64CW-SL	Planned	Planned
EP-64GC-SL	Planned	Planned
EP-64GK-SL	Planned	Planned
SM78K0 System Simulator (Windows Based)	Reference	U10181E
SM78K Series System Simulator	External Parts User Open Interface Specification	U10092E
ID78K0 Integrated Debugger EWS based	Reference	—
ID78K0 Integrated Debugger Windows based	Guide	—
ID78K0 Integrated Debugger PC based	Reference	—

Embedded Software Documents (User's Manual)

Document Name		Document No. (English)	Document No. (Japanese)
78K/0 Series Real Time OS	Basic	—	U11537J
	Installation	—	U11536J
	Technical	—	U11538J
OS for 78K/0 Series MX78K0	Basic	—	EEU-5010
Fuzzy Knowledge Data Creation Tool		EEU-1438	EEU-829
78K/0, 78K/II, 87AD Series Fuzzy Inference Development Support System Translator		EEU-1444	EEU-862
78K/0 Series Fuzzy Inference Development Support System Fuzzy Inference Module		EEU-1441	EEU-858
78K/0 Series Fuzzy Inference Development Support System Fuzzy Inference Debugger		EEU-1458	EEU-921

Other Documents

Document Name	Document No. (English)	Document No. (Japanese)
IC Package Manual	C10943X	
Semiconductor Device Mounting Technology Manual	C10535E	C10535J
Quality Grade on NEC Semiconductor Devices	IEI-1209	C11531J
Reliable Quality Maintenance on NEC Semiconductor Devices	C10983E	C10983J
Electrostatic Discharge (ESD) Test	—	MEM539
Semiconductor Devices Quality Guarantee Guide	MEI-1202	MEI-603
Microcomputer Product Series Guide	—	U11416J

Caution The contents of the above related documents are subject to change without notice. The latest documents should be used for design, etc.

The following supersedes any statement which may be found elsewhere in this document purporting to address the subjects of quality, reliability or suitability of any devices listed in this document for applications other than as noted.

No part of this document may be copied or reproduced in any form or by any means without prior written consent of NEC Electronics Inc. (NECEL). The information in this document is subject to change without notice. ALL DEVICES SOLD BY NECEL ARE COVERED BY THE PROVISIONS APPEARING IN NECEL TERMS AND CONDITIONS OF SALE ONLY, INCLUDING THE LIMITATION OF LIABILITY, WARRANTY, AND PATENT PROVISIONS. NECEL makes no warranty, express, statutory, implied or by description, regarding information set forth herein or regarding the freedom of the described devices from patent infringement. NECEL assumes no responsibility for any errors that may appear in this document. NECEL makes no commitments to update or to keep current information contained in this document. The devices listed in this document are not suitable for use in applications such as, but not limited to, aircraft control systems, aerospace equipment, submarine cables, nuclear reactor control systems and life support systems. "Standard" quality grade devices are recommended for computers, office equipment, communication equipment, test and measurement equipment, machine tools, industrial robots, audio and visual equipment, and other consumer products. For automotive and transportation equipment, traffic control systems, anti-disaster and anti-crime systems, it is recommended that the customer contact the responsible NECEL salesperson to determine the reliability requirements for any such application and any cost adder. NECEL does not recommend or approve use of any of its products in life support devices or systems or in any application where failure could result in injury or death. If customers wish to use NECEL devices in applications not intended by NECEL, customer must contact the responsible NECEL sales people to determine NECEL's willingness to support a given application.

For literature, call toll-free 7 a.m. to 6 p.m. Pacific time: 1-800-366-9782
or FAX your request to: 1-800-729-9288

NOTES FOR CMOS DEVICES

① PRECAUTION AGAINST ESD FOR SEMICONDUCTORS

Note: Strong electric field, when exposed to a MOS device, can cause destruction of the gate oxide and ultimately degrade the device operation. Steps must be taken to stop generation of static electricity as much as possible, and quickly dissipate it once, when it has occurred. Environmental control must be adequate. When it is dry, humidifier should be used. It is recommended to avoid using insulators that easily build static electricity. Semiconductor devices must be stored and transported in an anti-static container, static shielding bag or conductive material. All test and measurement tools including work bench and floor should be grounded. The operator should be grounded using wrist strap. Semiconductor devices must not be touched with bare hands. Similar precautions need to be taken for PW boards with semiconductor devices on it.

② HANDLING OF UNUSED INPUT PINS FOR CMOS

Note: No connection for CMOS device inputs can be cause of malfunction. If no connection is provided to the input pins, it is possible that an internal input level may be generated due to noise, etc., hence causing malfunction. CMOS devices behave differently than Bipolar or NMOS devices. Input levels of CMOS devices must be fixed high or low by using a pull-up or pull-down circuitry. Each unused pin should be connected to V_{DD} or GND with a resistor, if it is considered to have a possibility of being an output pin. All handling related to the unused pins must be judged device by device and related specifications governing the devices.

③ STATUS BEFORE INITIALIZATION OF MOS DEVICES

Note: Power-on does not necessarily define initial status of MOS device. Production process of MOS does not define the initial operation status of the device. Immediately after the power source is turned ON, the devices with reset function have not yet been initialized. Hence, power-on does not guarantee out-pin levels, I/O settings or contents of registers. Device is not initialized until the reset signal is received. Reset operation must be executed immediately after power-on for devices having reset function.