



GaAs INTEGRATED CIRCUIT  
**μPG2179TB**

**L, S-BAND MEDIUM POWER SPDT SWITCH**

**DESCRIPTION**

The μPG2179TB is a GaAs MMIC L, S-band SPDT (Single Pole Double Throw) switch for mobile phone and other L, S-band applications. This device operates with dual control voltages of 2.5 to 5.3 V. This device can operate from 0.05 to

- ★ 3.0 GHz, with low insertion loss and high isolation.

This device is housed in a 6-pin super minimold package, and is suitable for high-density surface mounting.

★ **FEATURES**

- Switch control voltage :  $V_{cont(H)} = 2.5$  to  $5.3$  V (3.0 V TYP.)  
 :  $V_{cont(L)} = -0.2$  to  $+0.2$  V (0 V TYP.)
- Low insertion loss :  $L_{ins1} = 0.25$  dB TYP. @  $f = 0.05$  to  $1.0$  GHz,  $V_{cont(H)} = 3.0$  V,  $V_{cont(L)} = 0$  V  
 :  $L_{ins2} = 0.30$  dB TYP. @  $f = 1.0$  to  $2.0$  GHz,  $V_{cont(H)} = 3.0$  V,  $V_{cont(L)} = 0$  V  
 :  $L_{ins3} = 0.35$  dB TYP. @  $f = 2.0$  to  $2.5$  GHz,  $V_{cont(H)} = 3.0$  V,  $V_{cont(L)} = 0$  V  
 :  $L_{ins4} = 0.40$  dB TYP. @  $f = 2.5$  to  $3.0$  GHz,  $V_{cont(H)} = 3.0$  V,  $V_{cont(L)} = 0$  V
- High isolation :  $ISL1 = 27$  dB TYP. @  $f = 0.05$  to  $2.0$  GHz,  $V_{cont(H)} = 3.0$  V,  $V_{cont(L)} = 0$  V  
 :  $ISL2 = 24$  dB TYP. @  $f = 2.0$  to  $3.0$  GHz,  $V_{cont(H)} = 3.0$  V,  $V_{cont(L)} = 0$  V
- Power handling :  $P_{in(0.1\text{ dB})} = +29.0$  dBm TYP. @  $f = 0.5$  to  $3.0$  GHz,  $V_{cont(H)} = 3.0$  V,  $V_{cont(L)} = 0$  V  
 :  $P_{in(1\text{ dB})} = +32.0$  dBm TYP. @  $f = 0.5$  to  $3.0$  GHz,  $V_{cont(H)} = 3.0$  V,  $V_{cont(L)} = 0$  V
- High-density surface mounting : 6-pin super minimold package ( $2.0 \times 1.25 \times 0.9$  mm)

**APPLICATIONS**

- L, S-band digital cellular or cordless telephone
- PCS, W-LAN, WLL and Bluetooth™ etc.

★ **ORDERING INFORMATION**

Part Number	Package	Marking	Supplying Form
μPG2179TB-E4-A	6-pin super minimold	G4C	<ul style="list-style-type: none"> <li>• Embossed tape 8 mm wide</li> <li>• Pin 4, 5, 6 face the perforation side of the tape</li> <li>• Qty 3 kpcs/reel</li> </ul>

**Remark** To order evaluation samples, contact your nearby sales office.

Part number for sample order: μPG2179TB-A

**Caution** Observe precautions when handling because these devices are sensitive to electrostatic discharge.

The information in this document is subject to change without notice. Before using this document, please confirm that this is the latest version.

**PIN CONNECTIONS AND INTERNAL BLOCK DIAGRAM**

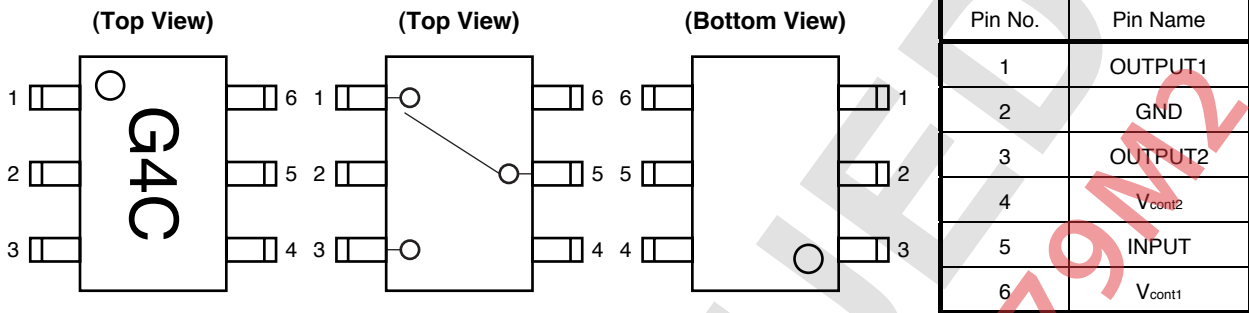

**TRUTH TABLE**

V <sub>cont1</sub>	V <sub>cont2</sub>	INPUT-OUTPUT1	INPUT-OUTPUT2
Low	High	ON	OFF
High	Low	OFF	ON

**ABSOLUTE MAXIMUM RATINGS (T<sub>A</sub> = +25°C, unless otherwise specified)**

Parameter	Symbol	Ratings	Unit
Switch Control Voltage	V <sub>cont</sub>	6.0 <sup>Note</sup>	V
Input Power	P <sub>in</sub>	+33	dBm
Operating Ambient Temperature	T <sub>A</sub>	-45 to +85	°C
Storage Temperature	T <sub>stg</sub>	-55 to +150	°C

★ **Note** |V<sub>cont1</sub> - V<sub>cont2</sub>| ≤ 6.0 V

**RECOMMENDED OPERATING RANGE (T<sub>A</sub> = +25°C, unless otherwise specified)**

Parameter	Symbol	MIN.	TYP.	MAX.	Unit
Switch Control Voltage (H)	V <sub>cont (H)</sub>	2.5	3.0	5.3	V
Switch Control Voltage (L)	V <sub>cont (L)</sub>	-0.2	0	0.2	V

## ★ ELECTRICAL CHARACTERISTICS

(TA = +25°C, V<sub>cont</sub> (H) = 3.0 V, V<sub>cont</sub> (L) = 0 V, DC blocking capacitors = 100 pF, unless otherwise specified)

Parameter	Symbol	Test Conditions	MIN.	TYP.	MAX.	Unit
Insertion Loss 1	L <sub>ins1</sub>	f = 0.05 to 1.0 GHz <sup>Note1</sup>	–	0.25	0.45	dB
Insertion Loss 2	L <sub>ins2</sub>	f = 1.0 to 2.0 GHz	–	0.30	0.50	dB
Insertion Loss 3	L <sub>ins3</sub>	f = 2.0 to 2.5 GHz	–	0.35	0.55	dB
Insertion Loss 4	L <sub>ins4</sub>	f = 2.5 to 3.0 GHz	–	0.40	0.60	dB
Isolation 1	ISL1	f = 0.05 to 2.0 GHz <sup>Note1</sup>	23	27	–	dB
Isolation 2	ISL2	f = 2.0 to 3.0 GHz	20	24	–	dB
Input Return Loss	RL <sub>in</sub>	f = 0.05 to 3.0 GHz <sup>Note1</sup>	15	20	–	dB
Output Return Loss	RL <sub>out</sub>	f = 0.05 to 3.0 GHz <sup>Note1</sup>	15	20	–	dB
0.1 dB Loss Compression Input Power <sup>Note2</sup>	P <sub>in (0.1 dB)</sub>	f = 2.0 GHz	+25.5	+29.0	–	dBm
		f = 2.5 GHz	+25.5	+29.0	–	dBm
		f = 0.5 to 3.0 GHz	–	+29.0	–	dBm
Switch Control Current	I <sub>cont</sub>	No signal	–	4	20	μA
Switch Control Speed	t <sub>sw</sub>	50%CTL to 90/10%RF	–	50	500	ns

**Note1.** DC blocking capacitor = 1 000 pF at f = 0.05 to 0.5 GHz.**2.** P<sub>in (0.1 dB)</sub> is the measured input power level when the insertion loss increases 0.1 dB more than that of linear range.

## ★ STANDARD CHARACTERISTICS FOR REFERENCE

(TA = +25°C, V<sub>cont</sub> (H) = 3.0 V, V<sub>cont</sub> (L) = 0 V, DC blocking capacitors = 100 pF, unless otherwise specified)

Parameter	Symbol	Test Conditions	MIN.	TYP.	MAX.	Unit
1 dB Loss Compression Input Power <sup>Note</sup>	P <sub>in (1 dB)</sub>	f = 0.5 to 3.0 GHz	–	+32.0	–	dBm
3rd Order Intermodulation Intercept Point		f = 0.5 to 3.0 GHz, 2 tone, 5 MHz spicing	–	+60.0	–	dBm

**Note** P<sub>in (1 dB)</sub> is the measured input power level when the insertion loss increases 1 dB more than that of linear range.★ **Caution** When using this IC, a DC coupling capacitor must be externally attached to the I/O pins.

A DC coupling capacitor with a capacitance of 100 pF or lower is recommended when using a frequency of 0.5 GHz or higher, and one with a capacitance of 1,000 pF is recommended when using a frequency of less than 0.5 GHz. The ideal value changes depending on the frequency and bandwidth used, so select a capacitor with a suitable capacitance according to the usage conditions.

★ EVALUATION CIRCUIT

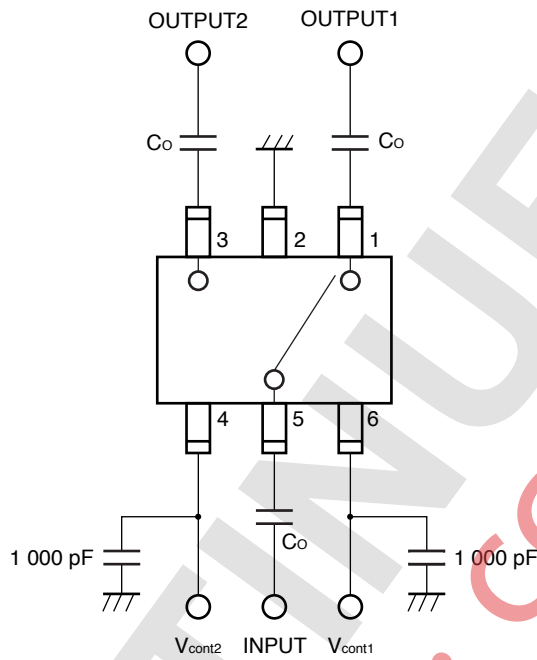

**Remark**  $C_o$  : 0.05 to 0.5 GHz 1 000 pF  
 0.5 to 3.0 GHz 100 pF

The application circuits and their parameters are for reference only and are not intended for use in actual design-ins.

★ ILLUSTRATION OF THE TEST CIRCUIT ASSEMBLED ON EVALUATION BOARD

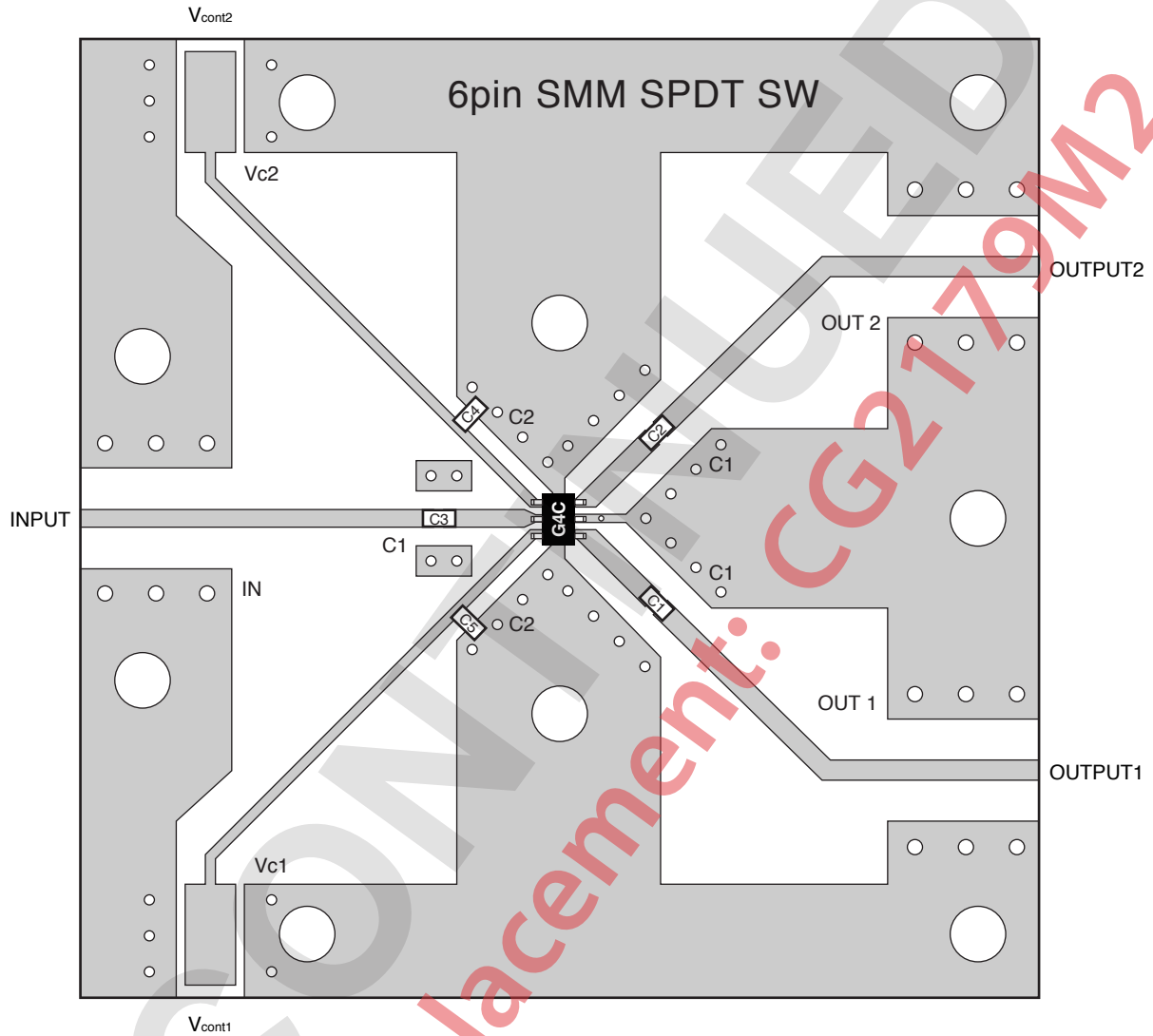

USING THE NEC EVALUATION BOARD

Symbol	Values
C1, C2, C3	100 pF
C4, C5	1 000 pF

**TYPICAL CHARACTERISTICS**

★ (TA = +25°C, Vcont (H) = 3.0 V, Vcont (L) = 0 V, DC blocking capacitors = 100 pF, unless otherwise specified)

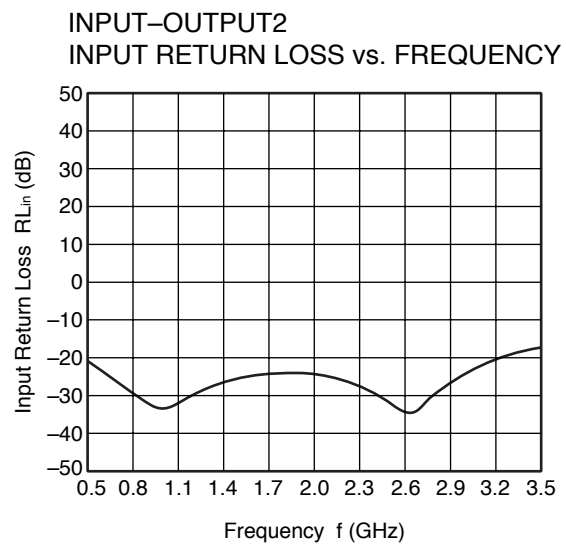
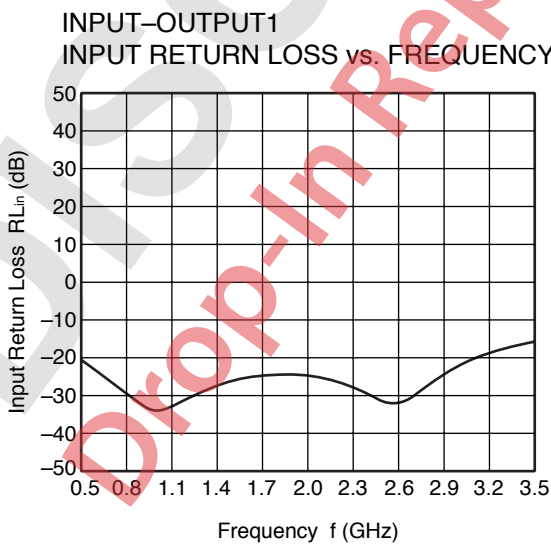
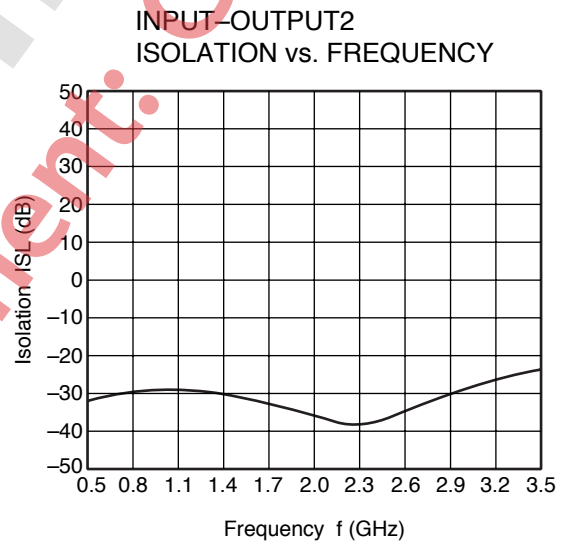
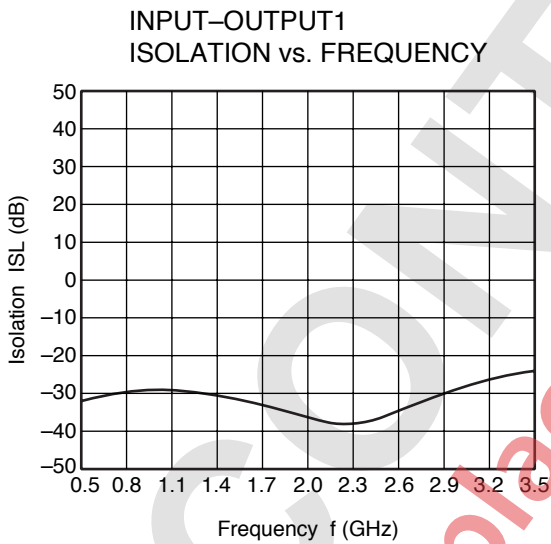
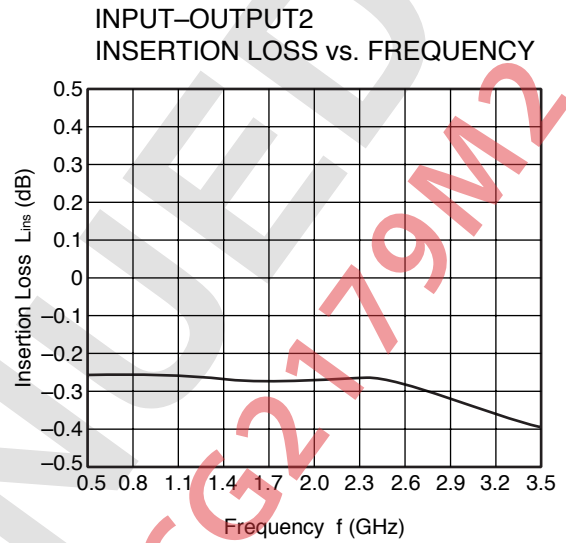
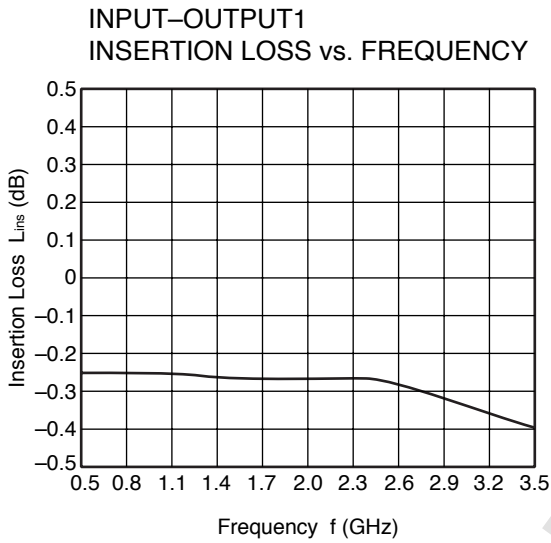

**Remark** The graphs indicate nominal characteristics.

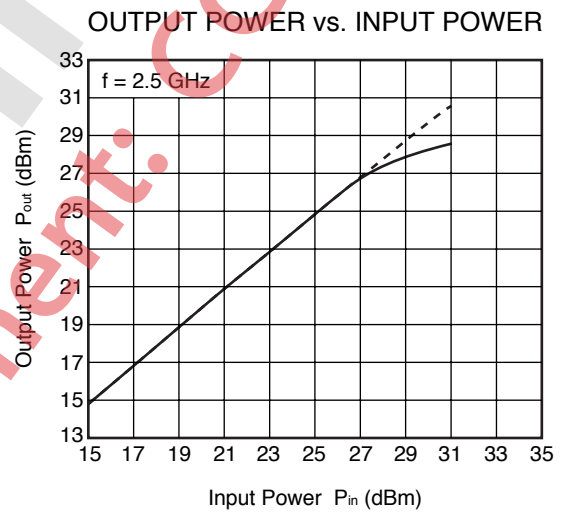
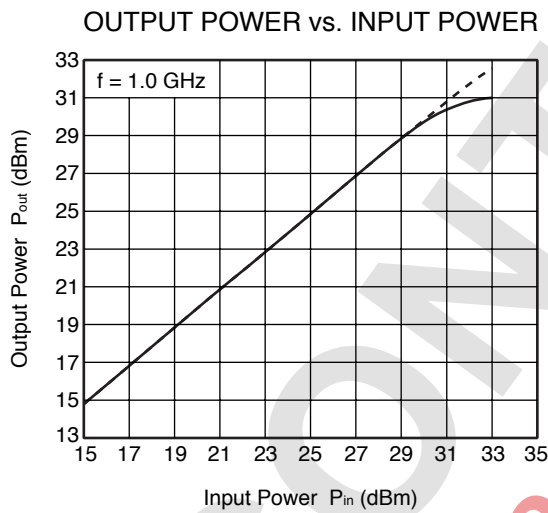
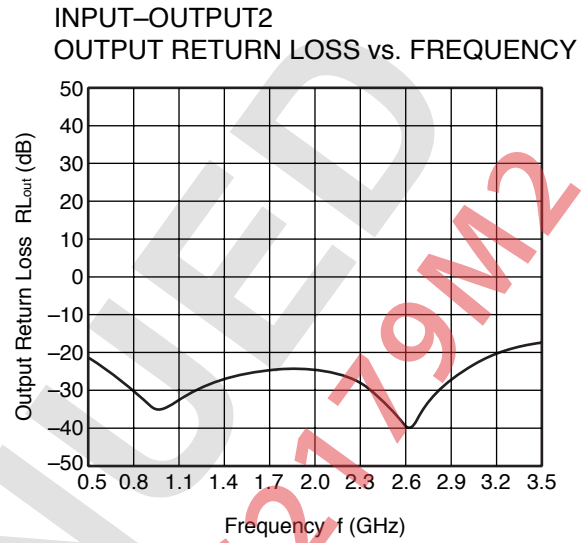
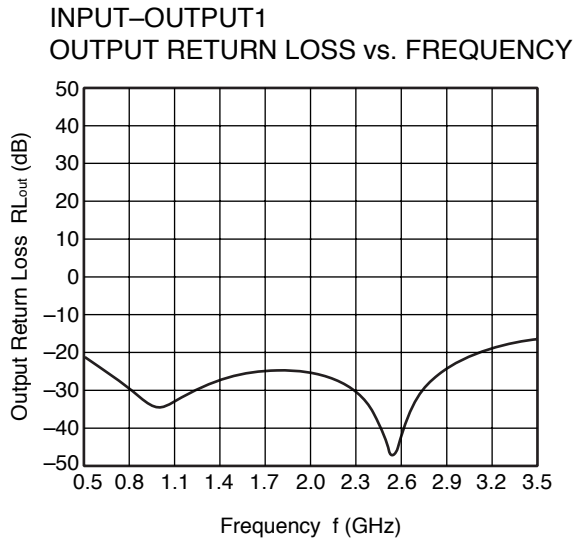

**Remark** The graphs indicate nominal characteristics.

PACKAGE DIMENSIONS

6-PIN SUPER MINIMOLD (UNIT: mm)

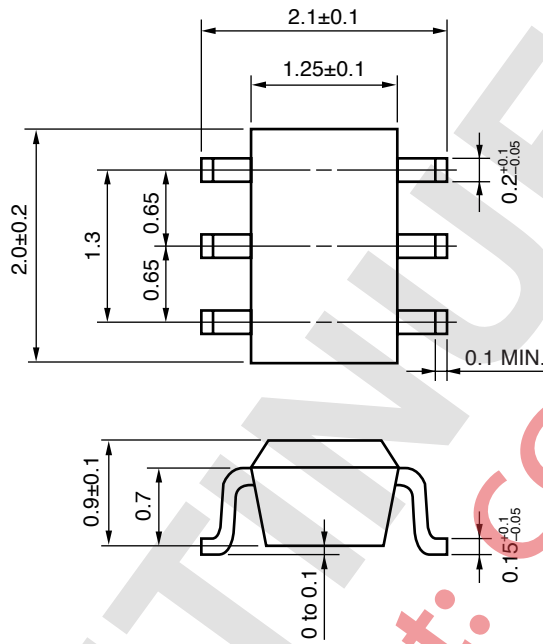



**RECOMMENDED SOLDERING CONDITIONS**

This product should be soldered and mounted under the following recommended conditions. For soldering methods and conditions other than those recommended below, contact your nearby sales office.

Soldering Method	Soldering Conditions	Condition Symbol
Infrared Reflow	Peak temperature (package surface temperature) : 260°C or below Time at peak temperature : 10 seconds or less Time at temperature of 220°C or higher : 60 seconds or less Preheating time at 120 to 180°C : 120±30 seconds Maximum number of reflow processes : 3 times Maximum chlorine content of rosin flux (% mass) : 0.2%(Wt.) or below	IR260
VPS	Peak temperature (package surface temperature) : 215°C or below Time at temperature of 200°C or higher : 25 to 40 seconds Preheating time at 120 to 150°C : 30 to 60 seconds Maximum number of reflow processes : 3 times Maximum chlorine content of rosin flux (% mass) : 0.2%(Wt.) or below	VP215
Wave Soldering	Peak temperature (molten solder temperature) : 260°C or below Time at peak temperature : 10 seconds or less Preheating temperature (package surface temperature) : 120°C or below Maximum number of flow processes : 1 time Maximum chlorine content of rosin flux (% mass) : 0.2%(Wt.) or below	WS260
Partial Heating	Peak temperature (pin temperature) : 350°C or below Soldering time (per side of device) : 3 seconds or less Maximum chlorine content of rosin flux (% mass) : 0.2%(Wt.) or below	HS350

**Caution** Do not use different soldering methods together (except for partial heating).

Bluetooth is a trademark owned by Bluetooth SIG, Inc., U.S.A.

- **The information in this document is current as of March, 2004. The information is subject to change without notice. For actual design-in, refer to the latest publications of NEC's data sheets or data books, etc., for the most up-to-date specifications of NEC semiconductor products. Not all products and/or types are available in every country. Please check with an NEC sales representative for availability and additional information.**
- No part of this document may be copied or reproduced in any form or by any means without prior written consent of NEC. NEC assumes no responsibility for any errors that may appear in this document.
- NEC does not assume any liability for infringement of patents, copyrights or other intellectual property rights of third parties by or arising from the use of NEC semiconductor products listed in this document or any other liability arising from the use of such products. No license, express, implied or otherwise, is granted under any patents, copyrights or other intellectual property rights of NEC or others.
- Descriptions of circuits, software and other related information in this document are provided for illustrative purposes in semiconductor product operation and application examples. The incorporation of these circuits, software and information in the design of customer's equipment shall be done under the full responsibility of customer. NEC assumes no responsibility for any losses incurred by customers or third parties arising from the use of these circuits, software and information.
- While NEC endeavours to enhance the quality, reliability and safety of NEC semiconductor products, customers agree and acknowledge that the possibility of defects thereof cannot be eliminated entirely. To minimize risks of damage to property or injury (including death) to persons arising from defects in NEC semiconductor products, customers must incorporate sufficient safety measures in their design, such as redundancy, fire-containment, and anti-failure features.
- NEC semiconductor products are classified into the following three quality grades:  
"Standard", "Special" and "Specific". The "Specific" quality grade applies only to semiconductor products developed based on a customer-designated "quality assurance program" for a specific application. The recommended applications of a semiconductor product depend on its quality grade, as indicated below. Customers must check the quality grade of each semiconductor product before using it in a particular application.  
"Standard": Computers, office equipment, communications equipment, test and measurement equipment, audio and visual equipment, home electronic appliances, machine tools, personal electronic equipment and industrial robots  
"Special": Transportation equipment (automobiles, trains, ships, etc.), traffic control systems, anti-disaster systems, anti-crime systems, safety equipment and medical equipment (not specifically designed for life support)  
"Specific": Aircraft, aerospace equipment, submersible repeaters, nuclear reactor control systems, life support systems and medical equipment for life support, etc.  
The quality grade of NEC semiconductor products is "Standard" unless otherwise expressly specified in NEC's data sheets or data books, etc. If customers wish to use NEC semiconductor products in applications not intended by NEC, they must contact an NEC sales representative in advance to determine NEC's willingness to support a given application.  
(Note)  
(1) "NEC" as used in this statement means NEC Corporation, NEC Compound Semiconductor Devices, Ltd. and also includes its majority-owned subsidiaries.  
(2) "NEC semiconductor products" means any semiconductor product developed or manufactured by or for NEC (as defined above).

M8E 00.4-0110

<b>Caution</b>	GaAs Products	<p>This product uses gallium arsenide (GaAs). GaAs vapor and powder are hazardous to human health if inhaled or ingested, so please observe the following points.</p> <ul style="list-style-type: none"><li>• Follow related laws and ordinances when disposing of the product. If there are no applicable laws and/or ordinances, dispose of the product as recommended below.</li></ul> <ol style="list-style-type: none"><li>1. Commission a disposal company able to (with a license to) collect, transport and dispose of materials that contain arsenic and other such industrial waste materials.</li><li>2. Exclude the product from general industrial waste and household garbage, and ensure that the product is controlled (as industrial waste subject to special control) up until final disposal.</li></ol> <ul style="list-style-type: none"><li>• Do not burn, destroy, cut, crush, or chemically dissolve the product.</li><li>• Do not lick the product or in any way allow it to enter the mouth.</li></ul>
----------------	---------------	---

DISCONTINUING  
Drop-In Replacement: CG2179M2

## NOTICE

1. Descriptions of circuits, software and other related information in this document are provided only to illustrate the operation of semiconductor products and application examples. You are fully responsible for the incorporation of these circuits, software, and information in the design of your equipment. California Eastern Laboratories and Renesas Electronics assumes no responsibility for any losses incurred by you or third parties arising from the use of these circuits, software, or information.
2. California Eastern Laboratories has used reasonable care in preparing the information included in this document, but California Eastern Laboratories does not warrant that such information is error free. California Eastern Laboratories and Renesas Electronics assumes no liability whatsoever for any damages incurred by you resulting from errors in or omissions from the information included herein.
3. California Eastern Laboratories and Renesas Electronics do not assume any liability for infringement of patents, copyrights, or other intellectual property rights of third parties by or arising from the use of Renesas Electronics products or technical information described in this document. No license, express, implied or otherwise, is granted hereby under any patents, copyrights or other intellectual property rights of California Eastern Laboratories or Renesas Electronics or others.
4. You should not alter, modify, copy, or otherwise misappropriate any Renesas Electronics product, whether in whole or in part. California Eastern Laboratories and Renesas Electronics assume no responsibility for any losses incurred by you or third parties arising from such alteration, modification, copy or otherwise misappropriation of Renesas Electronics product.
5. Renesas Electronics products are classified according to the following two quality grades: "Standard" and "High Quality". The recommended applications for each Renesas Electronics product depends on the product's quality grade, as indicated below. "Standard": Computers; office equipment; communications equipment; test and measurement equipment; audio and visual equipment; home electronic appliances; machine tools; personal electronic equipment; and industrial robots etc. "High Quality": Transportation equipment (automobiles, trains, ships, etc.); traffic control systems; anti-disaster systems; anti-crime systems; and safety equipment etc. Renesas Electronics products are neither intended nor authorized for use in products or systems that may pose a direct threat to human life or bodily injury (artificial life support devices or systems, surgical implantations etc.), or may cause serious property damages (nuclear reactor control systems, military equipment etc.). You must check the quality grade of each Renesas Electronics product before using it in a particular application. You may not use any Renesas Electronics product for any application for which it is not intended. California Eastern Laboratories and Renesas Electronics shall not be in any way liable for any damages or losses incurred by you or third parties arising from the use of any Renesas Electronics product for which the product is not intended by California Eastern Laboratories or Renesas Electronics.
6. You should use the Renesas Electronics products described in this document within the range specified by California Eastern Laboratories, especially with respect to the maximum rating, operating supply voltage range, movement power voltage range, heat radiation characteristics, installation and other product characteristics. California Eastern Laboratories shall have no liability for malfunctions or damages arising out of the use of Renesas Electronics products beyond such specified ranges.
7. Although Renesas Electronics endeavors to improve the quality and reliability of its products, semiconductor products have specific characteristics such as the occurrence of failure at a certain rate and malfunctions under certain use conditions. Further, Renesas Electronics products are not subject to radiation resistance design. Please be sure to implement safety measures to guard them against the possibility of physical injury, and injury or damage caused by fire in the event of the failure of a Renesas Electronics product, such as safety design for hardware and software including but not limited to redundancy, fire control and malfunction prevention, appropriate treatment for aging degradation or any other appropriate measures. Because the evaluation of microcomputer software alone is very difficult, please evaluate the safety of the final products or systems manufactured by you.
8. Please contact a California Eastern Laboratories sales office for details as to environmental matters such as the environmental compatibility of each Renesas Electronics product. Please use Renesas Electronics products in compliance with all applicable laws and regulations that regulate the inclusion or use of controlled substances, including without limitation, the EU RoHS Directive. California Eastern Laboratories and Renesas Electronics assume no liability for damages or losses occurring as a result of your noncompliance with applicable laws and regulations.
9. Renesas Electronics products and technology may not be used for or incorporated into any products or systems whose manufacture, use, or sale is prohibited under any applicable domestic or foreign laws or regulations. You should not use Renesas Electronics products or technology described in this document for any purpose relating to military applications or use by the military, including but not limited to the development of weapons of mass destruction. When exporting the Renesas Electronics products or technology described in this document, you should comply with the applicable export control laws and regulations and follow the procedures required by such laws and regulations.
10. It is the responsibility of the buyer or distributor of California Eastern Laboratories, who distributes, disposes of, or otherwise places the Renesas Electronics product with a third party, to notify such third party in advance of the contents and conditions set forth in this document, California Eastern Laboratories and Renesas Electronics assume no responsibility for any losses incurred by you or third parties as a result of unauthorized use of Renesas Electronics products.
11. This document may not be reproduced or duplicated in any form, in whole or in part, without prior written consent of California Eastern Laboratories.
12. Please contact a California Eastern Laboratories sales office if you have any questions regarding the information contained in this document or Renesas Electronics products, or if you have any other inquiries.

**NOTE 1:** "Renesas Electronics" as used in this document means Renesas Electronics Corporation and also includes its majority-owned subsidiaries.

**NOTE 2:** "Renesas Electronics product(s)" means any product developed or manufactured by or for Renesas Electronics.

**NOTE 3:** Products and product information are subject to change without notice.

**CEL Headquarters** • 4590 Patrick Henry Drive, Santa Clara, CA 95054 • Phone (408) 919-2500 • [www.cel.com](http://www.cel.com)

For a complete list of sales offices, representatives and distributors,  
Please visit our website: [www.cel.com/contactus](http://www.cel.com/contactus)