

POWER AMPLIFIER FOR Bluetooth™ Class 1

DESCRIPTION

The μ PG2314T5N is GaAs HBT MMIC for power amplifier which was developed for Bluetooth Class 1.

This device realizes high efficiency, high gain and high output power by using InGaP HBT. This device is housed in a 6-pin plastic TSON (Thin Small Out-line Non-leded) package. And this package is able to high-density surface mounting.

FEATURES

- Operation frequency : $f_{opt} = 2\ 400$ to $2\ 500$ MHz (2 450 MHz TYP.)
- Supply voltage : $V_{cc1, 2} = 2.7$ to 3.6 V (3.0 V TYP.)
- Control voltage : $V_{cont} = 0$ to 3.6 V (3.0 V TYP.)
: $V_{bias} + V_{enable} = 0$ to 3.1 V (3.0 V TYP.)
- Circuit current : $I_{cc} = 65$ mA TYP. @ $V_{cc1, 2} = 3.0$ V, $V_{bias} + V_{enable} = 3.0$ V, $V_{cont} = 3.0$ V,
 $P_{in} = 0$ dBm
- Output power : $P_{out} = +20$ dBm TYP. @ $V_{cc1, 2} = 3.0$ V, $V_{bias} + V_{enable} = 3.0$ V, $V_{cont} = 3.0$ V,
 $P_{in} = 0$ dBm
- Gain control range : GCR = 23 dB TYP. @ $V_{cc1, 2} = 3.0$ V, $V_{bias} + V_{enable} = 3.0$ V, $V_{cont} = 0$ to 3.0 V,
 $P_{in} = 0$ dBm
- High efficiency : PAE = 50% TYP.
- High-density surface mounting : 6-pin plastic TSON package ($1.5 \times 1.5 \times 0.37$ mm)

APPLICATIONS

- Power Amplifier for Bluetooth Class 1

ORDERING INFORMATION

Part Number	Order Number	Package	Marking	Supplying Form
μ PG2314T5N-E2	μ PG2314T5N-E2-A	6-pin plastic TSON (Pb-Free)	G5D	<ul style="list-style-type: none"> • Embossed tape 8 mm wide • Pin 1, 6 face the perforation side of the tape • Qty 3 kpcs/reel

Remark To order evaluation samples, contact your nearby sales office.

Part number for sample order: μ PG2314T5N-A

Caution: Observe precautions when handling because these devices are sensitive to electrostatic discharge

The information in this document is subject to change without notice. Before using this document, please confirm that this is the latest version.

PIN CONNECTIONS AND INTERNAL BLOCK DIAGRAM

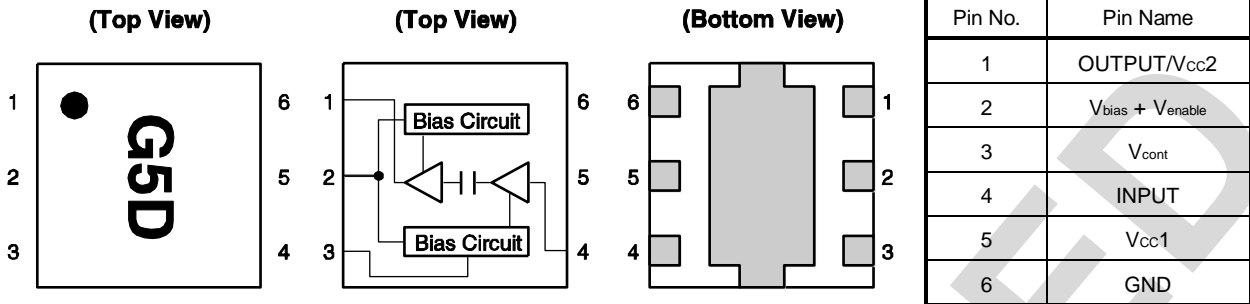

Remark Exposed pad : GND

ABSOLUTE MAXIMUM RATINGS (T_A = +25°C, unless otherwise specified)

Parameter	Symbol	Ratings	Unit
Supply Voltage	V _{cc1, 2}	5.5	V
	V _{bias} + V _{enable}	3.6	V
Control Voltage	V _{cont}	3.6	V
Circuit Current	I _{cc}	400	mA
Control Current	I _{cont}	0.5	mA
Input Power	P _{in}	+10	dBm
Power Dissipation	P _D	700 ^{Note}	mW
Operating Ambient Temperature	T _A	-40 to +85	°C
Storage Temperature	T _{stg}	-55 to +150	°C

Note Mounted on double-sided copper-clad 50 × 50 × 1.6 mm epoxy glass PWB, T_A = +85°C

RECOMMENDED OPERATING RANGE (T_A = +25°C, unless otherwise specified)

Parameter	Symbol	MIN.	TYP.	MAX.	Unit
Operating Frequency	f _{opt}	2 400	2 450	2 500	MHz
Supply Voltage	V _{cc1, 2}	2.7	3.0	3.6	V
	V _{bias} + V _{enable}	0	3.0	3.1	V
Control Voltage	V _{cont}	0	3.0	3.6	V

ELECTRICAL CHARACTERISTICS

($T_A = +25^\circ\text{C}$, $V_{CC1, 2} = V_{\text{bias}} + V_{\text{enable}} = 3.0\text{ V}$, $f = 2\ 450\text{ MHz}$, $P_{\text{out}} = +20\text{ dBm}$, External input and output matching, unless otherwise specified)

Parameter	Symbol	Test Conditions	MIN.	TYP.	MAX.	Unit
Circuit Current	I_{CC}	$V_{\text{cont}} = 3.0\text{ V}$, $P_{\text{in}} = 0\text{ dBm}$	–	65	70	mA
Shut Down Current	$I_{\text{shut down}}$	$V_{\text{cont}} = 3.0\text{ V}$, $P_{\text{in}} = 0\text{ dBm}$, $V_{\text{bias}} + V_{\text{enable}} = 0\text{ V}$	–	0	1	μA
Output Power 1	P_{out1}	$V_{\text{cont}} = 3.0\text{ V}$, $P_{\text{in}} = 0\text{ dBm}$	+18.0	+20.0	–	dBm
Output Power 2	P_{out2}	$V_{\text{cont}} = 0\text{ V}$, $P_{\text{in}} = 0\text{ dBm}$	–	–3.0	+1.0	dBm
Gain Control Range	GCR	$V_{\text{cont}} = 0\text{ to }3.0\text{ V}$, $P_{\text{in}} = 0\text{ dBm}$	17	23	–	dB
Efficiency	PAE	$V_{\text{cont}} = 3.0\text{ V}$, $P_{\text{in}} = 0\text{ dBm}$	–	50	–	%

DISCONTINUED

EVALUATION CIRCUIT

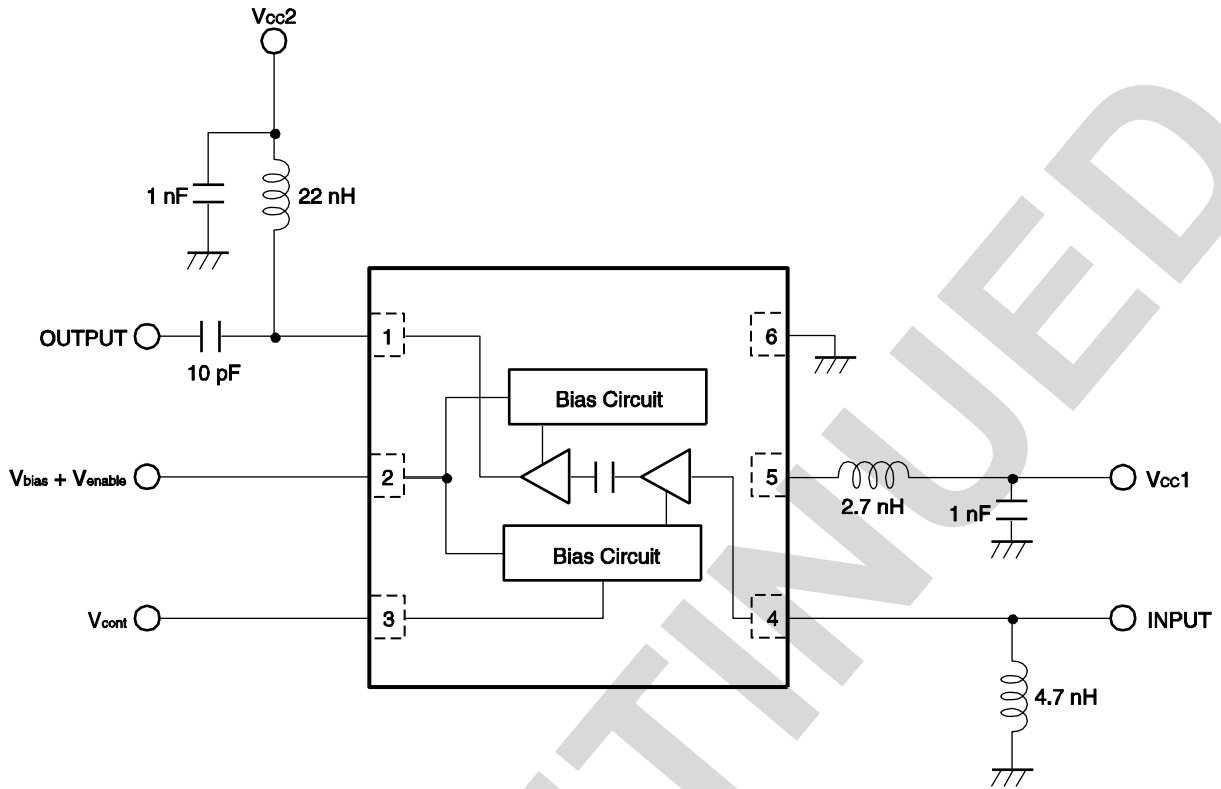

The application circuits and their parameters are for reference only and are not intended for use in actual design-ins.

TYPICAL CHARACTERISTICS ($T_A = +25^\circ\text{C}$, unless otherwise specified)

Condition : $f = 2\,450\text{ MHz}$, $V_{cc1} = V_{cc2} = V_{bias} + V_{enable} = V_{cont} = 3.0\text{ V}$, with external input and output matching circuit

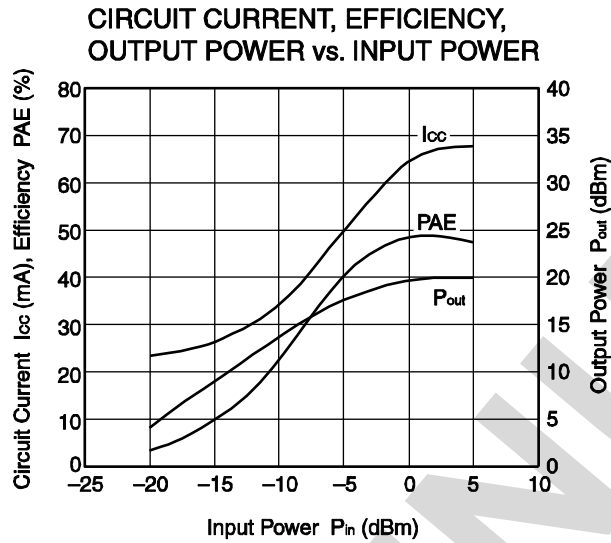

Condition : $f = 2\,450\text{ MHz}$, $V_{cc1} = V_{cc2} = V_{bias} + V_{enable} = 3.0\text{ V}$, $P_{in} = 0\text{ dBm}$, with external input and output matching circuit

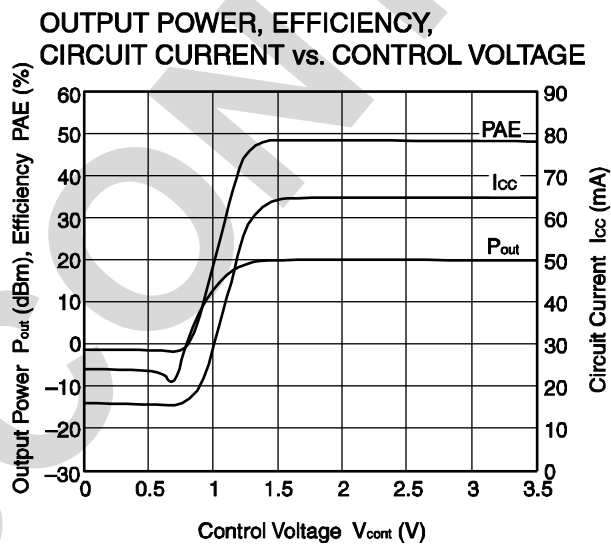

Remark The graphs indicate nominal characteristics.

Condition : $f = 2.450$ MHz, $V_{cc1} = V_{cc2} = V_{cont} = 3.0$ V, $P_{in} = 0$ dBm, with external input and output matching circuit

OUTPUT POWER, $2f_0$, CIRCUIT CURRENT, EFFICIENCY vs. SUPPLY VOLTAGE

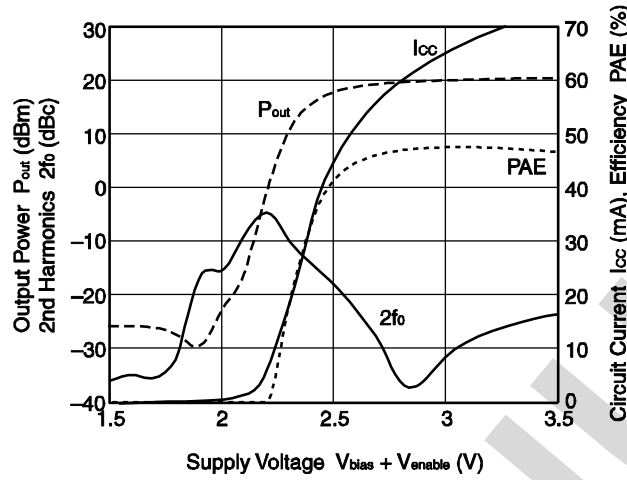

Condition : $V_{cc1} = V_{cc2} = V_{bias} + V_{enable} = V_{cont} = 3.0$ V, $P_{in} = -20$ dBm, with external input and output matching circuit

S11-FREQUENCY

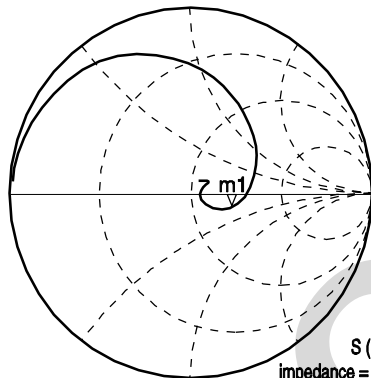

START 50.000 000 MHz STOP 6 050.000 000 MHz

S11, S22-FREQUENCY

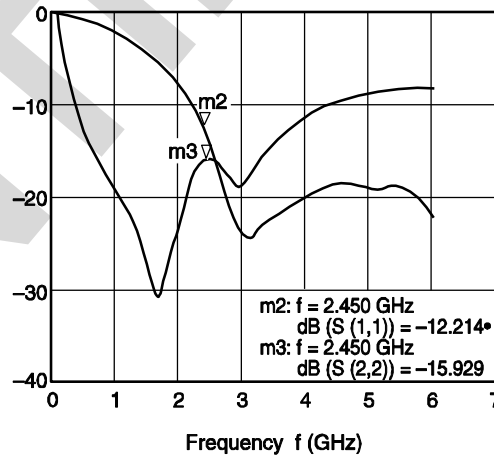

S21-FREQUENCY

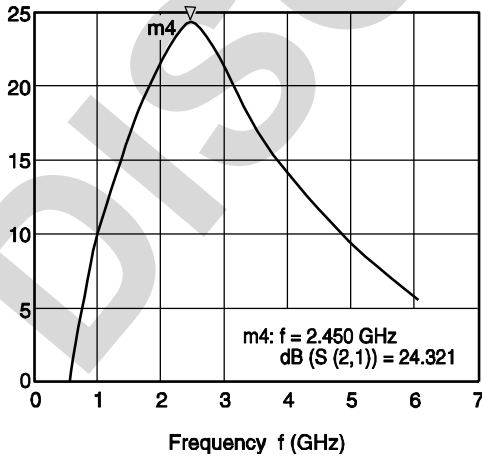

S22-FREQUENCY

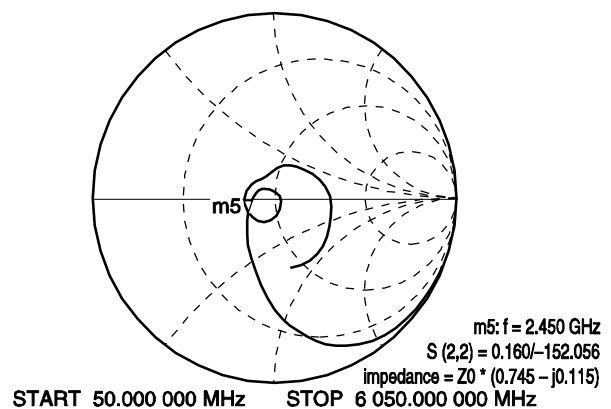

Remark The graphs indicate nominal characteristics.

MOUNTING PAD AND SOLDER MASK LAYOUT DIMENSIONS

6-PIN PLASTIC TSON (UNIT: mm)

MOUNTING PAD

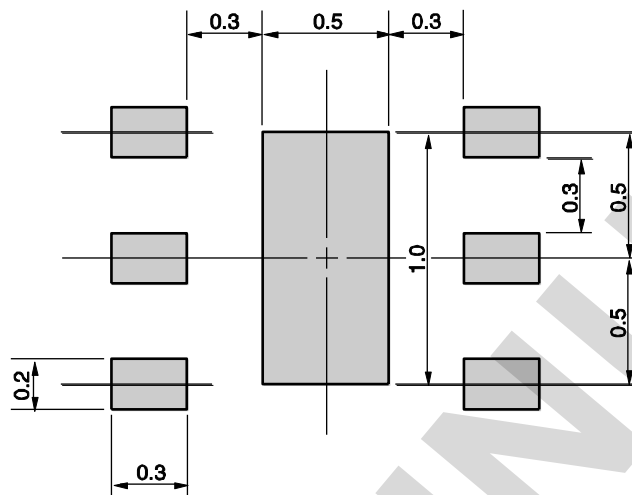

SOLDER MASK

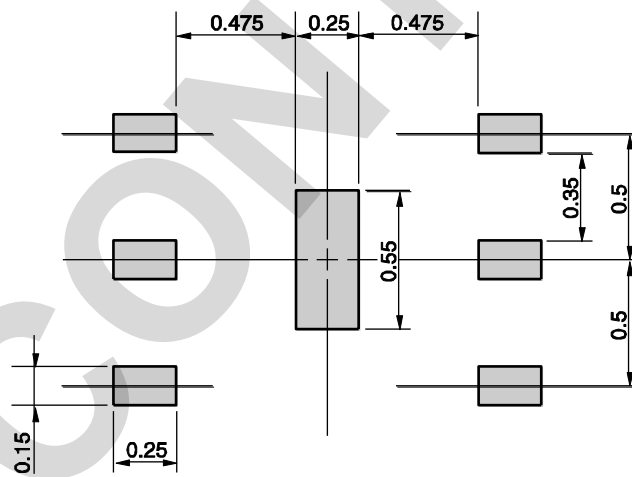

Solder thickness : 0.08 mm

Remark The mounting pad and solder mask layouts in this document are for reference only.

<R> PACKAGE DIMENSIONS

6-PIN PLASTIC TSON (UNIT: mm)

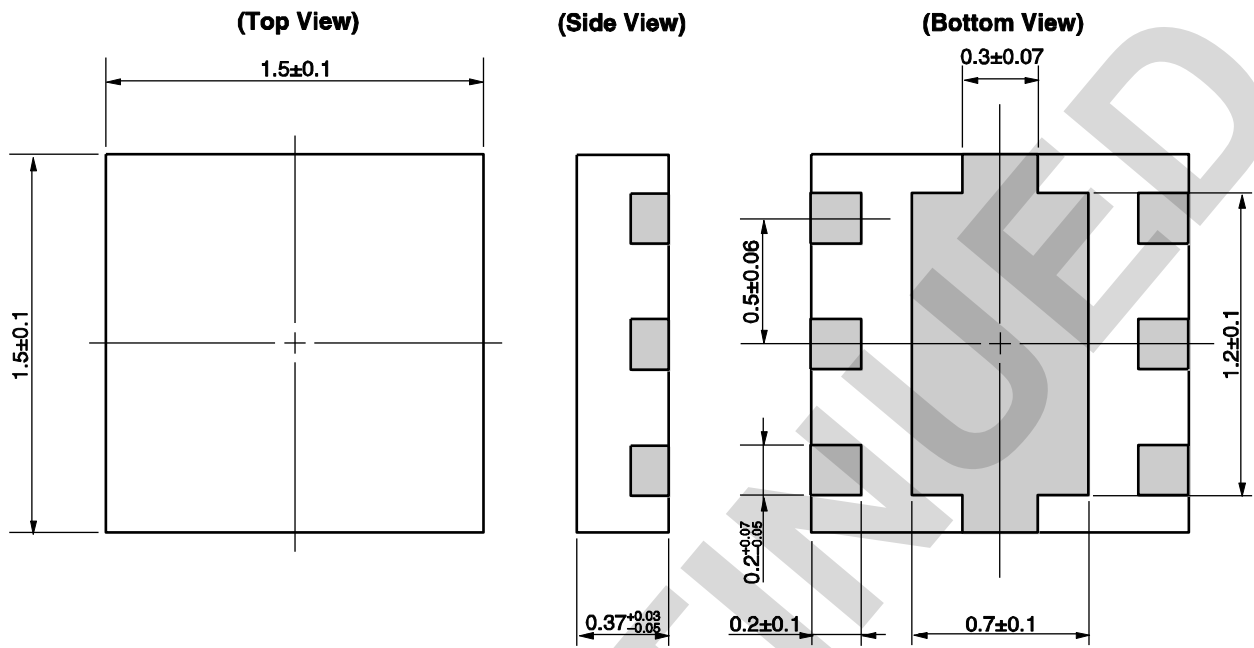

RECOMMENDED SOLDERING CONDITIONS

This product should be soldered and mounted under the following recommended conditions. For soldering methods and conditions other than those recommended below, contact your nearby sales office.

Soldering Method	Soldering Conditions	Condition Symbol
Infrared Reflow	Peak temperature (package surface temperature) : 260°C or below Time at peak temperature : 10 seconds or less Time at temperature of 220°C or higher : 60 seconds or less Preheating time at 120 to 180°C : 120±30 seconds Maximum number of reflow processes : 3 times Maximum chlorine content of rosin flux (% mass) : 0.2%(Wt.) or below	IR260
Wave Soldering	Peak temperature (molten solder temperature) : 260°C or below Time at peak temperature : 10 seconds or less Preheating temperature (package surface temperature) : 120°C or below Maximum number of flow processes : 1 time Maximum chlorine content of rosin flux (% mass) : 0.2%(Wt.) or below	WS260
Partial Heating	Peak temperature (terminal temperature) : 350°C or below Soldering time (per side of device) : 3 seconds or less Maximum chlorine content of rosin flux (% mass) : 0.2%(Wt.) or below	HS350

Caution Do not use different soldering methods together (except for partial heating).

DISCONTINUED

<p>Caution</p>	<p>GaAs Products</p>	<p>This product uses gallium arsenide (GaAs). GaAs vapor and powder are hazardous to human health if inhaled or ingested, so please observe the following points.</p> <ul style="list-style-type: none"> • Follow related laws and ordinances when disposing of the product. If there are no applicable laws and/or ordinances, dispose of the product as recommended below. <ol style="list-style-type: none"> 1. Commission a disposal company able to (with a license to) collect, transport and dispose of materials that contain arsenic and other such industrial waste materials. 2. Exclude the product from general industrial waste and household garbage, and ensure that the product is controlled (as industrial waste subject to special control) up until final disposal. <ul style="list-style-type: none"> • Do not burn, destroy, cut, crush, or chemically dissolve the product. • Do not lick the product or in any way allow it to enter the mouth.
-----------------------	----------------------	---

DISCONTINUED