

# DATA SHEET

www.DataSheet4U.com

# NEC

## GaAs INTEGRATED CIRCUIT $\mu$ PG2406TB

### 0.01 to 3.0 GHz SPDT SWITCH

#### DESCRIPTION

The  $\mu$ PG2406TB is a GaAs MMIC for L, S-band SPDT (Single Pole Double Throw) switch which were designed for mobile phone and another L, S-band application.

This device can operate 2 control switching by control voltage 1.8 to 5.3 V. This device can operate frequency from 0.01 to 3.0 GHz, having the low insertion loss and high isolation.

This device is housed in a 6-pin super minimold package. And this package is able to high-density surface mounting.

#### FEATURES

- Switch control voltage :  $V_{\text{cont (H)}} = 1.8$  to  $5.3$  V (2.7 V TYP.)  
:  $V_{\text{cont (L)}} = -0.2$  to  $+0.2$  V (0 V TYP.)
- Low insertion loss :  $L_{\text{ins}} = 0.40$  dB TYP. @  $f = 1.0$  GHz,  $V_{\text{cont (H)}} = 2.7$  V,  $V_{\text{cont (L)}} = 0$  V  
:  $L_{\text{ins}} = 0.47$  dB TYP. @  $f = 2.5$  GHz,  $V_{\text{cont (H)}} = 2.7$  V,  $V_{\text{cont (L)}} = 0$  V
- High isolation :  $ISL = 27$  dB TYP. @  $f = 1.0$  GHz,  $V_{\text{cont (H)}} = 2.7$  V,  $V_{\text{cont (L)}} = 0$  V  
:  $ISL = 17$  dB TYP. @  $f = 2.5$  GHz,  $V_{\text{cont (H)}} = 2.7$  V,  $V_{\text{cont (L)}} = 0$  V
- Handling power :  $P_{\text{in (0.1 dB)}} = +29.0$  dBm TYP. @  $f = 2.0/2.5$  GHz,  $V_{\text{cont (H)}} = 2.7$  V,  $V_{\text{cont (L)}} = 0$  V  
:  $P_{\text{in (1 dB)}} = +30.5$  dBm TYP. @  $f = 0.5$  to  $3.0$  GHz,  $V_{\text{cont (H)}} = 2.7$  V,  $V_{\text{cont (L)}} = 0$  V
- High-density surface mounting : 6-pin super minimold package ( $2.0 \times 1.25 \times 0.9$  mm)

#### APPLICATIONS

- L, S-band digital cellular or cordless telephone
- W-LAN, WLL and Bluetooth™ etc.

#### ORDERING INFORMATION

Part Number	Order Number	Package	Marking	Supplying Form
$\mu$ PG2406TB-E4	$\mu$ PG2406TB-E4-A	6-pin super minimold (Pb-Free)	G5L	<ul style="list-style-type: none"><li>• Embossed tape 8 mm wide</li><li>• Pin 4, 5, 6 face the perforation side of the tape</li><li>• Qty 3 kpcs/reel</li></ul>

**Remark** To order evaluation samples, contact your nearby sales office.

Part number for sample order:  $\mu$ PG2406TB

**Caution** Although this device is designed to be as robust as possible, ESD (Electrostatic Discharge) can damage this device. This device must be protected at all times from ESD. Static charges may easily produce potentials of several kilovolts on the human body or equipment, which can discharge without detection. Industry-standard ESD precautions must be employed at all times.

The information in this document is subject to change without notice. Before using this document, please confirm that this is the latest version.  
Not all products and/or types are available in every country. Please check with an NEC Electronics sales representative for availability and additional information.

**PIN CONNECTIONS AND INTERNAL BLOCK DIAGRAM**

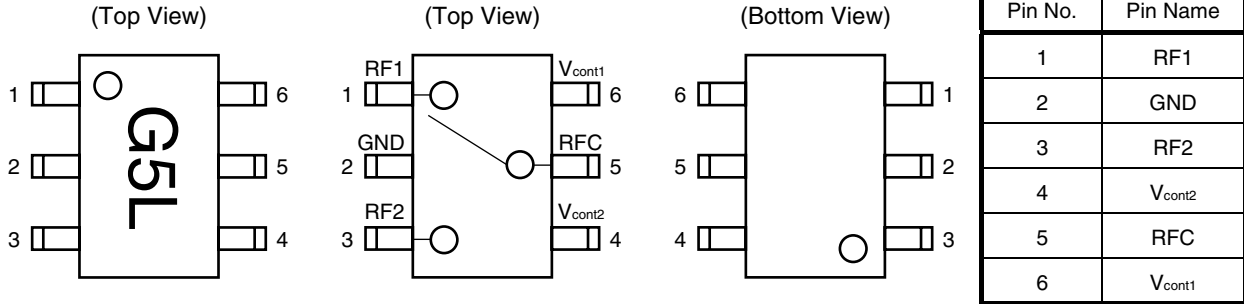

**SW TRUTH TABLE**

ON Path	V <sub>cont1</sub>	V <sub>cont2</sub>
RFC-RF1	High	Low
RFC-RF2	Low	High

**ABSOLUTE MAXIMUM RATINGS (T<sub>A</sub> = +25°C, unless otherwise specified)**

Parameter	Symbol	Ratings	Unit
Switch Control Voltage	V <sub>cont</sub>	+6.0 <sup>Note</sup>	V
Input Power	f = 0.01 to 0.5 GHz	P <sub>in1</sub>	+24.0
	f = 0.5 to 3.0 GHz	P <sub>in2</sub>	+31.0
Operating Ambient Temperature	T <sub>A</sub>	-45 to +85	°C
Storage Temperature	T <sub>stg</sub>	-55 to +150	°C

**Note** |V<sub>cont1</sub> - V<sub>cont2</sub>| ≤ 6.0 V

**RECOMMENDED OPERATING RANGE (T<sub>A</sub> = +25°C, unless otherwise specified)**

Parameter	Symbol	MIN.	TYP.	MAX.	Unit
Switch Control Voltage (H)	V <sub>cont (H)</sub>	1.8	2.7	5.3	V
Switch Control Voltage (L)	V <sub>cont (L)</sub>	-0.2	0	0.2	V

**ELECTRICAL CHARACTERISTICS**

(T<sub>A</sub> = +25°C, V<sub>cont</sub> (H) = 2.7 V, V<sub>cont</sub> (L) = 0 V, DC blocking capacitors = 56 pF, unless otherwise specified)

Parameter	Symbol	Test Conditions	MIN.	TYP.	MAX.	Unit
Insertion Loss 1	L <sub>ins1</sub>	f = 0.01 to 0.05 GHz <sup>Note 1</sup>	–	0.40	–	dB
Insertion Loss 2	L <sub>ins2</sub>	f = 0.05 to 0.5 GHz <sup>Note 2</sup>	–	0.40	0.45	dB
Insertion Loss 3	L <sub>ins3</sub>	f = 0.5 to 1.0 GHz	–	0.40	0.45	dB
Insertion Loss 4	L <sub>ins4</sub>	f = 1.0 to 2.0 GHz	–	0.45	0.50	dB
Insertion Loss 5	L <sub>ins5</sub>	f = 2.0 to 2.5 GHz	–	0.47	0.55	dB
Insertion Loss 6	L <sub>ins6</sub>	f = 2.5 to 3.0 GHz	–	0.53	0.60	dB
Isolation 1	ISL1	f = 0.01 to 0.05 GHz <sup>Note 1</sup>	–	27	–	dB
Isolation 2	ISL2	f = 0.05 to 0.5 GHz <sup>Note 2</sup>	23	27	–	dB
Isolation 3	ISL3	f = 0.5 to 1.0 GHz	23	27	–	dB
Isolation 4	ISL4	f = 1.0 to 2.0 GHz	16	19	–	dB
Isolation 5	ISL5	f = 2.0 to 2.5 GHz	14	17	–	dB
Isolation 6	ISL6	f = 2.5 to 3.0 GHz	14	17	–	dB
Input Return Loss 1	RL <sub>in1</sub>	f = 0.01 to 0.05 GHz <sup>Note 1</sup>	–	20	–	dB
Input Return Loss 2	RL <sub>in2</sub>	f = 0.05 to 0.5 GHz <sup>Note 2</sup>	15	20	–	dB
Input Return Loss 3	RL <sub>in3</sub>	f = 0.5 to 3.0 GHz	15	20	–	dB
Output Return Loss 1	RL <sub>out1</sub>	f = 0.01 to 0.05 GHz <sup>Note 1</sup>	–	20	–	dB
Output Return Loss 2	RL <sub>out2</sub>	f = 0.05 to 0.5 GHz <sup>Note 2</sup>	15	20	–	dB
Output Return Loss 3	RL <sub>out3</sub>	f = 0.5 to 3.0 GHz	15	20	–	dB
0.1 dB Loss Compression Input Power <sup>Note 3</sup>	P <sub>in (0.1 dB)</sub>	f = 2.0/2.5 GHz	+26.0	+29.0	–	dBm
		f = 0.5 to 3.0 GHz	–	+29.0	–	dBm
1 dB Loss Compression Input Power <sup>Note 4</sup>	P <sub>in (1 dB)</sub>	f = 0.5 to 3.0 GHz	–	+30.5	–	dBm
2nd Harmonics	2f <sub>0</sub>	f = 2.0/2.5 GHz, P <sub>in</sub> = +20 dBm	65	75	–	dBc
3rd Harmonics	3f <sub>0</sub>	f = 2.0/2.5 GHz, P <sub>in</sub> = +20 dBm	65	75	–	dBc
Intermodulation Intercept Point	IIP <sub>3</sub>	f = 0.5 to 3.0 GHz, 2 tone, 5 MHz spicing	–	+60	–	dBm
Switch Control Current	I <sub>cont</sub>	No RF input	–	0.2	20	μA
Switch Control Speed	t <sub>sw</sub>	50% CTL to 90/10% RF	–	50	500	ns

**Notes 1.** DC blocking capacitors = 10 000 pF at f = 0.01 to 0.05 GHz

**2.** DC blocking capacitors = 1 000 pF at f = 0.05 to 0.5 GHz

**3.** P<sub>in (0.1 dB)</sub> is measured the input power level when the insertion loss increases more 0.1 dB than that of linear range.

**4.** P<sub>in (1 dB)</sub> is measured the input power level when the insertion loss increases more 1 dB than that of linear range.

**Caution** This device is used it is necessary to use DC blocking capacitors.

The value of DC blocking capacitors should be chosen to accommodate the frequency of operation, bandwidth, switching speed and the condition with actual board of your system. The range of recommended DC blocking capacitor value is less than 56 pF.

**ELECTRICAL CHARACTERISTICS**

(T<sub>A</sub> = +25°C, V<sub>cont</sub> (H) = 1.8 V, V<sub>cont</sub> (L) = 0 V, DC blocking capacitors = 56 pF, unless otherwise specified)

Parameter	Symbol	Test Conditions	MIN.	TYP.	MAX.	Unit
Insertion Loss 7	L <sub>ins7</sub>	f = 0.01 to 0.05 GHz <sup>Note 1</sup>	–	0.40	–	dB
Insertion Loss 8	L <sub>ins8</sub>	f = 0.05 to 0.5 GHz <sup>Note 2</sup>	–	0.40	0.46	dB
Insertion Loss 9	L <sub>ins9</sub>	f = 0.5 to 1.0 GHz	–	0.40	0.47	dB
Insertion Loss 10	L <sub>ins10</sub>	f = 1.0 to 2.0 GHz	–	0.46	0.52	dB
Insertion Loss 11	L <sub>ins11</sub>	f = 2.0 to 2.5 GHz	–	0.48	0.57	dB
Insertion Loss 12	L <sub>ins12</sub>	f = 2.5 to 3.0 GHz	–	0.54	0.62	dB
Isolation 7	ISL7	f = 0.01 to 0.05 GHz <sup>Note 1</sup>	–	27	–	dB
Isolation 8	ISL8	f = 0.05 to 0.5 GHz <sup>Note 2</sup>	23	27	–	dB
Isolation 9	ISL9	f = 0.5 to 1.0 GHz	23	27	–	dB
Isolation 10	ISL10	f = 1.0 to 2.0 GHz	16	19	–	dB
Isolation 11	ISL11	f = 2.0 to 2.5 GHz	14	17	–	dB
Isolation 12	ISL12	f = 2.5 to 3.0 GHz	14	17	–	dB
Input Return Loss 4	RL <sub>in4</sub>	f = 0.01 to 0.05 GHz <sup>Note 1</sup>	–	20	–	dB
Input Return Loss 5	RL <sub>in5</sub>	f = 0.05 to 0.5 GHz <sup>Note 2</sup>	15	20	–	dB
Input Return Loss 6	RL <sub>in6</sub>	f = 0.5 to 3.0 GHz	15	20	–	dB
Output Return Loss 4	RL <sub>out4</sub>	f = 0.01 to 0.05 GHz <sup>Note 1</sup>	–	20	–	dB
Output Return Loss 5	RL <sub>out5</sub>	f = 0.05 to 0.5 GHz <sup>Note 2</sup>	15	20	–	dB
Output Return Loss 6	RL <sub>out6</sub>	f = 0.5 to 3.0 GHz	15	20	–	dB
0.1 dB Loss Compression Input Power <sup>Note 3</sup>	P <sub>in (0.1 dB)</sub>	f = 2.0/2.5 GHz	+19.0	+22.0	–	dBm
		f = 0.5 to 3.0 GHz	–	+22.0	–	dBm
1 dB Loss Compression Input Power <sup>Note 4</sup>	P <sub>in (1 dB)</sub>	f = 0.5 to 3.0 GHz	–	+25.0	–	dBm
Switch Control Current	I <sub>cont</sub>	No RF input	–	0.2	20	μA
Switch Control Speed	t <sub>sw</sub>	50% CTL to 90/10% RF	–	50	500	ns

- Notes**
- DC blocking capacitors = 10 000 pF at f = 0.01 to 0.05 GHz
  - DC blocking capacitors = 1 000 pF at f = 0.05 to 0.5 GHz
  - P<sub>in (0.1 dB)</sub> is measured the input power level when the insertion loss increases more 0.1 dB than that of linear range.
  - P<sub>in (1 dB)</sub> is measured the input power level when the insertion loss increases more 1 dB than that of linear range.

**Caution** This device is used it is necessary to use DC blocking capacitors.  
 The value of DC blocking capacitors should be chosen to accommodate the frequency of operation, bandwidth, switching speed and the condition with actual board of your system. The range of recommended DC blocking capacitor value is less than 56 pF.

EVALUATION CIRCUIT

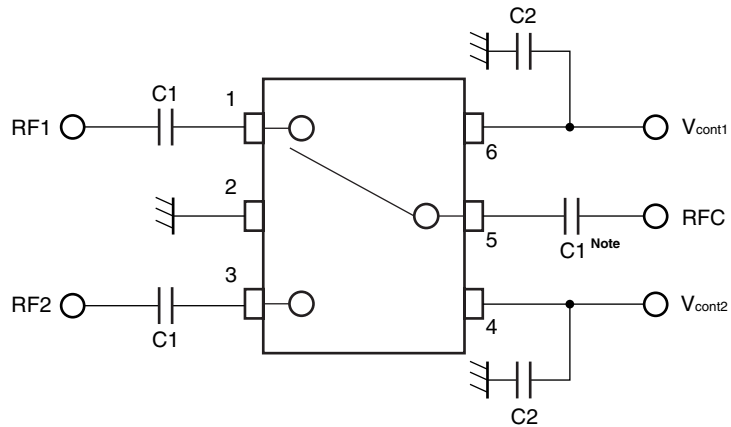

**Note** C1 : 0.01 to 0.05 GHz 10 000 pF  
 : 0.05 to 0.5 GHz 1 000 pF  
 : 0.5 to 3.0 GHz 56 pF  
 C2 : 1 000 pF

The application circuits and their parameters are for reference only and are not intended for use in actual design-ins.

APPLICATION INFORMATION

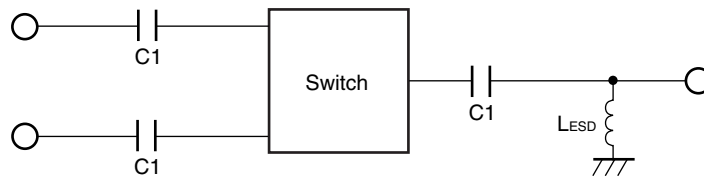

- L<sub>ESD</sub> provides a means to increase the ESD protection on a specific RF port, typically the port attached to the antenna.
- The value may be tailored to provide specific electrical responses.
- The RF ground connections should be kept as short as possible and connected to directly to a good RF ground for best performance.

ILLUSTRATION OF THE TEST CIRCUIT ASSEMBLED ON EVALUATION BOARD

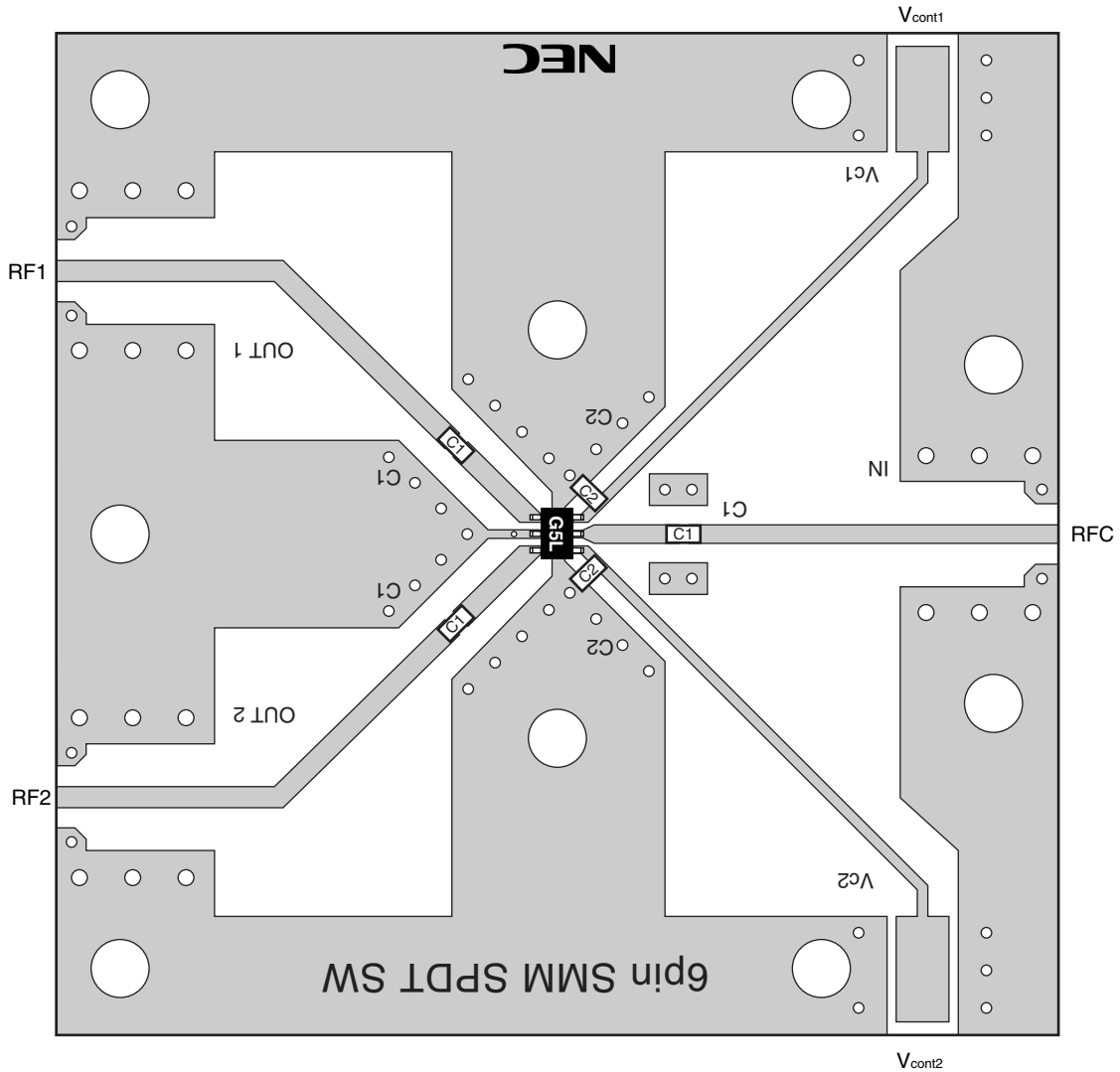

USING THE NEC EVALUATION BOARD

Symbol	Test Conditions	Values
C1	f = 0.01 to 0.05 GHz	10 000 pF
	f = 0.05 to 0.5 GHz	1 000 pF
	f = 0.5 to 3.0 GHz	56 pF
C2		1 000 pF

**TYPICAL CHARACTERISTICS (TA = +25°C, DC blocking capacitors = 56 pF, unless otherwise specified)**

RFC-RF1/RF2  
INSERTION LOSS vs. FREQUENCY

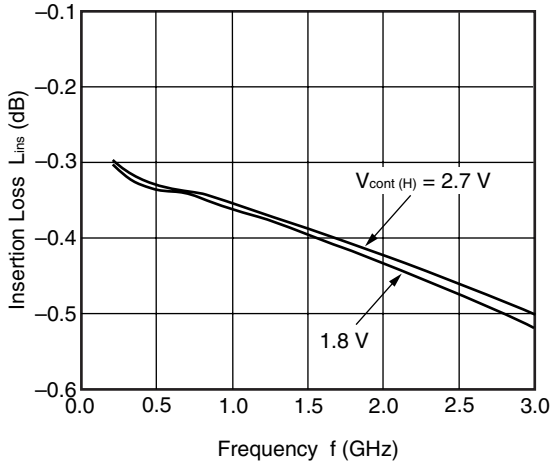

RFC-RF1/RF2  
ISOLATION vs. FREQUENCY

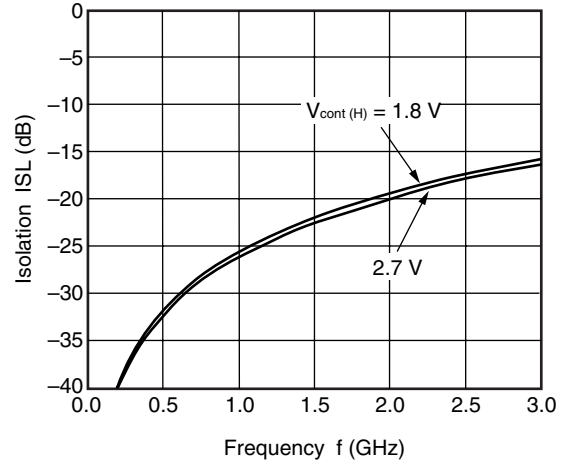

RFC-RF1/RF2  
INPUT RETURN LOSS vs. FREQUENCY

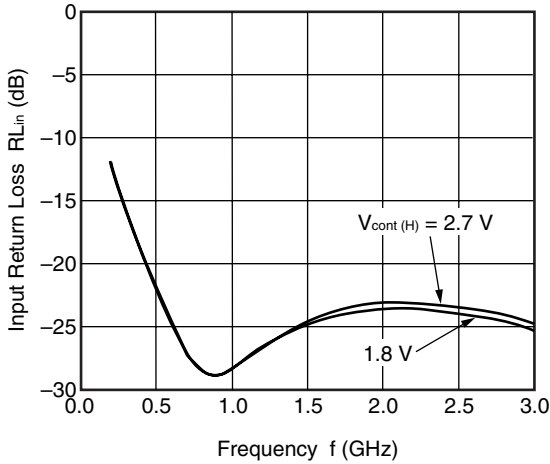

RFC-RF1/RF2  
OUTPUT RETURN LOSS vs. FREQUENCY

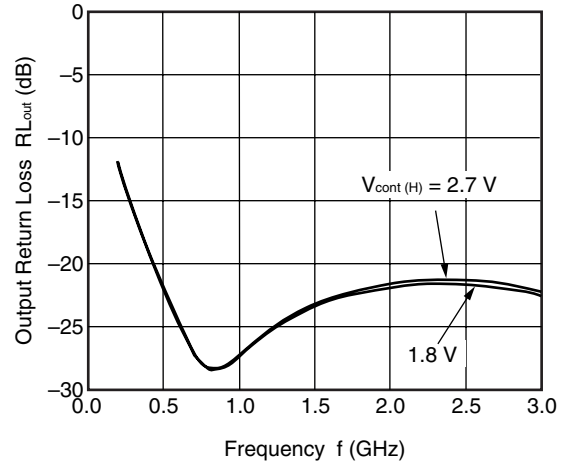

RFC-RF1/RF2 INSERTION LOSS,  
Icont vs. SWITCH CONTROL VOLTAGE (H)

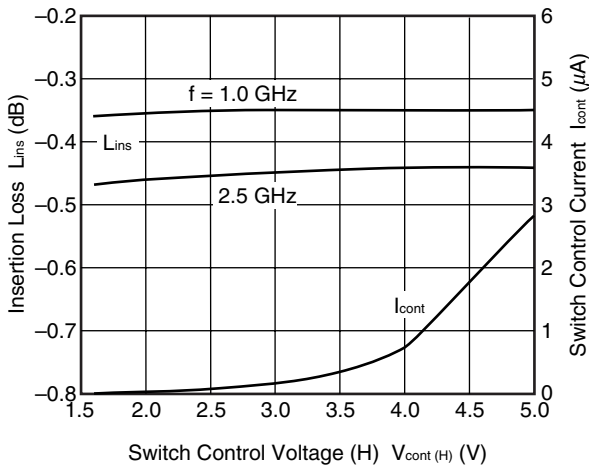

RFC-RF1/RF2 ISOLATION vs.  
SWITCH CONTROL VOLTAGE (H)

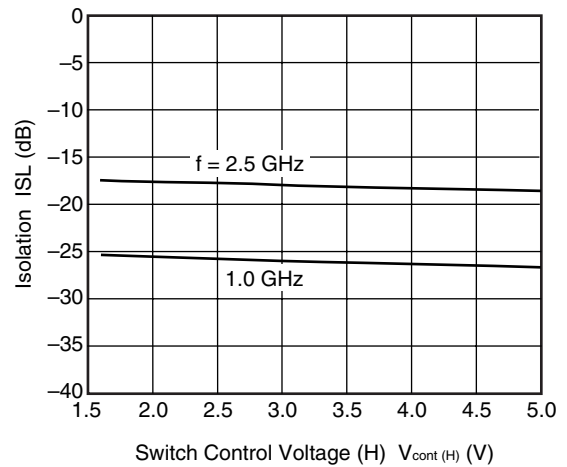

**Remark** The graphs indicate nominal characteristics.

RFC-RF1/RF2 INPUT RETURN LOSS vs. SWITCH CONTROL VOLTAGE (H)

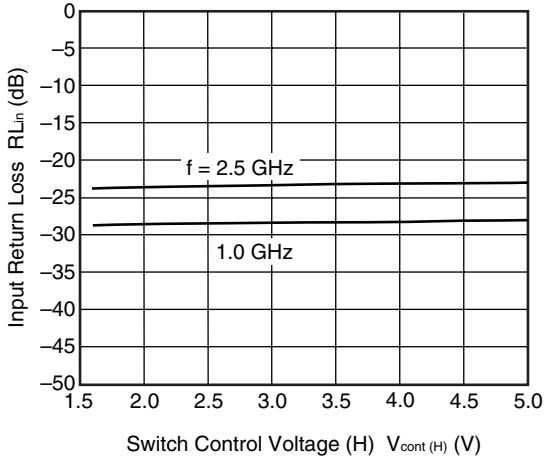

RFC-RF1/RF2 OUTPUT RETURN LOSS vs. SWITCH CONTROL VOLTAGE (H)

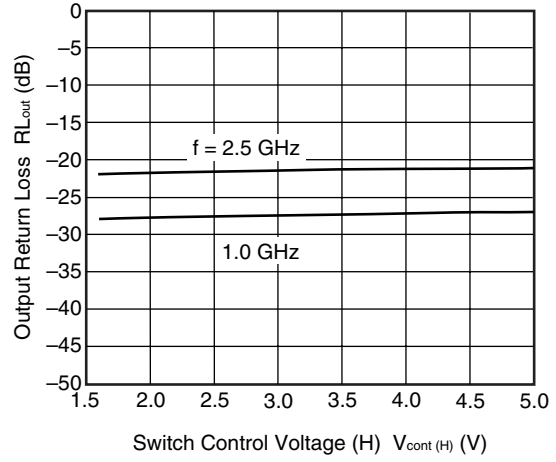

RFC-RF1/RF2 INSERTION LOSS, I\_cont vs. INPUT POWER

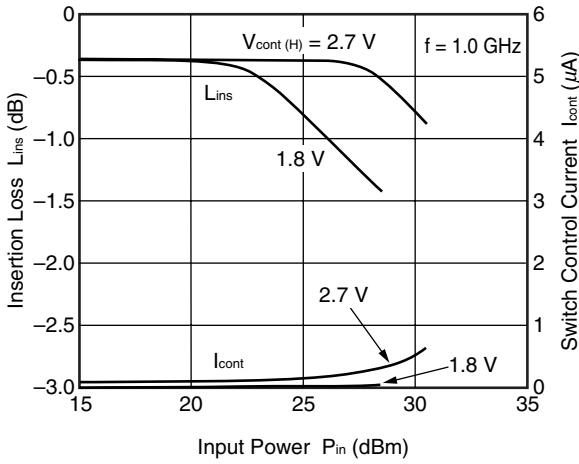

RFC-RF1/RF2 INSERTION LOSS, I\_cont vs. INPUT POWER

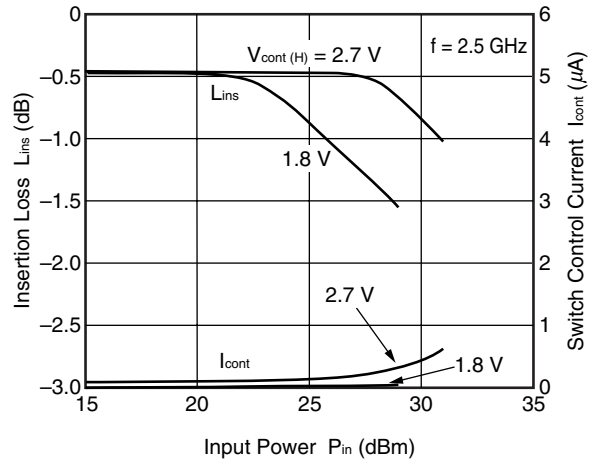

RFC-RF1/RF2 INPUT POWER vs. SWITCH CONTROL VOLTAGE (H)

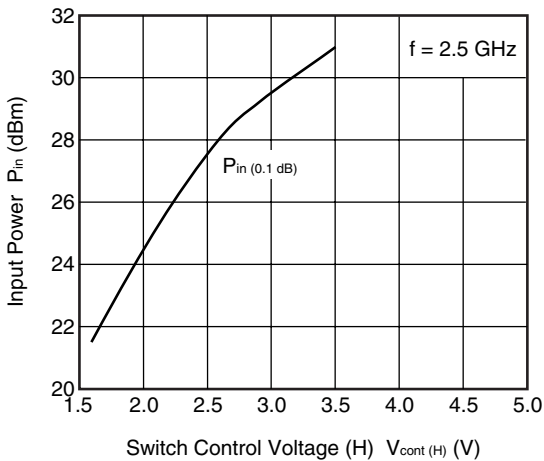

RFC-RF1/RF2 INPUT POWER vs. FREQUENCY

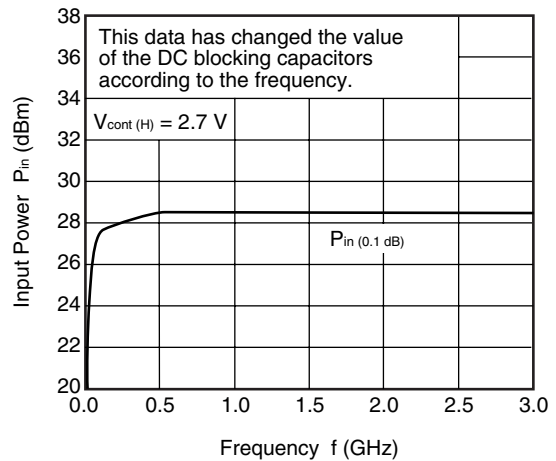

**Remark** The graphs indicate nominal characteristics.



**MOUNTING PAD LAYOUT DIMENSIONS**

**6-PIN SUPER MINIMOLD (UNIT: mm)**

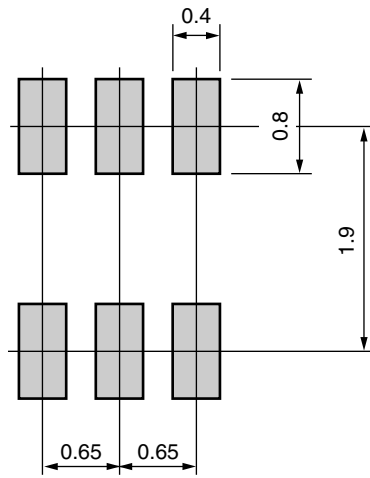

**Remark** The mounting pad layout in this document is for reference only.

PACKAGE DIMENSIONS

6-PIN SUPER MINIMOLD (UNIT: mm)

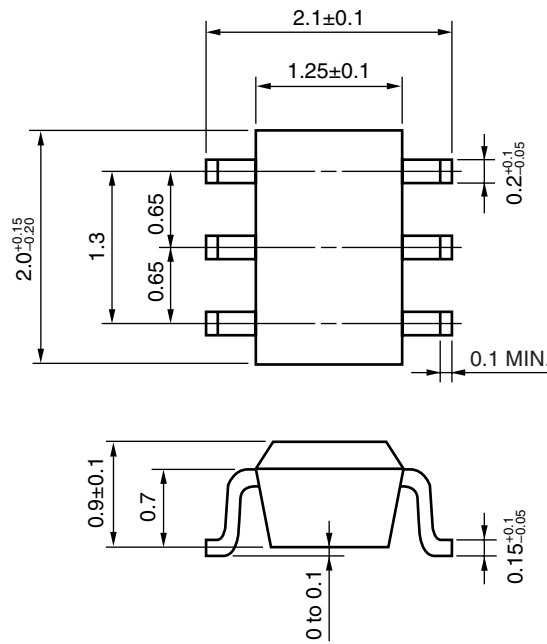

**RECOMMENDED SOLDERING CONDITIONS**

This product should be soldered and mounted under the following recommended conditions. For soldering methods and conditions other than those recommended below, contact your nearby sales office.

Soldering Method	Soldering Conditions	Condition Symbol
Infrared Reflow	Peak temperature (package surface temperature) : 260°C or below Time at peak temperature : 10 seconds or less Time at temperature of 220°C or higher : 60 seconds or less Preheating time at 120 to 180°C : 120±30 seconds Maximum number of reflow processes : 3 times Maximum chlorine content of rosin flux (% mass) : 0.2%(Wt.) or below	IR260
Wave Soldering	Peak temperature (molten solder temperature) : 260°C or below Time at peak temperature : 10 seconds or less Preheating temperature (package surface temperature) : 120°C or below Maximum number of flow processes : 1 time Maximum chlorine content of rosin flux (% mass) : 0.2%(Wt.) or below	WS260
Partial Heating	Peak temperature (terminal temperature) : 350°C or below Soldering time (per side of device) : 3 seconds or less Maximum chlorine content of rosin flux (% mass) : 0.2%(Wt.) or below	HS350

**Caution Do not use different soldering methods together (except for partial heating).**

**Bluetooth is a trademark owned by Bluetooth SIG, Inc., U.S.A.**

• **The information in this document is current as of January, 2009. The information is subject to change without notice. For actual design-in, refer to the latest publications of NEC Electronics data sheets or data books, etc., for the most up-to-date specifications of NEC Electronics products. Not all products and/or types are available in every country. Please check with an NEC Electronics sales representative for availability and additional information.**

- No part of this document may be copied or reproduced in any form or by any means without the prior written consent of NEC Electronics. NEC Electronics assumes no responsibility for any errors that may appear in this document.
- NEC Electronics does not assume any liability for infringement of patents, copyrights or other intellectual property rights of third parties by or arising from the use of NEC Electronics products listed in this document or any other liability arising from the use of such products. No license, express, implied or otherwise, is granted under any patents, copyrights or other intellectual property rights of NEC Electronics or others.
- Descriptions of circuits, software and other related information in this document are provided for illustrative purposes in semiconductor product operation and application examples. The incorporation of these circuits, software and information in the design of a customer's equipment shall be done under the full responsibility of the customer. NEC Electronics assumes no responsibility for any losses incurred by customers or third parties arising from the use of these circuits, software and information.
- While NEC Electronics endeavors to enhance the quality, reliability and safety of NEC Electronics products, customers agree and acknowledge that the possibility of defects thereof cannot be eliminated entirely. To minimize risks of damage to property or injury (including death) to persons arising from defects in NEC Electronics products, customers must incorporate sufficient safety measures in their design, such as redundancy, fire-containment and anti-failure features.
- NEC Electronics products are classified into the following three quality grades: "Standard", "Special" and "Specific".

The "Specific" quality grade applies only to NEC Electronics products developed based on a customer-designated "quality assurance program" for a specific application. The recommended applications of an NEC Electronics product depend on its quality grade, as indicated below. Customers must check the quality grade of each NEC Electronics product before using it in a particular application.

"Standard": Computers, office equipment, communications equipment, test and measurement equipment, audio and visual equipment, home electronic appliances, machine tools, personal electronic equipment and industrial robots.

"Special": Transportation equipment (automobiles, trains, ships, etc.), traffic control systems, anti-disaster systems, anti-crime systems, safety equipment and medical equipment (not specifically designed for life support).

"Specific": Aircraft, aerospace equipment, submersible repeaters, nuclear reactor control systems, life support systems and medical equipment for life support, etc.

The quality grade of NEC Electronics products is "Standard" unless otherwise expressly specified in NEC Electronics data sheets or data books, etc. If customers wish to use NEC Electronics products in applications not intended by NEC Electronics, they must contact an NEC Electronics sales representative in advance to determine NEC Electronics' willingness to support a given application.

(Note)

- (1) "NEC Electronics" as used in this statement means NEC Electronics Corporation and also includes its majority-owned subsidiaries.
- (2) "NEC Electronics products" means any product developed or manufactured by or for NEC Electronics (as defined above).

<p><b>Caution</b> GaAs Products</p>	<p>This product uses gallium arsenide (GaAs). GaAs vapor and powder are hazardous to human health if inhaled or ingested, so please observe the following points.</p> <ul style="list-style-type: none"> <li>• Follow related laws and ordinances when disposing of the product. If there are no applicable laws and/or ordinances, dispose of the product as recommended below.             <ol style="list-style-type: none"> <li>1. Commission a disposal company able to (with a license to) collect, transport and dispose of materials that contain arsenic and other such industrial waste materials.</li> <li>2. Exclude the product from general industrial waste and household garbage, and ensure that the product is controlled (as industrial waste subject to special control) up until final disposal.</li> </ol> </li> <li>• Do not burn, destroy, cut, crush, or chemically dissolve the product.</li> <li>• Do not lick the product or in any way allow it to enter the mouth.</li> </ul>
-------------------------------------	---