

**Pb-free
HEAT**

STANLEY

U□1106W Series

Single Color Super Wide Angle Type (h=1.3 mm)

Features

Package	Super Wide Angle Type (h=1.3 mm), Water Clear resin
Product features	<ul style="list-style-type: none"> ▪ Outer Dimension 2.5 x 2.0 x 1.3mm (L x W x H) ▪ Temperature range Storage Temperature : -40°C ~ 120°C Operating Temperature : -40°C ~ 100°C ▪ Lead-free soldering compatible ▪ RoHS compliant
Dominant wavelength	<p>Blue : 470nm(UB)</p> <p>Green : 525nm(UG)</p> <p>Red : 630nm(UR)</p>
Half Intensity Angle	<p>UB, UG : 128 deg.</p> <p>UR : 140 deg.</p>
Die materials	UB, UG : InGaN, UR : AlGaInP
Rank grouping parameter	Sorted by luminous intensity and wavelength per rank taping
Assembly method	Auto pick & place machine (Auto Mounter)
Soldering methods	Reflow soldering and manual soldering
Taping and reel	2,500pcs per reel in a 8mm width tape. (Standard) Reel diameter: ϕ 180mm
ESD	InGaN : 1kV(HBM), AlGaInP : More than 2kV(HBM)

Recommended Applications

Amusement Equipment, Electric Household Appliances, OA/FA, Other General Applications



U□1106W Series

Single Color Super Wide Angle Type (h=1.3 mm)

Color and Luminous Intensity

(Ta=25°C)

Part No.	Material	Emitted Color	Lens Color	Dominant Wavelength λ_d (nm)		Luminous Intensity I_v (mcd)		
				TYP.	I_F	MIN.	TYP.	I_F
				UB1106W	InGaN	Blue	Water Clear	470
UG1106W	InGaN	Green	525	10	33	100		10
UR1106W	AlGaInP	Red	630	20	47	100		20

Absolute Maximum Ratings

(Ta=25°C)

Item	Symbol	Absolute Maximum Ratings			Unit
		UB	UG	UR	
Power Dissipation	P_d	84	84	87	mW
Forward Current	I_F	20	20	30	mA
Pulse Forward Current ※1	I_{FRM}	100	100	100	mA
Derating (Ta=60°C or higher)	ΔI_F	0.45	0.45	1.00※2	mA/°C
	ΔI_{FRM}	2.22	2.22	3.33※2	mA/°C
Reverse Voltage	V_R	5	5	5	V
Operating Temperature	T_{opr}	-40~+100			°C
Storage Temperature	T_{stg}	-40~+120			°C

※1 I_{FRM} Measurement condition : Pulse Width ≤ 1 ms., Duty $\leq 1/20$.

※2 Temperature Condition : Ta=85°C or higher.

Electro-Optical Characteristics(UB,UG)

(Ta=25°C)

Item	Conditions	Symbol	Characteristics		Unit	
			UB	UG		
Forward Voltage	I _F =10mA	V _F	TYP.	3.3	V	
			MAX.	3.8		
Reverse Current	V _R =5V	I _R	MAX.	100	μ A	
Peak Wavelength	I _F =10mA	λ _p	TYP.	465	522	nm
Dominant Wavelength	I _F =10mA	λ _d	TYP.	470	525	nm
Spectral Line Half Width	I _F =10mA	Δλ	TYP.	26	35	nm
Half Intensity Angle	I _F =10mA	2θ 1/2	TYP.	128	128	deg.

Electro-Optical Characteristics(UR)

(Ta=25°C)

Item	Conditions	Symbol	Characteristics		Unit
			UR		
Forward Voltage	I _F =20mA	V _F	TYP.	2.2	V
			MAX.	2.8	
Reverse Current	V _R =5V	I _R	MAX.	100	μ A
Peak Wavelength	I _F =20mA	λ _p	TYP.	636	nm
Dominant Wavelength	I _F =20mA	λ _d	TYP.	630	nm
Spectral Line Half Width	I _F =20mA	Δλ	TYP.	15	nm
Half Intensity Angle	I _F =20mA	2θ 1/2	TYP.	140	deg.

Luminous Intensity Rank

(Ta=25°C)

Intensity Tolerance each Rank : +/- 10%

Rank	I _v (mcd)							
	UB		UG		UR			
	I _F =10mA		I _F =10mA		I _F =20mA			
	MIN.	MAX.	MIN.	MAX.	MIN.	MAX.		
BA	10	15	/		/			
BB	15	22						
BC	22	33						
BD	33	47	33	47	/			
BE	47	68	47	68			47	68
BF	/		68	100			68	100
CA			100	150	100	150		
CB			150	220	150	220		
CC			220	330	220	330		
CD			330	470	330	470		

Please contact our sales staff concerning rank designation.

Color Tone Groups (λd)

(Ta=25°C)

Tolerance: +/- 1 nm

Rank	Dominant Wavelength λd (nm)			
	UG		UR	
	I _F =10mA		I _F =20mA	
	MIN.	MAX.	MIN.	MAX.
A	515	520	620	626
B	520	525	626	632
C	525	530	632	638
D	530	535		

Please contact our sales staff concerning rank designation.

Technical Data(UB,UG)

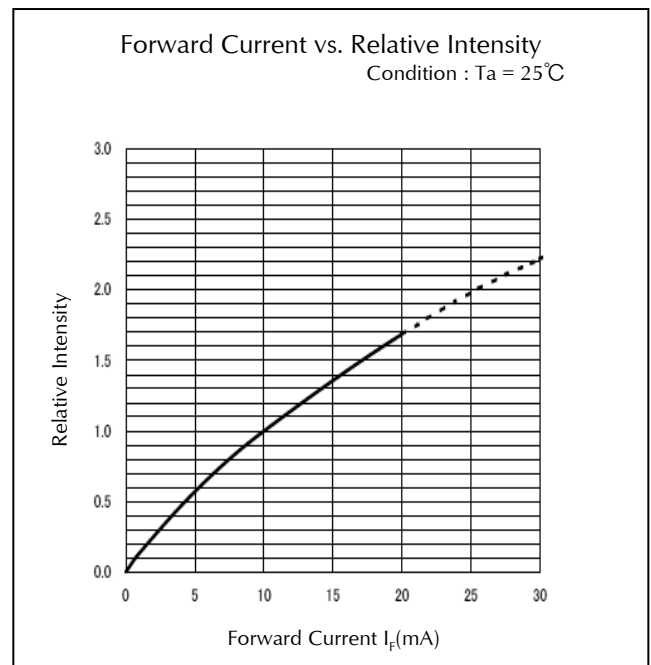
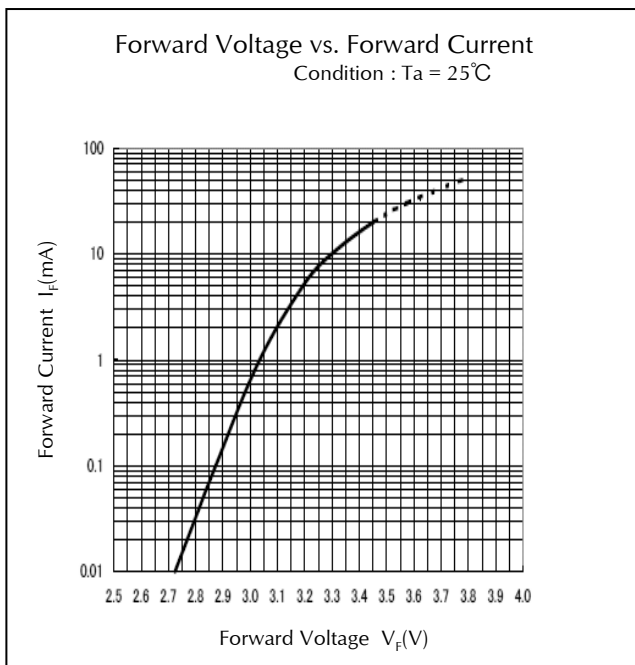
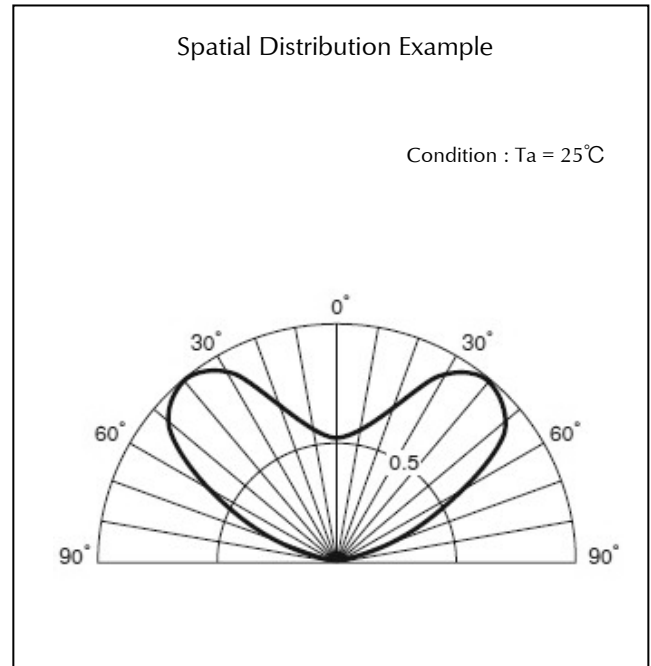
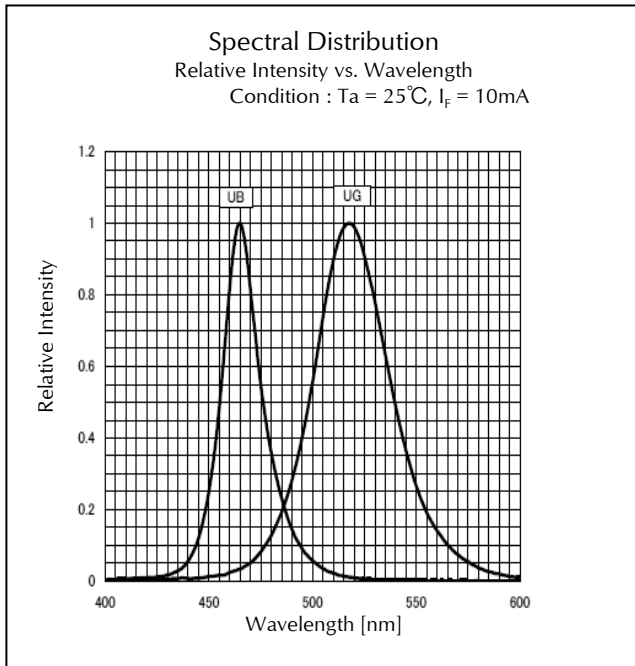

Technical Data(UB,UG)

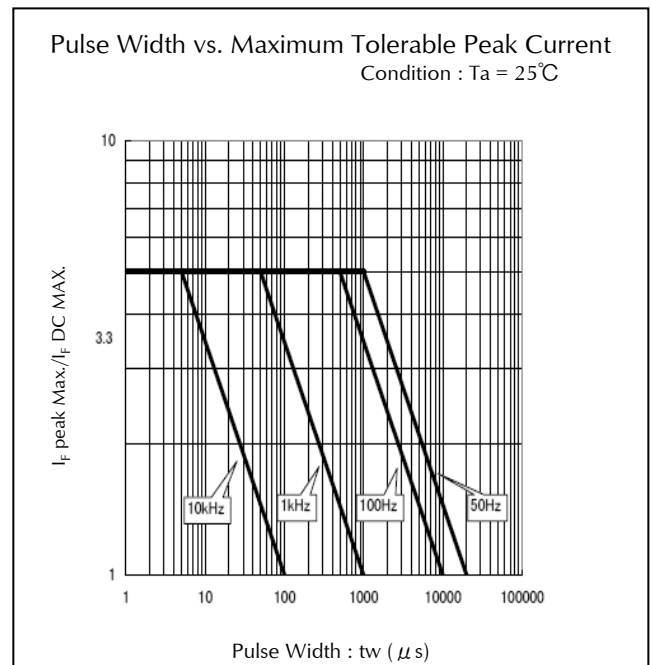
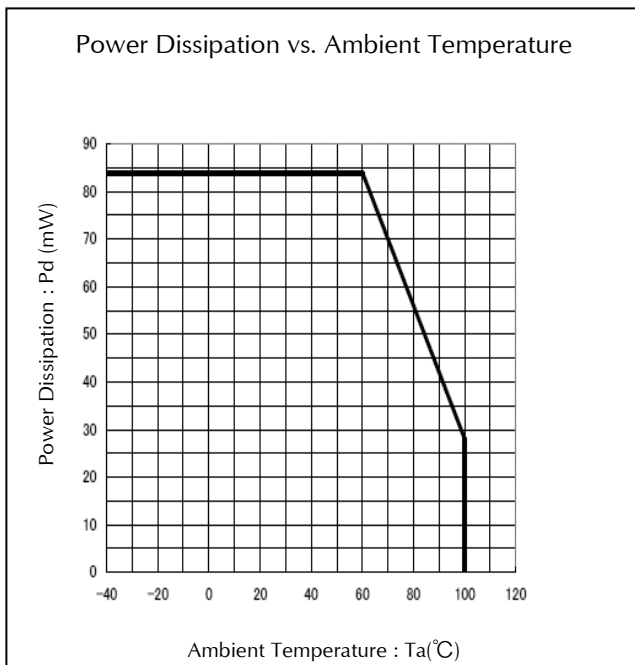
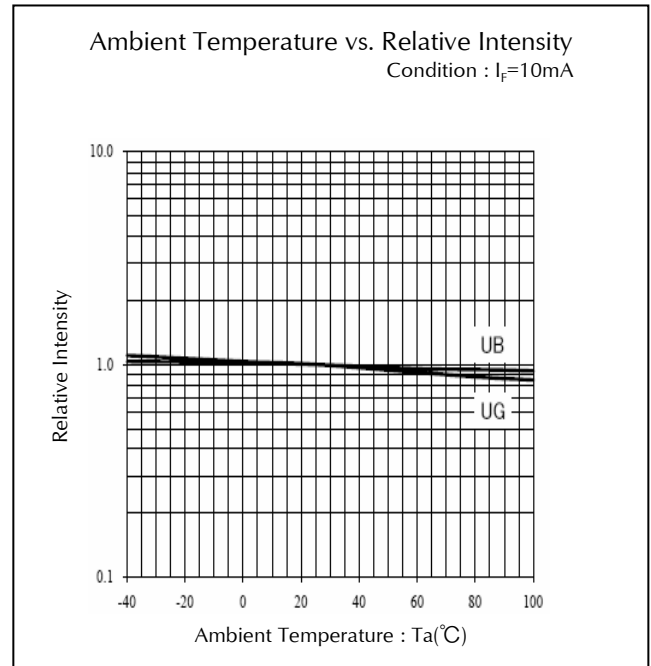
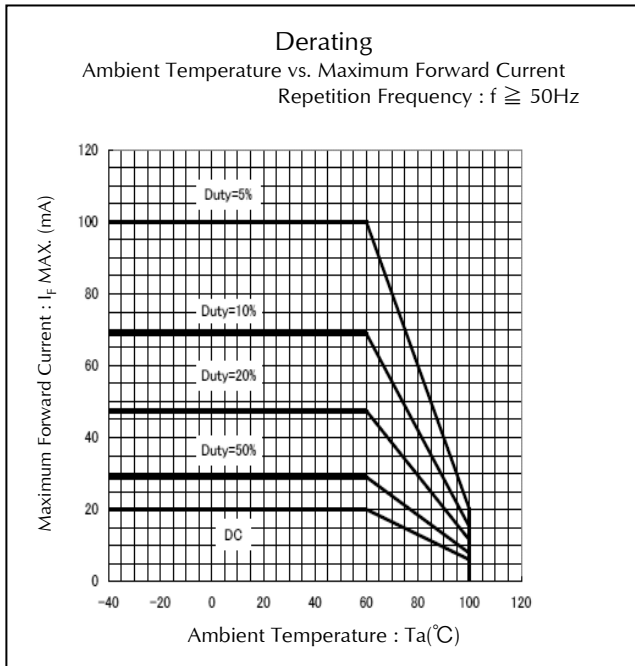

Technical Data(UB,UG)

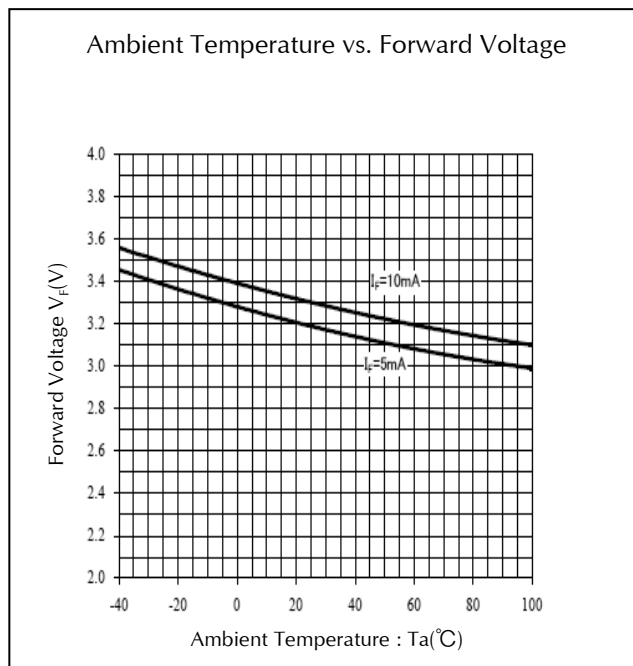
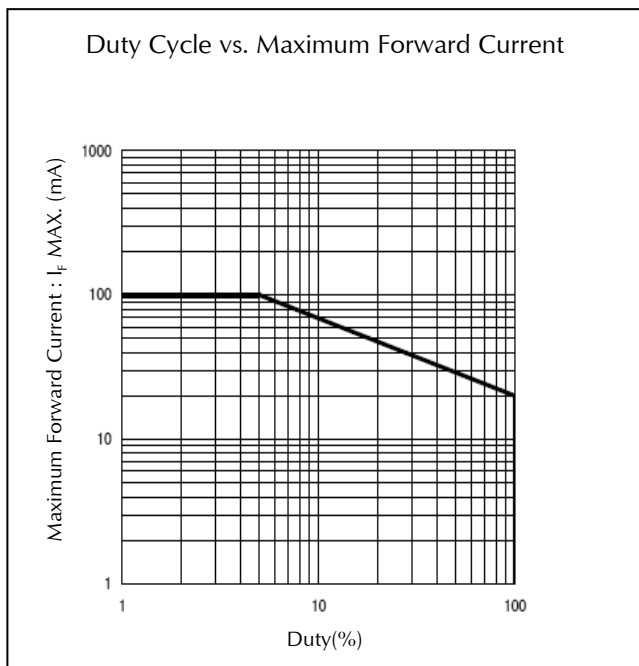

Technical Data(UR)

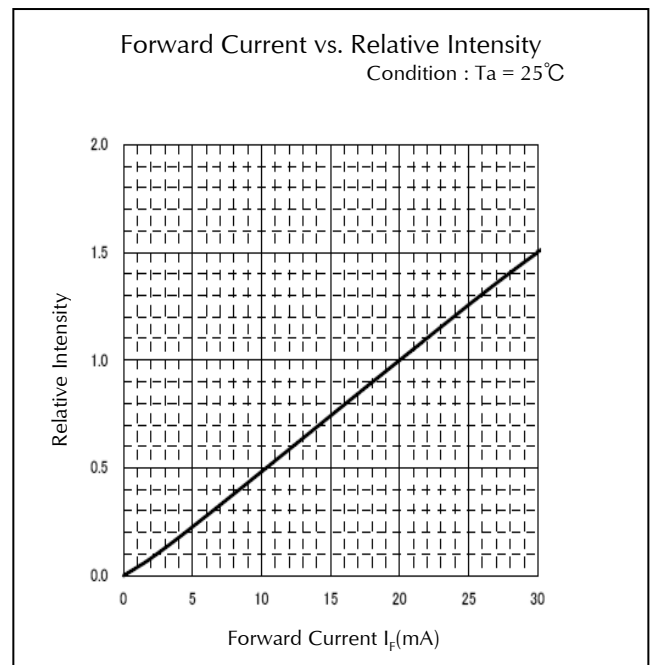
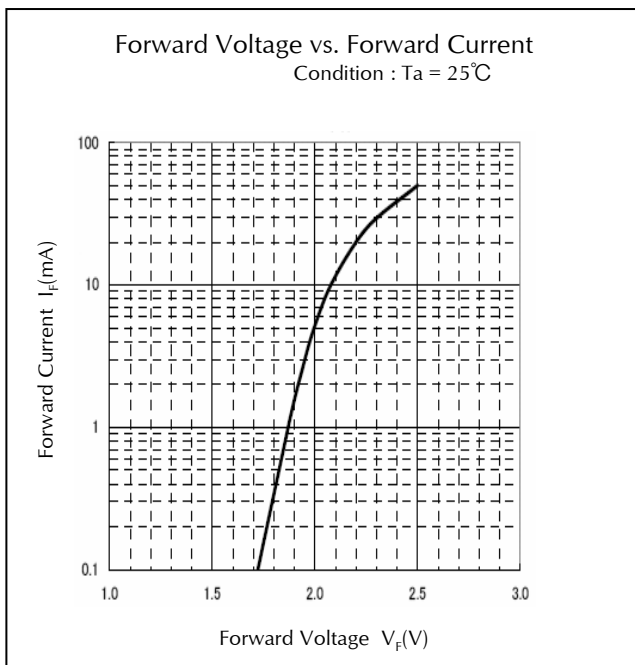
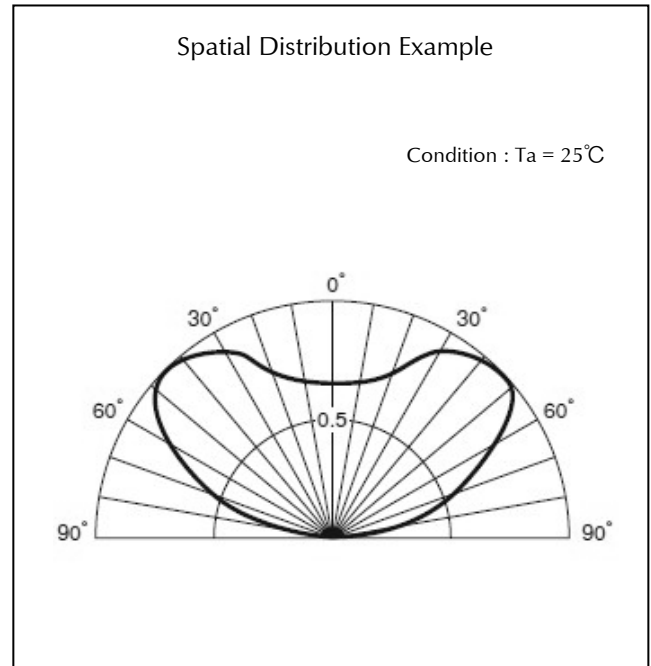
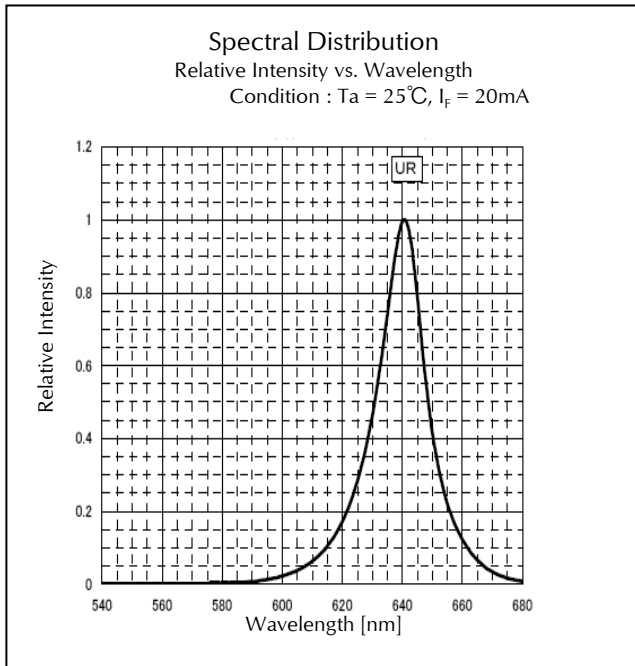

Technical Data(UR)

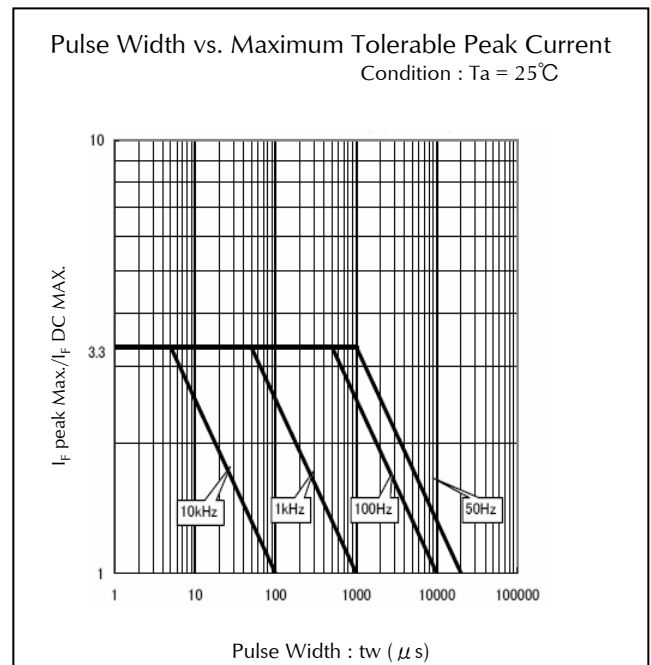
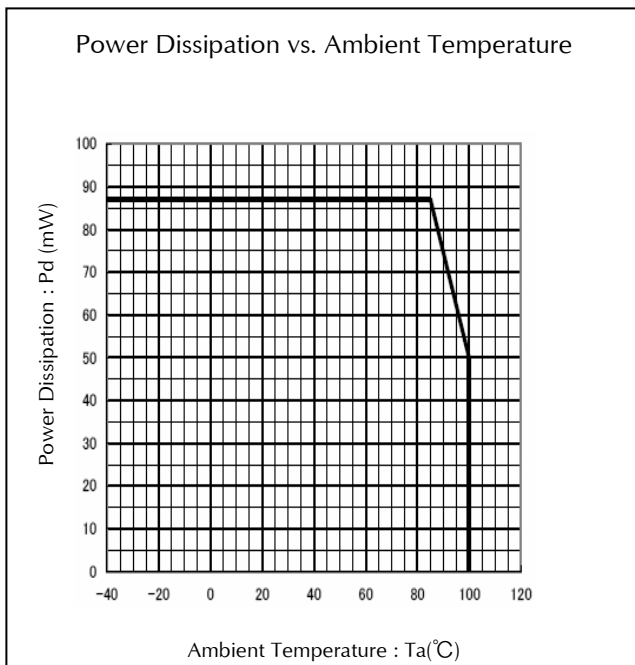
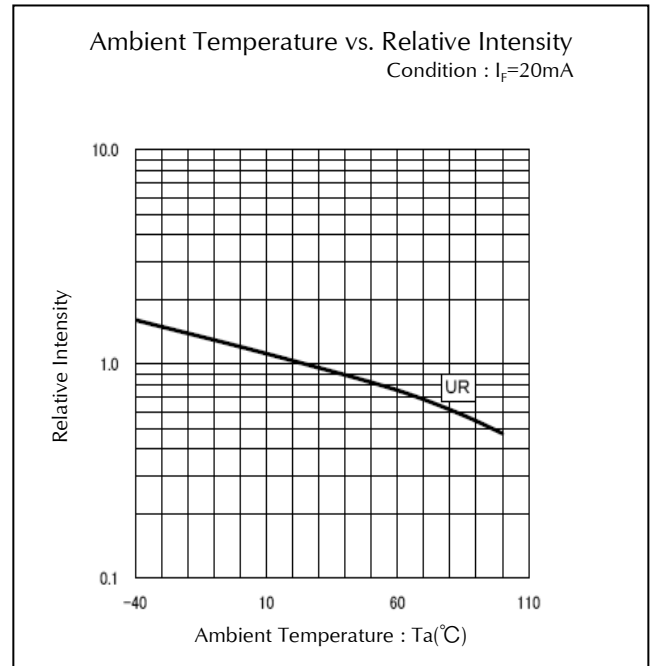
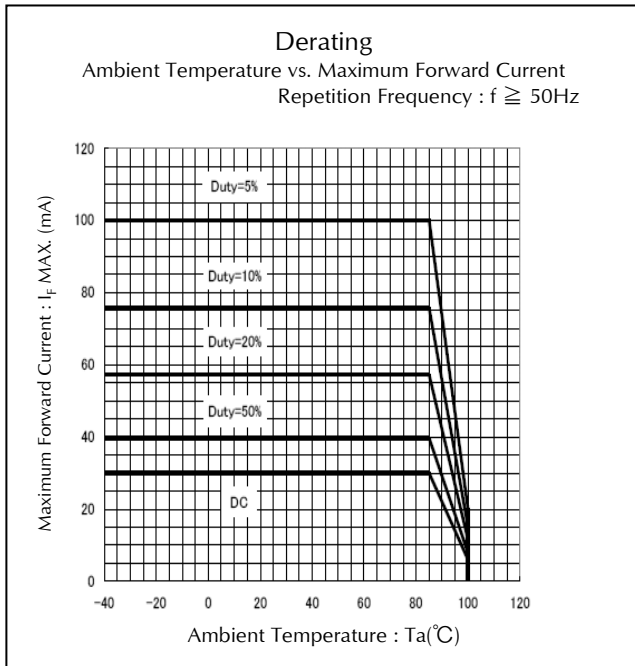

Technical Data(UR)

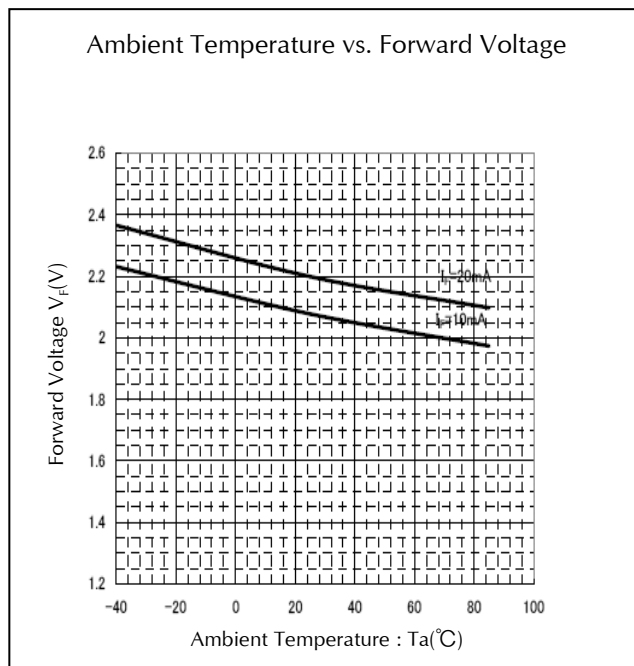
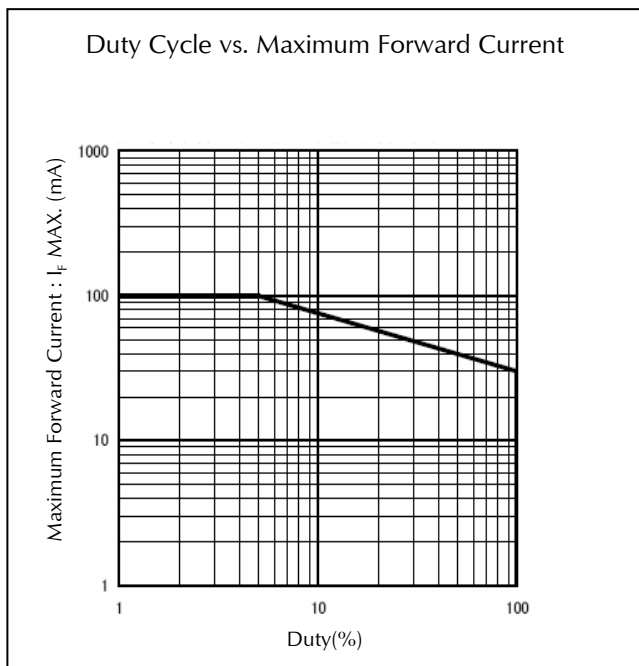

Package Dimensions

(Unit: mm)

Weight: (8.0)mg

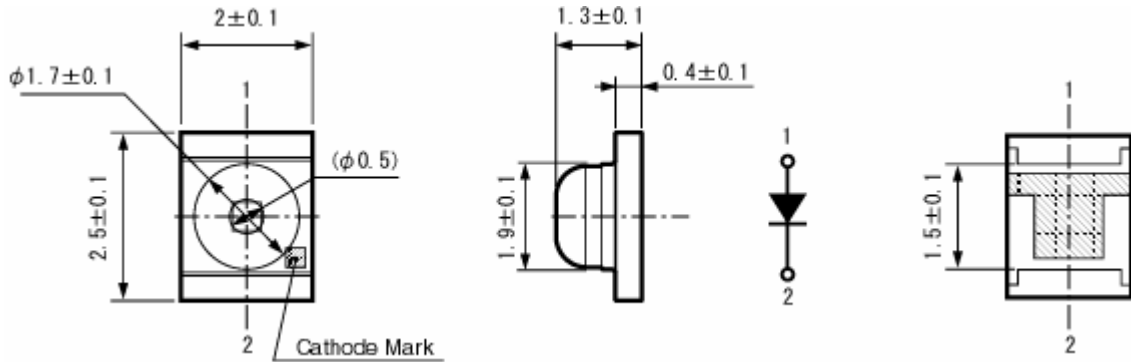

Recommended Soldering Pattern

(Unit: mm)

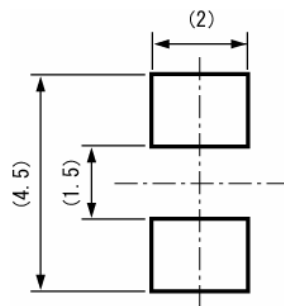

Taping Specification

(Unit: mm)

Quantity : 2,500pcs/ reel (standard)

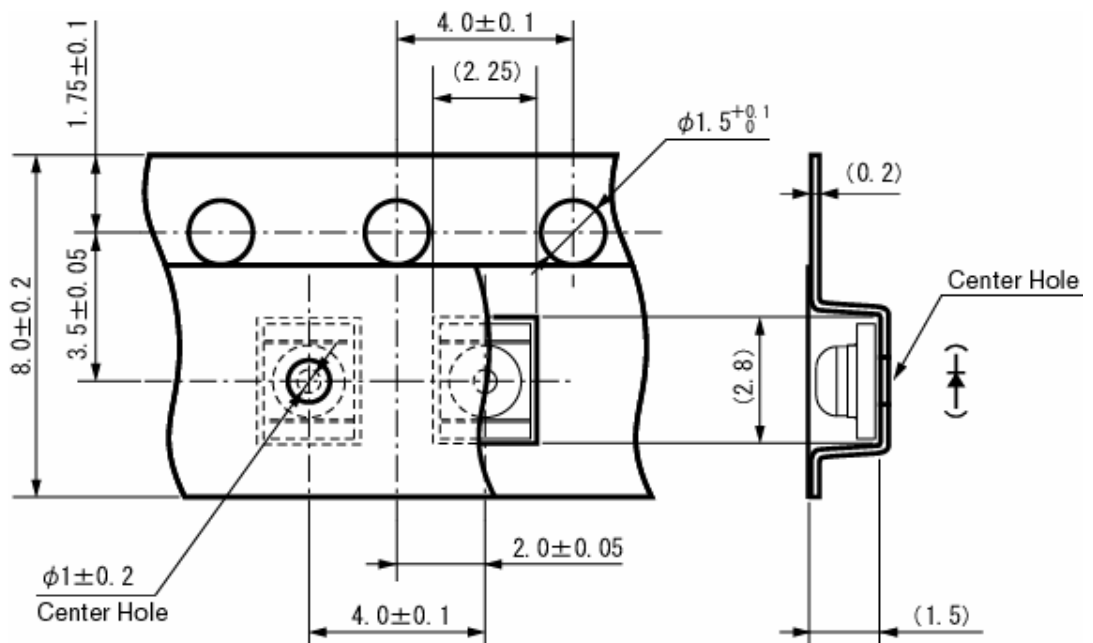

Reflow Soldering Conditions

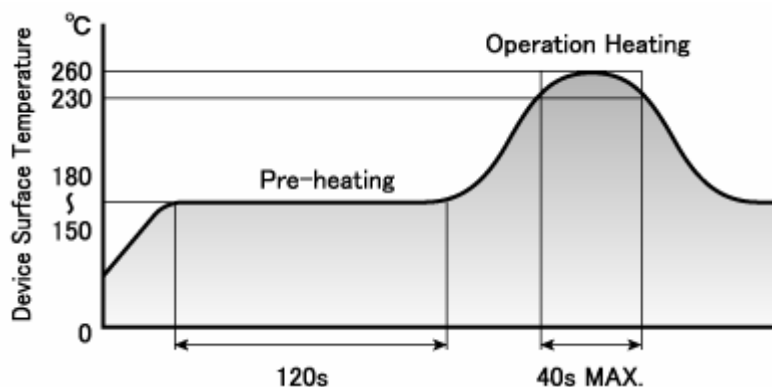

- 1) The above profile temperature gives the maximum temperature of the LED resin surface. Please set the temperature so as to avoid exceeding this range.
- 2) Total times of reflow soldering process shall be no more than 2 times. When the second reflow soldering process is performed, intervals between the first and second reflow should be short as possible (while allowing some time for the component to return to normal temperature after the first reflow) in order to prevent the LED from absorbing moisture.
- 3) Temperature fluctuation to the LED during the pre-heating process shall be minimized. (6°C maximum)

Manual Soldering Conditions

Iron tip temp.	350 °C	(MAX.)
Soldering time and frequency	3 s	(MAX.)
	1 time	(MAX.)

Reliability Testing Result(UB,UG)

Reliability Testing Result	Applicable Standard	Testing Conditions	Duration	Failure
Room Temp. Operating Life	EIAJ ED-4701/100(101)	Ta = 25°C, I _F = Maxium Rated Current	1,000 h	0/25
Resistance to Soldering Heat	EIAJ ED-4701/300(301)	Pre-heating : 150~180°C 120s Max. Operation Heating : 230°C 40s Max. Peak Temperature : 260°C	Twice	0/25
Temperature Cycling	EIAJ ED-4701/100(105)	Minimum Rated Storage Temperature(30min) ~Normal Temperature(15min) ~Maximum Rated Storage Temperature(30min) ~Normal Temperature(15min)	200 cycles	0/25
High Temp. Operating Life	EIAJ ED-4701/100(101)	Ta = 85°C, I _F = 9mA	1,000 h	0/25
Humidity Temp. Operating Life	EIAJ ED-4701/100(102)	Ta = 60±2°C, RH = 90±5%, I _F = Maxium Rated Current	1,000 h	0/25
High Temp. Storage Life	EIAJ ED-4701/200(201)	Ta = Maximum Rated Storage Temperature	1,000 h	0/25
Low Temp. Storage Life	EIAJ ED-4701/200(202)	Ta = Minimum Rated Storage Temperature	1,000 h	0/25
Vibration, Variable Frequency	EIAJ ED-4701/400(403)	98.1m/s ² (10G), 100 ~ 2KHz sweep for 20min., XYZ each direction	2 h	0/10

Reliability Testing Result(UR)

Reliability Testing Result	Applicable Standard	Testing Conditions	Duration	Failure
Room Temp. Operating Life	EIAJ ED-4701/100(101)	Ta = 25°C, I _F = Maxium Rated Current	1,000 h	0/25
Resistance to Soldering Heat	EIAJ ED-4701/300(301)	Pre-heating : 150~180°C 120s Max. Operation Heating : 230°C 40s Max. Peak Temperature : 260°C	Twice	0/25
Temperature Cycling	EIAJ ED-4701/100(105)	Minimum Rated Storage Temperature(30min) ~Normal Temperature(15min) ~Maximum Rated Storage Temperature(30min) ~Normal Temperature(15min)	200 cycles	0/25
High Temp. Operating Life	EIAJ ED-4701/100(101)	Ta = 85°C, I _F = 30mA	1,000 h	0/25
Humidity Temp. Operating Life	EIAJ ED-4701/100(102)	Ta = 60±2°C, RH = 90±5%, I _F = Maxium Rated Current	1,000 h	0/25
High Temp. Storage Life	EIAJ ED-4701/200(201)	Ta = Maximum Rated Storage Temperature	1,000 h	0/25
Low Temp. Storage Life	EIAJ ED-4701/200(202)	Ta = Minimum Rated Storage Temperature	1,000 h	0/25
Vibration, Variable Frequency	EIAJ ED-4701/400(403)	98.1m/s ² (10G), 100 ~ 2KHz sweep for 20min., XYZ each direction	2 h	0/10

Failure Criteria

Items	Symbols	Conditions	Failure criteria
Luminous Intensity	I _V	I _F Value of each product Luminous Intensity	Testing Min. Value < Spec. Min. Value x 0.5
Forward Voltage	V _F	I _F Value of each product Forward Voltage	Testing Max. Value ≥ Spec. Max. Value x 1.2
Reverse Current	I _R	V _R = Maximum Rated Reverse Voltage V	Testing Max. Value ≥ Spec. Max. Value x 2.5
Cosmetic Appearance	-	-	Occurrence of notable decoloration, deformation and cracking

Special Notice to Customers Using the Products and Technical Information Shown in This Data Sheet

- 1) The technical information shown in the data sheets are limited to the typical characteristics and circuit examples of the referenced products. It does not constitute the warranting of industrial property nor the granting of any license.
- 2) For the purpose of product improvement, the specifications, characteristics and technical data described in the data sheets are subject to change without prior notice. Therefore it is recommended that the most updated specifications be used in your design.
- 3) When using the products described in the data sheets, please adhere to the maximum ratings for operating voltage, heat dissipation characteristics, and other precautions for use. We are not responsible for any damage which may occur if these specifications are exceeded.
- 4) The products that have been described to this catalog are manufactured so that they will be used for the electrical instrument of the benchmark (OA equipment, telecommunications equipment, AV machine, home appliance and measuring instrument).
The application of aircrafts, space borne application, transportation equipment, medical equipment and nuclear power control equipment, etc. needs a high reliability and safety, and the breakdown and the wrong operation might influence the life or the human body. Please consult us beforehand if you plan to use our product for the usages of aircrafts, space borne application, transportation equipment, medical equipment and nuclear power control equipment, etc. except OA equipment, telecommunications equipment, AV machine, home appliance and measuring instrument.
- 5) In order to export the products or technologies described in this data sheet which are under the "Foreign Exchange and Foreign Trade Control Law," it is necessary to first obtain an export permit from the Japanese government.
- 6) No part of this data sheet may be reprinted or reproduced without prior written permission from Stanley Electric Co., Ltd.
- 7) The most updated edition of this data sheet can be obtained from the address below:
<http://www.stanley-components.com>