

納入仕様書

Product Specifications

新規(含:新規部品追加)
New application (Incl. : new part(s) adding)

貴社部品名
Customer's parts name _____

仕様変更 (貴社 納入者)
Specification revision (by customer by supplier)

貴社部品番号
Customer's parts number _____

弊社部品名 UST180BMVTC5(AE)
Supplier's parts name UST180BMVTC5(E)

弊社部品番号 F-4993-305-0
Supplier's parts number F-4993-306-0

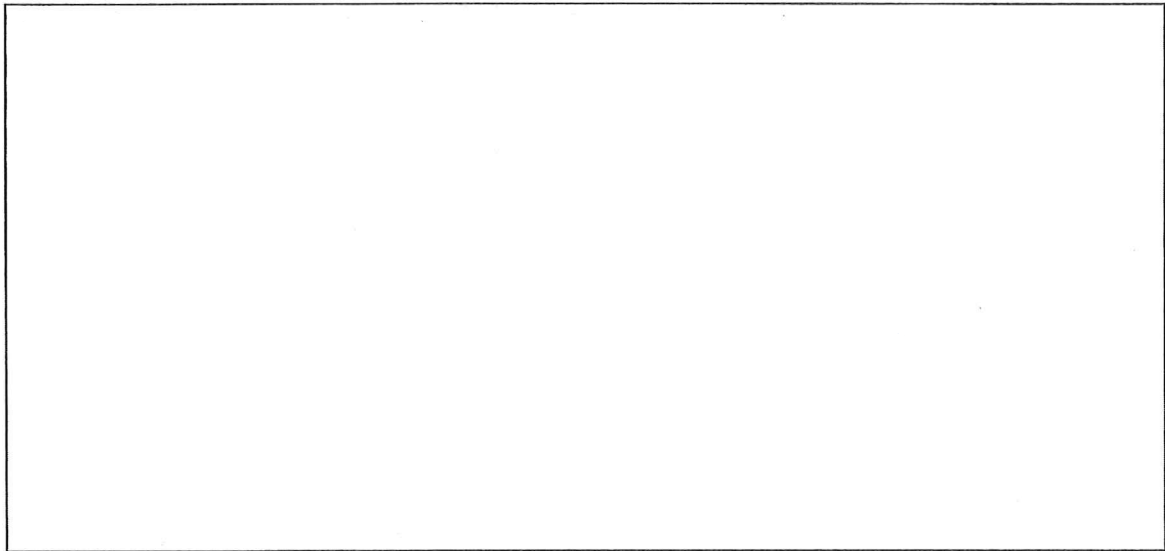

納入者 Supplier
ソニー株式会社
デバイスソリューション事業本部
Sony Corporation
Device Solutions Business Group

〒108-0075
東京都港区港南 1-7-1
1-7-1 Konan, Minato-ku, Tokyo, 108-0075 Japan

申請年月日 2014 年 02 月 07 日
Date of application (Y/M/D) _____

責任者名(押印 or 署名) 
Person responsible _____

技術担当名 小野
Person in charge of engineering _____

営業担当名 砂本
Person in charge of sales _____

仕様書番号 Spec. No.	KU22149	Ver.	1.0
--------------------	---------	------	-----

納入仕様書

Product Specifications



貴社名 : _____
Customer's name : _____

貴社部品名 : _____
Customer's parts name : _____

貴社部品番号 : _____
Customer's parts number : _____



ソニー部品名 : UST180BMVTC5(AE)
SONY parts name : UST180BMVTC5(E)

ソニー部品番号 : F-4993-305-0
SONY parts number : F-4993-306-0

承認 Approved by	確認 Checked by	作成 Prepared by
		

(/)

変更履歴
History of revisions

変更年月日 Date		変更事項 Description	承認 Approved by	作成 Prepared by
Ver.1.0	2014. 02.04	1 ST issue		

Contents 目次

1. General 概要	4
1.1 Scope 適用範囲	4
1.2 Product Category 製品カテゴリ	4
1.3 Cell Type 機種名	4
1.4 Applicable Safety Standard 適用安全規格	4
2. Cell Rating セル定格	
2.1 Nominal Capacity 公称容量	4
2.2 Rated Capacity 定格容量	4
2.3 Nominal Voltage 公称電圧	4
2.4 Charge Voltage 充電電圧	4
2.5 Cut Off Voltage 放電終止下限電圧	4
2.6 Maximum Charge Voltage 最大充電電圧	4
2.7 Continuous Maximum Charge Current 連続最大充電電流	4
2.8 Continuous Maximum Discharge Current 連続最大放電電流	4
2.9 Weight 質量	4
2.10 Allowable Environment Temperature 使用雰囲気温度	4
2.11 Energy Density エネルギー密度	4
2.12 Charge Conditions 充電条件	5
3. Shape / Dimension and Appearance 形状 / 寸法と外観	5
3.1 Shape/Dimension 形状/寸法	5
3.2 Appearance 外観	5
4. Performance 性能	5
4.1 Standard Test Condition 標準試験条件	5
4.2 Testing Instruments or Apparatus 試験計器および器具	5
4.3 Standard Charge definition 標準充電	6
4.4 Standard Discharge definition 標準放電	6
4.5 Electrical Performance 電気的性能	7
4.6 Reliability 信頼性	8
5. Identification and Marking セル表示	9
6. Outline 外形	10
7. Caution リチウムイオン電池を取扱うための注意事項	11
7.1 Prohibition Clause 禁止事項	11
7.2 Charging 充電	11
7.3 Discharging 放電	12
7.4 Storage 保存	12
7.5 Note 補足	13
8. Packing 梱包仕様	14
8.1 Packing Instruction 梱包仕様図	14
8.2 Printing Instruction for Master Carton マスターカートン印刷仕様	15
8.3 Parts name marking 品名表示	16
8.4 Packing Instruction for Pallet パレット梱包仕様	17

Lithium-Ion Battery Specifications リチウムイオンバッテリー仕様

1. General 概要

1.1 Scope 適用範囲

This specification is applied to Lithium-Ion Rechargeable Battery provided by Sony.
本仕様書はソニー製リチウムイオンバッテリーに適用する。

1.2 Product Category 製品カテゴリ

Lithium-Ion Rechargeable Battery
リチウムイオンバッテリー

1.3 Cell Type 機種名

US18650VTC5

1.4 Applicable Safety Standard 適用安全規格

UL1642: File No.MH12566
IEC62133 INR19/66

2. Cell Rating セル定格

Item 項目	Rating 定格	Note 備考
2.1 Nominal Capacity 公称容量	2600mAh	Discharge at 0.2ItA, 2.0V cutoff after Standard Charge 0.2ItA, 2.0V 終止放電での容量規格値、充電は標準充電
2.2 Rated Capacity 定格容量	2500mAh	Discharge at 0.2ItA, 2.0V cutoff after Standard Charge 0.2ItA, 2.0V 終止放電での容量規格値、充電は標準充電
2.3 Nominal Voltage 公称電圧	3.6V	
2.4 Charge Voltage 充電電圧	4.20±0.05V	
2.5 Cut Off Voltage 放電終止下限電圧	2.0V	
2.6 Maximum Charge Voltage 最大充電電圧	4.25V	
2.7 Continuous Maximum Charge Current 連続最大充電電流	4.0A	
2.8 Continuous Maximum Discharge Current 連続最大放電電流	30.0A	(温度カット 80°Cあり) (With 80 deg temperature cut)
	20.0A	(温度カット 80°Cなし) (Without 80 deg temperature cut)
2.9 Weight 質量	44.3+/-1.5 g	
2.10 Allowable Environment Temperature 使用雰囲気温度	Charge 充電	0~+45°C
	Discharge 放電	-20~+60°C
2.11 Energy Density エネルギー密度	534Wh/l	

※※ Cell condition at the shipment About 70% discharged. セル 出荷状態 約 70%放電

* Recommended charge condition. 推奨充電条件

2.12 Charge Conditions 充電条件

Temperature Range 温度範囲		Upper Limited Charging Voltage 上限充電電圧	Maximum Charging Current 最大充電電流	Charging Current Recommendation 推奨充電電流
1	Low Charging Temperature Range 低温度域 $0^{\circ}\text{C} \leq T < 10^{\circ}\text{C}$	A	4.25V	1.00A
		B	4.15V	2.00A
2	Standard Charging Temperature Range 標準温度域 $10^{\circ}\text{C} \leq T < 45^{\circ}\text{C}$	4.25V	4.00A	2.50A
3	High Charging Temperature Range 高温温度域 $45^{\circ}\text{C} < T \leq 60^{\circ}\text{C}$	4.15V	4.00A	2.00A

At Low Charging Temperature range, condition A and B are both available.
Recommended condition is B.

低温度域は条件 A または条件 B のどちらかを選択できる。推奨は条件 B。

3. Shape/Dimension and Appearance 形状 / 寸法と外観

3.1 Shape/Dimension (Ref. 6. Outline) 形状 / 寸法 (参照: 6. 外形)

Diameter of crimp クリンプ部外形	18.2 +0.15 / -0.2mm
Diameter of trunk 胴部外形	18.2 +0.15 / -0.2mm (excluding wrinkle on the tube) (チューブ収縮シワを含まない)
Total Height 総高	65.0 ± 0.2mm

3.2 Appearance 外観

It shall be free from any defects such as remarkable scratches, breaks, cracks, discoloration, leakage, or deformation. It shall be clean, and have equality and product value.

著しい傷、破損、ひび、変色、液漏れ、変形のないものとし、清潔、均一で製品価値を持つものとする。

4. Performance 性能

4.1 Standard Test Condition 標準試験条件

Test condition shall be at 23 +/- 2degC and 65 +/- 20% R.H. However, temperature 15 ~ 30°C, humidity

25 ~ 85% is acceptable as far as the test reliability is assured.

温度 23±2°C、湿度 65±20%とする。但し、疑義の生じない限りにおいては、温度 15~30°C、湿度 25~85%の範囲において試験を行って良い。

4.2 Testing Instrument or Apparatus 試験計器及び器具

4.2.1 Dimension Measuring Instrument 寸法測定器

The dimension measurement shall be implemented by instruments with equal or more precision scale of 0.01mm specified by JIS B 7502(outside micrometer) or JIS B 7503(dial gauge).

寸法測定には JIS B7502(外側マイクロメーター)、または JIS B7503(ダイヤルゲージ)に規定する目盛り 0.01mm のもの、または同等以上の精度を有する測定器を使用する。

4.2.2 Voltmeter and Ammeter 電圧計及び電流計

Voltmeters and ammeters shall be equal or more precision instruments specified by JIS C 1102

(Indication Electric Instrument Level 0.5).

JIS C1102(表示電気計器 0.5 級)に規定するもの、または同等以上の精度を有する測定器を使用する。

4.3 Standard Charge definition 標準充電

Charging at a constant voltage of 4.20V(±0.05V) and a constant current of 2.5A for 2.5 hours in 23±2°C atmosphere.

23±2°Cの雰囲気中で 4.2V (±0.05V)、2.5A の定電圧、定電流で 2.5 時間充電することをいう。

4.4 Standard Discharge definition 標準放電

Discharging at a constant current of 2.5A down to 2.5V in 23±2°C atmosphere.

23±2°Cの雰囲気中で 2.5A 定電流にて 2.5V まで放電することをいう。

4.5 Electrical Performance 電気的性能

Item 項目	Condition 条件	Specification 規格値
4.5.1 Open-Circuit Voltage 開路電圧	Shipping condition 出荷状態	3.40-3.80V and the OCV shall be within 0.04V on the same cell lot. 3.40V~3.80V 且つ同一ロット内の電圧差は 0.04V 以内
4.5.2.1 AC Impedance(1) 内部抵抗(1)	After standard charge within 3 days.(1kHz) 標準充電後 3 日以内.(1kHz)	8mΩ~18mΩ
4.5.2.2 AC Impedance(2) 内部抵抗(2)	Shipping condition(1kHz) 出荷状態(1kHz)	8mΩ~18mΩ
4.5.3.1 Capacity 放電容量	After standard charging, discharge at 0.2ItA(500mA) cut off voltage 2.0V 標準充電後、0.2ItA(500mA) 放電 2.0V 終止	2500mAh or more
4.5.3.2 Capacity(2) 放電容量(2)	After standard charging, Standard discharging 標準充電後、標準放電	2375mAh or more
4.5.4 Charge/Discharge Cycle 充電放電サイクル	Charge at 4.2V, 4.0A, Cut-off current 100mA<->Discharge at 10A, 2.5V Cut-off After 300cycles 充電 4.2V,4.0A 100mA終止 <- ->放電 10A,2.5V 終止 300 サイクル後	1750mAh or more
4.5.5 Storage Characteristic 保存特性	After standard charging, stored at 23 °C for 28 days. Remaining capacity from 10A (2.5V cut off) discharging. 標準充電後、23°C- 28 日間保存 10A(2.5Vcut)放電での残存容量	2025mAh or more
	After above measurement, Recovery capacity by discharge at 10A, 2.5V cutoff after standard charge 残存容量測定後、 標準充電、10A(2.5Vcut)放電での回復容量	2140mAh or more

<p>4.5.6 Long term Storage characteristic 長期保存特性</p>	<p>After standard Charging, store at 23 °C, 365days. Recovery capacity of standard charging and 10A(2.5V Cut off) discharging. 標準充電後、23°C-365日間保存 標準充電、10A(2.5V Cut Off)放電での回復容量</p>	<p>2025mAh or more</p>										
<p>4.5.7 Discharging Temperature Characteristic 放電温度特性</p> <p>Standard Charging Discharging: 10A Cut-off Voltage: 2.5V</p> <p>標準充電後、 10A 放電 2.5V 終止</p>	<table border="1"> <thead> <tr> <th>Discharge Temperature 放電温度</th> <th>Capacity 容量</th> </tr> </thead> <tbody> <tr> <td>-10°C</td> <td>1575mAh or more</td> </tr> <tr> <td>0°C</td> <td>1800mAh or more</td> </tr> <tr> <td>23°C</td> <td>2250mAh or more</td> </tr> <tr> <td>45°C</td> <td>2250mAh or more</td> </tr> </tbody> </table>	Discharge Temperature 放電温度	Capacity 容量	-10°C	1575mAh or more	0°C	1800mAh or more	23°C	2250mAh or more	45°C	2250mAh or more	<p>Refer to the left table 左の表参照</p>
Discharge Temperature 放電温度	Capacity 容量											
-10°C	1575mAh or more											
0°C	1800mAh or more											
23°C	2250mAh or more											
45°C	2250mAh or more											
<p>4.5.8 Charging Temperature Characteristic 充電温度特性</p> <p>Charging:4.2V 2.5A, 2.5h Standard Discharging</p> <p>充電:4.20V 2.5A,2.5h 標準放電</p>	<table border="1"> <thead> <tr> <th>Charging Temperature 充電温度</th> <th>Capacity 容量</th> </tr> </thead> <tbody> <tr> <td>0°C</td> <td>2020mAh or more</td> </tr> <tr> <td>23°C</td> <td>2375mAh or more</td> </tr> <tr> <td>45°C</td> <td>2375mAh or more</td> </tr> </tbody> </table>	Charging Temperature 充電温度	Capacity 容量	0°C	2020mAh or more	23°C	2375mAh or more	45°C	2375mAh or more	<p>Refer to the left table 左の表参照</p>		
Charging Temperature 充電温度	Capacity 容量											
0°C	2020mAh or more											
23°C	2375mAh or more											
45°C	2375mAh or more											

4.6 Reliability 信頼性

項目	条件	規格値
<p>4.6.1 Heat Cycle Test ヒートサイクルテスト</p>	<p>1) Standard charge 2) Heat cycle at 75°C6h←30min→-40°C6h for 10cycles. 3) Storage at 20±5°C for 24hours</p> <p>1) 標準充電後 2) ヒートサイクル 75°C, 6h <-30min.->-40°C,6h 10サイクル 3) その後、20+/-5°Cに24h 保管</p>	<p>No leakage, No interception 漏液、遮断なきこと</p>
<p>4.6.2 Shock Test 耐衝撃性能</p>	<p>1) Standard Charge 2) Drop the battery from 1.2m height onto P-tile for 3 times in each of X, Y and Z direction 3) Discharge at 10A, 2.5V cutoff 4) Standard charge 5) Capacity by discharge at 10A, 2.5V cutoff</p> <p>標準充電後、Pタイルへ 高さ1.2mから XYZ 各3回落下、2回目の10A放電2.5V終止容量</p>	<p>No leakage, 漏液なきこと</p> <p>2140mAh or more</p>

<p>4.6.3 Vibration Test 耐振動性能</p>	<p>1) Standard charge 2) Vibration test under the following condition Frequency and acceleration:10-60Hz, 20.6m/s² Frequency and acceleration:60-80Hz, 13.7m/s² Frequency and acceleration:80-100Hz, 6.9m/s² Frequency and acceleration:100-125Hz,3.9m/s² 3) Discharge at 10A, 2.5V cutoff 4) Standard charge 5) Capacity by discharge at 10A, 2.5V cutoff</p> <p>標準充電後、振動 2 回目の 10A 放電 2.5V 終止容量 正弦振動: 10~60Hz, 20.6m/s² 60~80Hz, 13.7m/s² 80~100Hz, 6.9m/s² 100~125Hz, 3.9m/s² 5 分スイープ, XYZ 各1時間</p>	<p>No leakage, 漏液なきこと</p> <p>2140mAh or more</p>
---------------------------------------	--	--

5. Identification and Marking (Lot Number Definition : Manufacturing Date of Cells)

セル表示 (ロット番号 : セルの製造日)

The code is printed on a surface of the can, under the tube, at two lines.

セル表示はセル側面に 2 行で印字する。



Fig.1

5.1 Manufacturer Name (Trade name) 製造社名

SE (Trade name of Sony Energy Devices Corp.)

SE (ソニーエナジー・デバイス株式会社) トレードネーム

5.2 Trade Mark (Fig.1 : US x x x x x x) 登録機種名 (Fig.1 : US x x x x x x)

US18650VTC5

5.3 Plant (Fig.1 : A for plant code) 製造所 (Fig.1 右記図 : A)

K : Sony Energy Devices Corp. Koriyama Plant.

T : Sony Energy Devices Corp. Tochigi Plant.

SG or G : Sony Electronics (Singapore)

K : ソニーエナジー・デバイス株式会社 郡山事業所 T : ソニーエナジー・デバイス株式会社 栃木事業所

SG or G: Sony Electronics (Singapore)

5.4 Specification (Fig.1. : HH for Cell Type) 仕様 (Fig.1 : HH)

C5 : US18650VTC5

5.5 Lot Number (Fig.1 : YMDDS for Manufacturing Date of Cells)

ロット、セル製造年月日 (Fig.1 : YMDDS)

Lot Number (Fig.1 : YMDDS for Manufacturing Date of Cells)

Y : Year '92 as A, Every next year is counted as B, C,... (Using an Alphabet letter)

M : Month January as A, the consecutive month as B, C,... (Using an Alphabet letter)

D : Day 01, 02, 29,30,31 (Using figures)

S : Electrode History A,B,C,.. (Using an Alphabet letter)

任意のアルファベットまたは数字

年 Y : '92 年を A として年毎に B, C,...04 年 M、05 年 N (アルファベット)

月 M : 1 月を A, として月毎に B, C,.....(アルファベット)

日 DD : 1 日を 01 として数字にて示す..... (数字)

電極履歴 S : 電極の履歴を示す。 A,B,C,.....(アルファベット)

5.6 UL Marking U L マーク (Fig.1 : Recognition Mark)

5.7 2 Dimensional Code 2 次元コード (Fig.2)

The code is on the surface of the tube

セル側面チューブ上に印字



Fig.2

6.Outline 外形

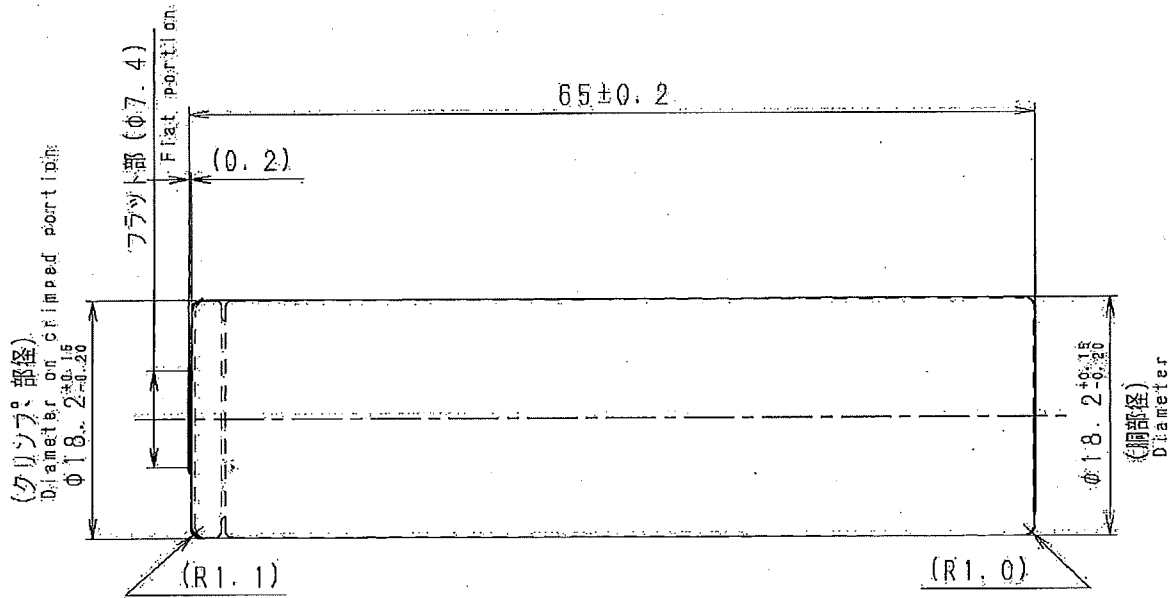

ボトム部タブ溶接禁止エリア

Prohibited area tab welding the bottom port in
 右図のように、中心部から $\phi 3$ の範囲は溶接しないこと
 As shown in the figure on the right,
 don't weld in the range of $\phi 3$ from center

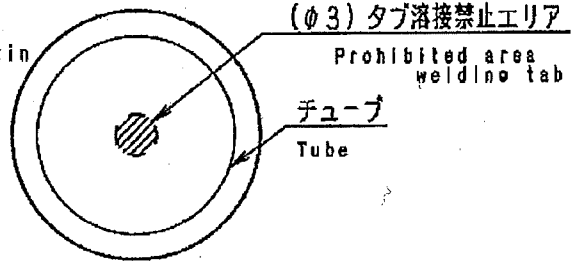

7. Caution 注意事項

Caution on usage of Lithium-Ion Rechargeable Battery.
リチウムイオン電池を取扱うための注意事項

7.1 Caution for installing the battery into the pack パック組立

*Do not combine the different Lot Number cell (the Last 5 letters and figure) into the pack
同一パック内に異なるロットナンバー(下5桁)のセルを混在させないこと

7.2 Caution for the battery and the pack

単セルおよびパックに関する注意事項

7.2.1 Charge 充電

*It shall be Constant Current-Constant Voltage (CC-CV) charging method.
定電流定電圧(CC-CV)充電方式を推奨いたします

7.2.2 Discharge 放電

*It shall avoid less than 2.5V by discharging.
放電時のカットオフ電圧は2.5Vを推奨します

7.2.3 Design of battery pack バッテリーパック設計

*It shall be the shape which cannot be connected easily to any charger other than the dedicated charger.

専用充電器以外で容易に充電できないようなコネクタ形状にすること

*It shall have the structure which cannot be connected easily for end user to apply for the other purpose.

エンドユーザーが他の目的で容易に充電できないような構造にすること

*It shall have the terminals or function which cannot easily cause external short circuit (such as chain short by necklace).

容易に外部短絡(ネックレス等によるチェーンショート)を引き起こさないような端子形状や構造とすること

*It shall not be short easily by effect of vibration or drop due to contact of internal writing materials to battery.

振動や落下によりパック内部構造由来のショートが容易に起こらないように配慮すること

7.2.4 Protection Circuit 保護回路

*The protection circuit shall be installed in the battery pack or the charger.

バッテリーパック、充電器には保護回路を設置すること

*The battery system must possess four types of protective circuits as follows.

バッテリーシステムには以下4つの保護回路を有すること

7.2.4.1 Over charging protective circuit by each block cell voltage monitoring

各ブロック電圧モニターによる過充電保護回路

By each block cell voltage monitoring, the over charging protective circuit shall operate at less than 4.250V/cell.

過充電保護回路は、各ブロック電圧モニタリングシステムにより、パック中の全セルに対し4.250V/cell以下で作動すること

7.2.4.2 Over discharging protective circuit by each block cell voltage monitoring

各ブロック電圧モニターによる過放電保護回路

By each block cell voltage monitoring, the over discharging protective circuit shall operate at 1.5V/cell to 2.0V/cell.

過放電保護回路は、各ブロック電圧モニタリングシステムにより、パック中の全セルに対し1.5V/cell to 2.0V/cellで作動すること

7.2.4.3 Over current protective circuit 過電流保護回路

The over current protective circuit shall operate charging at over 12A.

過電流保護回路は 12A を超えるまでに作動すること

The over current protective circuit or device shall operate discharging not to result in the risk or fire or explosion for over 30A discharging.

放電時の過電流保護は 30A を超えるまでに作動すること

The allowable time at each current is less than the below table. (Tentative)

各電流の放電許容時間は下記による(暫定)

Discharge current 放電電流	30~40A	~50A	~60A	~80A	~100A
Time 時間	<33sec.	<18sec.	<15sec.	<9sec.	<3sec.

7.2.4.4 Over temperature protective circuit at cell surface temperature

セル表面温度における温度保護回路

The over temperature protective circuit at high temperature side shall operate discharging until 80deg.C (Including overshoot).

放電時、高温側ではセル表面温度が 80℃になる前に温度保護が作動すること(オーバーシュート含む)

The over temperature protective circuit at high temperature side shall operate charging at until 60degC (Including overshoot).

充電時、高温側ではセル表面温度が 60℃になる前に温度保護が作動すること(オーバーシュート含む)

The over temperature protective circuit at low temperature side shall operate charging below 0degC.

充電時、低温側ではセル表面温度が 0℃以下で温度保護が作動すること

7.2.5 Cell Configuration 接続セル数

The cell configuration in the battery pack is to 2 parallels 10 series at the maximum.

パック内接続セル数は、最大 2 並列 10 直列までとする

7.3 Storage 保存

*The recommendation is SOC 20~50% for the long-term storage.

長期保存時の推奨は SOC20~50%です。

*It shall be kept in dry condition of low humidity, especially be free from high temperature (45degC or more). (Recommended Temperature 20degC., Humidity 50% or less.)

保存環境は、低湿度の乾燥状態を維持すること。特に 45℃以上とならないこと

(推奨温度; 20℃、推奨湿度; 50%以下)

*Do not storage the battery near heat sources, nor in a place subject to direct sunlight to storage in warehouse.

熱源の近く、或いは、倉庫内でも直射日光が当たる場所では保管しないこと

7.4 Prohibition Clause 禁止事項

- *Do not throw the battery into fire, nor heat the battery.
電池を温めたり、火に投げ入れたりしないこと
- *Do not disassemble nor modify the battery.
電池を分解等しないこと
- *Do not leave the battery in a place of high temperature (60degC or more).
高温(60℃以上)に置かないこと
- *Do not use the battery in a place of high temperature (60degC or more).
高温(60℃以上)で使用しないこと
- *To prevent the battery from water or moisture.
水濡れのなきこと
- *Do not add strong shock, nor drop the battery.
強い衝撃を与えたり、落下させないこと
- *Do not solder lead directly to the battery body.
セルに直接ハンダ付けしないでください
- *Do not short (+) and (-) terminal of the battery with a kind of metal.
プラス端子とマイナス端子を金属等で短絡させないこと
- *Do not reverse charge the battery.
逆充電しないこと
- *Do not penetrate the battery with a nail etc., nor make a hole in the battery.
釘を刺したり、穴を開けたりしないこと
- *Do not put the battery into a microwave oven, nor high pressure container.
電子レンジや高圧容器内に入れないこと

7.5 Note 補足

If any doubt or inconvenience on this specification arises, modification and revision shall be made per mutual agreement.

仕様に関して、なんらかの疑問・不便が発生した場合は、双方協議の上修正対応する。

8. Packing 梱包仕様

8.1 Packing Instruction 梱包仕様図

8.1.1 Boat transport specifications

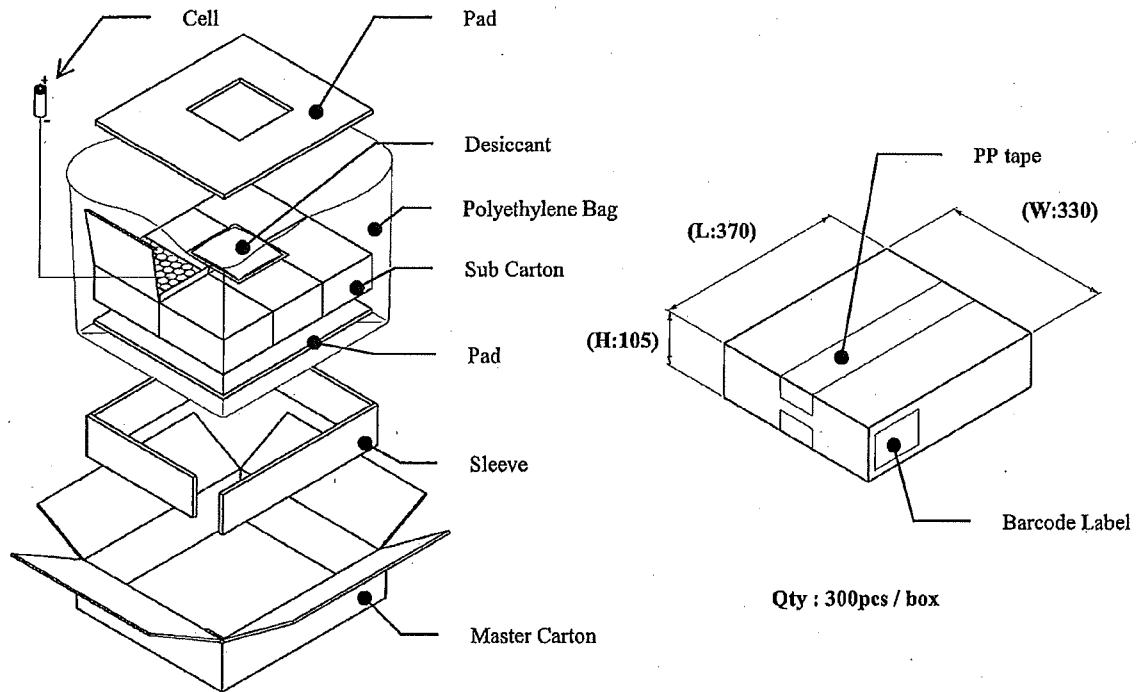

8.1.2 Air transport specifications

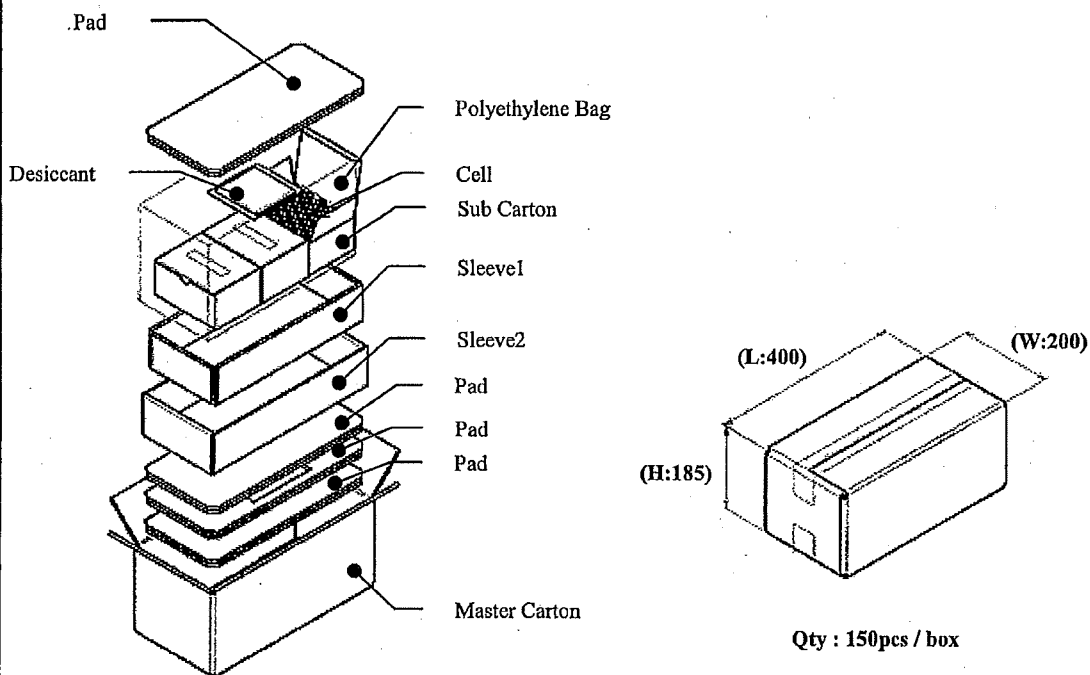

8.2 Printing Instruction for Master Carton

8.2.1 Boat transport specifications

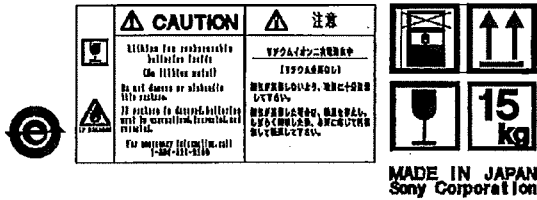
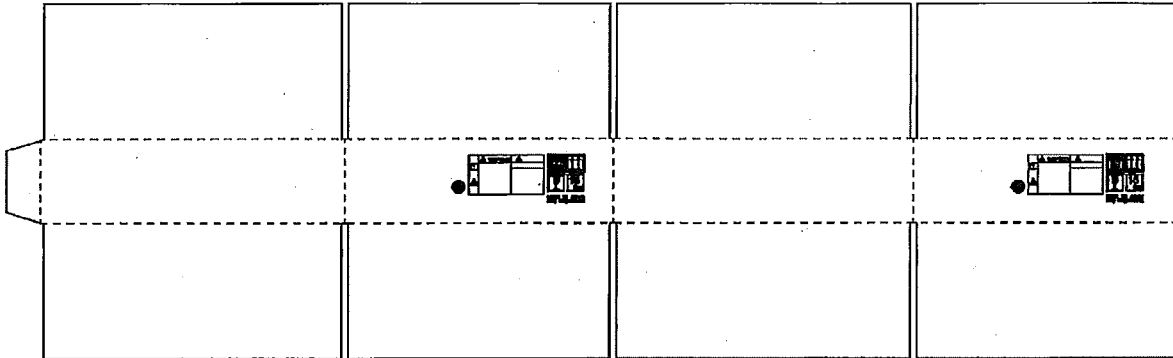

8.2.2 Air transport specifications

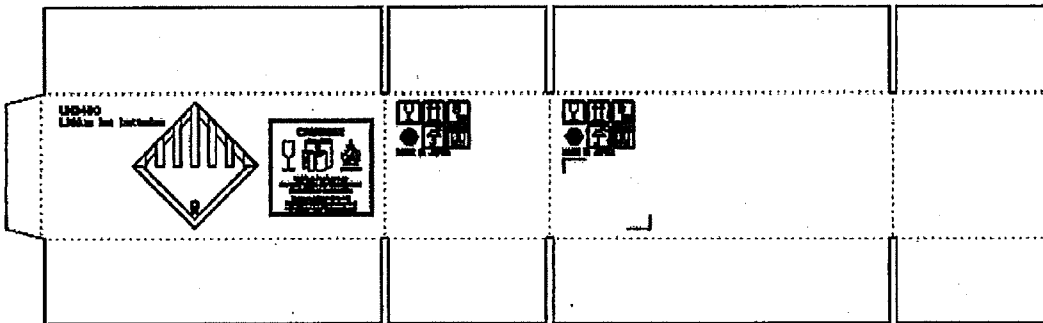



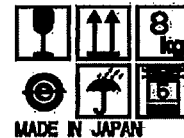
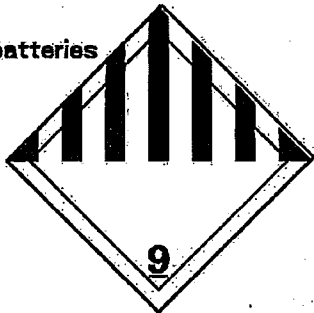

UN3480
Lithium ion batteries





8.3 Parts name marking

A part name is marked on the bar code label of master carton. This bar code label is stuck to one places of master carton.





Boat transport specifications

MODEL NAME UST180BMVTC5(AE)	MODEL CODE 
MODEL CODE F49933050	*****
CELL NAME US18650VTC5	CELL Lot No. 
CELL CODE 1-853-321-11	*****
CELL Lot No. *****	MASTER CARTON No. 
SUPPLIER Sony Corporation	*****
	MASTER CARTON Qty. 

	PACKING DATE 

	CUSTOMER CODE 

Air transport specifications

MODEL NAME UST180BMVTC5(E)	MODEL CODE 
MODEL CODE F49933060	*****
CELL NAME US18650VTC5	CELL Lot No. 
CELL CODE 1-853-321-11	*****
CELL Lot No. *****	MASTER CARTON No. 
SUPPLIER Sony Corporation	*****
	MASTER CARTON Qty. 

	PACKING DATE 

	CUSTOMER CODE 

8.4 Packing Instruction for Pallet
 8.4.1 Boat transport specifications

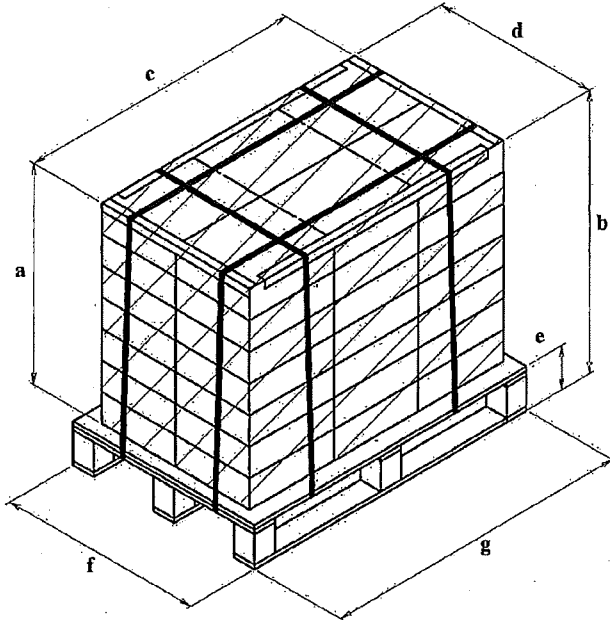

Size (mm)
 a : 735
 b : 865
 c : 1113
 d : 662
 e : 126
 f : 800
 g : 1200

8.4.2 Air transport specifications

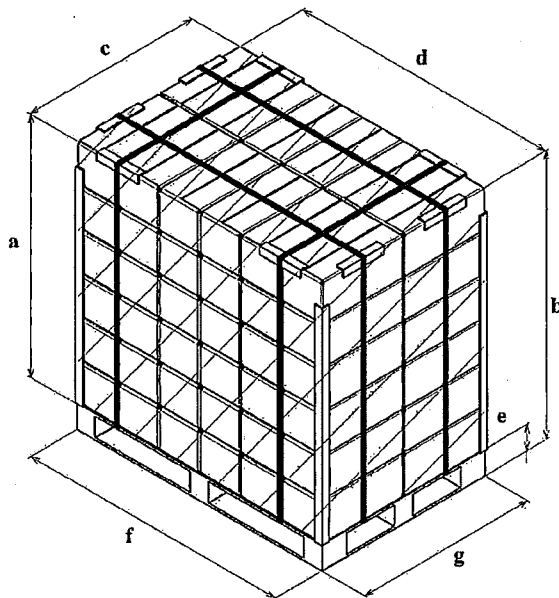

Size (mm)
 a : 959
 b : 1085
 c : 1182
 d : 792
 e : 126
 f : 800
 g : 1200

Reference

In case of the energy density is more than 400Wh/l (see 2.11), it is possibility to be subject to regulation by object country. It is recommend to confirm the contents of regulation.

As of October 2012

Japan, Electrical Appliance and Material Safety Law

<http://www.meti.go.jp/policy/consumer/seian/denan/index.htm>

Korea, Electrical Appliances Safety Control Act

<http://www.safetykorea.kr/>