

# DATA SHEET

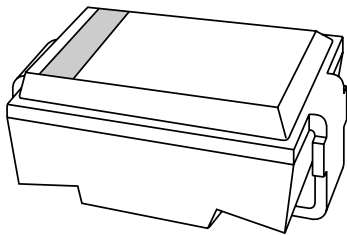

## **US1 series** SMA ultra fast low-loss controlled avalanche rectifiers

Product specification

2000 Feb 14

# SMA ultra fast low-loss controlled avalanche rectifiers

## US1 series

### FEATURES

- Glass passivated
- High maximum operating temperature
- Ideal for surface mount automotive applications
- Low leakage current
- Excellent stability
- Guaranteed avalanche energy absorption capability
- UL 94V-O classified plastic package
- Shipped in 12 mm embossed tape
- Marking: cathode, date code, type code
- Easy pick and place.

### DESCRIPTION

DO-214AC surface mountable package with glass passivated chip.

The well-defined void-free case is of a transfer-moulded thermo-setting plastic. The small rectangular package has two J bent leads.

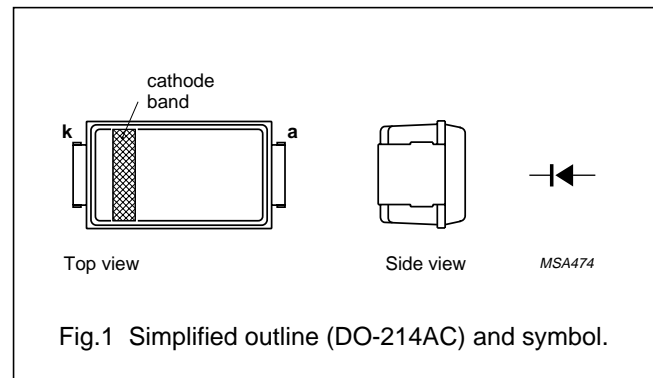

### LIMITING VALUES

In accordance with the Absolute Maximum Rating System (IEC 134).

SYMBOL	PARAMETER	CONDITIONS	MIN.	MAX.	UNIT
V <sub>RRM</sub>	repetitive peak reverse voltage				
	US1A		–	50	V
	US1B		–	100	V
	US1D		–	200	V
	US1G US1J		–	400 600	V V
V <sub>R</sub>	continuous reverse voltage				
	US1A		–	50	V
	US1B		–	100	V
	US1D		–	200	V
	US1G US1J		–	400 600	V V
V <sub>RMS</sub>	root mean square voltage				
	US1A		–	35	V
	US1B		–	70	V
	US1D		–	140	V
	US1G US1J		–	280 420	V V
I <sub>F(AV)</sub>	average forward current	averaged over any 20 ms period; T <sub>tp</sub> = 110 °C; see Fig.2	–	1	A

# SMA ultra fast low-loss controlled avalanche rectifiers

## US1 series

SYMBOL	PARAMETER	CONDITIONS	MIN.	MAX.	UNIT
$I_{FSM}$	non-repetitive peak forward current	$t = 8.3$ ms half sine wave; $T_j = 25$ °C prior to surge; $V_R = V_{RRMmax}$	–	25	A
$T_{stg}$	storage temperature		–65	+175	°C
$T_j$	junction temperature	See Fig.3	–65	+175	°C

### ELECTRICAL CHARACTERISTICS

$T_j = 25$  °C unless otherwise specified.

SYMBOL	PARAMETER	CONDITIONS	TYP.	MAX.	UNIT
$V_F$	forward voltage	$I_F = 1$ A; see Fig.4	–	1.1	V
	US1A to US1G				
	US1J	see Fig.5	–	1.4	V
$I_R$	reverse current	$V_R = V_{RRMmax}$ ; see Figs 6 and 7	–	10	µA
		$V_R = V_{RRMmax}$ ; $T_j = 165$ °C; see Figs 6 and 7	–	50	µA
$t_{rr}$	reverse recovery time	when switched from $I_F = 0.5$ A to $I_R = 1$ A; measured at $I_R = 0.25$ A; see Fig.12	–	50	ns
$C_d$	diode capacitance	$V_R = 4$ V; $f = 1$ MHz; see Fig.8	14	–	pF
	US1A to US1G				
	US1J	see Fig.9	10	–	pF

### THERMAL CHARACTERISTICS

SYMBOL	PARAMETER	CONDITIONS	VALUE	UNIT
$R_{th\ j-tp}$	thermal resistance from junction to tie-point; see Fig.10		27	K/W
$R_{th\ j-a}$	thermal resistance from junction to ambient	note 1	100	K/W
		note 2	150	K/W

#### Notes

1. Device mounted on  $Al_2O_3$  printed-circuit board, 0.7 mm thick; thickness of copper  $\geq 35$  µm.
2. Device mounted on epoxy-glass printed-circuit board, 1.5 mm thick; thickness of copper  $\geq 40$  µm. For more information please refer to the 'General Part of associated Handbook'.

SMA ultra fast low-loss controlled avalanche rectifiers

US1 series

GRAPHICAL DATA

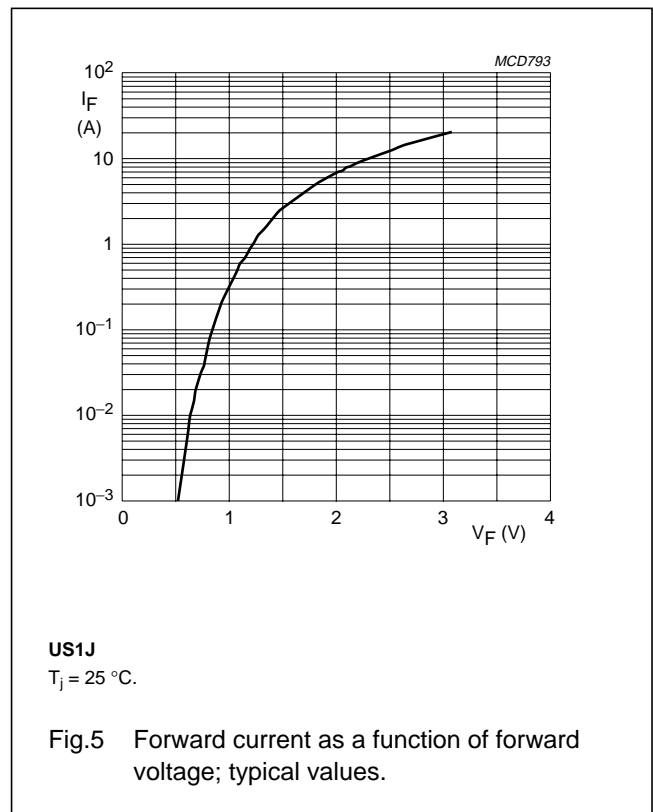
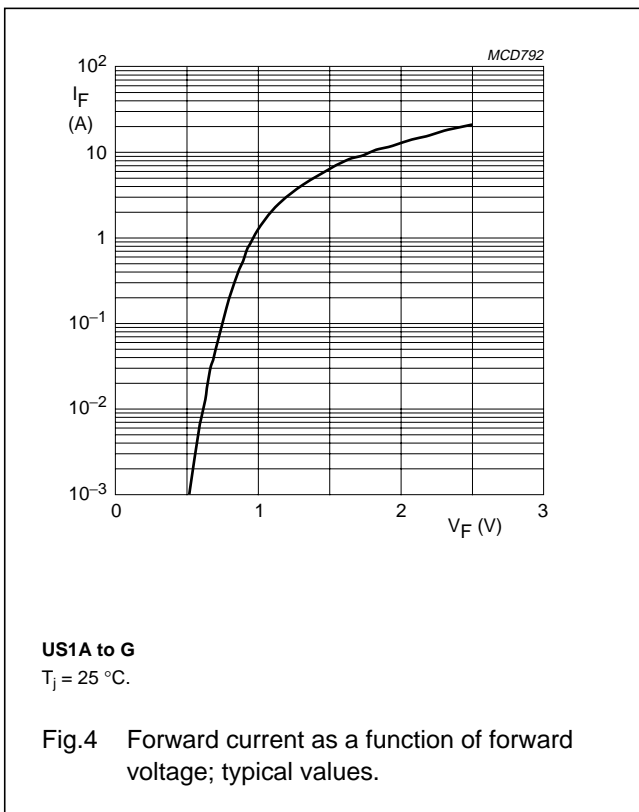
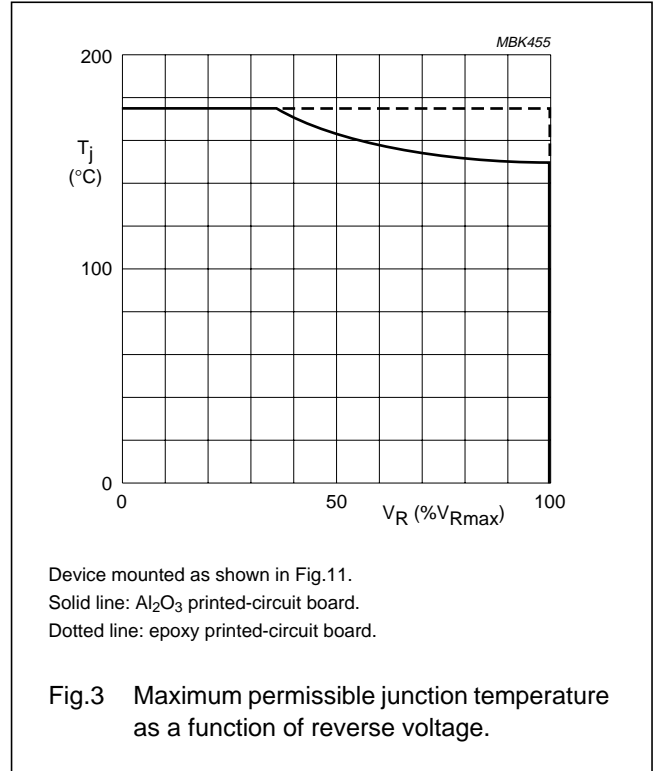
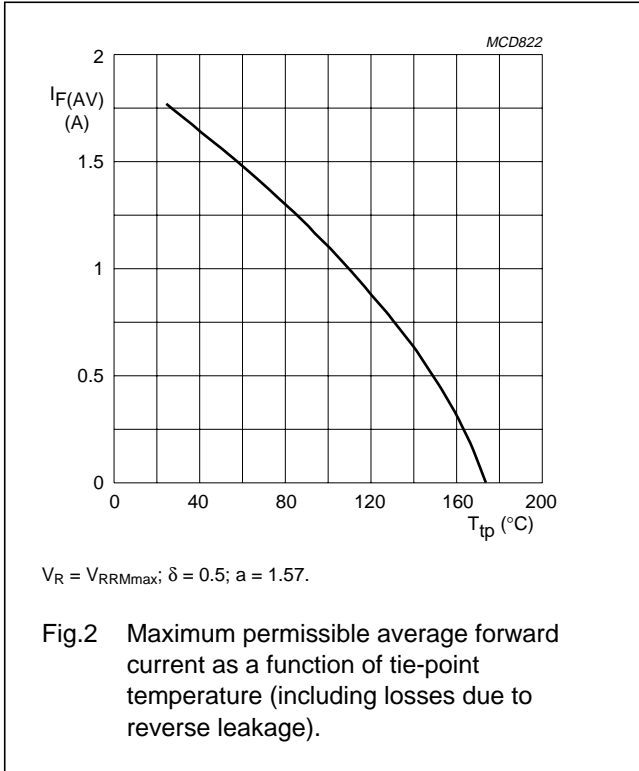

SMA ultra fast low-loss  
controlled avalanche rectifiers

US1 series

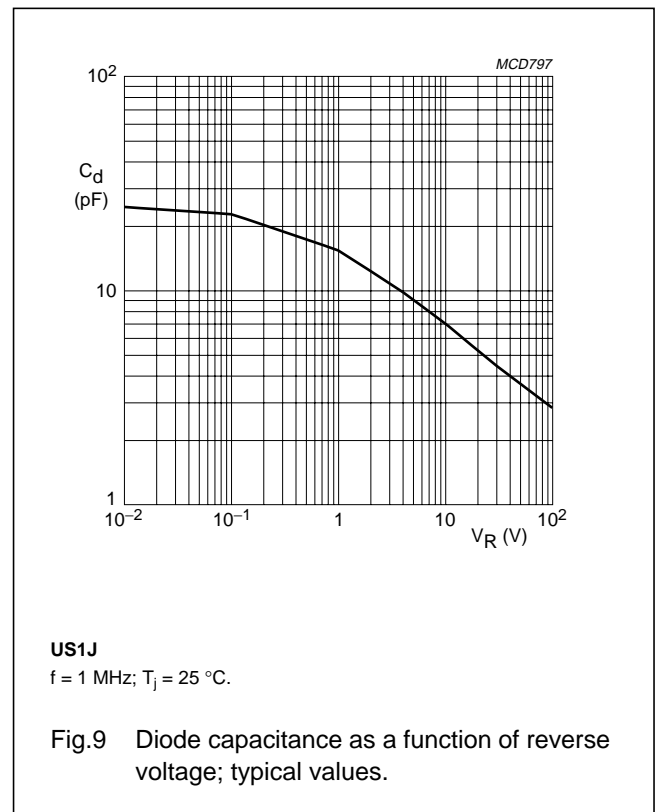
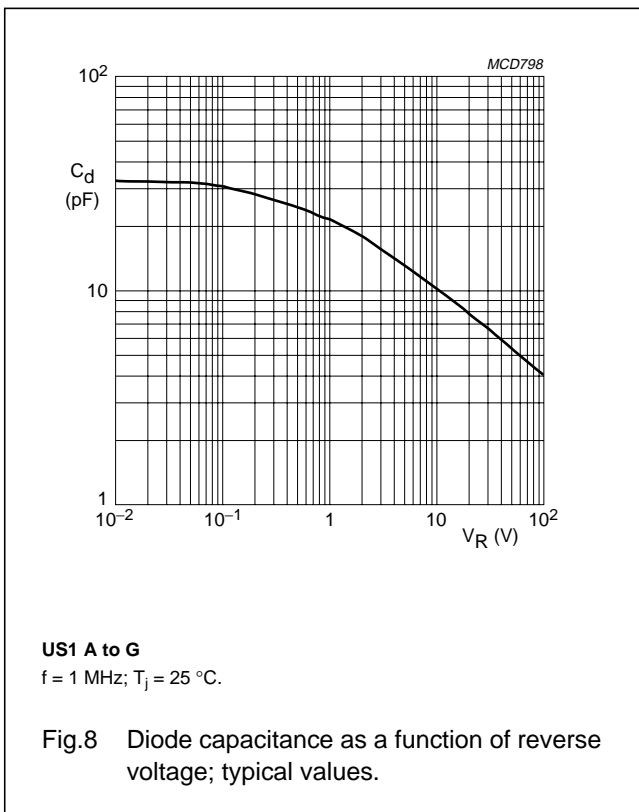
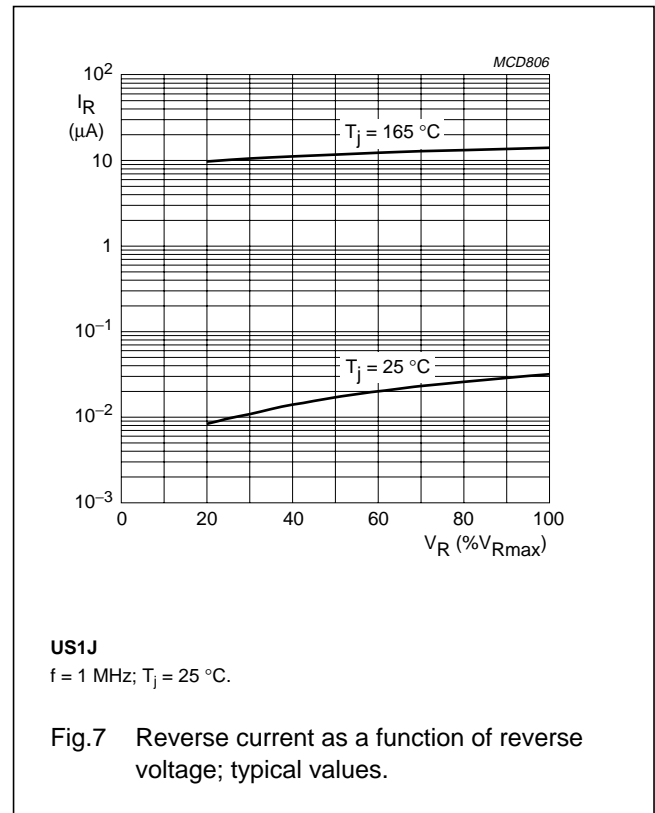
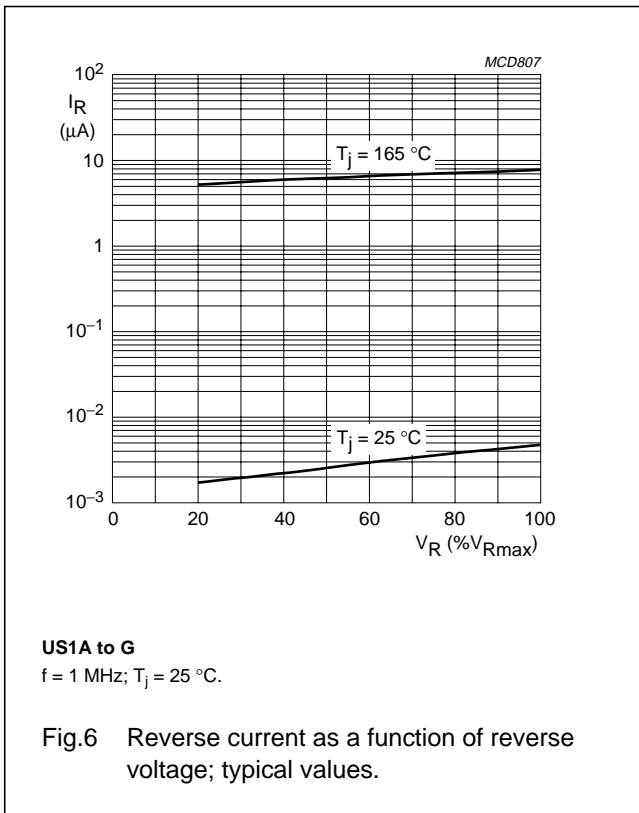

SMA ultra fast low-loss controlled avalanche rectifiers

US1 series

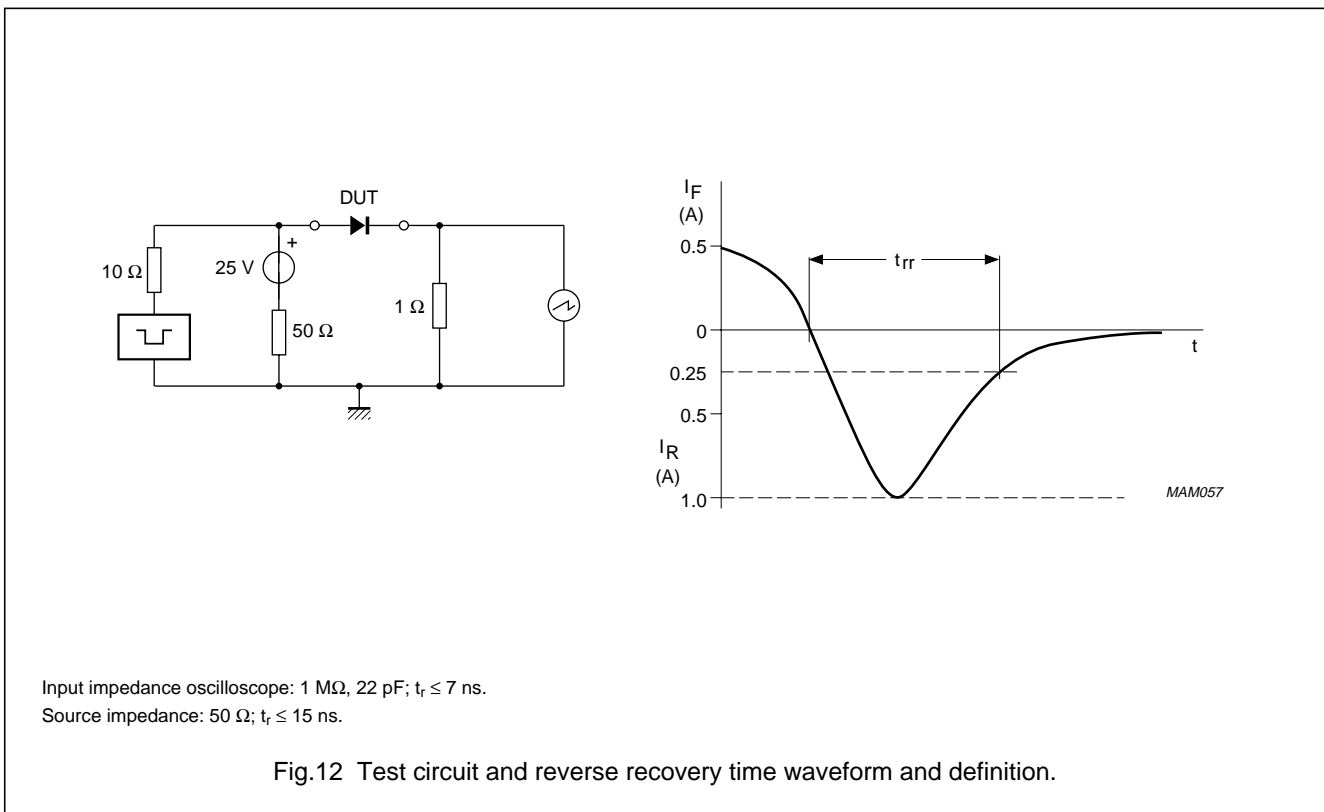
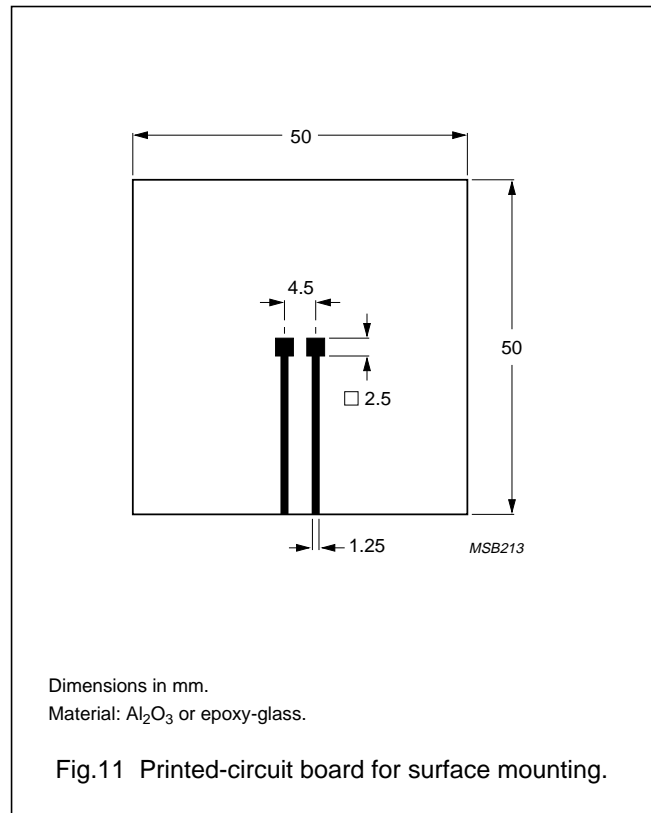
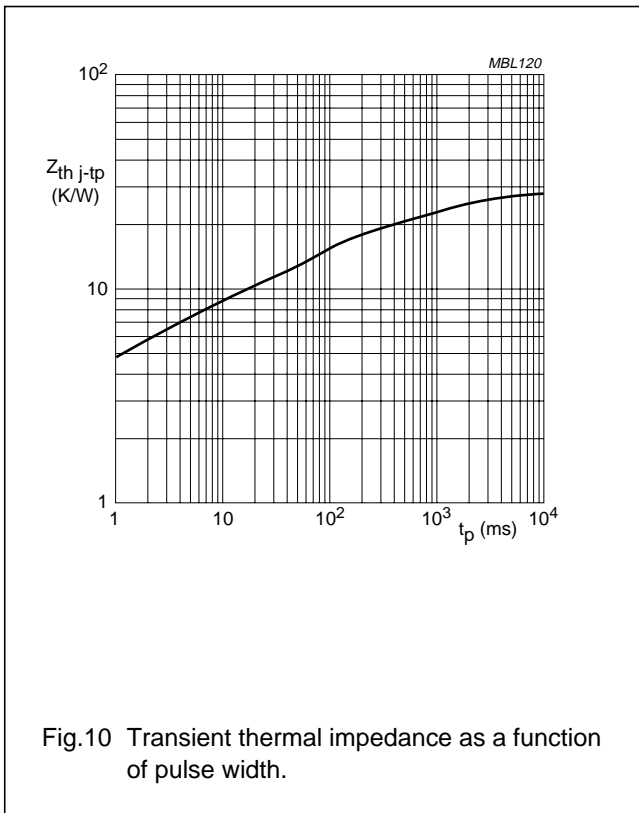

SMA ultra fast low-loss  
controlled avalanche rectifiers

US1 series

PACKAGE OUTLINE

Transfer-moulded thermo-setting plastic small rectangular surface mounted package;  
2 connectors

SOD124

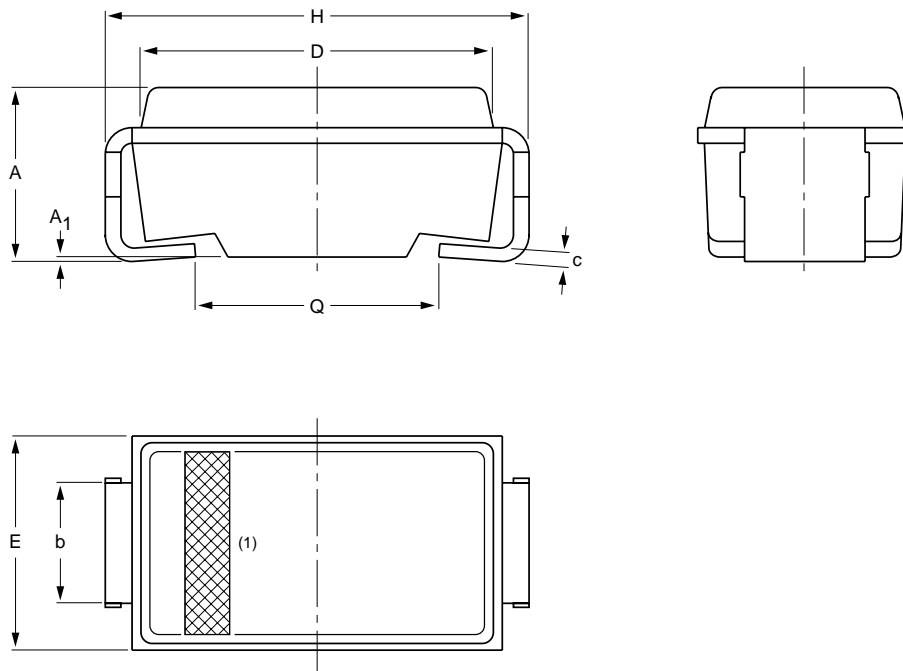

DIMENSIONS (mm are the original dimensions)

UNIT	A	A <sub>1</sub>	b	c	D	E	H	Q
mm	2.3 2.0	0.05	1.6 1.4	0.2	4.5 4.3	2.8 2.4	5.5 5.1	3.3 2.7

Note

1. The marking band indicates the cathode.

OUTLINE VERSION	REFERENCES			EUROPEAN PROJECTION	ISSUE DATE
	IEC	JEDEC	EIAJ		
SOD124		DO-214AC			99-10-22

# SMA ultra fast low-loss controlled avalanche rectifiers

## US1 series

### DEFINITIONS

<b>Data sheet status</b>	
Objective specification	This data sheet contains target or goal specifications for product development.
Preliminary specification	This data sheet contains preliminary data; supplementary data may be published later.
Product specification	This data sheet contains final product specifications.
<b>Limiting values</b>	
Limiting values given are in accordance with the Absolute Maximum Rating System (IEC 60134). Stress above one or more of the limiting values may cause permanent damage to the device. These are stress ratings only and operation of the device at these or at any other conditions above those given in the Characteristics sections of the specification is not implied. Exposure to limiting values for extended periods may affect device reliability.	
<b>Application information</b>	
Where application information is given, it is advisory and does not form part of the specification.	

### LIFE SUPPORT APPLICATIONS

These products are not designed for use in life support appliances, devices, or systems where malfunction of these products can reasonably be expected to result in personal injury. Philips customers using or selling these products for use in such applications do so at their own risk and agree to fully indemnify Philips for any damages resulting from such improper use or sale.



SMA ultra fast low-loss  
controlled avalanche rectifiers

US1 series

---

**NOTES**

SMA ultra fast low-loss  
controlled avalanche rectifiers

US1 series

---

**NOTES**

SMA ultra fast low-loss  
controlled avalanche rectifiers

US1 series

---

**NOTES**

# Philips Semiconductors – a worldwide company

**Argentina:** see South America

**Australia:** 3 Figtree Drive, HOMEBUSH, NSW 2140,  
Tel. +61 2 9704 8141, Fax. +61 2 9704 8139

**Austria:** Computerstr. 6, A-1101 WIEN, P.O. Box 213,  
Tel. +43 1 60 101 1248, Fax. +43 1 60 101 1210

**Belarus:** Hotel Minsk Business Center, Bld. 3, r. 1211, Volodarski Str. 6,  
220050 MINSK, Tel. +375 172 20 0733, Fax. +375 172 20 0773

**Belgium:** see The Netherlands

**Brazil:** see South America

**Bulgaria:** Philips Bulgaria Ltd., Energoproject, 15th floor,  
51 James Bourchier Blvd., 1407 SOFIA,  
Tel. +359 2 68 9211, Fax. +359 2 68 9102

**Canada:** PHILIPS SEMICONDUCTORS/COMPONENTS,  
Tel. +1 800 234 7381, Fax. +1 800 943 0087

**China/Hong Kong:** 501 Hong Kong Industrial Technology Centre,  
72 Tat Chee Avenue, Kowloon Tong, HONG KONG,  
Tel. +852 2319 7888, Fax. +852 2319 7700

**Colombia:** see South America

**Czech Republic:** see Austria

**Denmark:** Sydhavnsgade 23, 1780 COPENHAGEN V,  
Tel. +45 33 29 3333, Fax. +45 33 29 3905

**Finland:** Sinikalliontie 3, FIN-02630 ESPOO,  
Tel. +358 9 615 800, Fax. +358 9 6158 0920

**France:** 51 Rue Carnot, BP317, 92156 SURESNES Cedex,  
Tel. +33 1 4099 6161, Fax. +33 1 4099 6427

**Germany:** Hammerbrookstraße 69, D-20097 HAMBURG,  
Tel. +49 40 2353 60, Fax. +49 40 2353 6300

**Hungary:** see Austria

**India:** Philips INDIA Ltd, Band Box Building, 2nd floor,  
254-D, Dr. Annie Besant Road, Worli, MUMBAI 400 025,  
Tel. +91 22 493 8541, Fax. +91 22 493 0966

**Indonesia:** PT Philips Development Corporation, Semiconductors Division,  
Gedung Philips, Jl. Buncit Raya Kav.99-100, JAKARTA 12510,  
Tel. +62 21 794 0040 ext. 2501, Fax. +62 21 794 0080

**Ireland:** Newstead, Clonskeagh, DUBLIN 14,  
Tel. +353 1 7640 000, Fax. +353 1 7640 200

**Israel:** RAPAC Electronics, 7 Kehilat Saloniki St, PO Box 18053,  
TEL AVIV 61180, Tel. +972 3 645 0444, Fax. +972 3 649 1007

**Italy:** PHILIPS SEMICONDUCTORS, Via Casati, 23 - 20052 MONZA (MI),  
Tel. +39 039 203 6838, Fax +39 039 203 6800

**Japan:** Philips Bldg 13-37, Kohnan 2-chome, Minato-ku,  
TOKYO 108-8507, Tel. +81 3 3740 5130, Fax. +81 3 3740 5057

**Korea:** Philips House, 260-199 Itaewon-dong, Yongsan-ku, SEOUL,  
Tel. +82 2 709 1412, Fax. +82 2 709 1415

**Malaysia:** No. 76 Jalan Universiti, 46200 PETALING JAYA, SELANGOR,  
Tel. +60 3 750 5214, Fax. +60 3 757 4880

**Mexico:** 5900 Gateway East, Suite 200, EL PASO, TEXAS 79905,  
Tel. +9-5 800 234 7381, Fax +9-5 800 943 0087

**Middle East:** see Italy

**Netherlands:** Postbus 90050, 5600 PB EINDHOVEN, Bldg. VB,  
Tel. +31 40 27 82785, Fax. +31 40 27 88399

**New Zealand:** 2 Wagener Place, C.P.O. Box 1041, AUCKLAND,  
Tel. +64 9 849 4160, Fax. +64 9 849 7811

**Norway:** Box 1, Manglerud 0612, OSLO,  
Tel. +47 22 74 8000, Fax. +47 22 74 8341

**Pakistan:** see Singapore

**Philippines:** Philips Semiconductors Philippines Inc.,  
106 Valero St. Salcedo Village, P.O. Box 2108 MCC, MAKATI,  
Metro MANILA, Tel. +63 2 816 6380, Fax. +63 2 817 3474

**Poland:** Al.Jerozolimskie 195 B, 02-222 WARSAW,  
Tel. +48 22 5710 000, Fax. +48 22 5710 001

**Portugal:** see Spain

**Romania:** see Italy

**Russia:** Philips Russia, Ul. Usatcheva 35A, 119048 MOSCOW,  
Tel. +7 095 755 6918, Fax. +7 095 755 6919

**Singapore:** Lorong 1, Toa Payoh, SINGAPORE 319762,  
Tel. +65 350 2538, Fax. +65 251 6500

**Slovakia:** see Austria

**Slovenia:** see Italy

**South Africa:** S.A. PHILIPS Pty Ltd., 195-215 Main Road Martindale,  
2092 JOHANNESBURG, P.O. Box 58088 Newville 2114,  
Tel. +27 11 471 5401, Fax. +27 11 471 5398

**South America:** Al. Vicente Pinzon, 173, 6th floor,  
04547-130 SÃO PAULO, SP, Brazil,  
Tel. +55 11 821 2333, Fax. +55 11 821 2382

**Spain:** Balmes 22, 08007 BARCELONA,  
Tel. +34 93 301 6312, Fax. +34 93 301 4107

**Sweden:** Kottbygatan 7, Akalla, S-16485 STOCKHOLM,  
Tel. +46 8 5985 2000, Fax. +46 8 5985 2745

**Switzerland:** Allmendstrasse 140, CH-8027 ZÜRICH,  
Tel. +41 1 488 2741 Fax. +41 1 488 3263

**Taiwan:** Philips Semiconductors, 6F, No. 96, Chien Kuo N. Rd., Sec. 1,  
TAIPEI, Taiwan Tel. +886 2 2134 2886, Fax. +886 2 2134 2874

**Thailand:** PHILIPS ELECTRONICS (THAILAND) Ltd.,  
209/2 Sanpavuth-Bangna Road Prakanong, BANGKOK 10260,  
Tel. +66 2 745 4090, Fax. +66 2 398 0793

**Turkey:** Yukari Dudullu, Org. San. Blg., 2.Cad. Nr. 28 81260 Umraniye,  
ISTANBUL, Tel. +90 216 522 1500, Fax. +90 216 522 1813

**Ukraine:** PHILIPS UKRAINE, 4 Patrice Lumumba str., Building B, Floor 7,  
252042 KIEV, Tel. +380 44 264 2776, Fax. +380 44 268 0461

**United Kingdom:** Philips Semiconductors Ltd., 276 Bath Road, Hayes,  
MIDDLESEX UB3 5BX, Tel. +44 208 730 5000, Fax. +44 208 754 8421

**United States:** 811 East Arques Avenue, SUNNYVALE, CA 94088-3409,  
Tel. +1 800 234 7381, Fax. +1 800 943 0087

**Uruguay:** see South America

**Vietnam:** see Singapore

**Yugoslavia:** PHILIPS, Trg N. Pasica 5/v, 11000 BEOGRAD,  
Tel. +381 11 3341 299, Fax.+381 11 3342 553

**For all other countries apply to:** Philips Semiconductors,  
International Marketing & Sales Communications, Building BE-p, P.O. Box 218,  
5600 MD EINDHOVEN, The Netherlands, Fax. +31 40 27 24825

**Internet:** <http://www.semiconductors.philips.com>

© Philips Electronics N.V. 2000

SCA 69

All rights are reserved. Reproduction in whole or in part is prohibited without the prior written consent of the copyright owner.

The information presented in this document does not form part of any quotation or contract, is believed to be accurate and reliable and may be changed without notice. No liability will be accepted by the publisher for any consequence of its use. Publication thereof does not convey nor imply any license under patent- or other industrial or intellectual property rights.

Printed in The Netherlands

603502/250/01/pp12

Date of release: 2000 Feb 14

Document order number: 9397 750 06784

*Let's make things better.*

**Philips**  
Semiconductors



**PHILIPS**