



UT2301

Power MOSFET

-2.8A, -20V P-CHANNEL ENHANCEMENT MODE POWER MOSFET

■ DESCRIPTION

The UTC **UT2301** is P-channel enhancement mode power MOSFET, designed in serried ranks. With fast switching speed, low on-resistance, favorable stabilization.

Used in commercial and industrial surface mount applications and suited for low voltage applications such as DC/DC converters.

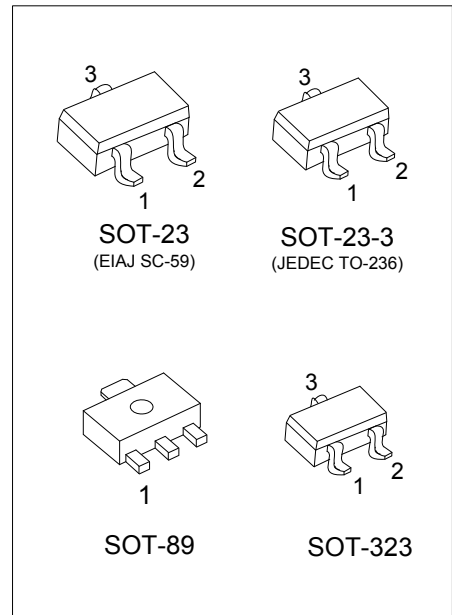

■ SYMBOL

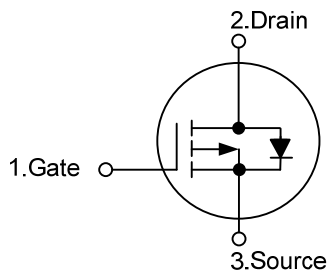

SOT-89

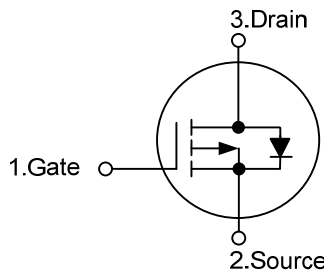

SOT-23-3 / SOT-23 / SOT-323

■ ORDERING INFORMATION

Ordering Number		Package	Pin Assignment			Packing
Lead Free	Halogen Free		1	2	3	
UT2301L-AB3-R	UT2301G-AB3-R	SOT-89	G	D	S	Tape Reel
UT2301L-AE2-R	UT2301G-AE2-R	SOT-23-3	G	S	D	Tape Reel
UT2301L-AE3-R	UT2301G-AE3-R	SOT-23	G	S	D	Tape Reel
UT2301L-AL3-R	UT2301G-AL3-R	SOT-323	G	S	D	Tape Reel

Note: Pin Assignment: G: Gate D: Drain S: Source

<p>UT2301G-AB3-R</p> <p>(1)Packing Type</p> <p>(2)Package Type</p> <p>(3)Green Package</p>	<p>(1) R: Tape Reel</p> <p>(2) AB3: SOT-89, AE2: SOT-23-3, AE3: SOT-23 AL3: SOT-323</p> <p>(3) G: Halogen Free and Lead Free, L: Lead Free</p>
--	--

■ MARKING

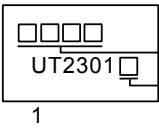
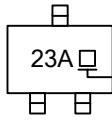
SOT-89	SOT-23-3 / SOT-23 / SOT-323
 <p>The diagram shows a rectangular package with a date code of three squares, the part number 'UT2301', and a small square. The number '1' is printed below the package.</p> <p>→ Date Code → L: Lead Free → G: Halogen Free</p>	 <p>The diagram shows a package with the marking '23A' and a small square.</p> <p>→ L: Lead Free → G: Halogen Free</p>

■ ABSOLUTE MAXIMUM RATINGS ($T_A = 25^\circ\text{C}$, unless otherwise specified)

PARAMETER		SYMBOL	RATING	UNIT
Drain-Source Voltage		V_{DSS}	-20	V
Gate-Source Voltage		V_{GSS}	± 8	V
Continuous Drain Current	Continuous	I_D	-2.8	A
Pulsed Drain Current	Pulsed (Note 2)	I_{DM}	-8.4	A
Avalanche Energy	Single Pulsed (Note 3)	E_{AS}	20.5	mJ
Total Power Dissipation	SOT-89	P_D	0.8	W
	SOT-23-3/SOT-323		0.5	W
	SOT-23		0.6	W
Junction Temperature		T_J	+150	$^\circ\text{C}$
Storage Temperature		T_{STG}	-55 ~ +150	$^\circ\text{C}$

Notes: 1. Absolute maximum ratings are those values beyond which the device could be permanently damaged.

Absolute maximum ratings are stress ratings only and functional device operation is not implied.

2. Repetitive Rating : Pulse width limited by maximum junction temperature.

3. $L=16\text{mH}$, $I_{AS}=-1.6\text{A}$, $V_{DD}=-20\text{V}$, $R_G=25\Omega$, Starting $T_J=25^\circ\text{C}$.

■ THERMAL DATA

PARAMETER		SYMBOL	RATING	UNIT
Junction to Ambient	SOT-89	θ_{JA}	156	$^\circ\text{C/W}$
	SOT-23-3/SOT-323		250	$^\circ\text{C/W}$
	SOT-23		208	$^\circ\text{C/W}$

Note: Device mounted on FR-4 substrate PC board, 2oz copper, with 1inch square copper plate.

■ ELECTRICAL CHARACTERISTICS (T_J=25°C, unless otherwise specified)

PARAMETER		SYMBOL	TEST CONDITIONS	MIN	TYP	MAX	UNIT
OFF CHARACTERISTICS							
Drain-Source Breakdown Voltage		BV _{DSS}	V _{GS} =0V, I _D =-250μA	-20			V
Drain-Source Leakage Current		I _{DSS}	V _{DS} =-16V, V _{GS} =0V			-1	μA
Gate-Source Leakage Current		I _{GSS}	V _{GS} =±8V, V _{DS} =0V			±100	nA
ON CHARACTERISTICS							
Gate Threshold Voltage		V _{GS(TH)}	V _{DS} =V _{GS} , I _D =-250μA	-0.45			V
Static Drain-Source On-State Resistance (Note 1)	SOT-23-3/SOT-23	R _{DS(ON)}	V _{GS} =-4.5V, I _D =-2.8A			130	mΩ
	SOT-89		V _{GS} =-2.5V, I _D =-2.0A			190	mΩ
	SOT-323		V _{GS} =-4.5V, I _D =-2.8A			160	mΩ
			V _{GS} =-2.5V, I _D =-2.0A			281	mΩ
DYNAMIC CHARACTERISTICS							
Input Capacitance		C _{ISS}	V _{GS} =0V, V _{DS} =-10V, f=1.0MHz		255		pF
Output Capacitance		C _{OSS}			66		pF
Reverse Transfer Capacitance		C _{RSS}			56		pF
SWITCHING CHARACTERISTICS							
Total Gate Charge (Note 1)		Q _G	V _{DS} =-16V, V _{GS} =-10V, I _D =-2.8A, I _D =-1mA		12		nC
Gate-Source Charge		Q _{GS}			1		nC
Gate-Drain Charge		Q _{GD}			2		nC
Turn-ON Delay Time (Note 1)		t _{D(ON)}	V _{DS} =-10V, V _{GS} =-10V, I _D =-2.8A, R _G =6Ω		3		ns
Turn-ON Rise Time		t _R			15		ns
Turn-OFF Delay Time		t _{D(OFF)}			15		ns
Turn-OFF Fall Time		t _F			21		ns
SOURCE- DRAIN DIODE RATINGS AND CHARACTERISTICS							
Maximum Continuous Drain-Source Diode Forward Current		I _S				-1.6	A
Maximum Body-Diode Pulsed Current		I _{SM}				-8.4	A
Drain-Source Diode Forward Voltage (Note 1)		V _{SD}	V _{GS} =0V, I _S =-1.6A		-0.8	-1.2	V

Notes: 1. Pulse Test : Pulse width ≤ 300μs, Duty cycle ≤ 2%.

2. Essentially independent of operating temperature.

■ TYPICAL CHARACTERISTICS

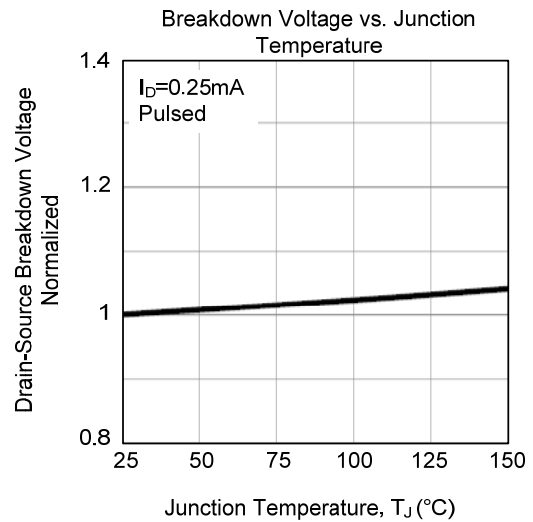
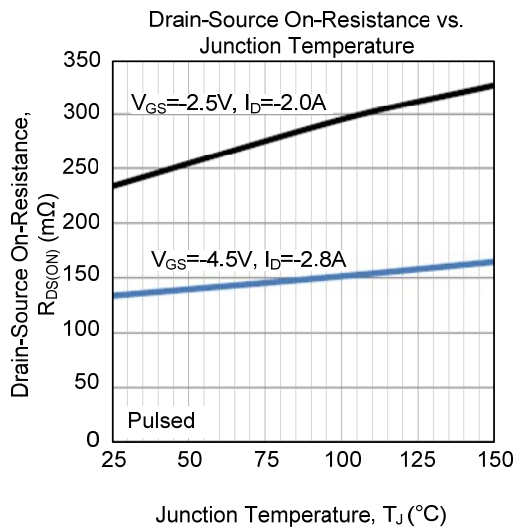
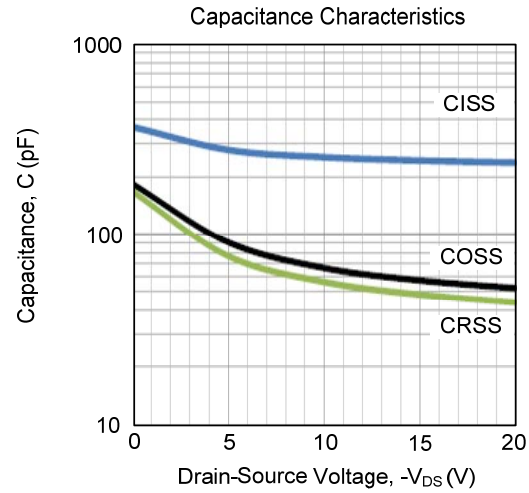
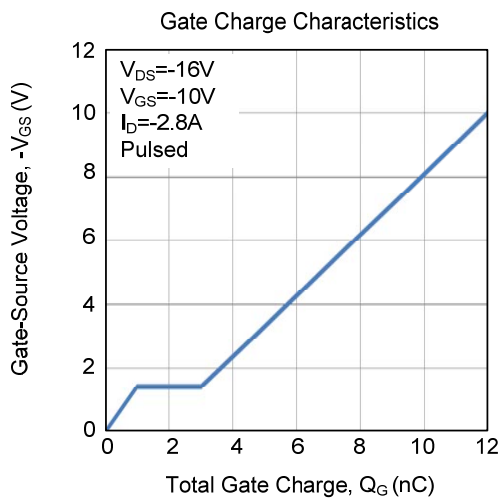
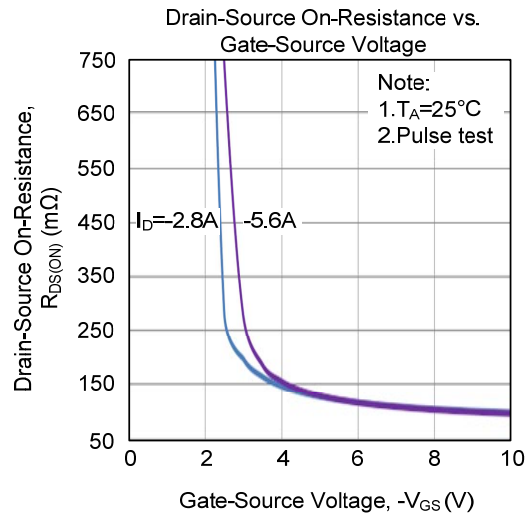
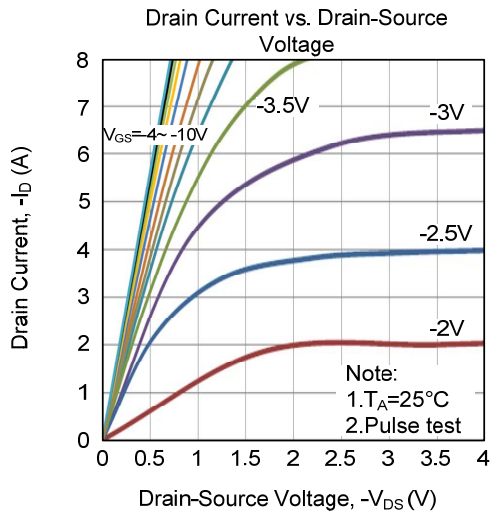

■ TYPICAL CHARACTERISTICS (Cont.)

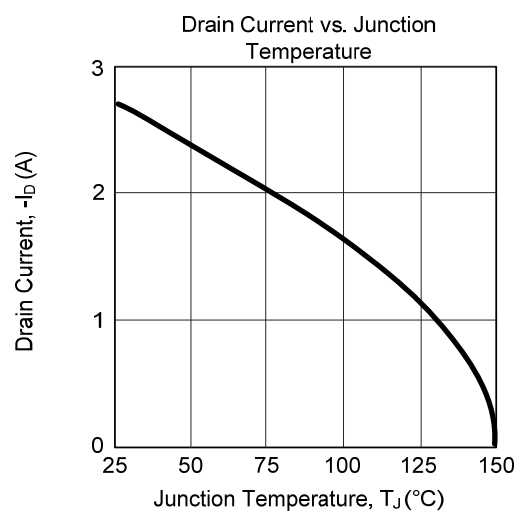
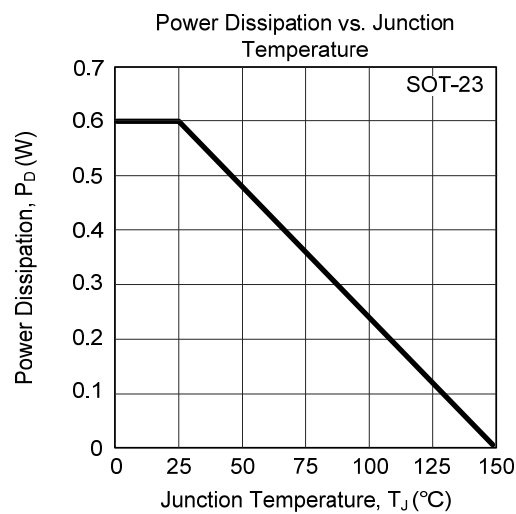
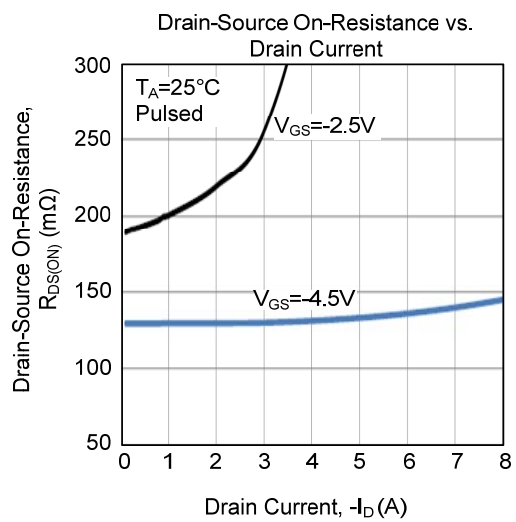
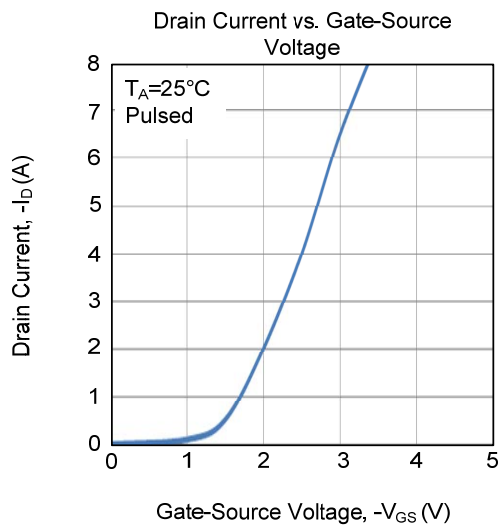
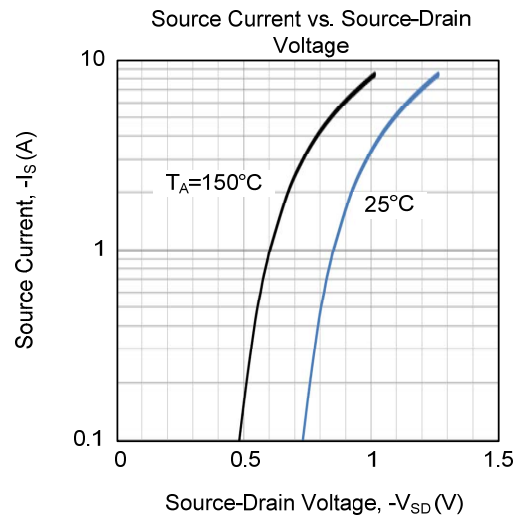
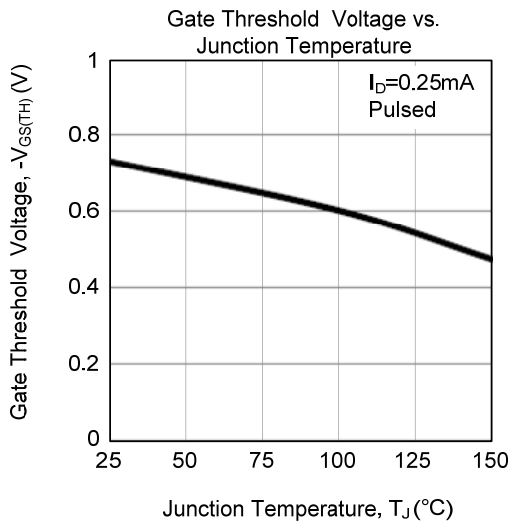

■ TYPICAL CHARACTERISTICS (Cont.)

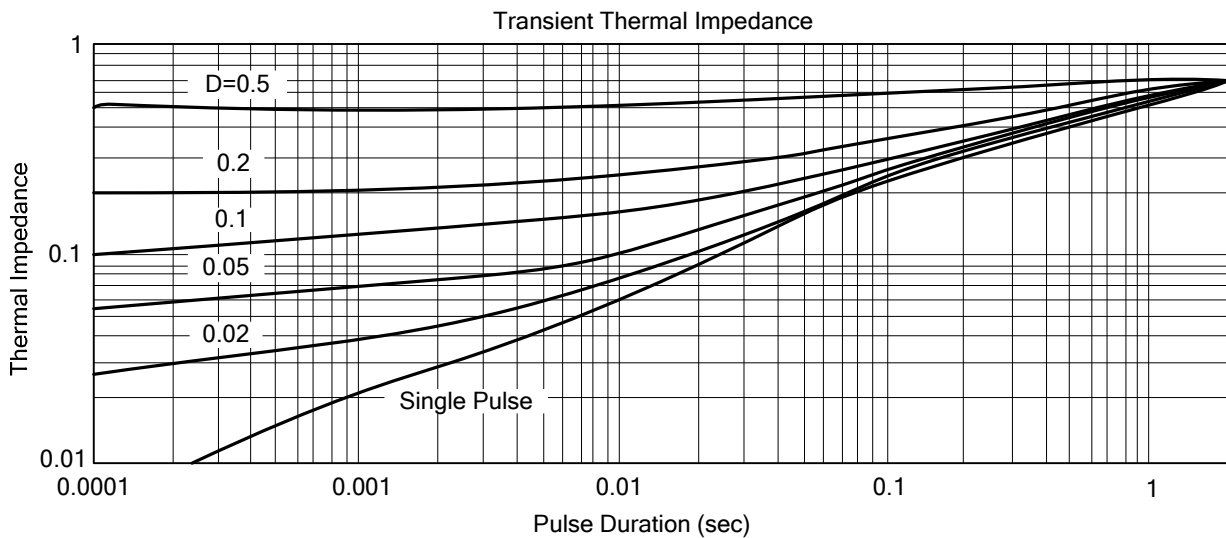
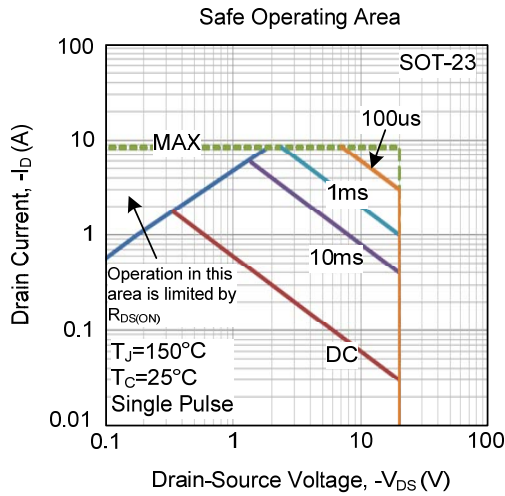

UTC assumes no responsibility for equipment failures that result from using products at values that exceed, even momentarily, rated values (such as maximum ratings, operating condition ranges, or other parameters) listed in products specifications of any and all UTC products described or contained herein. UTC products are not designed for use in life support appliances, devices or systems where malfunction of these products can be reasonably expected to result in personal injury. Reproduction in whole or in part is prohibited without the prior written consent of the copyright owner. UTC reserves the right to make changes to information published in this document, including without limitation specifications and product descriptions, at any time and without notice. This document supersedes and replaces all information supplied prior to the publication hereof.