



UT40N03

Power MOSFET

40 Amps, 30 Volts
N-CHANNEL POWER MOSFET

■ DESCRIPTION

The **UT40N03** power MOSFET provide the designer with the best combination of fast switching, ruggedized device design, low on-resistance and cost-effectiveness

■ FEATURES

- * $R_{DS(ON)} = 17m\Omega @ V_{GS} = 10 V$
- * Low capacitance
- * Optimized gate charge
- * Fast switching capability
- * Avalanche energy specified

■ SYMBOL

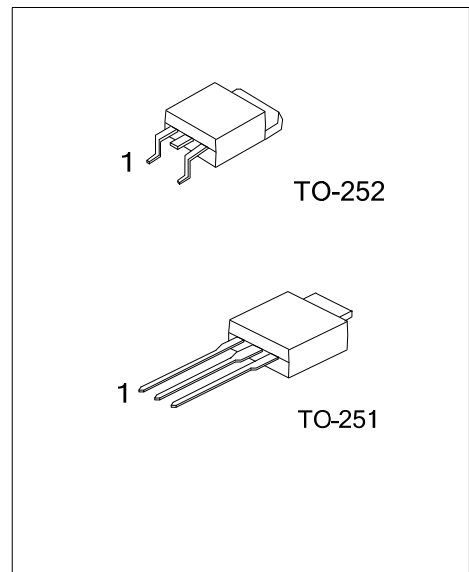
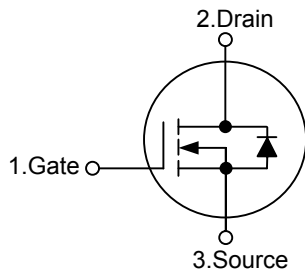

■ ORDERING INFORMATION

Ordering Number		Package	Pin Assignment			Packing
Lead Free	Halogen Free		1	2	3	
UT40N03L-TN3-R	UT40N03G-TN3-R	TO-252	G	D	S	Tape Reel
UT40N03L-TM3-T	UT40N03G-TM3-T	TO-251	G	D	S	Tube

<p>UT40N03L-TN3-R</p> <p>(1)Packing Type</p> <p>(2)Package Type</p> <p>(3)Lead Free</p>	<p>(1) R: Tape Reel, T: Tube</p> <p>(2) TN3: TO-252, TM3: TO-251</p> <p>(3) G: Halogen Free, L: Lead Free</p>
---	---

■ ABSOLUTE MAXIMUM RATINGS (T_J=25°C, unless otherwise specified)

PARAMETER	SYMBOL	RATINGS	UNIT
Drain-Source Voltage	V _{DSS}	30	V
Gate-Source Voltage	V _{GSS}	±20	V
Continuous Drain Current	I _D	40	A
Pulsed Drain Current (Note 1)	I _{DM}	169	A
Total Power Dissipation	TO-251	50	W
	TO-252	50	W
Junction Temperature	T _J	+150	°C
Storage Temperature	T _{STG}	-55 ~ +150	°C

Note: Absolute maximum ratings are those values beyond which the device could be permanently damaged.

Absolute maximum ratings are stress ratings only and functional device operation is not implied.

■ THERMAL DATA

PARAMETER	SYMBOL	RATINGS	UNIT
Junction to Ambient	TO-251	62	°C/W
	TO-252	62	°C/W
Junction to Case	TO-251	2.5	°C/W
	TO-252	2.5	°C/W

■ ELECTRICAL CHARACTERISTICS (T_A =25°C, unless otherwise specified)

PARAMETER	SYMBOL	TEST CONDITIONS	MIN	TYP	MAX	UNIT
OFF CHARACTERISTICS						
Drain-Source Breakdown Voltage	BV _{DSS}	V _{GS} =0 V, I _D =250 μA	30			V
Drain-Source Leakage Current	I _{DSS}	V _{DS} =30 V, V _{GS} =0 V, T _J =25°C			1	μA
Gate- Source Leakage Current	I _{GSS}	V _{GS} = ±20V			±100	nA
ON CHARACTERISTICS						
Gate-Threshold Voltage	V _{GS(TH)}	V _{DS} =V _{GS} , I _D =250 μA	1		3	V
Drain-Source On-State Resistance	R _{DS(ON)}	V _{GS} =10 V, I _D =20 A		14	17	mΩ
		V _{GS} =4.5 V, I _D =16 A		20	23	
DYNAMIC PARAMETERS						
Input Capacitance	C _{ISS}	V _{DS} =25 V, V _{GS} =0V, f=1.0MHz		800		pF
Output Capacitance	C _{OSS}			380		
Reverse Transfer Capacitance	C _{RSS}			133		
SWITCHING PARAMETERS						
Turn-ON Delay Time	t _{D(ON)}	V _{DS} =15 V, I _D =20 A, V _{GS} =10V, R _G =3.3 Ω, R _L =0.75 Ω		7.2		ns
Turn-ON Rise Time	t _R			60		
Turn-OFF Delay Time	t _{D(OFF)}			22.5		
Turn-OFF Fall-Time	t _F			10		
Total Gate Charge	Q _G	V _{DS} =24V, V _{GS} =5 V, I _D =20 A		17		nC
Gate-Source Charge	Q _{GS}			3		
Gate-Drain Charge	Q _{GD}			10		
SOURCE- DRAIN DIODE RATINGS AND CHARACTERISTICS						
Drain-Source Diode Forward Voltage	V _{SD}	T _J =25°C, I _S =40A, V _{GS} =0V			1.3	V
Maximum Continuous Drain-Source Diode Forward Current	I _S	V _D =V _G =0V, V _S =1.3V			40	A
Maximum Pulsed Drain-Source Diode Forward Current	I _{SM}				169	

Notes: 1. Pulse width limited by T_{J(MAX)}

2. Pulse width ≤300us, duty cycle ≤2%.

TYPICAL CHARACTERISTICS

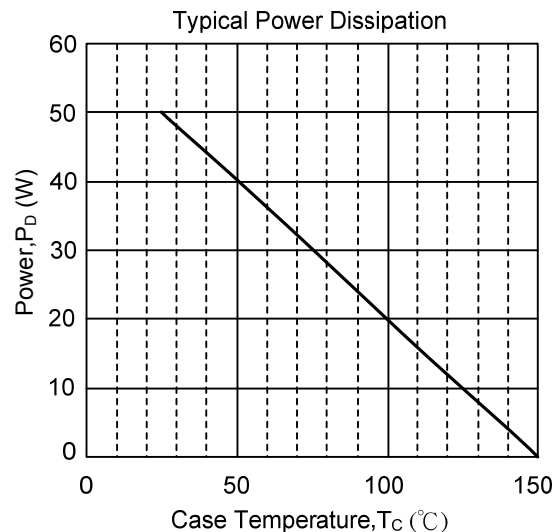
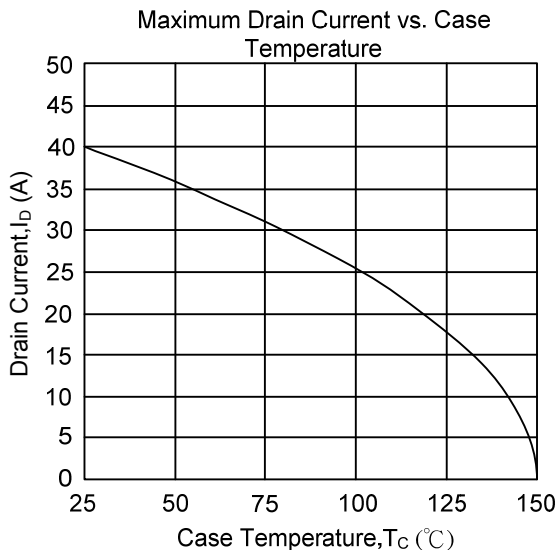
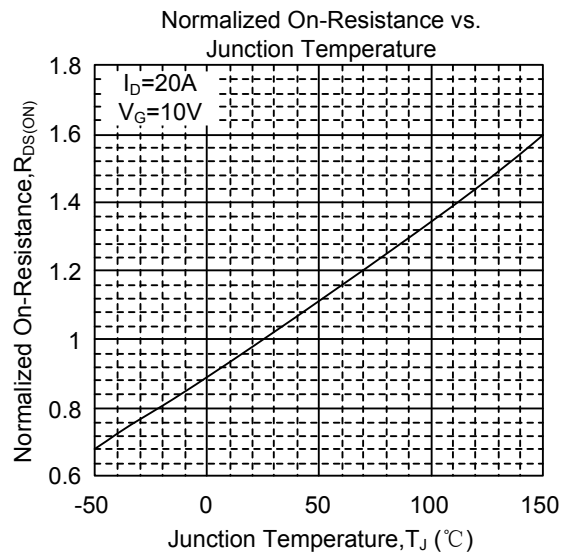
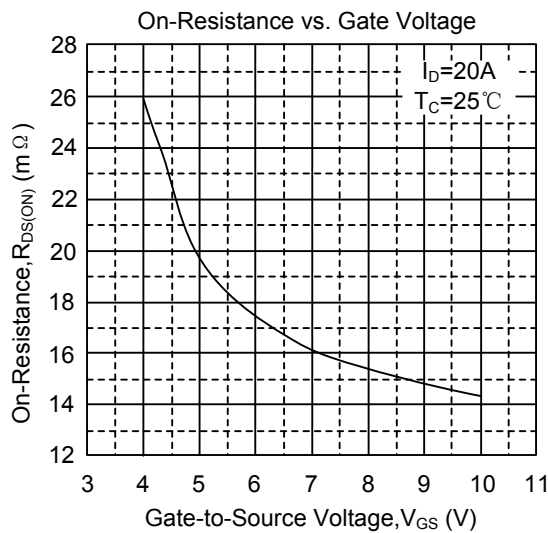
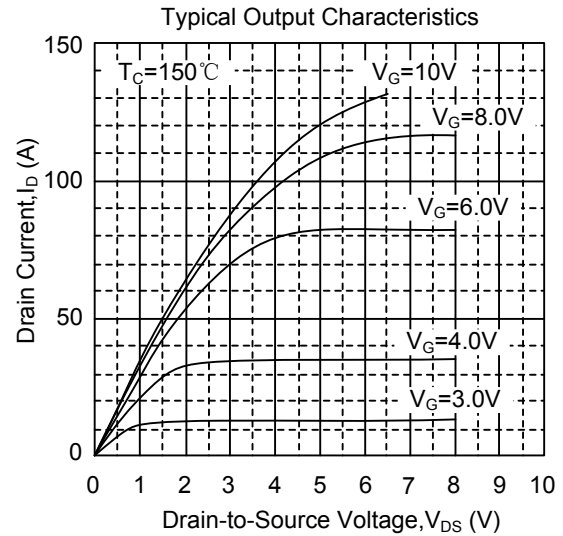
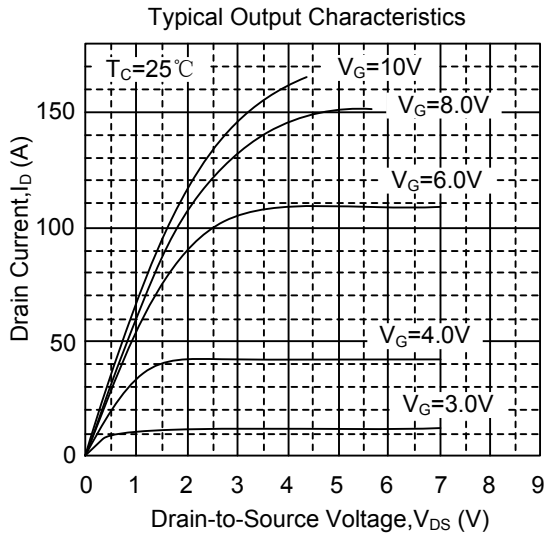

TYPICAL CHARACTERISTICS(Cont.)

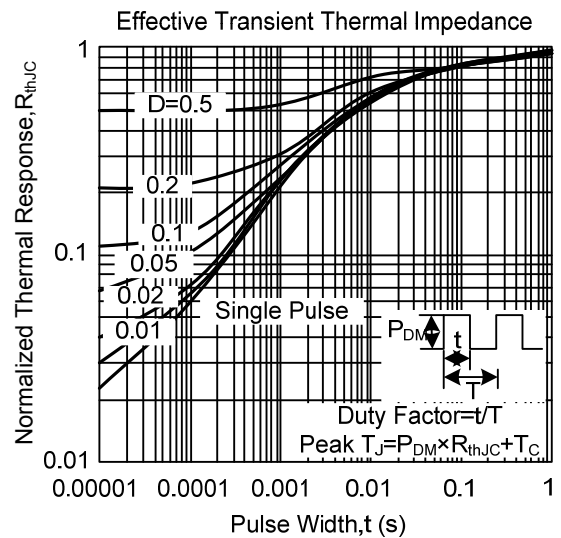
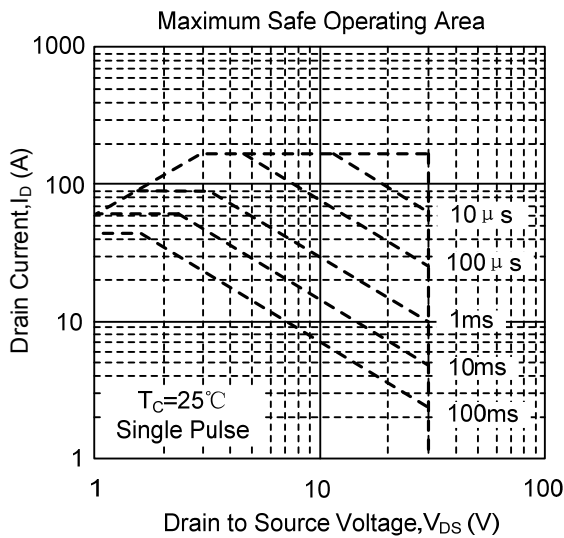
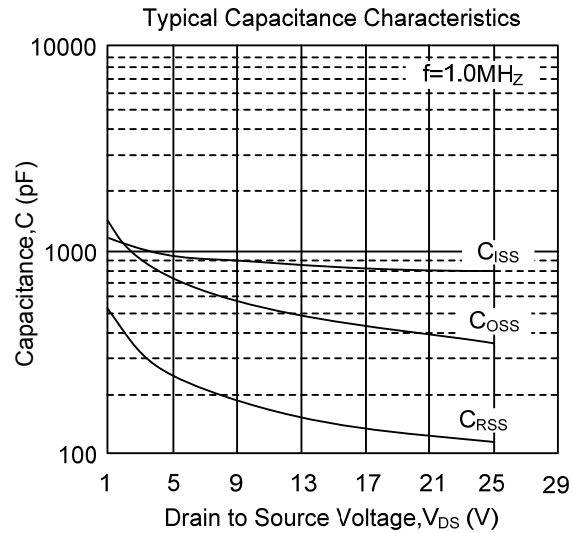
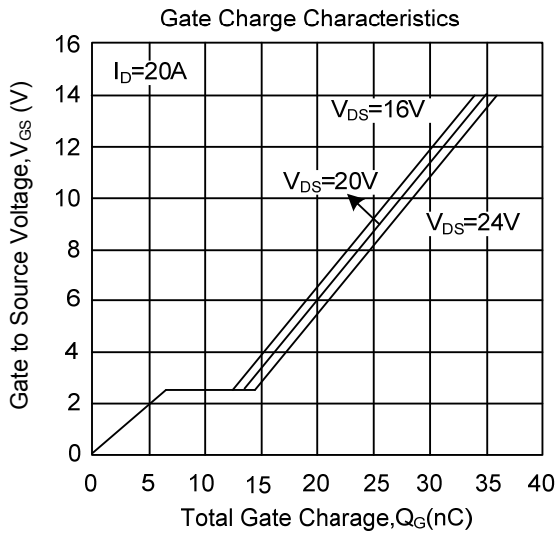
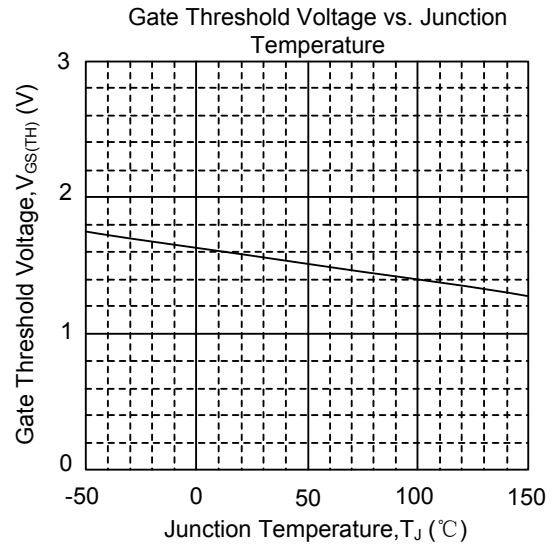
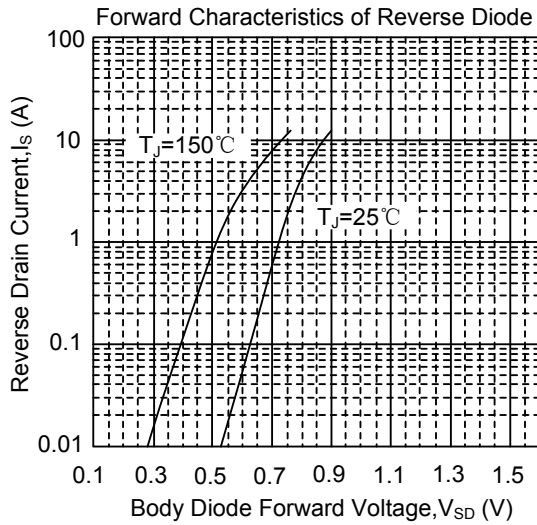

UTC assumes no responsibility for equipment failures that result from using products at values that exceed, even momentarily, rated values (such as maximum ratings, operating condition ranges, or other parameters) listed in products specifications of any and all UTC products described or contained herein. UTC products are not designed for use in life support appliances, devices or systems where malfunction of these products can be reasonably expected to result in personal injury. Reproduction in whole or in part is prohibited without the prior written consent of the copyright owner. The information presented in this document does not form part of any quotation or contract, is believed to be accurate and reliable and may be changed without notice.