



UT60N03

Power MOSFET

30V, 60A N-CHANNEL LOGIC LEVEL MOSFET

DESCRIPTION

This device employs advanced MOSFET technology and features low gate charge while maintaining low on-resistance.

Optimized for switching applications, this device improves the overall efficiency of DC/DC converters and allows operation to higher switching frequencies.

FEATURES

- * $R_{DS(ON)} < 23m\Omega @ V_{GS}=10V, I_D=30A$
- * $R_{DS(ON)} < 30m\Omega @ V_{GS}=4.5V, I_D=19A$
- * Low Capacitance
- * Low Gate Charge
- * Fast Switching Capability
- * Avalanche Energy Specified

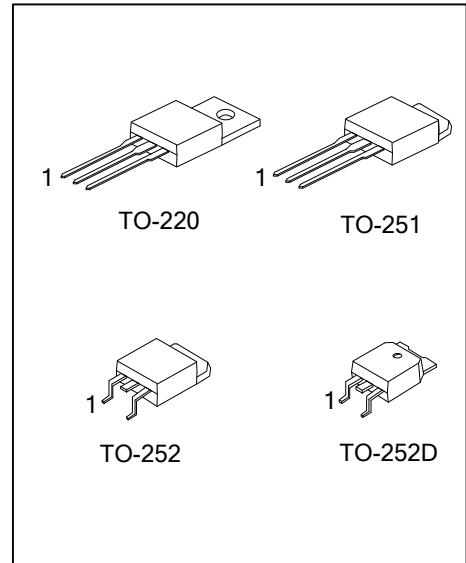

SYMBOL

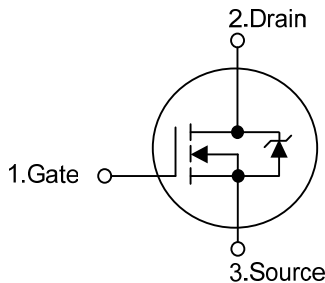

ORDERING INFORMATION

Ordering Number		Package	Pin Assignment			Packing
Lead Free	Halogen Free		1	2	3	
UT60N03L-TA3-T	UT60N03G-TA3-T	TO-220	G	D	S	Tube
UT60N03L-TM3-T	UT60N03G-TM3-T	TO-251	G	D	S	Tube
UT60N03L-TN3-R	UT60N03G-TN3-R	TO-252	G	D	S	Tape Reel
UT60N03L-TND-R	UT60N03G-TND-R	TO-252D	G	D	S	Tape Reel

Note: Pin Assignment: G: Gate D: Drain S: Source

<p>UT60N03L-TA3-R</p> <ul style="list-style-type: none"> (1) Packing Type (2) Package Type (3) Green Package 	<ul style="list-style-type: none"> (1) R: Tape Reel, T: Tube (2) TA3: TO-220, TM3: TO-251, TN3: TO-252 (3) L: Lead Free, G: Halogen Free and Lead Free
---	---

■ MARKING

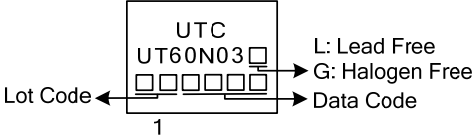

■ ABSOLUTE MAXIMUM RATINGS (T_c=25°C, unless otherwise specified)

PARAMETER		SYMBOL	RATINGS	UNIT
Drain-Source Voltage		V _{DSS}	30	V
Gate-Source Voltage		V _{GSS}	±20	V
Continuous Drain Current (V _{GS} =10V)		I _D	60	A
Power Dissipation	TO-220	P _D	60	W
	TO-251/TO-252		45	
Derate above 25°C	TO-220		0.4	W/°C
	TO-251/TO-252		0.37	
Junction Temperature		T _J	+150	°C
Storage Temperature		T _{STG}	-55 ~ +150	°C

Note: Absolute maximum ratings are those values beyond which the device could be permanently damaged. Absolute maximum ratings are stress ratings only and functional device operation is not implied.

■ THERMAL RESISTANCES CHARACTERISTICS

PARAMETER		SYMBOL	RATINGS	UNIT
Junction to Ambient	TO-220	θ _{JA}	62.5	°C/W
	TO-251/TO-252		100	
Junction to Case	TO-220	θ _{JC}	2.5	°C/W
	TO-251/TO-252		2.73	

■ ELECTRICAL CHARACTERISTICS (T_c=25°C, unless otherwise specified)

PARAMETER	SYMBOL	TEST CONDITIONS	MIN	TYP	MAX	UNIT
OFF CHARACTERISTICS						
Drain-Source Breakdown Voltage	BV _{DSS}	V _{GS} =0V, I _D =250μA	30			V
Drain-Source Leakage Current	I _{DSS}	V _{DS} =25V, V _{GS} =0V			1	μA
Gate-Source Leakage Current	I _{GSS}	V _{DS} =0V, V _{GS} =±20V			±100	nA
ON CHARACTERISTICS						
Gate Threshold Voltage	V _{GS(TH)}	V _{DS} =V _{GS} , I _D =250μA	1		3	V
Static Drain-Source On-Resistance	R _{DS(ON)}	V _{GS} =10V, I _D =30A		14	23	mΩ
		V _{GS} =4.5V, I _D =19A		24	30	
DYNAMIC PARAMETERS						
Input Capacitance	C _{ISS}	V _{DS} =15V, V _{GS} =0V, f=1MHz		900		pF
Output Capacitance	C _{OSS}			210		pF
Reverse Transfer Capacitance	C _{RSS}			90		pF
SWITCHING PARAMETERS						
Turn-ON Time	t _(ON)	V _{DD} =15V, I _D =7.9A, R _L =18Ω, V _{GS} =4.5V			90	ns
Turn-ON Delay Time	t _{D(ON)}			11		ns
Turn-ON Rise Time	t _R			49		ns
Turn-OFF Time	t _(OFF)				83	ns
Turn-OFF Delay Time	t _{D(OFF)}			27		ns
Turn-OFF Fall-Time	t _F			28		ns
Turn-ON Time	t _(ON)	V _{DD} =15V, I _D =7.9A, R _L =18Ω, V _{GS} =10V			48	ns
Turn-ON Delay Time	t _{D(ON)}			6		ns
Turn-ON Rise Time	t _R			26		ns
Turn-OFF Time	t _(OFF)				120	ns
Turn-OFF Delay Time	t _{D(OFF)}			52		ns
Turn-OFF Fall-Time	t _F			28		ns
Total Gate Charge	5V	Q _G	V _{GS} =0V~5V, V _{DD} =15V, I _D =19A, I _G =1.0mA	18	28	nC
	10V		V _{GS} =0V~10V, V _{DD} =15V, I _D =19A, I _G =1.0mA	9.6	14	
Threshold Gate Charge	Q _{G(TH)}	V _{GS} =0V~1V, V _{DD} =15V, I _D =19A, I _G =1.0mA	1.0	1.5		nC
Gate-Source Charge	Q _{GS}	V _{DD} =15V, I _D =19A, I _G =1.0mA		3.4		nC
Gate-Drain Charge	Q _{GD}			3.4		nC
SOURCE- DRAIN DIODE RATINGS AND CHARACTERISTICS						
Drain-Source Diode Forward Voltage	V _{SD}	I _{SD} =19A			1.25	V
		I _{SD} =10A			1.0	
Reverse Recovery Time	t _{rr}	I _{SD} =9A, di _s /dt =100A/s,			58	ns
Reverse Recovery Charge	Q _{RR}				70	nC

TYPICAL CHARACTERISTICS

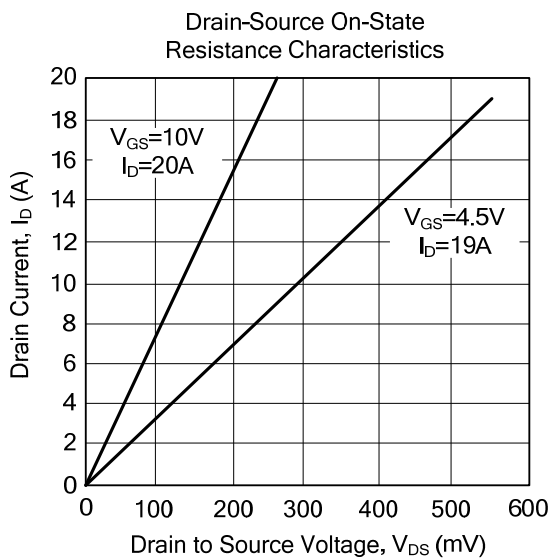
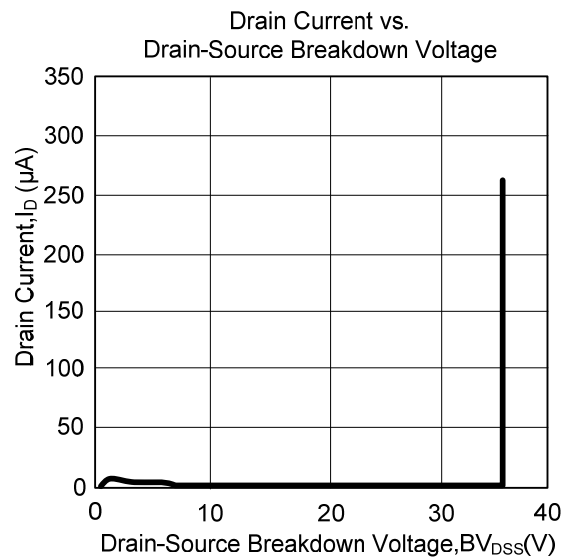
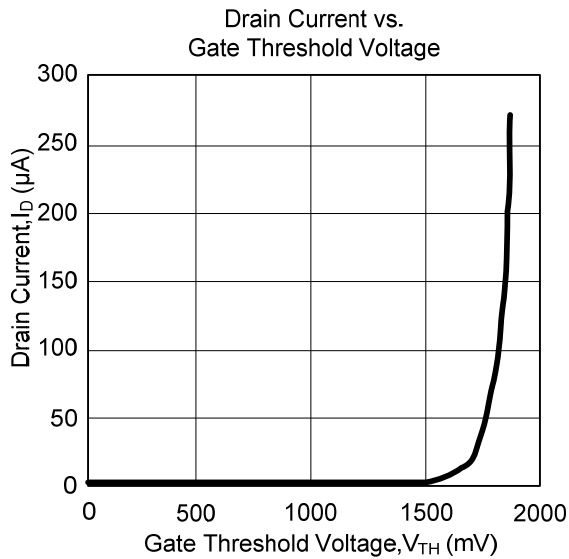
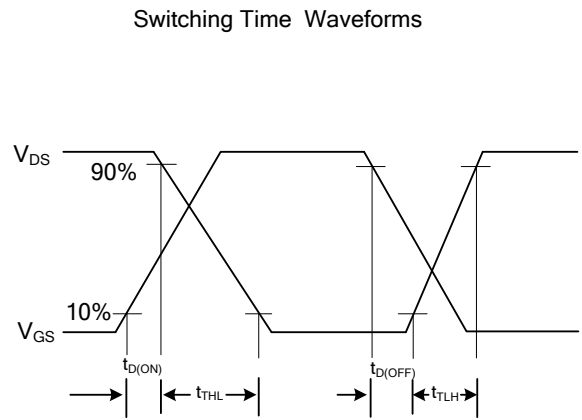
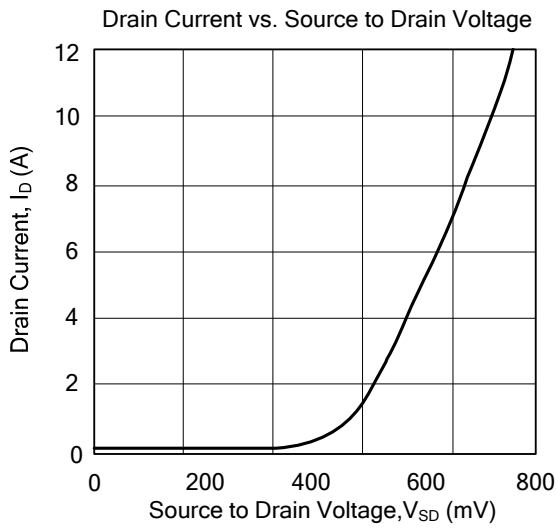

UTC assumes no responsibility for equipment failures that result from using products at values that exceed, even momentarily, rated values (such as maximum ratings, operating condition ranges, or other parameters) listed in products specifications of any and all UTC products described or contained herein. UTC products are not designed for use in life support appliances, devices or systems where malfunction of these products can be reasonably expected to result in personal injury. Reproduction in whole or in part is prohibited without the prior written consent of the copyright owner. The information presented in this document does not form part of any quotation or contract, is believed to be accurate and reliable and may be changed without notice.