



UT70P02

Power MOSFET

P-CHANNEL ENHANCEMENT MODE POWER MOSFET

DESCRIPTION

The **UT70P02** uses advanced trench technology to provide excellent $R_{DS(ON)}$, low gate charge and operation with low gate voltages. This device is suitable for use as a load switch or in PWM applications.

FEATURES

- * $R_{DS(ON)} = 6m\Omega @V_{GS} = -10V$
- * Low capacitance
- * Low gate charge
- * Fast switching capability
- * Avalanche energy specified

SYMBOL

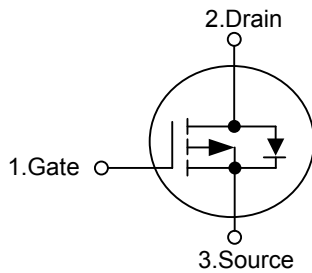

ORDERING INFORMATION

Ordering Number		Package	Pin Assignment			Packing
Normal	Lead Free Plating		1	2	3	
UT70P02-TN3-R	UT70P02L-TN3-R	TO-252	G	D	S	Tape Reel
UT70P02-TN3-T	UT70P02L-TN3-T	TO-252	G	D	S	Tube

<p>UT70P02L-TN3-R</p> <p>(1)Packing Type</p> <p>(2)Package Type</p> <p>(3)Lead Plating</p>	<p>(1) R: Tape Reel, T: Tube</p> <p>(2) TN3: TO-252</p> <p>(3) L: Lead Free Plating, Blank: Pb/Sn</p>
--	---

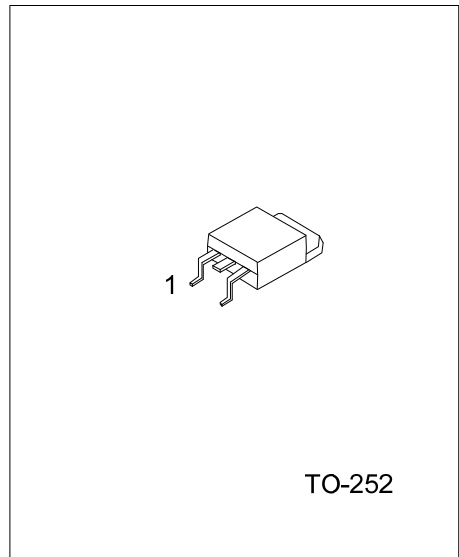

*Pb-free plating product number: UT70P02L

■ ABSOLUTE MAXIMUM RATINGS ($T_A=25^\circ\text{C}$ unless otherwise specified)

PARAMETER	SYMBOL	RATINGS	UNIT
Drain-Source Voltage	V_{DSS}	-25	V
Gate-Source Voltage	V_{GSS}	± 20	V
Continuous Drain Current, $V_{GS}=4.5\text{V}$	I_D	-75	A
Pulsed Drain Current (Note 1)	I_{DM}	-350	A
Power Dissipation @ $T_C=25^\circ\text{C}$	P_D	107	W
Junction Temperature	T_J	+175	$W/^\circ\text{C}$
Strong Temperature	T_{STG}	-55 ~ +175	$^\circ\text{C}$

Note: Absolute maximum ratings are those values beyond which the device could be permanently damaged.
Absolute maximum ratings are stress ratings only and functional device operation is not implied.

■ THERMAL DATA

PARAMETER	SYMBOL	MIN	TYP	MAX	UNIT
Junction-to-Ambient	θ_{JA}			110	$^\circ\text{C}/\text{W}$
Junction-to-Case	θ_{JC}			1.4	$^\circ\text{C}/\text{W}$

■ ELECTRICAL CHARACTERISTICS ($T_J=25^\circ\text{C}$, unless otherwise noted)

PARAMETER	SYMBOL	TEST CONDITIONS	MIN	TYP	MAX	UNIT
OFF CHARACTERISTICS						
Drain-Source Breakdown Voltage	BV_{DSS}	$V_{GS}=0\text{V}, I_D=-250\mu\text{A}$	-25			V
Breakdown Voltage Temperature Coefficient	$\Delta BV_{DSS}/\Delta T_J$	Reference to $25^\circ\text{C}, I_D=-1\text{mA}$		-0.018		$V/^\circ\text{C}$
Drain-Source Leakage Current	I_{DSS}	$V_{DS}=-30\text{V}, V_{GS}=0\text{V}, T_J=25^\circ\text{C}$			-1	μA
Gate-Body Leakage Current	I_{GSS}	$V_{GS}=\pm 20\text{V}$			± 100	nA
ON CHARACTERISTICS						
Gate Threshold Voltage	$V_{GS(TH)}$	$V_{DS}=V_{GS}, I_D=-250\mu\text{A}$	-1		-3	V
Static Drain-Source On-Resistance (Note 2)	$R_{DS(ON)}$	$V_{GS}=-10\text{V}, I_D=-10\text{A}$ $V_{GS}=-4.5\text{V}, I_D=-10\text{A}$			7 10	m Ω
DYNAMIC PARAMETERS						
Input Capacitance	C_{ISS}	$V_{DS}=-25\text{V}, V_{GS}=0\text{V}, f=1.0\text{MHz}$		2700	4200	pF
Output Capacitance	C_{OSS}			550		pF
Reverse Transfer Capacitance	C_{RSS}			380		pF
SWITCHING PARAMETERS						
Total Gate Charge(Note 2)	Q_G	$V_{DS}=-24\text{V}, V_{GS}=-4.5\text{V}, I_D=-30\text{A}$		33	52	nC
Gate Source Charge	Q_{GS}			7.5		nC
Gate Drain ("Miller") Charge	Q_{GD}			24		nC
Turn-ON Delay Time(Note 2)	$t_{D(ON)}$	$V_{GS}=-10\text{V}, V_{DS}=-15\text{V}, R_D=0.5\Omega, I_D=-30\text{A}, R_G=3.3\Omega$		11.2		ns
Turn-ON Rise Time	t_R			77		ns
Turn-OFF Delay Time	$t_{D(OFF)}$			35		ns
Turn-OFF Fall-Time	t_F			67		ns
SOURCE- DRAIN DIODE RATINGS AND CHARACTERISTICS						
Forward On Voltage(Note 2)	V_{SD}	$I_S=-10\text{A}, V_{GS}=0\text{V}$			-1.3	V
Reverse Recovery Time	t_{RR}	$I_S=-30\text{A}, V_{GS}=0\text{V}$		28		ns
Reverse Recovery Charge	Q_{RR}	$di/dt=100\text{A}/\mu\text{s}$		10		nC

Notes: 1.Pulse width limited by safe operating area.
2.Pulse width $\leq 300\mu\text{s}$, duty cycle $\leq 2\%$.

TYPICAL CHARACTERISTICS

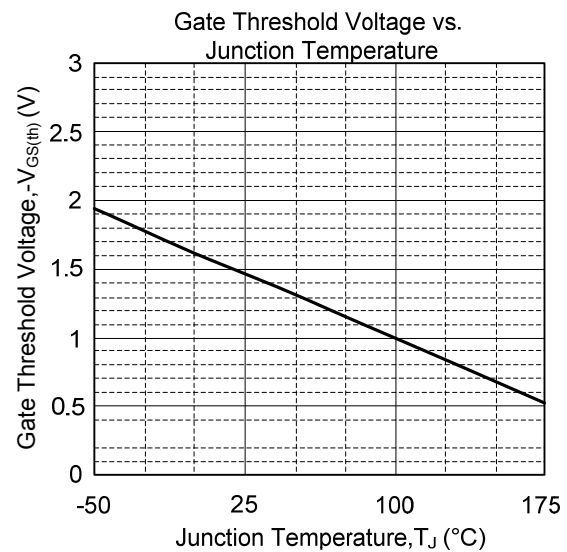
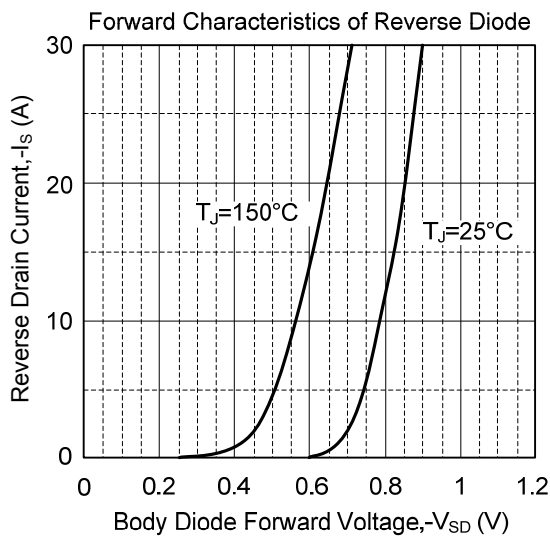
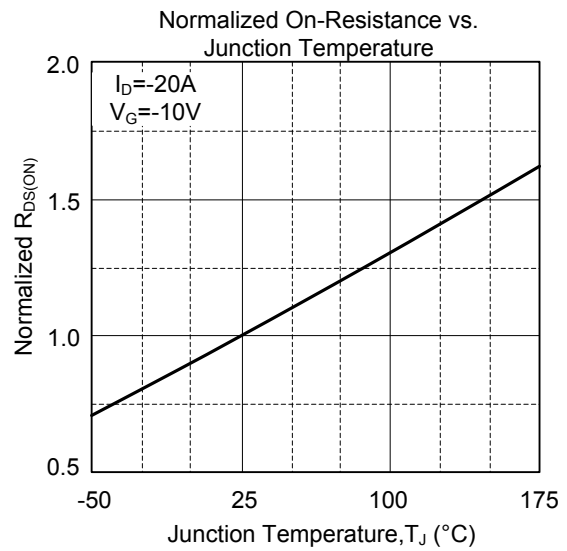
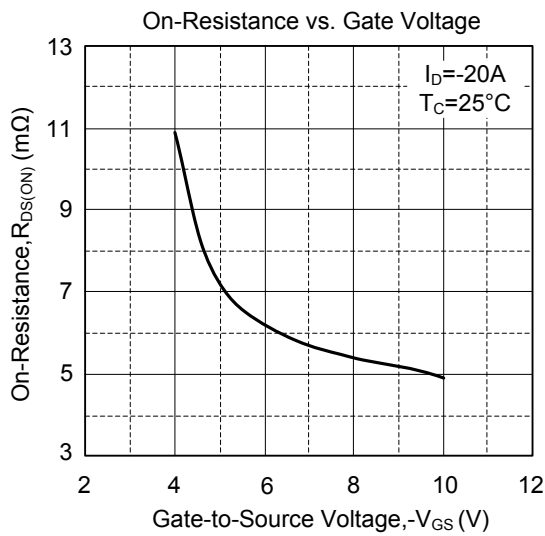
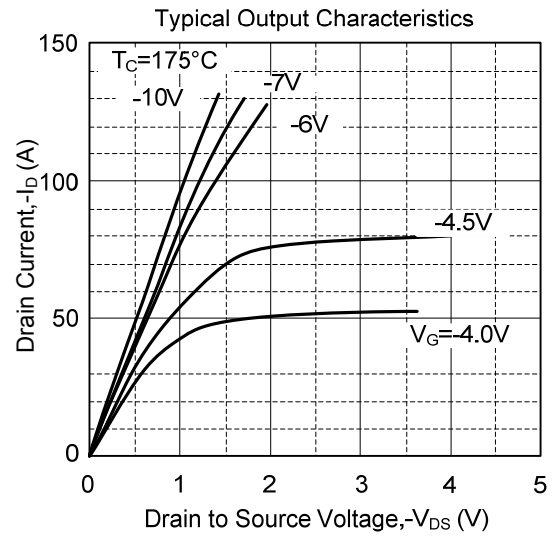
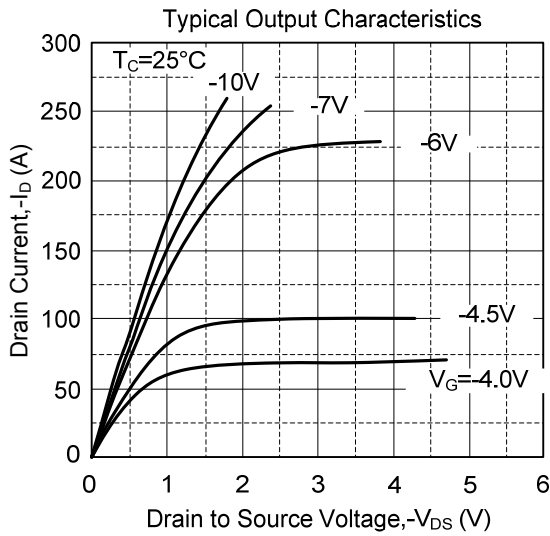

TYPICAL CHARACTERISTICS(Cont.)

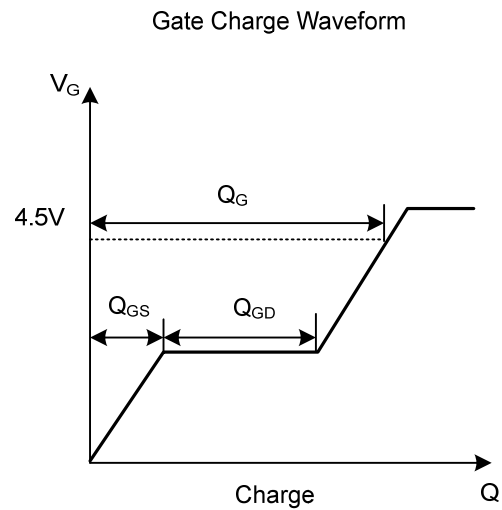
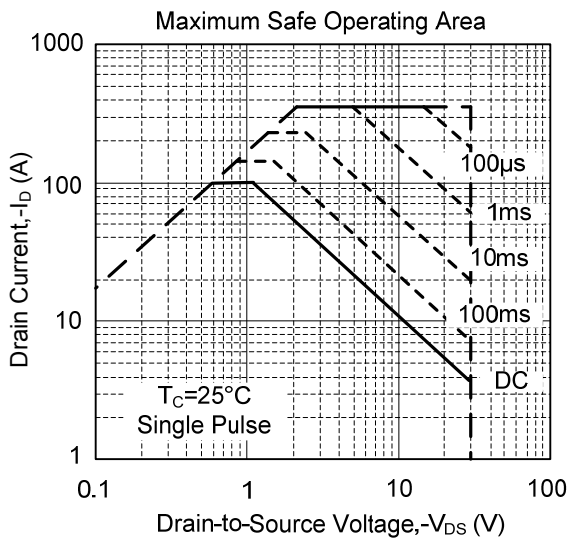
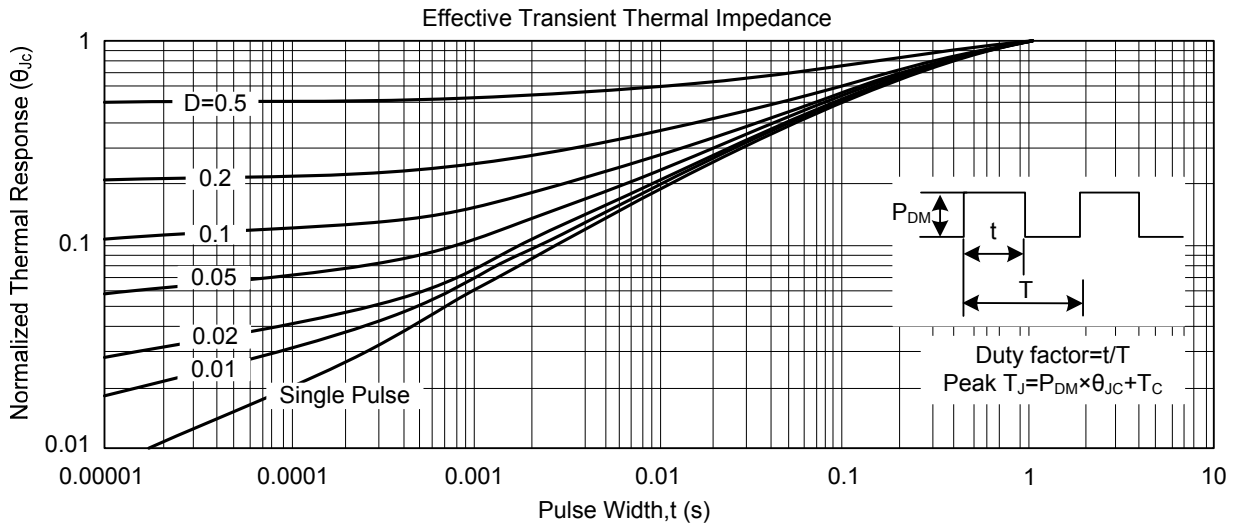
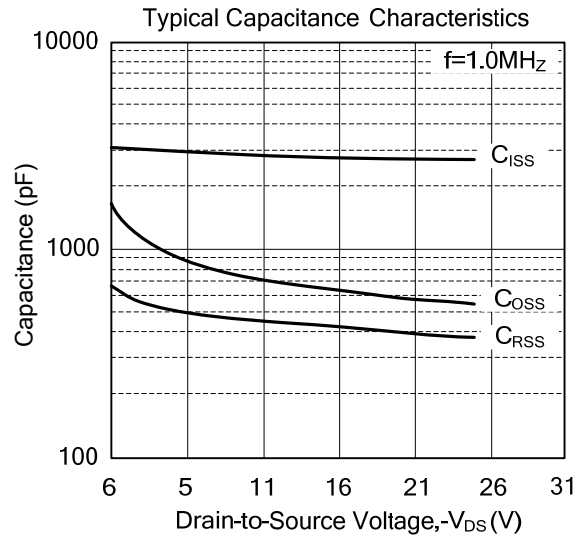
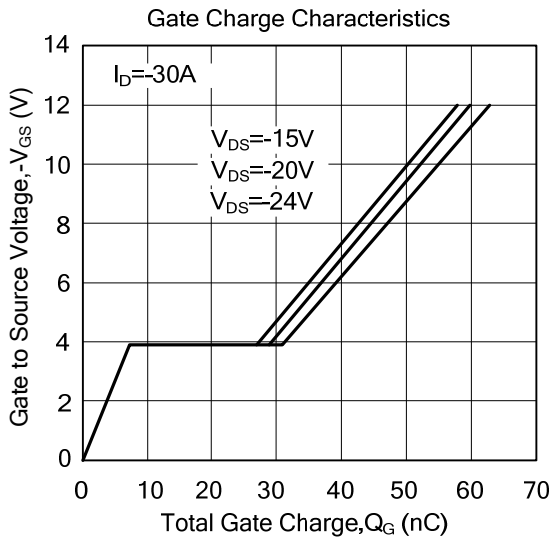

UTC assumes no responsibility for equipment failures that result from using products at values that exceed, even momentarily, rated values (such as maximum ratings, operating condition ranges, or other parameters) listed in products specifications of any and all UTC products described or contained herein. UTC products are not designed for use in life support appliances, devices or systems where malfunction of these products can be reasonably expected to result in personal injury. Reproduction in whole or in part is prohibited without the prior written consent of the copyright owner. The information presented in this document does not form part of any quotation or contract, is believed to be accurate and reliable and may be changed without notice.