



# Thin-Film Cascadable Amplifier 500 to 2000 MHz

## Technical Data

### UTO/UTC 2012 Series

#### Features

- **Frequency Range: 500 to 2000 MHz**
- **High Dynamic Range**
- **Noise Figure: 3.0 dB (Typ)**
- **GaAs FET Technology**
- **Temperature Compensated**
- **Surface Mount Option**

#### Applications

- **System Front End**
- **Surface Mount Assembly**

#### Description

The 2012 Series is a thin-film GaAs FET RF amplifier using active bias and resistive feedback for stability over temperature and bias voltage variations. Input/output blocking capacitors couple RF through the amplifier while a low VSWR is maintained through inductive tuning. The 2012 Series amplifiers are available in three packages: the surface mount PlanarPak PP-38 (.375 in. x .375 in.) case, the TO-8 hermetic case and the connectorized TC-1 case.

#### Pin Configuration

##### UTO—TO-8U

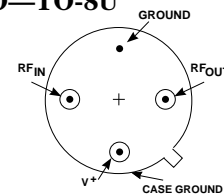

##### UTC—TC-1

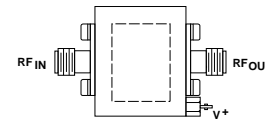

#### Schematic

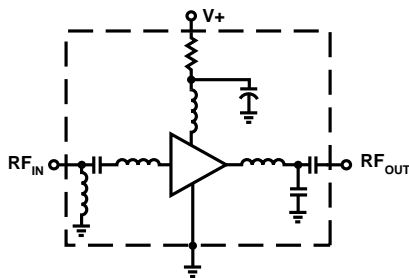

#### Maximum Ratings

Parameter	Maximum
DC Voltage	+17 Volts
Continuous RF Input Power	+15 dBm
Operating Case Temperature	-55 to +125°C
Storage Temperature	-62 to +150°C
"R" Series Burn-In Temperature	+125°C

#### Thermal Characteristics<sup>1</sup>

$\theta_{JC}$	100°C/W
Active Transistor Power Dissipation	250 mW
Junction Temperature Above Case Temperature	25°C
MTBF (MIL-HDBK-217E, $A_{UF}$ @ 90°C)	299,200 Hrs.

**Weight:** (typical) PPA—0.5 grams; UTO—2.1 grams; UTC—21.5 grams

## Electrical Specifications<sup>1</sup>

(Measured in 50  $\Omega$  system @ +15 VDC nominal unless otherwise noted)

Symbol	Characteristic	Typical $T_C = 25^\circ\text{C}$	Guaranteed Specifications		Unit
			$T_C = 0 \text{ to } 50^\circ\text{C}$	$T_C = -55 \text{ to } +85^\circ\text{C}$	
BW	Frequency Range	500-2000	500-2000	500-2000	MHz
GP	Small Signal Gain (Min.)	11.0	9.0	8.5	dB
—	Gain Flatness (Max.)	$\pm 0.5$	$\pm 1.0$	$\pm 1.0$	dB
NF	Noise Figure (Max.)	3.0	4.0	4.5	dB
$P_{1dB}$	Power Output @ +1 dB Comp. (Min.)	+14.0	+12.0	+11.0	dBm
—	Input VSWR (Max.)	<1.6:1	2.0:1	2.0:1	—
—	Output VSWR (Max.)	<1.6:1	2.0:1	2.0:1	—
$IP_3$	Two Tone 3rd Order Intercept Point	+23.0	—	—	dBm
$IP_2$	Two Tone 2nd Order Intercept Point	+33.0	—	—	dBm
$HP_2$	One Tone 2nd Order Intercept Point	+39.0	—	—	dBm
$I_D$	DC Current	50	—	—	mA

Note 1: RF input pin is at DC ground—no input blocking capacitor.

## Typical Performance Over Temperature (@ +15 VDC unless otherwise noted)

Key: +25°C —  
+85°C - -  
-55°C = =

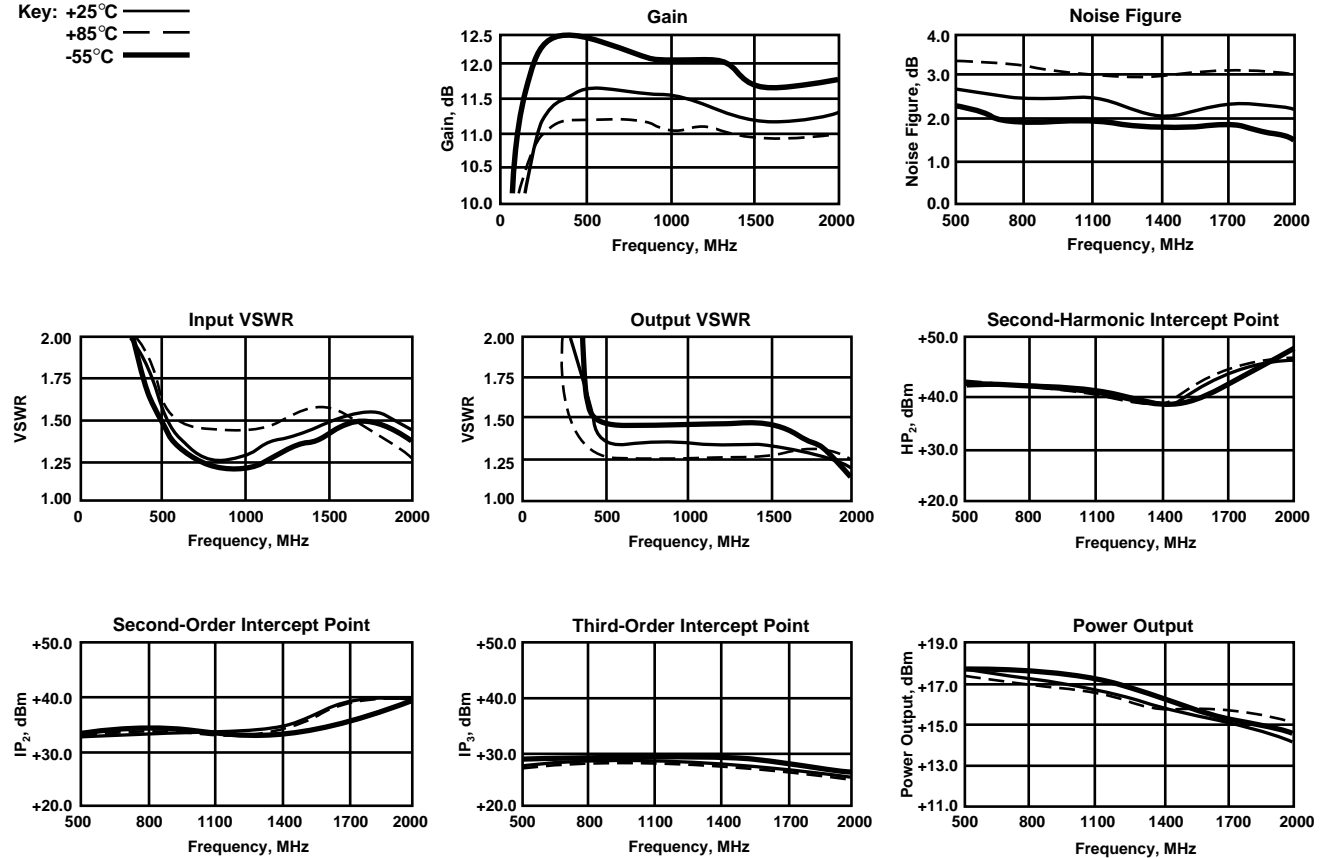

**Automatic Network Analyzer Measurements** (Typical production unit @ +25°C ambient)

**Numerical Readings**
**Bias = 15.00 Volts**

FREQUENCY MHz	VSWR IN	GAIN dB	PHASE DEGREES	PHASE DEV	GROUP DELAY ns	VSWR OUT	ISOLATION dB
500.0	1.32	10.66	170.30	9.46	.57	1.41	16.35
600.0	1.20	10.65	151.64	3.72	.49	1.45	16.60
700.0	1.11	10.59	134.99	-.02	.44	1.51	16.84
800.0	1.03	10.59	119.69	-2.41	.40	1.56	17.02
900.0	1.03	10.57	105.49	-3.71	.39	1.61	17.15
1000.0	1.06	10.67	92.93	-3.37	.33	1.62	17.34
1100.0	1.05	10.57	81.00	-2.40	.34	1.55	17.48
1200.0	1.05	10.54	68.30	-2.21	.34	1.46	17.57
1300.0	1.05	10.51	56.10	-1.51	.34	1.36	17.48
1400.0	1.06	10.49	43.58	-1.13	.34	1.30	17.46
1500.0	1.06	10.48	31.45	-.37	.35	1.30	17.44
1600.0	1.04	10.57	18.63	-.28	.33	1.35	17.35
1700.0	1.05	10.55	7.26	1.24	.33	1.44	17.36
1800.0	1.10	10.44	-5.17	1.71	.33	1.50	17.35
1900.0	1.15	10.44	-17.67	2.12	.36	1.47	17.40
2000.0	1.19	10.35	-30.49	2.19	.36	1.36	17.37

Linearization Range: 500.0 to 2000.0 MHz

**S-Parameters**
**Bias = 15.00 Volts**

FREQUENCY MHz	S <sub>11</sub>		S <sub>21</sub>		S <sub>12</sub>		S <sub>22</sub>	
	Mag	Ang	dB	Ang	dB	Ang	Mag	Ang
500.00	.077	-21.4	10.225	172.3	-16.048	-27.4	.145	-129.7
600.00	.047	-6.7	10.208	152.5	-16.347	-39.1	.167	-155.5
700.00	.021	-17.1	10.256	136.3	-16.996	-51.0	.175	-179.4
800.00	.005	-162.4	10.250	120.6	-17.395	-62.1	.181	164.4
900.00	.028	-146.3	10.342	105.9	-17.191	-74.7	.202	148.8
1000.00	.016	128.8	10.366	93.5	-17.447	-86.4	.213	136.1
1100.00	.013	29.1	10.281	80.8	-18.202	-98.1	.189	130.2
1200.00	.030	-15.7	10.203	67.6	-17.753	-110.3	.172	118.9
1300.00	.056	-31.8	10.218	54.3	-17.535	-120.5	.133	112.4
1400.00	.046	-50.1	10.320	41.3	-17.343	-132.6	.098	98.8
1500.00	.034	-75.0	10.310	28.1	-17.653	-143.1	.079	68.0
1600.00	.020	75.8	10.573	15.8	-17.464	-158.5	.088	36.1
1700.00	.066	63.7	10.470	2.5	-17.371	-169.5	.119	10.7
1800.00	.111	80.6	10.448	-11.6	-17.828	176.7	.102	11.4
1900.00	.136	78.5	10.362	-26.9	-18.291	163.0	.202	29.2
2000.00	.103	81.1	10.227	-40.9	-17.434	149.7	.233	62.2

## Product Options

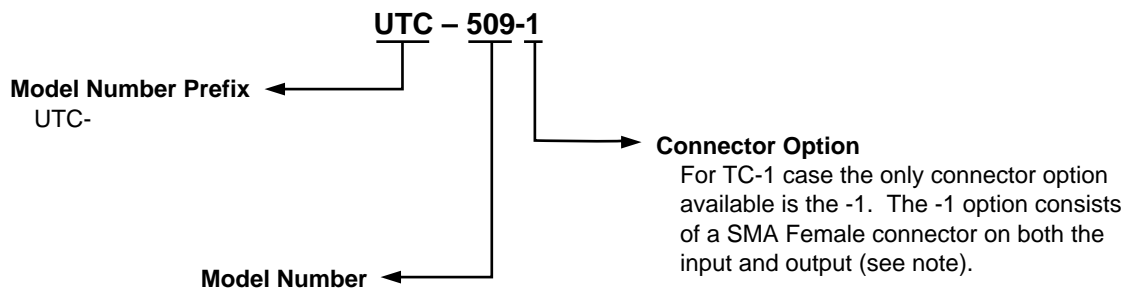
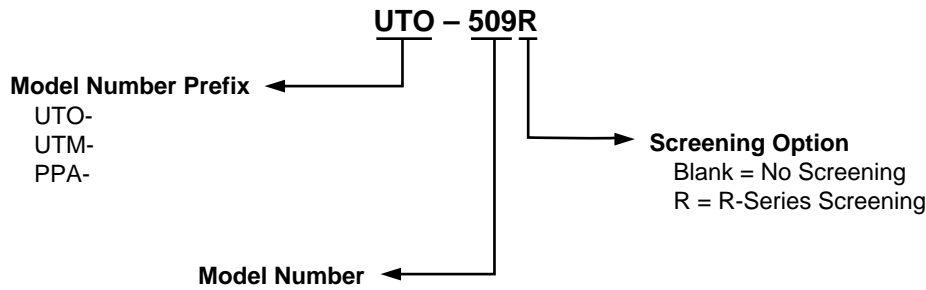

Note: R-Series screening is not available in the TC-1 case as the case is non-hermetic.

## Case Drawings TO-8U

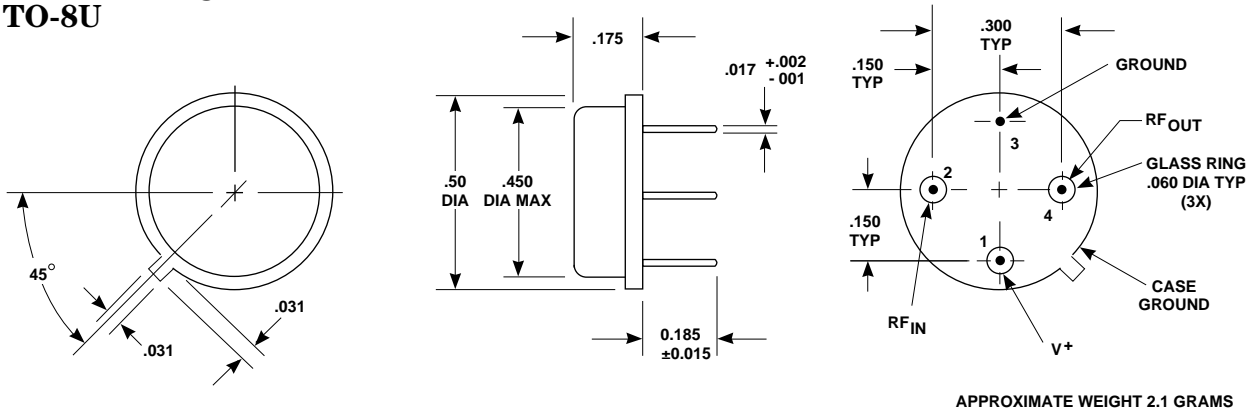

- NOTES (UNLESS OTHERWISE SPECIFIED):
1. DIMENSIONS ARE SPECIFIED IN INCHES
  2. TOLERANCES: xx ± .02  
xxx ± .010

# Case Drawings TC-1

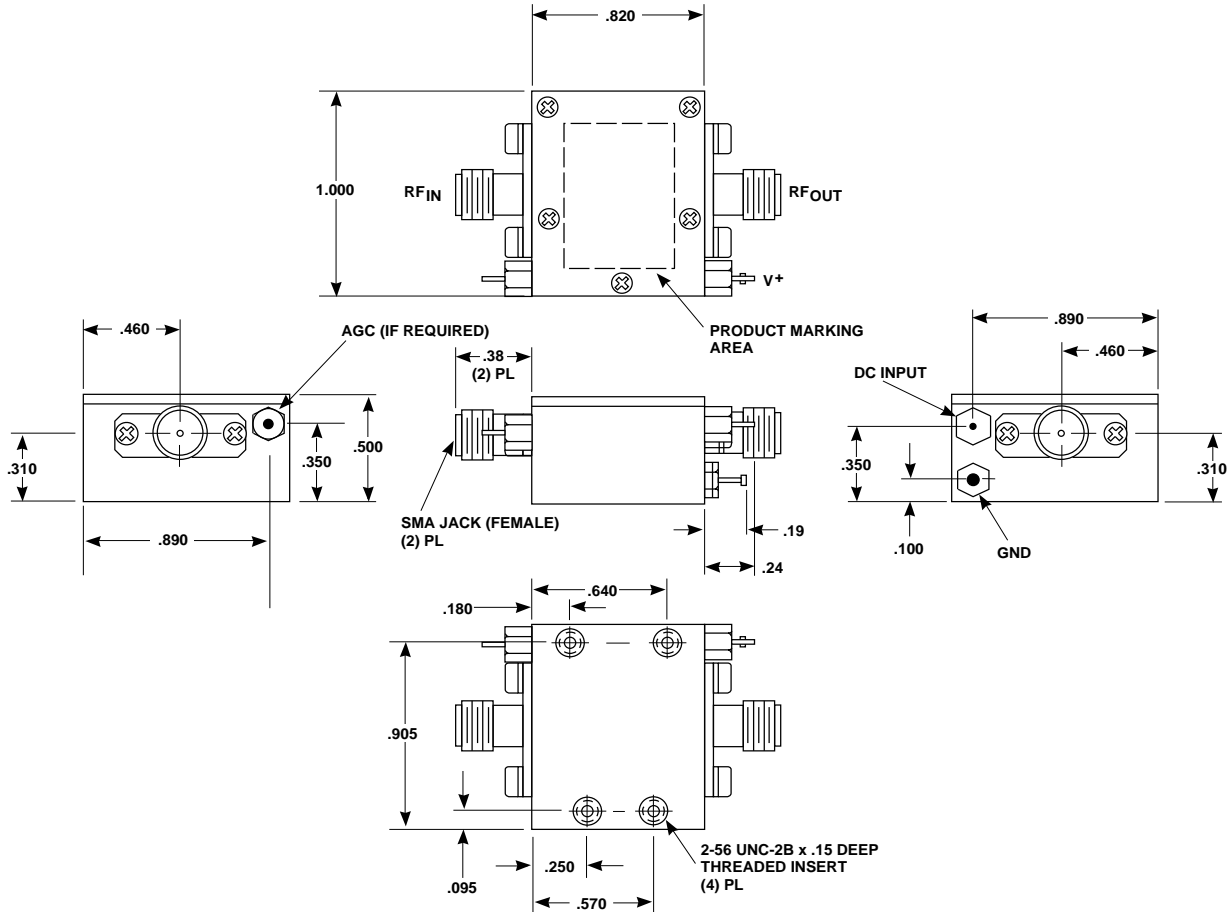

TYPICAL WEIGHT WITH CONNECTORS = 21.5 GRAMS

- NOTES: 1. THE TC-1 CASE IS A NON-HERMETIC CASE.  
2. THE ONLY CONNECTOR OPTION AVAILABLE FOR THE TC-1 CASE IS THE -1, SMA FEMALE CONNECTORS AT BOTH INPUT AND OUTPUT PORTS.

- NOTES (UNLESS OTHERWISE SPECIFIED):  
1. DIMENSIONS ARE SPECIFIED IN INCHES  
2. TOLERANCES: xx ± .02  
xxx ± .010

Contact Teledyne Cougar:  
408-522-3838  
408-522-3839 fax  
cougaramps@cougarcorp.com

Check for updates:  
www.teledyne-cougar.com