



Thin-Film Cascadable Amplifier 5 to 1000 MHz

Technical Data

UTO/UTC 1005 Series

Features

- **Frequency Range: 5 to 1000 MHz**
- **High Dynamic Range**
- **High Output Power: +21.0 dBm (Typ)**
- **Noise Figure: 5.0 dB (Typ)**
- **Temperature Compensated**
- **Surface Mount Option**

Applications

- **IF/RF Amplification**
- **Output Stage**
- **Surface Mount Assembly**

Description

The 1005 Series is a medium-gain, thinfilm bipolar RF amplifier using resistive feedback and active bias for stability over temperature and bias variations. Inductive networks maintain good VSWR while the RF is coupled through input and output blocking capacitors. The 1005 Series amplifiers are available in three packages: the surface mount hermetic PP-38 (.375 in. x .375 in.) case, the TO-8 hermetic case and the connectorized TC-1A case.

Pin Configuration

UTO—TO-8T

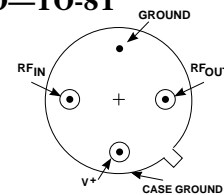

UTC—TC-1A

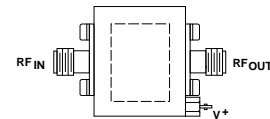

Schematic

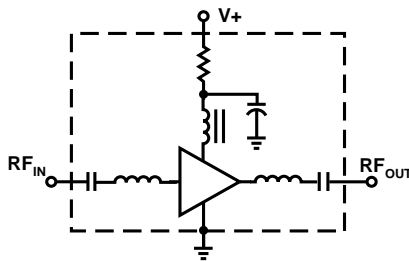

Maximum Ratings

Parameter	Maximum
DC Voltage	+17 Volts
Continuous RF Input Power	+15 dBm
Operating Case Temperature	-55 to +115°C
Storage Temperature	-62 to +150°C
"R" Series Burn-In Temperature	+115°C

Thermal Characteristics¹

θ_{JC}	75°C/W
Active Transistor Power Dissipation	413 mW
Junction Temperature Above Case Temperature	31°C
MTBF (MIL-HDBK-217E, A_{UF} @ 90°C)	498,452 Hrs.

Weight: (typical) UTO—2.1 grams; UTC—21.5 grams
www.DataSheet4U.com

Electrical Specifications

(Measured in 50 Ω system @ +15 VDC nominal unless otherwise noted)

Symbol	Characteristic	Typical T _C = 25°C	Guaranteed Specifications		Unit
			T _C = 0 to 50°C	T _C = -55 to +85°C	
BW	Frequency Range	5-1000	5-1000	5-1000	MHz
GP	Small Signal Gain (Min.)	12.6	11.0	10.5	dB
—	Gain Flatness (Max.)	±0.3	±1.0	±1.0	dB
NF	Noise Figure (Max.)	5.0	6.0	6.5	dB
P _{1dB}	Power Output @ +1 dB Comp. (Min.)	+21.0	+20.0	+19.0	dBm
—	Input VSWR (Max.)	<1.3:1	2.0:1	2.0:1	—
—	Output VSWR (Max.)	<1.4:1	2.0:1	2.0:1	—
IP ₃	Two Tone 3rd Order Intercept Point	+35.0	—	—	dBm
IP ₂	Two Tone 2nd Order Intercept Point	+45.0	—	—	dBm
HP ₂	One Tone 2nd Harmonic Intercept Point	+49.0	—	—	dBm
I _D	DC Current	90	—	—	mA

Typical Performance Over Temperature (@ +15 VDC unless otherwise noted)

Key: +25°C —
 +85°C —
 -55°C —

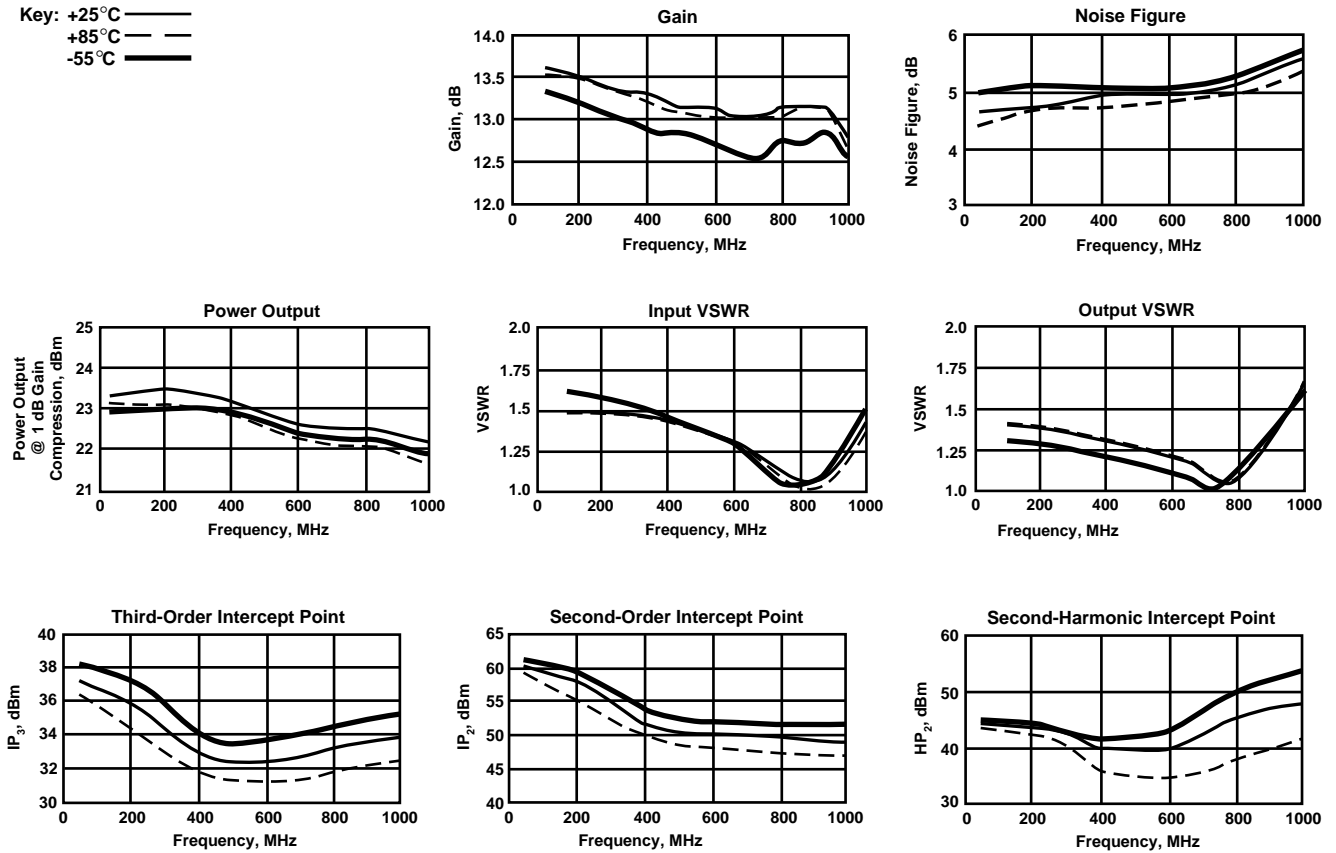

Automatic Network Analyzer Measurements (Typical production unit @ +25°C ambient)**Numerical Readings****Bias = 15.00 Volts**

FREQUENCY MHz	VSWR IN	GAIN dB	PHASE DEGREES	PHASE DEV	GROUP DELAY ns	VSWR OUT	ISOLATION dB
100.0	1.31	13.31	170.85	-.69	.00	1.07	17.87
150.0	1.30	13.14	164.96	-1.22	.32	1.08	18.09
200.0	1.29	13.04	159.42	-1.42	.31	1.09	18.06
250.0	1.29	12.97	153.67	-1.81	.30	1.09	18.05
300.0	1.28	12.83	148.73	-1.41	.27	1.09	18.10
350.0	1.28	12.74	143.94	-.85	.27	1.09	18.13
400.0	1.28	12.61	139.10	-.34	.27	1.10	18.23
450.0	1.26	12.53	134.09	.00	.27	1.09	18.35
500.0	1.24	12.50	129.46	.71	.26	1.09	18.43
550.0	1.23	12.52	124.83	1.43	.25	1.09	18.42
600.0	1.23	12.54	120.54	2.49	.24	1.10	18.67
650.0	1.25	12.57	116.05	3.35	.26	1.11	18.97
700.0	1.28	12.64	111.18	3.82	.28	1.12	19.36
750.0	1.32	12.73	106.07	4.05	.32	1.16	19.92
800.0	1.36	12.85	99.81	3.13	.36	1.21	20.64
850.0	1.38	13.05	93.14	1.80	.41	1.28	21.48
900.0	1.39	13.26	84.96	-1.02	.47	1.37	22.55
950.0	1.40	13.40	76.33	-4.31	.48	1.48	23.42
1000.0	1.43	13.55	67.57	-7.71	.54	1.60	23.46
1050.0	1.58	13.23	56.83	—	.58	1.71	22.69
1100.0	1.88	12.83	46.81	—	.57	1.82	21.94
1150.0	2.33	12.23	36.16	—	.57	1.86	21.29
1200.0	2.89	11.14	26.14	—	.48	1.87	20.77
1250.0	3.67	10.05	18.92	—	.44	1.84	20.56
1300.0	4.46	8.91	10.41	—	.41	1.79	20.66
1350.0	5.30	7.69	4.30	—	.32	1.73	20.75
1400.0	6.18	6.65	-.94	—	.28	1.65	21.57
1450.0	7.18	5.42	-5.89	—	.25	1.58	22.17
1500.0	8.43	4.21	-9.78	—	.20	1.52	22.53

LINEARIZATION RANGE: 100.0 to 1000.0 MHz

S-Parameters**Bias = 15.00 Volts**

FREQUENCY MHz	S ₁₁		S ₂₁		S ₁₂		S ₂₂	
	Mag	Ang	dB	Ang	dB	Ang	Mag	Ang
100.00	.124	-170.0	13.316	169.8	-17.967	-2.2	.035	134.5
200.00	.131	-173.2	13.075	158.9	-17.958	-5.8	.038	119.3
300.00	.125	-173.9	12.887	148.4	-18.079	-9.2	.039	110.2
400.00	.115	-173.0	12.661	138.7	-18.224	-13.8	.036	95.5
500.00	.105	-167.6	12.522	129.3	-18.430	-19.3	.031	67.1
600.00	.098	-155.6	12.569	120.5	-18.674	-25.6	.037	26.7
700.00	.125	-144.1	12.683	111.3	-19.272	-32.2	.067	-1.8
800.00	.163	-154.1	12.927	99.9	-20.491	-38.2	.117	-23.5
900.00	.180	174.0	13.272	85.4	-22.339	-37.6	.186	-43.9
1000.00	.180	113.1	13.495	68.5	-23.134	-25.1	.254	-67.1
1100.00	.279	36.6	12.796	48.5	-21.647	-19.5	.302	-91.7
1200.00	.466	-12.0	11.269	27.9	-20.486	-25.7	.303	-115.7
1300.00	.633	-43.3	9.129	12.0	-20.358	-38.0	.274	-139.4
1400.00	.738	-65.4	6.834	.3	-21.262	-49.5	.232	-160.6
1500.00	.808	-80.8	4.320	-8.8	-22.363	-56.4	.190	177.9
1600.00	.850	-91.9	1.955	-15.3	-23.876	-62.9	.157	154.1
1700.00	.867	-100.5	-.364	-20.7	-24.976	-66.2	.148	128.5
1800.00	.877	-107.4	-2.485	-25.6	-26.442	-64.4	.158	108.3
1900.00	.883	-113.5	-4.374	-27.8	-27.140	-66.2	.179	92.6
2000.00	.967	-121.7	-5.778	-29.8	-27.628	-67.5	.220	80.6
2100.00	.978	-126.0	-7.555	-30.8	-28.498	-63.7	.250	73.6
2200.00	.980	-130.0	-9.321	-33.3	-29.495	-64.5	.280	69.2
2300.00	.975	-133.7	-10.759	-35.1	-29.340	-67.4	.300	66.4
2400.00	.973	-137.8	-12.602	-36.9	-30.389	-68.3	.322	62.1
2500.00	.969	-141.1	-14.529	-37.1	-31.776	-61.6	.339	60.2

Product Options

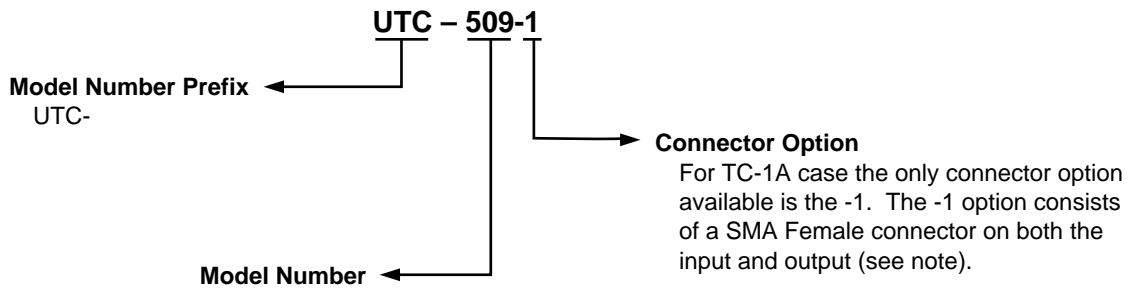
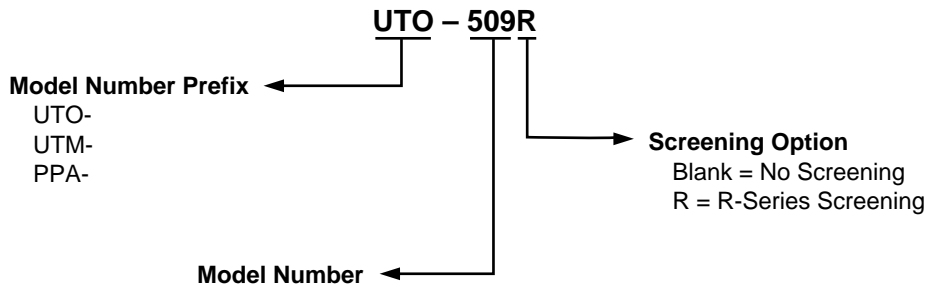

Note: R-Series screening is not available in the TC-1A case as the case is non-hermetic.

Case Drawings TO-8T

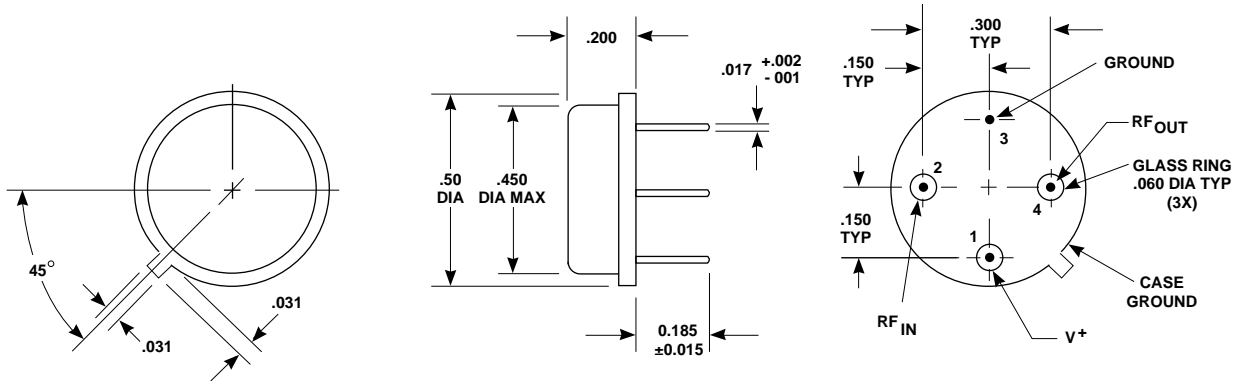

APPROXIMATE WEIGHT 2.1 GRAMS

- NOTES (UNLESS OTHERWISE SPECIFIED):**
 1. DIMENSIONS ARE SPECIFIED IN INCHES
 2. TOLERANCES: xx ± .02
 xxx ± .010

**Case Drawings
TC-1A**

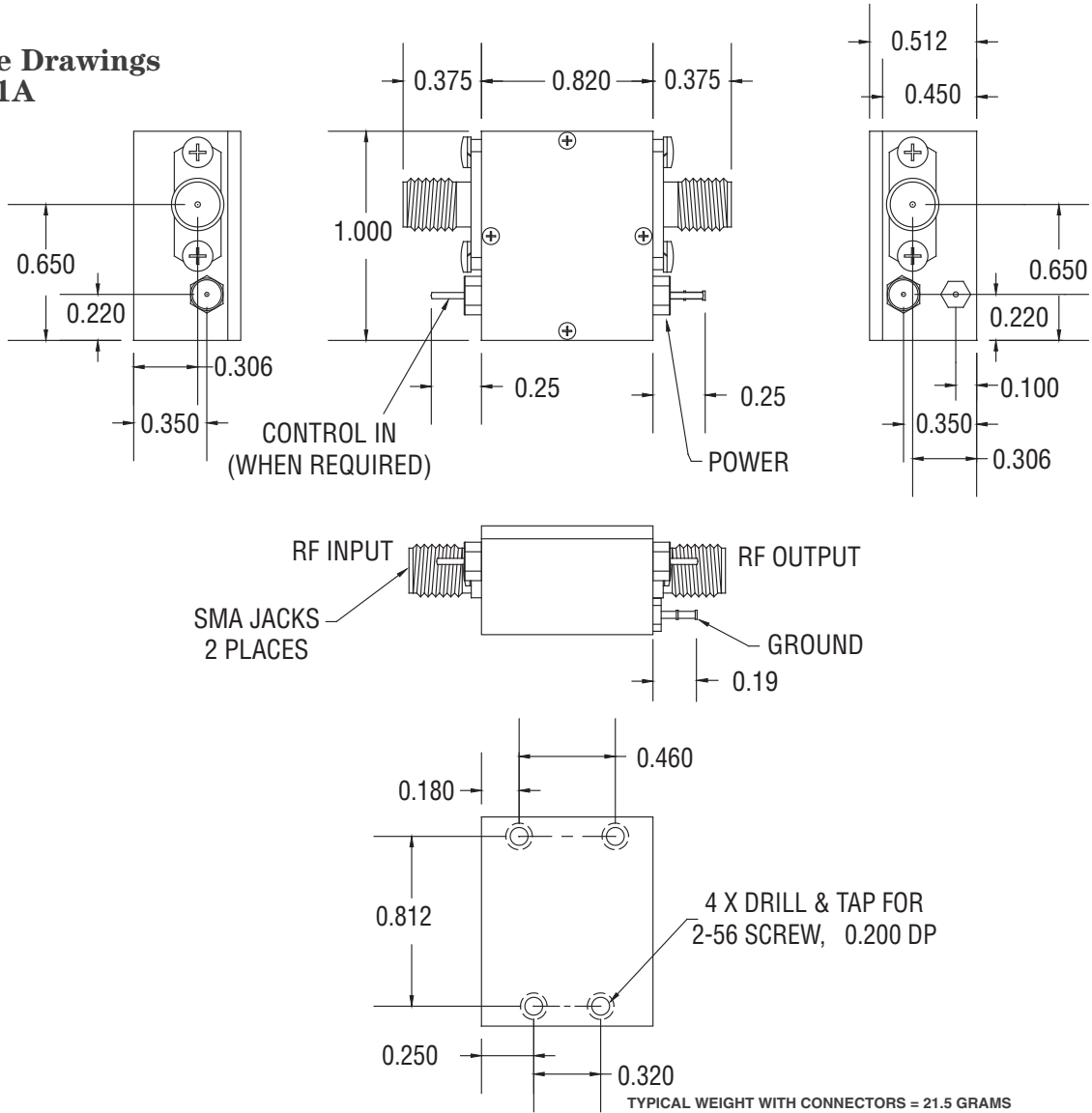

NOTES: 1. THE TC-1A CASE IS A NON-HERMETIC CASE.
2. THE ONLY CONNECTOR OPTION AVAILABLE FOR THE TC-1A CASE IS THE -1, SMA FEMALE CONNECTORS AT BOTH INPUT AND OUTPUT PORTS.

NOTES (UNLESS OTHERWISE SPECIFIED):
1. DIMENSIONS ARE SPECIFIED IN INCHES
2. TOLERANCES: xx ± .02
xxx ± .010

Contact Teledyne Cougar:
408-522-3838
408-522-3839 fax
cougaramps@cougarcorp.com

Check for updates:
www.teledyne-cougar.com