



Thin-Film Cascadable Amplifier 100 to 2000 MHz

Technical Data

UTO/UTC 2025 Series

Features

- **Frequency Range: 100 to 2000 MHz**
- **High Dynamic Range**
- **Medium Gain: 11.0 dB (Typ)**
- **Low Noise: 3.0 dB (Typ)**
- **High Power: +27 dBm (Typ)**
- **Temperature Compensated**

Applications

- **Power AMP Driver**
- **High Intercept Requirements**

Description

The 2025 Series is a wideband, high-power GaAs FET RF amplifier. The combination of high output power and low noise figure provide a unit with very high dynamic range. Active bias and resistive feedback provide for stability over temperature and bias voltage variations. Input/output blocking capacitors couple the RF through the amplifier, while a low VSWR is maintained through inductive tuning. The 2025 Series amplifiers are available in either the TO-8 hermetic case or connected TC-1A package.

Pin Configuration

UTO—TO-8T

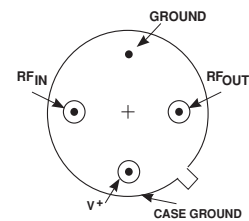

UTC—TC-1A

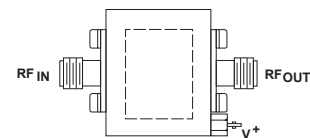

Schematic

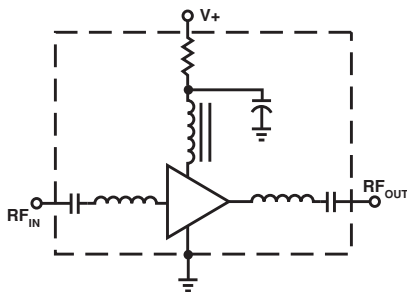

Maximum Ratings

Parameter	Maximum
DC Voltage	+17 Volts
Continuous RF Input Power	+19 dBm
Operating Case Temperature	-55 to +100°C
Storage Temperature	-62 to +150°C
“R” Series Burn-In Temperature	+100°C

Thermal Characteristics¹

θ_{JC}	36°C/W
Active Transistor Power Dissipation	1.28 W
Junction Temperature Above Case Temperature	46°C
MTBF (MIL-HDBK-217E, A_{UF} @ 90°C)	217,400 Hrs.

Weight: (typical) UTO—2.1 grams; UTC—21.5 grams

Electrical Specifications

(Measured in 50 Ω system @ +15 VDC nominal unless otherwise noted)

Symbol	Characteristic	Typical $T_C = 25^\circ\text{C}$	Guaranteed Specifications		Unit
			$T_C = 0 \text{ to } 50^\circ\text{C}$	$T_C = -55 \text{ to } +85^\circ\text{C}$	
BW	Frequency Range	100-2000	100-2000	100-2000	MHz
GP	Small Signal Gain (Min.)	11.0	9.5	9.0	dB
—	Gain Flatness (Max.)	± 0.3	± 1.0	± 1.0	dB
NF	Noise Figure (Max.)	3.0	4.5	5.5	dB
P _{1dB}	Power Output @ +1 dB Comp. (Min.)	+27.0	+25.0	+24.0	dBm
—	Input VSWR (Max.)	1.8:1	2.0:1	2.2:1	—
—	Output VSWR (Max.)	1.6:1	2.0:1	2.2:1	—
IP ₃	Two Tone 3rd Order Intercept Point	+37.0	+33.0	+32.0	dBm
IP ₂	Two Tone 2nd Order Intercept Point	+47.0	—	—	dBm
HP ₂	One Tone 2nd Harmonic Intercept Point	+53.0	—	—	dBm
I _D	DC Current	175	—	—	mA

Typical Performance Over Temperature (@ +15 VDC unless otherwise noted)

Key: +25°C —
+85°C - -
-55°C = =

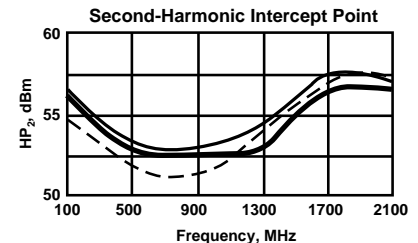
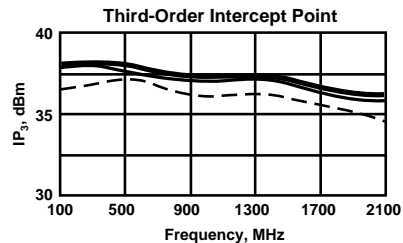
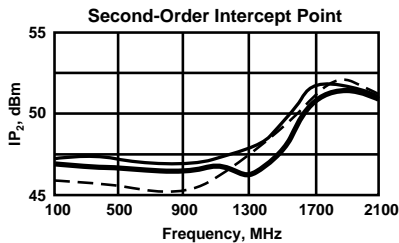
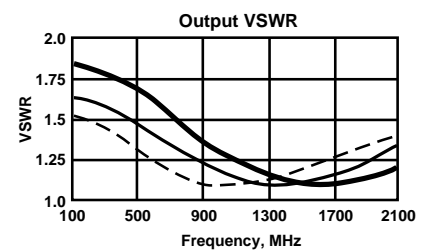
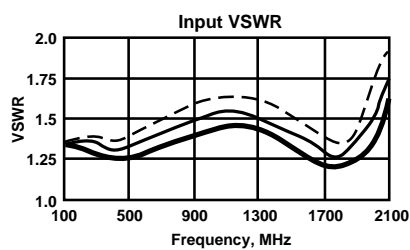
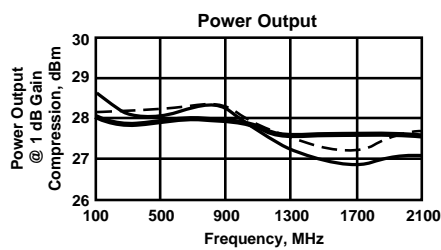
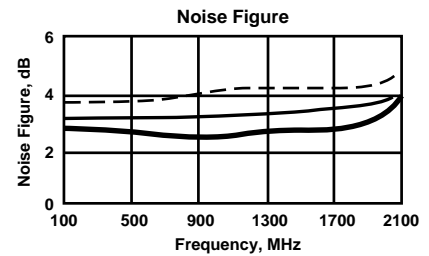
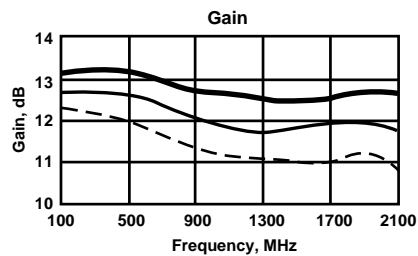

Automatic Network Analyzer Measurements (Typical production unit @ +25°C ambient)

S-Parameters Bias = 15.00 Volts
Current = 174.00 mA

FREQ GHz	S ₁₁		S ₂₁		S ₁₂		S ₂₂		K	GPDEL ns	PHASE DEG
	Mag	Ang	dB	Ang	dB	Ang	Mag	Ang			
.100	.14	-84.7	12.4	178.2	-19.0	-16.1	.25	-154.60	1.19	.42	4.85
.200	.11	-98.5	12.5	163.1	-19.5	-19.9	.24	179.85	1.25	.42	.24
.300	.11	-106.2	12.4	151.2	-19.7	-25.6	.23	165.70	1.28	.33	-1.20
.400	.12	-113.1	12.4	140.2	-19.8	-32.2	.22	155.30	1.31	.31	-1.81
.500	.14	-119.1	12.3	129.4	-20.0	-38.9	.20	145.84	1.34	.30	-2.10
.600	.15	-126.1	12.2	119.0	-20.2	-46.0	.18	137.12	1.38	.29	-2.07
.700	.17	-131.9	12.0	108.8	-20.3	-52.5	.15	128.88	1.41	.28	-1.78
.800	.18	-138.3	11.9	98.6	-20.5	-59.9	.12	120.30	1.45	.28	-1.56
.900	.20	-144.4	11.8	88.7	-20.7	-67.5	.09	110.25	1.49	.27	-.91
1.000	.21	-151.2	11.7	79.0	-20.8	-75.1	.07	99.02	1.54	.27	-.15
1.100	.22	-158.8	11.6	69.4	-21.1	-83.0	.04	81.92	1.58	.27	.69
1.200	.22	-167.1	11.5	59.6	-21.3	-91.2	.03	47.01	1.63	.27	1.39
1.300	.21	-176.1	11.5	49.6	-21.6	-99.2	.03	5.14	1.68	.28	1.78
1.400	.19	175.1	11.5	39.3	-21.9	-107.6	.05	-20.27	1.74	.29	1.96
1.500	.17	164.3	11.5	28.9	-22.1	-116.2	.06	-33.91	1.79	.29	2.06
1.600	.15	149.9	11.5	18.7	-22.3	-125.5	.07	-42.38	1.84	.28	2.29
1.700	.13	125.3	11.6	8.1	-22.5	-136.7	.06	-41.62	1.87	.29	2.17
1.800	.11	83.3	11.7	-3.9	-23.0	-148.1	.07	-33.15	1.95	.33	.66
1.900	.13	36.2	11.7	-16.8	-23.6	-159.1	.09	-34.26	2.05	.36	-1.81
2.000	.19	3.8	11.7	-30.1	-24.3	-170.1	.11	-42.50	2.18	.37	-4.68
2.100	.27	-17.4	11.5	-44.2	-25.0	178.7	.12	-56.05	2.30		
2.200	.36	-33.7	11.2	-58.9	-25.8	166.6	.13	-74.23	2.43		
2.300	.45	-47.7	10.8	-74.0	-26.9	153.9	.15	-95.76	2.62		
2.400	.53	-60.3	10.1	-89.3	-28.2	141.3	.18	-119.16	2.91		
2.500	.61	-71.9	9.2	-104.3	-29.9	129.0	.22	-140.94	3.37		
2.600	.67	-82.8	8.1	-118.8	-31.9	117.0	.27	-159.57	4.07		
2.700	.72	-93.0	6.8	-132.2	-34.7	105.7	.32	-175.10	5.51		
2.800	.76	-102.5	5.4	-144.2	-38.5	97.0	.36	171.81	8.54		
2.900	.79	-111.7	3.9	-155.0	-45.5	98.9	.40	160.79	19.57		
3.000	.81	-120.4	2.4	-164.1	-50.0	170.3	.42	151.48	34.63		
3.100	.82	-129.1	.9	-171.2	-42.6	-160.6	.43	143.46	16.06		
3.200	.82	-137.8	-.4	-178.6	-38.7	-164.4	.43	136.41	11.60		
3.300	.82	-146.5	-1.6	175.7	-36.0	-172.8	.42	130.31	9.76		
3.400	.82	-155.2	-2.6	170.6	-34.5	179.1	.40	124.76	9.47		
3.500	.82	-164.0	-3.4	165.0	-33.4	169.0	.37	119.78	9.50		
3.600	.82	-173.2	-4.1	159.1	-32.7	159.5	.34	115.25	9.79		
3.700	.82	177.8	-4.7	152.5	-32.1	150.0	.31	111.05	10.15		
3.800	.82	168.4	-5.3	144.9	-31.9	139.3	.29	107.01	10.70		
3.900	.82	159.0	-5.9	136.7	-31.8	129.7	.26	102.96	11.42		
4.000	.83	149.6	-6.5	127.6	-31.9	118.1	.24	99.62	12.38		

LINEARIZATION RANGE: .10 to 2.00 GHz

Product Options

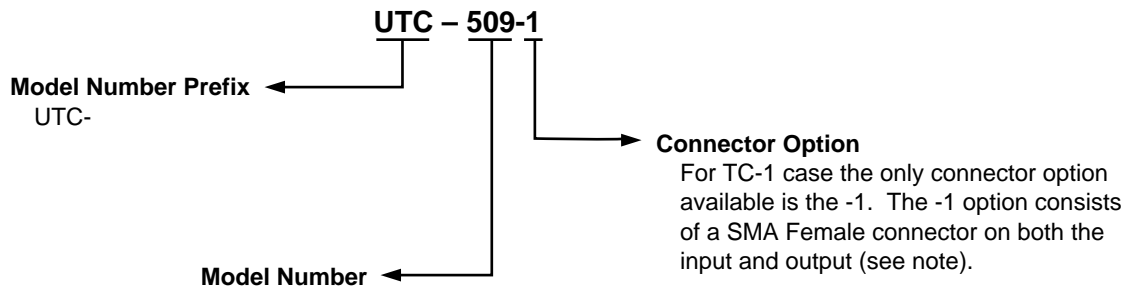
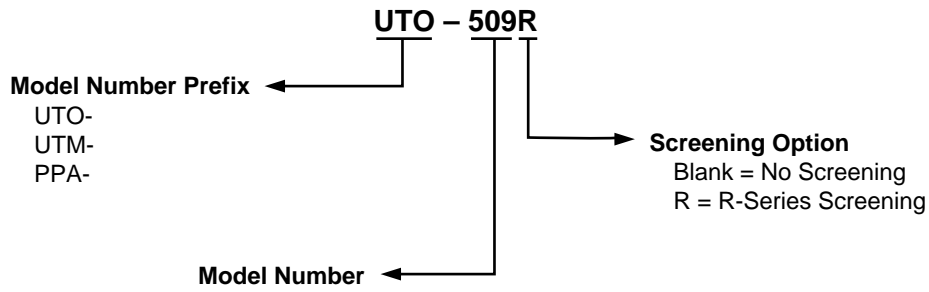

Note: R-Series screening is not available in the TC-1 case as the case is non-hermetic.

**Case Drawings
TO-8T**

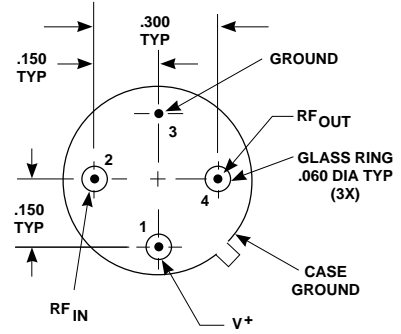
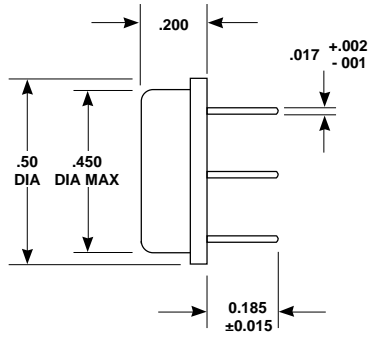
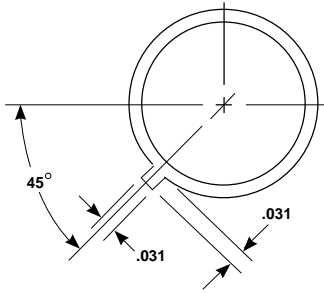

APPROXIMATE WEIGHT 2.1 GRAMS

- NOTES (UNLESS OTHERWISE SPECIFIED):**
 1. DIMENSIONS ARE SPECIFIED IN INCHES
 2. TOLERANCES: xx ± .02
 xxx ± .010

Case Drawings TC-1

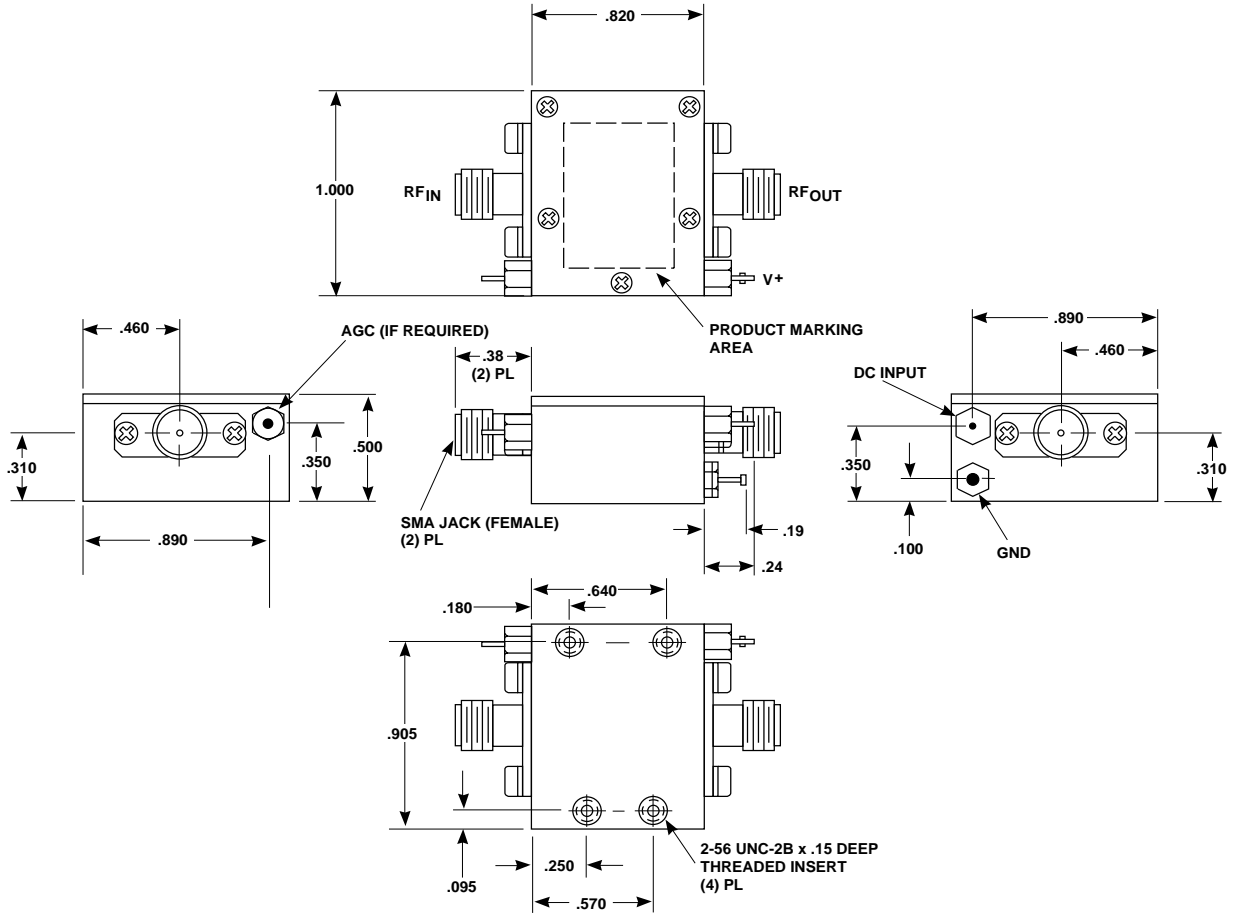

TYPICAL WEIGHT WITH CONNECTORS = 21.5 GRAMS

- NOTES: 1. THE TC-1 CASE IS A NON-HERMETIC CASE.
 2. THE ONLY CONNECTOR OPTION AVAILABLE FOR THE TC-1 CASE IS THE -1, SMA FEMALE CONNECTORS AT BOTH INPUT AND OUTPUT PORTS.

- NOTES (UNLESS OTHERWISE SPECIFIED):
 1. DIMENSIONS ARE SPECIFIED IN INCHES
 2. TOLERANCES: xx ± .02
 xxx ± .010

Contact Teledyne Microwave Solutions:
 650-691-9800
 650-962-6845 fax

Check for updates:
www.teledynemicrowave.com