

QUAD DIFFERENTIAL COMPARATOR

DESCRIPTION

The UTC339 consists of four independent voltage comparators designed specifically to operate from a single power supply over a wide voltage range.

FEATURES

- *Single or dual supply operation
- *Wide operating supply range($V_{CC}=2V\sim 36V$)
- *Input common-mode voltage includes ground
- *Low supply current drain $I_{CC}=0.8mA$ (Typical)
- *Open collector outputs for wired and connection
- *Low input bias current $I_{bias}=25nA$ (Typical)
- *Low output saturation voltage
- *Output compatible with TTL ,DTL, and CMOS logic system

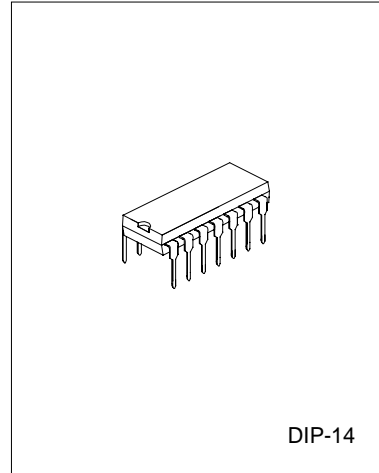

ABSOLUTE MAXIMUM RATINGS($T_a=25^\circ C$)

Characteristic	Symbol	Value	Unit
Supply Voltage	V_{CC}	± 18 OR 36	V
Differential input voltage	V_{IDiff}	36	V
Input Voltage	V_I	-0.3~36V	V
Power Dissipation	P_d	570	mW
Operating Temperature	T_{opr}	0 to +70	$^\circ C$
Storage Temperature	T_{stg}	-65 to 150	$^\circ C$

ELECTRICAL CHARACTERISTICS

($V_{CC}=5.0V$, $T_a=25^\circ C$, All voltage referenced to GND unless otherwise specified)

Characteristic	Symbol	Test Condition	Min	Typ.	Max	Unit
Input offset voltage	V_{io}	$V_{CM}=0$ to $V_{CC}-1.5$ $V_{o(p)}=1.4V, R_s=0$		± 1.5	± 5.0	mV
Input offset current	I_{io}			± 2.3	± 50	nA
Input Bias current	I_b			57	250	nA
Input Common-mode voltage range	$V_{I(R)}$		0		$V_{CC}-1.5$	V
Supply Current	I_{CC}	$R_L=\infty$		1.1	2.0	mA
Large signal Voltage Gain	G_v	$V_{CC}=15V, R_L>15k\Omega$	50	200		V/mV
Large signal response time	t_{res}	$V_i=TTL$ logic wing $V_{ref}=1.4V, V_{RL}=5V, R_L=5.1k\Omega$		350		ns
Response time	t_{res}	$V_{RL}=5V, R_L=5.1k\Omega$		1400		ns
Output sink current	I_{sink}	$V_i(-)>1V, V_i(+)=0V, V_o(p)<1.5V$	6	18		mA
Output saturation voltage	V_{sat}	$V_i(-)>1V, V_i(+)=0V, I_{sink}=4mA$	140	400		mV
output leakage current	$I_{leakage}$	$V_i(+)=1V, V_i(-)=0$	20	40		mA
Differential input voltage	$V_I(diff)$				36	V

BLOCK DIAGRAM

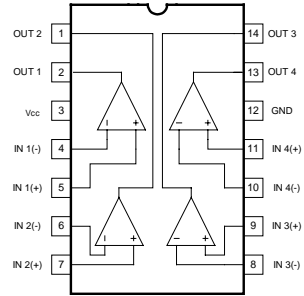
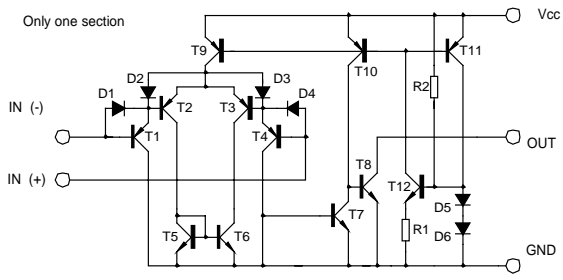

TYPICAL CHARACTERISTICS PERFORMANCE

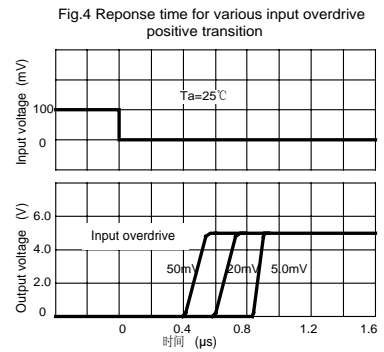
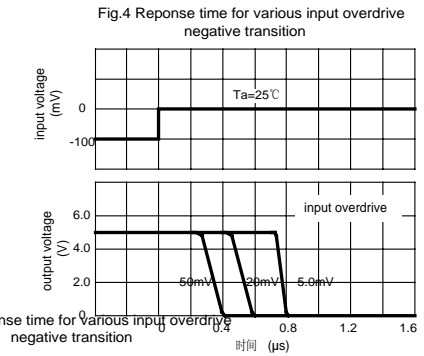
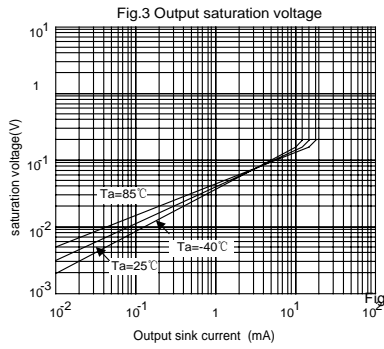
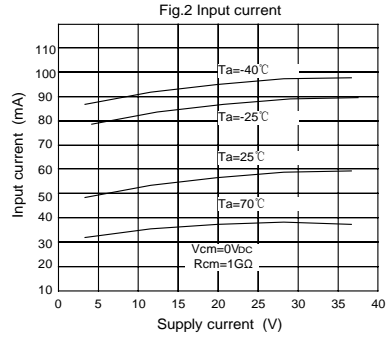
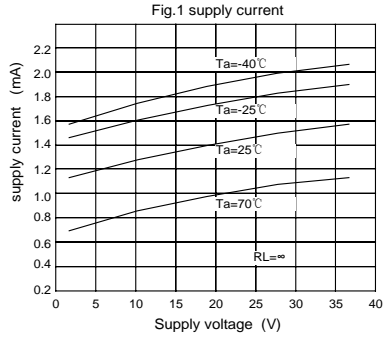

Fig.7

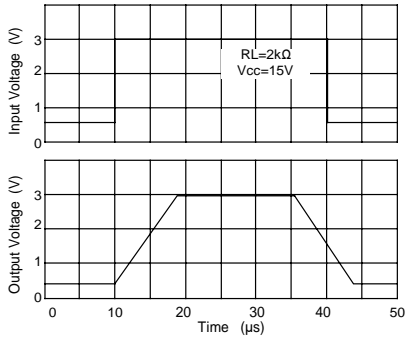

Fig.8 voltage Follower pulse response (small signal)

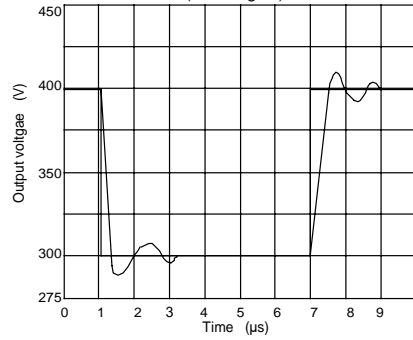

Fig.9 Large signal Frequency Response

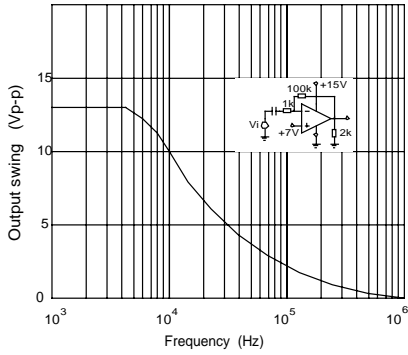

Fig.10 Output Characteristics current sourcing

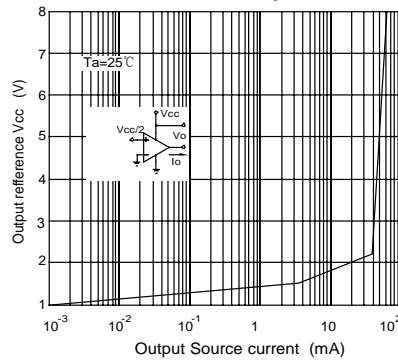

Fig.11 Output Characteristics Current sinking

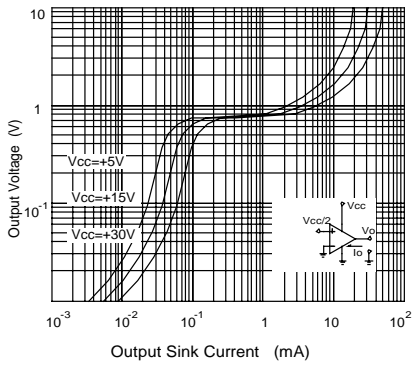

Fig.12 Current Limiting

